



# THE DATASHEET OF TPS2051ADR



# TPS2041A, TPS2042A, TPS2043A, TPS2044A TPS2051A, TPS2052A, TPS2053A, TPS2054A CURRENT-LIMITED POWER-DISTRIBUTION SWITCHES

SLVS247 – SEPTEMBER 2000

- 80-mΩ High-Side MOSFET Switch
- 500 mA Continuous Current Per Channel
- Independent Thermal and Short-Circuit Protection With Overcurrent Logic Output
- Operating Range . . . 2.7 V to 5.5 V
- CMOS- and TTL-Compatible Enable Inputs
- 2.5-ms Typical Rise Time
- Undervoltage Lockout
- 10 μA Maximum Standby Supply Current for Single and Dual (20 μA for Triple and Quad)
- Bidirectional Switch
- Ambient Temperature Range, 0°C to 85°C
- ESD Protection
- UL Listed – File No. E169910

## description

The TPS2041A through TPS2044A and TPS2051A through TPS2054A power-distribution switches are intended for applications where heavy capacitive loads and short circuits are likely to be encountered. These devices incorporate 80-mΩ N-channel MOSFET high-side power switches for power-distribution systems that require multiple power switches in a single package. Each switch is controlled by an independent logic enable input. Gate drive is provided by an internal charge pump designed to control the power-switch rise times and fall times to minimize current surges during switching. The charge pump requires no external components and allows operation from supplies as low as 2.7 V.

When the output load exceeds the current-limit threshold or a short is present, these devices limit the output current to a safe level by switching into a constant-current mode, pulling the overcurrent (OCx) logic output low. When continuous heavy overloads and short circuits increase the power dissipation in the switch, causing the junction temperature to rise, a thermal protection circuit shuts off the switch to prevent damage. Recovery from a thermal shutdown is automatic once the device has cooled sufficiently. Internal circuitry ensures the switch remains off until valid input voltage is present. These power-distribution switches are designed to current limit at 0.9 A.



† All enable inputs are active high for the TPS205xA series.  
NC – No connect

GENERAL SWITCH CATALOG					
<b>33 mΩ, single</b>  TPS201xA 0.2 A – 2 A TPS202x 0.2 A – 2 A TPS203x 0.2 A – 2 A	<b>80 mΩ, dual</b>  TPS2042 500 mA TPS2052 500 mA TPS2046 250 mA TPS2056 250 mA	<b>80 mΩ, dual</b>  TPS2080 500 mA TPS2081 500 mA TPS2082 500 mA TPS2090 250 mA TPS2091 250 mA TPS2092 250 mA	<b>80 mΩ, triple</b>  TPS2043 500 mA TPS2053 500 mA TPS2047 250 mA TPS2057 250 mA	<b>80 mΩ, quad</b>  TPS2044 500 mA TPS2054 500 mA TPS2048 250 mA TPS2058 250 mA	<b>80 mΩ, quad</b>  TPS2085 500 mA TPS2086 500 mA TPS2087 500 mA TPS2095 250 mA TPS2096 250 mA TPS2097 250 mA
<b>80 mΩ, single</b>  TPS2014 600 mA TPS2015 1 A TPS2041 500 mA TPS2051 500 mA TPS2045 250 mA TPS2055 250 mA	<b>260 mΩ</b>  IN1 IN2 OUT 1.3 Ω TPS2100/1 IN1 500 mA IN2 10 mA TPS2102/3/4/5 IN1 500 mA IN2 100 mA				



Please be aware that an important notice concerning availability, standard warranty, and use in critical applications of Texas Instruments semiconductor products and disclaimers thereto appears at the end of this data sheet.

PRODUCTION DATA information is current as of publication date. Products conform to specifications per the terms of Texas Instruments standard warranty. Production processing does not necessarily include testing of all parameters.

TEXAS INSTRUMENTS

POST OFFICE BOX 655303 • DALLAS, TEXAS 75265

Copyright © 2000, Texas Instruments Incorporated

TPS2041A, TPS2042A, TPS2043A, TPS2044A  
 TPS2051A, TPS2052A, TPS2053A, TPS2054A  
**CURRENT-LIMITED POWER-DISTRIBUTION SWITCHES**

SLVS247 – SEPTEMBER 2000

AVAILABLE OPTIONS

TA	ENABLE	RECOMMENDED MAXIMUM CONTINUOUS LOAD CURRENT (A)	TYPICAL SHORT-CIRCUIT CURRENT LIMIT AT 25°C (A)	NUMBER OF SWITCHES	PACKAGED DEVICES
					SOIC (D)†
0°C to 85°C	Active low	0.5	0.9	Single	TPS2041AD
	Active high				TPS2051AD
	Active low			Dual	TPS2042AD
	Active high				TPS2052AD
	Active low			Triple	TPS2043AD
	Active high				TPS2053AD
	Active low			Quad	TPS2044AD
	Active high				TPS2054AD

† The D package is available taped and reeled. Add an R suffix to device type (e.g., TPS2041ADR)



TPS2041A, TPS2042A, TPS2043A, TPS2044A  
 TPS2051A, TPS2052A, TPS2053A, TPS2054A  
 CURRENT-LIMITED POWER-DISTRIBUTION SWITCHES

SLVS247 – SEPTEMBER 2000

functional block diagrams

TPS2041A



† Current sense  
 ‡ Active high for TPS205xA series

TPS2042A



† Current sense  
 ‡ Active high for TPS205xA series



TPS2041A, TPS2042A, TPS2043A, TPS2044A  
 TPS2051A, TPS2052A, TPS2053A, TPS2054A  
**CURRENT-LIMITED POWER-DISTRIBUTION SWITCHES**

SLVS247 – SEPTEMBER 2000

functional block diagrams

TPS2043A



TPS2041A, TPS2042A, TPS2043A, TPS2044A  
 TPS2051A, TPS2052A, TPS2053A, TPS2054A  
 CURRENT-LIMITED POWER-DISTRIBUTION SWITCHES

SLVS247 – SEPTEMBER 2000

functional block diagrams

TPS2044A



† Current sense  
 ‡ Active high for TPS205xA series



TPS2041A, TPS2042A, TPS2043A, TPS2044A  
 TPS2051A, TPS2052A, TPS2053A, TPS2054A  
 CURRENT-LIMITED POWER-DISTRIBUTION SWITCHES

SLVS247 – SEPTEMBER 2000

Terminal Functions

TPS2041A and TPS2051A

NAME	TERMINAL		I/O	DESCRIPTION
	NO.			
	TPS2041A	TPS2051A		
$\overline{\text{EN}}$	4	–	I	Enable input. Logic low turns on power switch.
EN	–	4	I	Enable input. Logic high turns on power switch.
GND	1	1	I	Ground
IN	2, 3	2, 3	I	Input voltage
$\overline{\text{OC}}$	5	5	O	Overcurrent. Logic output active low
OUT	6, 7, 8	6, 7, 8	O	Power-switch output

TPS2042A and TPS2052A

NAME	TERMINAL		I/O	DESCRIPTION
	NO.			
	TPS2042A	TPS2052A		
$\overline{\text{EN1}}$	3	–	I	Enable input. Logic low turns on power switch, IN-OUT1.
$\overline{\text{EN2}}$	4	–	I	Enable input. Logic low turns on power switch, IN-OUT2.
EN1	–	3	I	Enable input. Logic high turns on power switch, IN-OUT1.
EN2	–	4	I	Enable input. Logic high turns on power switch, IN-OUT2.
GND	1	1	I	Ground
IN	2	2	I	Input voltage
$\overline{\text{OC1}}$	8	8	O	Overcurrent. Logic output active low, for power switch, IN-OUT1
$\overline{\text{OC2}}$	5	5	O	Overcurrent. Logic output active low, for power switch, IN-OUT2
OUT1	7	7	O	Power-switch output
OUT2	6	6	O	Power-switch output



**Terminal Functions (Continued)**

**TPS2043A and TPS2053A**

NAME	TERMINAL NO.		I/O	DESCRIPTION
	TPS2043A	TPS2053A		
	EN1	3		
EN2	4	–	I	Enable input, logic low turns on power switch, IN1-OUT2.
EN3	7	–	I	Enable input, logic low turns on power switch, IN2-OUT3.
EN1	–	3	I	Enable input, logic high turns on power switch, IN1-OUT1.
EN2	–	4	I	Enable input, logic high turns on power switch, IN1-OUT2.
EN3	–	7	I	Enable input, logic high turns on power switch, IN2-OUT3.
GNDA	1	1		Ground for IN1 switch and circuitry.
GNDB	5	5		Ground for IN2 switch and circuitry.
IN1	2	2	I	Input voltage
IN2	6	6	I	Input voltage
NC	8, 9, 10	8, 9, 10		No connection
OC1	16	16	O	Overcurrent, logic output active low, IN1-OUT1
OC2	13	13	O	Overcurrent, logic output active low, IN1-OUT2
OC3	12	12	O	Overcurrent, logic output active low, IN2-OUT3
OUT1	15	15	O	Power-switch output, IN1-OUT1
OUT2	14	14	O	Power-switch output, IN1-OUT2
OUT3	11	11	O	Power-switch output, IN2-OUT3

**TPS2044A and TPS2054A**

NAME	TERMINAL NO.		I/O	DESCRIPTION
	TPS2044A	TPS2054A		
	EN1	3		
EN2	4	–	I	Enable input. Logic low turns on power switch, IN1-OUT2.
EN3	7	–	I	Enable input. Logic low turns on power switch, IN2-OUT3.
EN4	8	–	I	Enable input. Logic low turns on power switch, IN2-OUT4.
EN1	–	3	I	Enable input. Logic high turns on power switch, IN1-OUT1.
EN2	–	4	I	Enable input. Logic high turns on power switch, IN1-OUT2.
EN3	–	7	I	Enable input. Logic high turns on power switch, IN2-OUT3.
EN4	–	8	I	Enable input. Logic high turns on power switch, IN2-OUT4.
GNDA	1	1		Ground for IN1 switch and circuitry.
GNDB	5	5		Ground for IN2 switch and circuitry.
IN1	2	2	I	Input voltage
IN2	6	6	I	Input voltage
OC1	16	16	O	Overcurrent. Logic output active low, IN1-OUT1
OC2	13	13	O	Overcurrent. Logic output active low, IN1-OUT2
OC3	12	12	O	Overcurrent. Logic output active low, IN2-OUT3
OC4	9	9	O	Overcurrent. Logic output active low, IN2-OUT4
OUT1	15	15	O	Power-switch output, IN1-OUT1
OUT2	14	14	O	Power-switch output, IN1-OUT2
OUT3	11	11	O	Power-switch output, IN2-OUT3
OUT4	10	10	O	Power-switch output, IN2-OUT4

# TPS2041A, TPS2042A, TPS2043A, TPS2044A TPS2051A, TPS2052A, TPS2053A, TPS2054A CURRENT-LIMITED POWER-DISTRIBUTION SWITCHES

SLVS247 – SEPTEMBER 2000

---

## detailed description

### power switch

The power switch is an N-channel MOSFET with a maximum on-state resistance of 135 m $\Omega$  ( $V_{I(IN)} = 5$  V). Configured as a high-side switch, the power switch prevents current flow from OUT to IN and IN to OUT when disabled. The power switch supplies a minimum of 500 mA per switch.

### charge pump

An internal charge pump supplies power to the driver circuit and provides the necessary voltage to pull the gate of the MOSFET above the source. The charge pump operates from input voltages as low as 2.7 V and requires very little supply current.

### driver

The driver controls the gate voltage of the power switch. To limit large current surges and reduce the associated electromagnetic interference (EMI) produced, the driver incorporates circuitry that controls the rise times and fall times of the output voltage. The rise and fall times are typically in the 2-ms to 4-ms range.

### enable ( $\overline{ENx}$ , ENx)

The logic enable disables the power switch and the bias for the charge pump, driver, and other circuitry to reduce the supply current. The supply current is reduced to less than 10  $\mu$ A on the single and dual devices (20  $\mu$ A on the triple and quad devices) when a logic high is present on  $\overline{ENx}$  (TPS204xA†) or a logic low is present on ENx (TPS205xA†). A logic zero input on  $\overline{ENx}$  or a logic high on ENx restores bias to the drive and control circuits and turns the power on. The enable input is compatible with both TTL and CMOS logic levels.

### overcurrent ( $\overline{OCx}$ )

The  $\overline{OCx}$  open-drain output is asserted (active low) when an overcurrent or overtemperature condition is encountered. The output will remain asserted until the overcurrent or overtemperature condition is removed.

### current sense

A sense FET monitors the current supplied to the load. The sense FET measures current more efficiently than conventional resistance methods. When an overload or short circuit is encountered, the current-sense circuitry sends a control signal to the driver. The driver in turn reduces the gate voltage and drives the power FET into its saturation region, which switches the output into a constant-current mode and holds the current constant while varying the voltage on the load.

### thermal sense

The TPS204xA and TPS205xA implement a dual-threshold thermal trip to allow fully independent operation of the power distribution switches. In an overcurrent or short-circuit condition the junction temperature rises. When the die temperature rises to approximately 140°C, the internal thermal sense circuitry checks to determine which power switch is in an overcurrent condition and turns off that switch, thus isolating the fault without interrupting operation of the adjacent power switch. Hysteresis is built into the thermal sense, and after the device has cooled approximately 20 degrees, the switch turns back on. The switch continues to cycle off and on until the fault is removed. The ( $\overline{OCx}$ ) open-drain output is asserted (active low) when overtemperature or overcurrent occurs.

### undervoltage lockout

A voltage sense circuit monitors the input voltage. When the input voltage is below approximately 2 V, a control signal turns off the power switch.

† Product series designations TPS204x and TPS205x refer to devices presented in this data sheet and not necessarily to other TI devices numbered in this sequence.

**TPS2041A, TPS2042A, TPS2043A, TPS2044A  
TPS2051A, TPS2052A, TPS2053A, TPS2054A  
CURRENT-LIMITED POWER-DISTRIBUTION SWITCHES**

SLVS247 – SEPTEMBER 2000

**absolute maximum ratings over operating free-air temperature range (unless otherwise noted)†**

Input voltage range, $V_{I(IN)}$ (see Note 1) .....	–0.3 V to 6 V
Output voltage range, $V_{O(OUT)}$ (see Note 1) .....	–0.3 V to $V_{I(IN)} + 0.3$ V
Input voltage range, $V_{I(ENx)}$ or $V_{I(ENx)}$ .....	–0.3 V to 6 V
Continuous output current, $I_{O(OUT)}$ .....	internally limited
Continuous total power dissipation .....	See Dissipation Rating Table
Operating virtual junction temperature range, $T_J$ .....	0°C to 125°C
Storage temperature range, $T_{stg}$ .....	–65°C to 150°C
Lead temperature soldering 1,6 mm (1/16 inch) from case for 10 seconds .....	260°C
Electrostatic discharge (ESD) protection: Human body model MIL-STD-883C .....	2 kV
Machine model .....	0.2 kV

† Stresses beyond those listed under “absolute maximum ratings” may cause permanent damage to the device. These are stress ratings only, and functional operation of the device at these or any other conditions beyond those indicated under “recommended operating conditions” is not implied. Exposure to absolute-maximum-rated conditions for extended periods may affect device reliability.

NOTE 1: All voltages are with respect to GND.

**DISSIPATION RATING TABLE**

PACKAGE	$T_A \leq 25^\circ\text{C}$ POWER RATING	DERATING FACTOR ABOVE $T_A = 25^\circ\text{C}$	$T_A = 70^\circ\text{C}$ POWER RATING	$T_A = 85^\circ\text{C}$ POWER RATING
D–8	725 mW	5.9 mW/°C	464 mW	377 mW
D–16	1123 mW	9 mW/°C	719 mW	584 mW

**recommended operating conditions**

	MIN	MAX	UNIT
Input voltage, $V_{I(IN)}$	2.7	5.5	V
Input voltage, $V_{I(EN)}$ or $V_{I(EN)}$	0	5.5	V
Continuous output current, $I_{O(OUT)}$ (per switch)	0	500	mA
Operating virtual junction temperature, $T_J$	0	125	°C



TPS2041A, TPS2042A, TPS2043A, TPS2044A  
 TPS2051A, TPS2052A, TPS2053A, TPS2054A  
 CURRENT-LIMITED POWER-DISTRIBUTION SWITCHES

SLVS247 – SEPTEMBER 2000

electrical characteristics over recommended operating junction temperature range,  $V_{I(IN)} = 5.5\text{ V}$ ,  $I_O = \text{rated current}$ ,  $V_{I(EN)} = 0\text{ V}$ ,  $V_{I(EN)} = V_{I(IN)}$  (unless otherwise noted)

power switch

PARAMETER		TEST CONDITION†	TPS204xA			TPS205xA			UNIT
			MIN	TYP	MAX	MIN	TYP	MAX	
$r_{DS(on)}$	Static drain-source on-state resistance, 5-V operation	$V_{I(IN)} = 5\text{ V}$ , $T_J = 25^\circ\text{C}$ , $I_O = 0.5\text{ A}$	80	100		80	100	m $\Omega$	
		$V_{I(IN)} = 5\text{ V}$ , $T_J = 85^\circ\text{C}$ , $I_O = 0.5\text{ A}$	90	120		90	120		
		$V_{I(IN)} = 5\text{ V}$ , $T_J = 125^\circ\text{C}$ , $I_O = 0.5\text{ A}$	100	135		100	135		
	Static drain-source on-state resistance, 3.3-V operation	$V_{I(IN)} = 3.3\text{ V}$ , $T_J = 25^\circ\text{C}$ , $I_O = 0.5\text{ A}$	90	125		90	125		
		$V_{I(IN)} = 3.3\text{ V}$ , $T_J = 85^\circ\text{C}$ , $I_O = 0.5\text{ A}$	110	145		110	145		
		$V_{I(IN)} = 3.3\text{ V}$ , $T_J = 125^\circ\text{C}$ , $I_O = 0.5\text{ A}$	120	160		120	160		
$t_r$	Rise time, output	$V_{I(IN)} = 5.5\text{ V}$ , $T_J = 25^\circ\text{C}$ , $C_L = 1\text{ }\mu\text{F}$ , $R_L = 10\text{ }\Omega$	2.5			2.5		ms	
		$V_{I(IN)} = 2.7\text{ V}$ , $T_J = 25^\circ\text{C}$ , $C_L = 1\text{ }\mu\text{F}$ , $R_L = 10\text{ }\Omega$	3			3			
$t_f$	Fall time, output	$V_{I(IN)} = 5.5\text{ V}$ , $T_J = 25^\circ\text{C}$ , $C_L = 1\text{ }\mu\text{F}$ , $R_L = 10\text{ }\Omega$	4.4			4.4		ms	
		$V_{I(IN)} = 2.7\text{ V}$ , $T_J = 25^\circ\text{C}$ , $C_L = 1\text{ }\mu\text{F}$ , $R_L = 10\text{ }\Omega$	2.5			2.5			

† Pulse-testing techniques maintain junction temperature close to ambient temperature; thermal effects must be taken into account separately.

enable input  $\overline{ENx}$  or  $ENx$

PARAMETER		TEST CONDITIONS	TPS204xA			TPS205xA			UNIT
			MIN	TYP	MAX	MIN	TYP	MAX	
$V_{IH}$	High-level input voltage	$2.7\text{ V} \leq V_{I(IN)} \leq 5.5\text{ V}$	2			2			V
$V_{IL}$	Low-level input voltage	$4.5\text{ V} \leq V_{I(IN)} \leq 5.5\text{ V}$			0.8			0.8	V
		$2.7\text{ V} \leq V_{I(IN)} \leq 4.5\text{ V}$			0.4			0.4	
$I_I$	Input current	TPS204xA $V_{I(ENx)} = 0\text{ V}$ or $V_{I(ENx)} = V_{I(IN)}$	-0.5		0.5				$\mu\text{A}$
		TPS205xA $V_{I(ENx)} = V_{I(IN)}$ or $V_{I(ENx)} = 0\text{ V}$				-0.5		0.5	
$t_{on}$	Turnon time	$C_L = 100\text{ }\mu\text{F}$ , $R_L = 10\text{ }\Omega$			20			20	ms
$t_{off}$	Turnoff time	$C_L = 100\text{ }\mu\text{F}$ , $R_L = 10\text{ }\Omega$			40			40	ms

current limit

PARAMETER		TEST CONDITION†	TPS204xA			TPS205xA			UNIT
			MIN	TYP	MAX	MIN	TYP	MAX	
$I_{OS}$	Short-circuit output current	$V_{I(IN)} = 5\text{ V}$ , OUT connected to GND, Device enabled into short circuit	0.7	1	1.3	0.7	1	1.3	A

† Pulse-testing techniques maintain junction temperature close to ambient temperature; thermal effects must be taken into account separately.



**TPS2041A, TPS2042A, TPS2043A, TPS2044A  
TPS2051A, TPS2052A, TPS2053A, TPS2054A  
CURRENT-LIMITED POWER-DISTRIBUTION SWITCHES**

SLVS247 – SEPTEMBER 2000

electrical characteristics over recommended operating junction temperature range,  $V_{I(IN)} = 5.5\text{ V}$ ,  $I_O = \text{rated current}$ ,  $V_{I(EN)} = 0\text{ V}$ ,  $V_{I(EN)} = V_{I(IN)}$  (unless otherwise noted) (continued)

**supply current (TPS2041A, TPS2051A)**

PARAMETER	TEST CONDITIONS			TPS2041A			TPS2051A			UNIT
				MIN	TYP	MAX	MIN	TYP	MAX	
Supply current, low-level output	No Load on OUT	$\overline{V_{I(EN)}} = V_{I(IN)}$	$T_J = 25^\circ\text{C}$	0.025	1				$\mu\text{A}$	
			$-40^\circ\text{C} \leq T_J \leq 125^\circ\text{C}$			10				
		$V_{I(EN)} = 0\text{ V}$	$T_J = 25^\circ\text{C}$			0.025	1			
			$-40^\circ\text{C} \leq T_J \leq 125^\circ\text{C}$					10		
Supply current, high-level output	No Load on OUT	$\overline{V_{I(EN)}} = 0\text{ V}$	$T_J = 25^\circ\text{C}$	85	110			$\mu\text{A}$		
			$-40^\circ\text{C} \leq T_J \leq 125^\circ\text{C}$			100				
		$V_{I(EN)} = V_{I(IN)}$	$T_J = 25^\circ\text{C}$			85	110			
			$-40^\circ\text{C} \leq T_J \leq 125^\circ\text{C}$						100	
Leakage current	OUT connected to ground	$\overline{V_{I(EN)}} = V_{I(IN)}$	$-40^\circ\text{C} \leq T_J \leq 125^\circ\text{C}$	100				$\mu\text{A}$		
		$V_{I(EN)} = 0\text{ V}$	$-40^\circ\text{C} \leq T_J \leq 125^\circ\text{C}$			100				
Reverse leakage current	IN = High impedance	$\overline{V_{I(EN)}} = 0\text{ V}$	$T_J = 25^\circ\text{C}$	0.3				$\mu\text{A}$		
		$V_{I(EN)} = V_{I(IN)}$					0.3			

**supply current (TPS2042A, TPS2052A)**

PARAMETER	TEST CONDITIONS			TPS2042A			TPS2052A			UNIT
				MIN	TYP	MAX	MIN	TYP	MAX	
Supply current, low-level output	No Load on OUT	$\overline{V_{I(ENx)}} = V_{I(IN)}$	$T_J = 25^\circ\text{C}$	0.025	1			$\mu\text{A}$		
			$-40^\circ\text{C} \leq T_J \leq 125^\circ\text{C}$			10				
		$V_{I(ENx)} = 0\text{ V}$	$T_J = 25^\circ\text{C}$			0.025	1			
			$-40^\circ\text{C} \leq T_J \leq 125^\circ\text{C}$						10	
Supply current, high-level output	No Load on OUT	$\overline{V_{I(ENx)}} = 0\text{ V}$	$T_J = 25^\circ\text{C}$	85	110			$\mu\text{A}$		
			$-40^\circ\text{C} \leq T_J \leq 125^\circ\text{C}$			100				
		$V_{I(ENx)} = V_{I(IN)}$	$T_J = 25^\circ\text{C}$			85	110			
			$-40^\circ\text{C} \leq T_J \leq 125^\circ\text{C}$						100	
Leakage current	OUT connected to ground	$\overline{V_{I(ENx)}} = V_{I(IN)}$	$-40^\circ\text{C} \leq T_J \leq 125^\circ\text{C}$	100				$\mu\text{A}$		
		$V_{I(ENx)} = 0\text{ V}$	$-40^\circ\text{C} \leq T_J \leq 125^\circ\text{C}$			100				
Reverse leakage current	IN = high impedance	$\overline{V_{I(EN)}} = 0\text{ V}$	$T_J = 25^\circ\text{C}$	0.3				$\mu\text{A}$		
		$V_{I(EN)} = V_{I(IN)}$					0.3			

TPS2041A, TPS2042A, TPS2043A, TPS2044A  
 TPS2051A, TPS2052A, TPS2053A, TPS2054A  
 CURRENT-LIMITED POWER-DISTRIBUTION SWITCHES

SLVS247 – SEPTEMBER 2000

electrical characteristics over recommended operating junction temperature range,  $V_{I(IN)} = 5.5\text{ V}$ ,  $I_O = \text{rated current}$ ,  $V_{I(EN)} = 0\text{ V}$ ,  $V_{I(EN)} = V_{I(IN)}$  (unless otherwise noted) (continued)

supply current (TPS2043A, TPS2053A)

PARAMETER	TEST CONDITIONS		TPS2043A			TPS2053A			UNIT
			MIN	TYP	MAX	MIN	TYP	MAX	
Supply current, low-level output	No Load on OUTx	$\overline{V_{I(ENx)}} = V_{I(INx)}$	$T_J = 25^\circ\text{C}$	0.05	2			$\mu\text{A}$	
			$-40^\circ\text{C} \leq T_J \leq 125^\circ\text{C}$		20				
		$V_{I(ENx)} = 0\text{ V}$	$T_J = 25^\circ\text{C}$			0.05	2		
			$-40^\circ\text{C} \leq T_J \leq 125^\circ\text{C}$				20		
Supply current, high-level output	No Load on OUTx	$\overline{V_{I(ENx)}} = 0\text{ V}$	$T_J = 25^\circ\text{C}$	160	200			$\mu\text{A}$	
			$-40^\circ\text{C} \leq T_J \leq 125^\circ\text{C}$		200				
		$V_{I(ENx)} = V_{I(INx)}$	$T_J = 25^\circ\text{C}$			160	200		
			$-40^\circ\text{C} \leq T_J \leq 125^\circ\text{C}$				200		
Leakage current	OUTx connected to ground	$\overline{V_{I(ENx)}} = V_{I(INx)}$	$-40^\circ\text{C} \leq T_J \leq 125^\circ\text{C}$	200				$\mu\text{A}$	
		$V_{I(ENx)} = 0\text{ V}$	$-40^\circ\text{C} \leq T_J \leq 125^\circ\text{C}$			200			
Reverse leakage current	IN = high impedance	$V_{I(ENx)} = 0\text{ V}$	$T_J = 25^\circ\text{C}$	0.3				$\mu\text{A}$	
		$V_{I(ENx)} = V_{I(IN)}$				0.3			

supply current (TPS2044A, TPS2054A)

PARAMETER	TEST CONDITIONS		TPS2044A			TPS2054A			UNIT
			MIN	TYP	MAX	MIN	TYP	MAX	
Supply current, low-level output	No Load on OUTx	$\overline{V_{I(ENx)}} = V_{I(INx)}$	$T_J = 25^\circ\text{C}$	0.05	2			$\mu\text{A}$	
			$-40^\circ\text{C} \leq T_J \leq 125^\circ\text{C}$		20				
		$V_{I(ENx)} = 0\text{ V}$	$T_J = 25^\circ\text{C}$			0.05	2		
			$-40^\circ\text{C} \leq T_J \leq 125^\circ\text{C}$				20		
Supply current, high-level output	No Load on OUTx	$\overline{V_{I(ENx)}} = 0\text{ V}$	$T_J = 25^\circ\text{C}$	170	220			$\mu\text{A}$	
			$-40^\circ\text{C} \leq T_J \leq 125^\circ\text{C}$		200				
		$V_{I(ENx)} = V_{I(INx)}$	$T_J = 25^\circ\text{C}$			170	220		
			$-40^\circ\text{C} \leq T_J \leq 125^\circ\text{C}$				200		
Leakage current	OUTx connected to ground	$\overline{V_{I(ENx)}} = V_{I(INx)}$	$-40^\circ\text{C} \leq T_J \leq 125^\circ\text{C}$	200				$\mu\text{A}$	
		$V_{I(ENx)} = 0\text{ V}$	$-40^\circ\text{C} \leq T_J \leq 125^\circ\text{C}$			200			
Reverse leakage current	IN = high impedance	$V_{I(EN)} = 0\text{ V}$	$T_J = 25^\circ\text{C}$	0.3				$\mu\text{A}$	
		$V_{I(EN)} = V_{I(IN)}$				0.3			

undervoltage lockout

PARAMETER	TEST CONDITIONS	TPS204xA			TPS205xA			UNIT
		MIN	TYP	MAX	MIN	TYP	MAX	
Low-level input voltage		2		2.5	2		2.5	V
Hysteresis	$T_J = 25^\circ\text{C}$		100			100		mV

overcurrent  $\overline{OC}$

PARAMETER	TEST CONDITIONS	TPS204xA			TPS205xA			UNIT
		MIN	TYP	MAX	MIN	TYP	MAX	
Sink current <sup>†</sup>	$V_O = 5\text{ V}$			10			10	mA
Output low voltage	$I_O = 5\text{ V}$ , $\overline{V_{OL(OC)}}$			0.5			0.5	V
Off-state current <sup>†</sup>	$V_O = 5\text{ V}$ , $V_O = 3.3\text{ V}$			1			1	$\mu\text{A}$

<sup>†</sup> Specified by design, not production tested.



PARAMETER MEASUREMENT INFORMATION

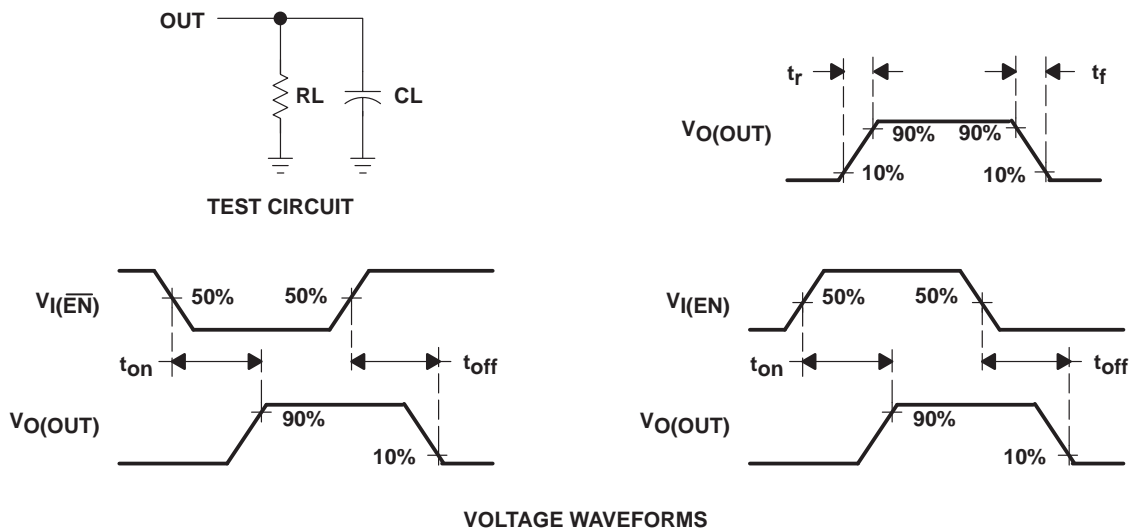

Figure 1. Test Circuit and Voltage Waveforms



Figure 2. Turnon Delay and Rise Time with 0.1- $\mu$ F Load



Figure 3. Turnoff Delay and Fall Time with 0.1- $\mu$ F Load

PARAMETER MEASUREMENT INFORMATION

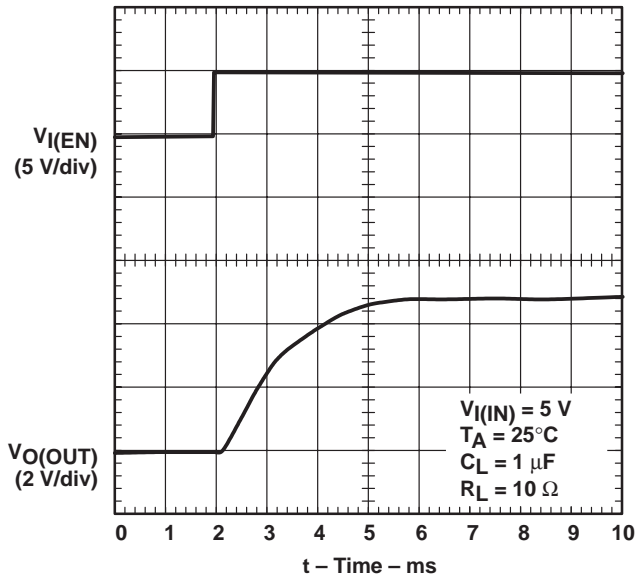

Figure 4. Turnon Delay and Rise Time with 1-µF Load

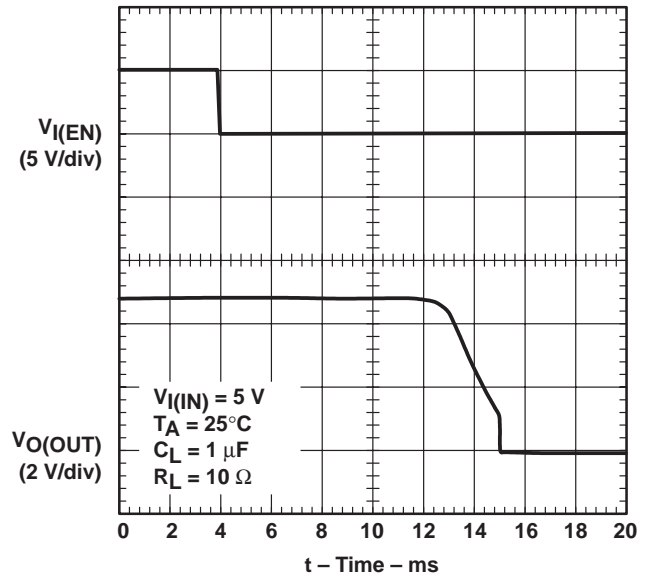

Figure 5. Turnoff Delay and Fall Time with 1-µF Load

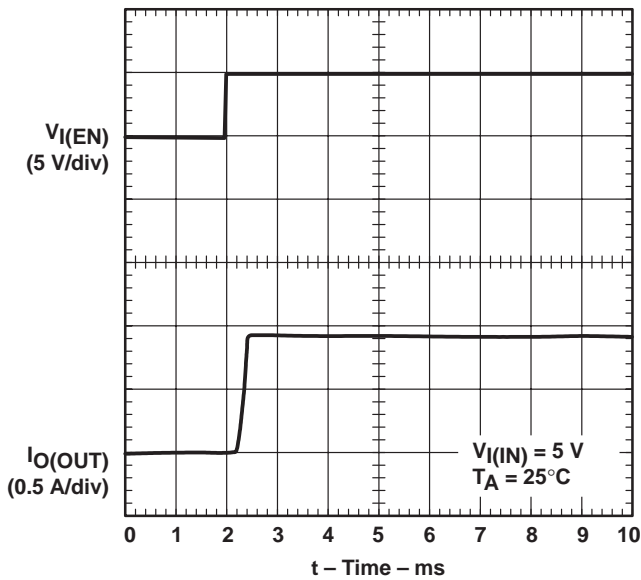

Figure 6. TPS2051A, Short-Circuit Current, Device Enabled into Short

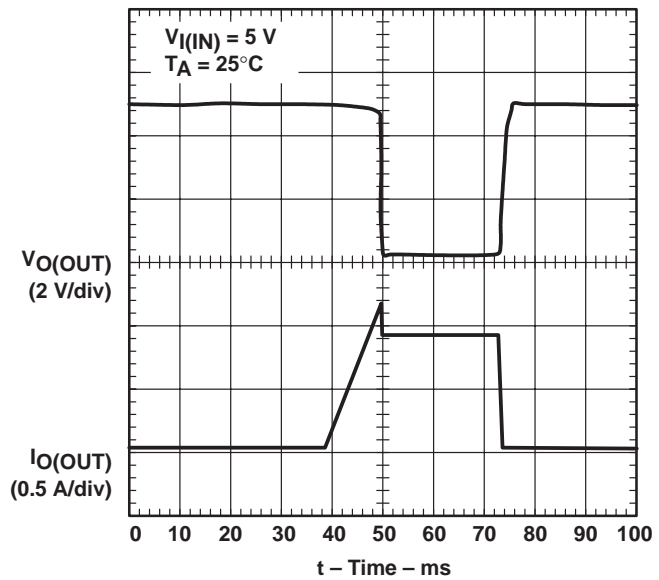

Figure 7. TPS2051A, Threshold Trip Current with Ramped Load on Enabled Device

PARAMETER MEASUREMENT INFORMATION



Figure 8. OC Response With Ramped Load on Enabled Device



Figure 9. Inrush Current with 100- $\mu$ F, 220- $\mu$ F and 470- $\mu$ F Load Capacitance



Figure 10. 4- $\Omega$  Load Connected to Enabled Device



Figure 11. 1- $\Omega$  Load Connected to Enabled Device

TYPICAL CHARACTERISTICS

TURNON DELAY TIME  
 vs  
 INPUT VOLTAGE

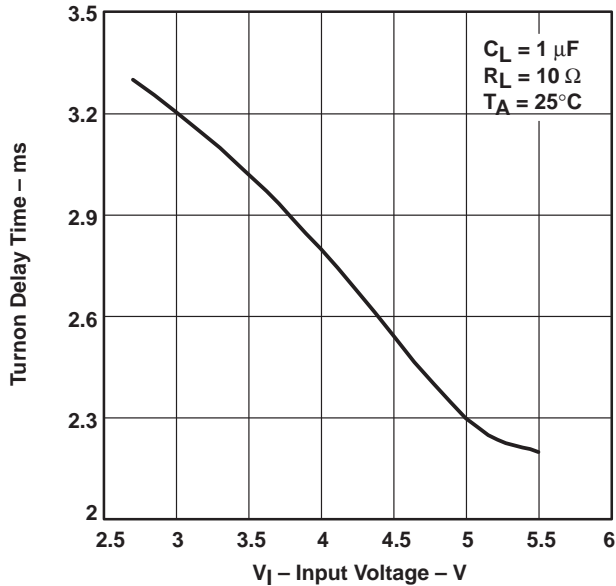

Figure 12

TURNOFF DELAY TIME  
 vs  
 INPUT VOLTAGE

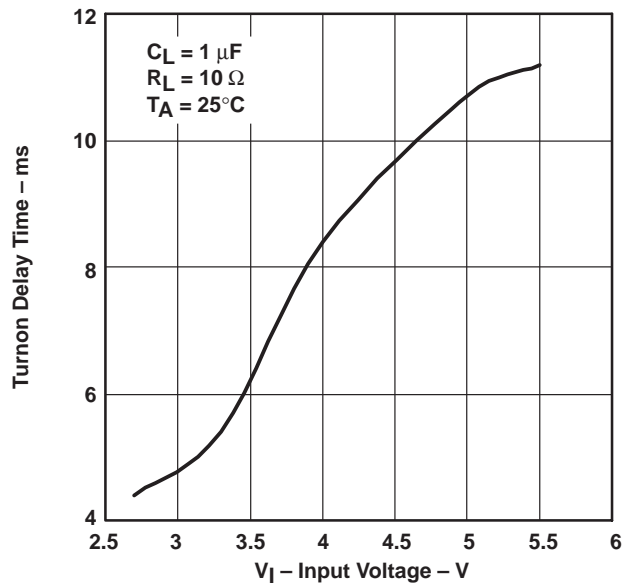

Figure 13

RISE TIME  
 vs  
 INPUT VOLTAGE

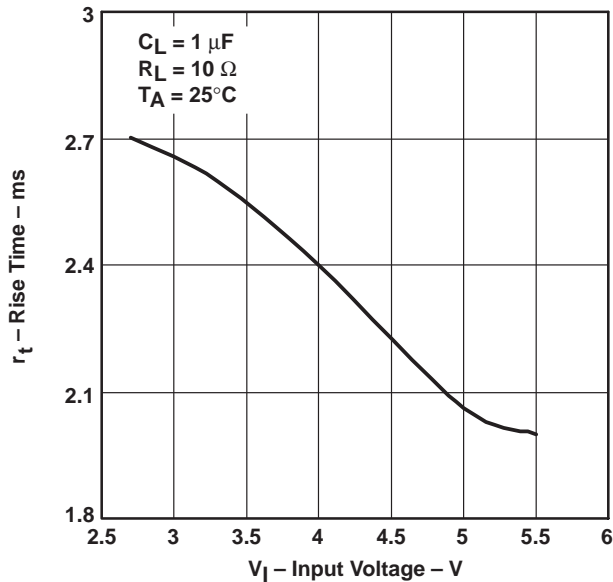

Figure 14

FALL TIME  
 vs  
 INPUT VOLTAGE

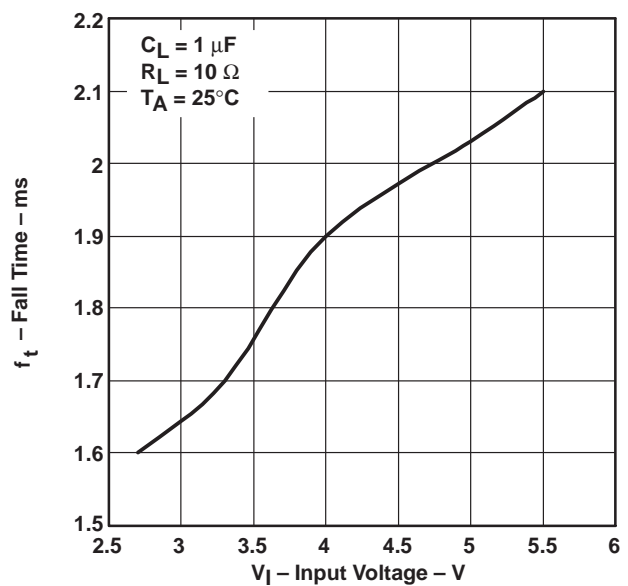

Figure 15

TYPICAL CHARACTERISTICS



Figure 16



Figure 17

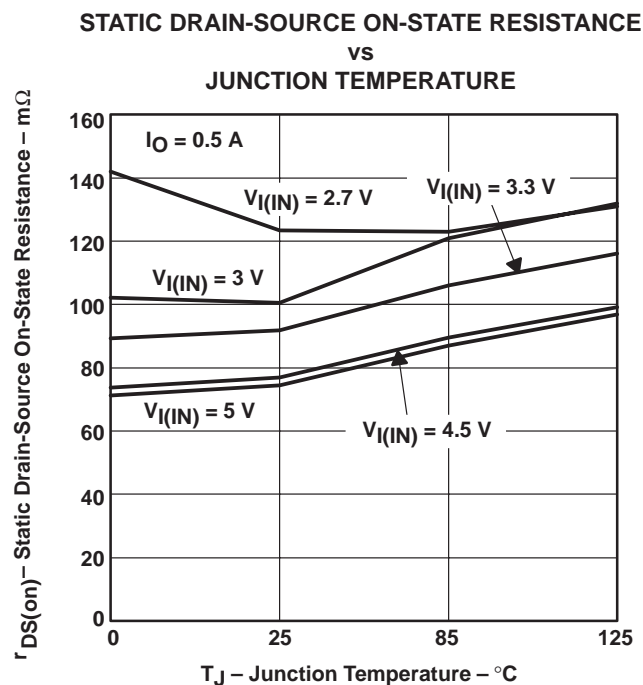

Figure 18

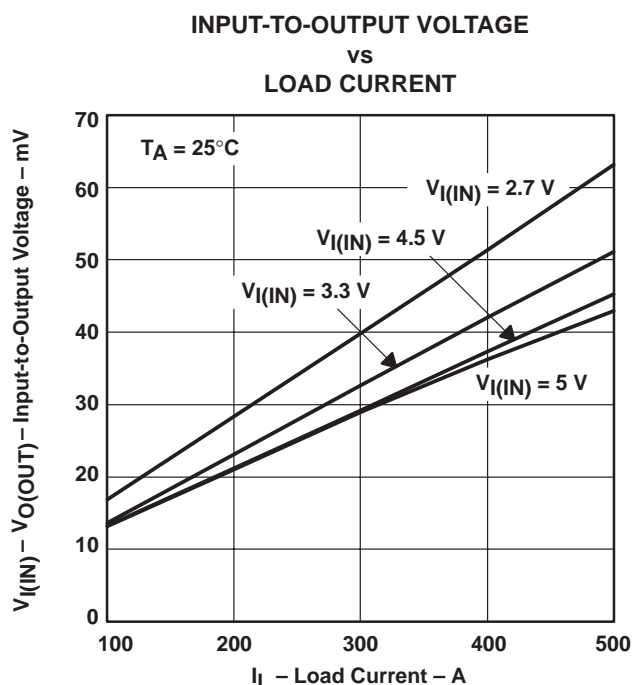

Figure 19

TYPICAL CHARACTERISTICS

SHORT-CIRCUIT OUTPUT CURRENT  
 VS  
 JUNCTION TEMPERATURE



Figure 20

THRESHOLD TRIP CURRENT  
 VS  
 INPUT VOLTAGE

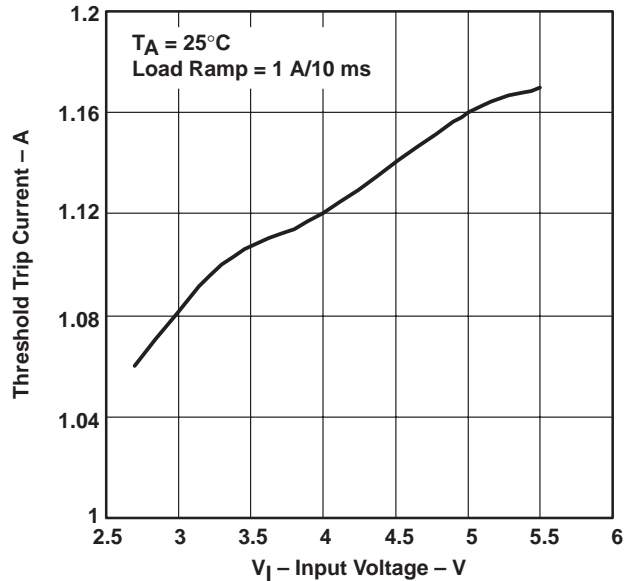

Figure 21

UNDERVOLTAGE LOCKOUT  
 VS  
 JUNCTION TEMPERATURE



Figure 22

CURRENT-LIMIT RESPONSE  
 VS  
 PEAK CURRENT

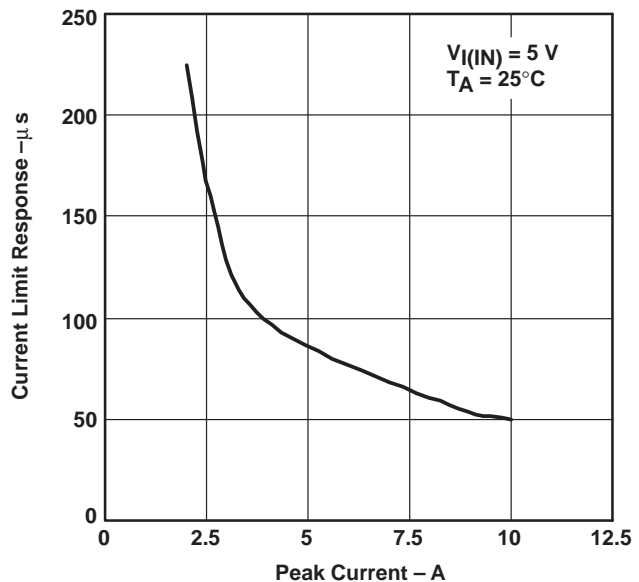

Figure 23

## APPLICATION INFORMATION



Figure 24. Typical Application (Example, TPS2041A)

### power-supply considerations

A 0.01- $\mu\text{F}$  to 0.1- $\mu\text{F}$  ceramic bypass capacitor between INx and GND, close to the device, is recommended. Placing a high-value electrolytic capacitor on the output pin(s) is recommended when the output load is heavy. This precaution reduces power-supply transients that may cause ringing on the input. Additionally, bypassing the output with a 0.01- $\mu\text{F}$  to 0.1- $\mu\text{F}$  ceramic capacitor improves the immunity of the device to short-circuit transients.

### overcurrent

A sense FET is employed to check for overcurrent conditions. Unlike current-sense resistors, sense FETs do not increase the series resistance of the current path. When an overcurrent condition is detected, the device maintains a constant output current and reduces the output voltage accordingly. Complete shutdown occurs only if the fault is present long enough to activate thermal limiting.

Three possible overload conditions can occur. In the first condition, the output has been shorted before the device is enabled or before  $V_{I(IN)}$  has been applied (see Figure 6). The TPS204xA and TPS205xA sense the short and immediately switch into a constant-current output.

In the second condition, a short or an overload occurs while the device is enabled. At the instant the overload occurs, very high currents may flow for a short time before the current-limit circuit can react. After the current-limit circuit has tripped (reached the overcurrent trip threshold) the device switches into constant-current mode.

In the third condition, the load has been gradually increased beyond the recommended operating current. The current is permitted to rise until the current-limit threshold is reached or until the thermal limit of the device is exceeded (see Figure 7). The TPS204xA and TPS205xA are capable of delivering current up to the current-limit threshold without damaging the device. Once the threshold has been reached, the device switches into its constant-current mode.

### $\overline{\text{OC}}$ response

The  $\overline{\text{OC}}$  open-drain output is asserted (active low) when an overcurrent or overtemperature condition is encountered. The output will remain asserted until the overcurrent or overtemperature condition is removed. Connecting a heavy capacitive load to an enabled device can cause momentary false overcurrent reporting from the inrush current flowing through the device, charging the downstream capacitor. The TPS204xA and TPS205xA family of devices are designed to reduce false overcurrent reporting. An internal overcurrent transient filter eliminates the need for external components to remove unwanted pulses. Using low-ESR electrolytic capacitors on the output lowers the inrush current flow through the device during hot-plug events by providing a low-impedance energy source, also reducing erroneous overcurrent reporting.

APPLICATION INFORMATION



Figure 25. Typical Circuit for  $\overline{OC}$  Pin (Example, TPS2041A)

power dissipation and junction temperature

The low on-resistance on the n-channel MOSFET allows small surface-mount packages, such as SOIC, to pass large currents. The thermal resistances of these packages are high compared to those of power packages; it is good design practice to check power dissipation and junction temperature. Begin by determining the  $r_{DS(on)}$  of the N-channel MOSFET relative to the input voltage and operating temperature. As an initial estimate, use the highest operating ambient temperature of interest and read  $r_{DS(on)}$  from Figure 18. Using this value, the power dissipation per switch can be calculated by:

$$P_D = r_{DS(on)} \times I^2$$

Depending on which device is being used, multiply this number by the number of switches being used. This step will render the total power dissipation from the N-channel MOSFETs.

Finally, calculate the junction temperature:

$$T_J = P_D \times R_{\theta JA} + T_A$$

Where:

$T_A$  = Ambient Temperature °C

$R_{\theta JA}$  = Thermal resistance SOIC = 172°C/W (for 8 pin), 111°C/W (for 16 pin)

$P_D$  = Total power dissipation based on number of switches being used.

Compare the calculated junction temperature with the initial estimate. If they do not agree within a few degrees, repeat the calculation, using the calculated value as the new estimate. Two or three iterations are generally sufficient to get a reasonable answer.

thermal protection

Thermal protection prevents damage to the IC when heavy-overload or short-circuit faults are present for extended periods of time. The faults force the TPS204xA and TPS205xA into constant-current mode, which causes the voltage across the high-side switch to increase; under short-circuit conditions, the voltage across the switch is equal to the input voltage. The increased dissipation causes the junction temperature to rise to high levels. The protection circuit senses the junction temperature of the switch and shuts it off. Hysteresis is built into the thermal sense circuit, and after the device has cooled approximately 20 degrees, the switch turns back on. The switch continues to cycle in this manner until the load fault or input power is removed.

The TPS204xA and TPS205xA implement a dual thermal trip to allow fully independent operation of the power distribution switches. In an overcurrent or short-circuit condition the junction temperature will rise. Once the die temperature rises to approximately 140°C, the internal thermal sense circuitry checks which power switch is in an overcurrent condition and turns that power switch off, thus isolating the fault without interrupting operation of the adjacent power switch. Should the die temperature exceed the first thermal trip point of 140°C and reach 160°C, both switches turn off. The  $\overline{OC}$  open-drain output is asserted (active low) when overtemperature or overcurrent occurs.

## APPLICATION INFORMATION

### undervoltage lockout (UVLO)

An undervoltage lockout ensures that the power switch is in the off state at power up. Whenever the input voltage falls below approximately 2 V, the power switch will be quickly turned off. This facilitates the design of hot-insertion systems where it is not possible to turn off the power switch before input power is removed. The UVLO will also keep the switch from being turned on until the power supply has reached at least 2 V, even if the switch is enabled. Upon reinsertion, the power switch will be turned on, with a controlled rise time to reduce EMI and voltage overshoots.

### universal serial bus (USB) applications

The universal serial bus (USB) interface is a 12-Mb/s, or 1.5-Mb/s, multiplexed serial bus designed for low-to-medium bandwidth PC peripherals (e.g., keyboards, printers, scanners, and mice). The four-wire USB interface is conceived for dynamic attach-detach (hot plug-unplug) of peripherals. Two lines are provided for differential data, and two lines are provided for 5-V power distribution.

USB data is a 3.3-V level signal, but power is distributed at 5 V to allow for voltage drops in cases where power is distributed through more than one hub across long cables. Each function must provide its own regulated 3.3 V from the 5-V input or its own internal power supply.

The USB specification defines the following five classes of devices, each differentiated by power-consumption requirements:

- Hosts/self-powered hubs (SPH)
- Bus-powered hubs (BPH)
- Low-power, bus-powered functions
- High-power, bus-powered functions
- Self-powered functions

Self-powered and bus-powered hubs distribute data and power to downstream functions. The TPS204xA and TPS205xA can provide power-distribution solutions for many of these classes of devices.

### host/self-powered and bus-powered hubs

Hosts and self-powered hubs have a local power supply that powers the embedded functions and the downstream ports (see Figures 26 and 27). This power supply must provide from 5.25 V to 4.75 V to the board side of the downstream connection under full-load and no-load conditions. Hosts and SPHs are required to have current-limit protection and must report overcurrent conditions to the USB controller. Typical SPHs are desktop PCs, monitors, printers, and stand-alone hubs.



Figure 26. Typical One-Port Solution

APPLICATION INFORMATION



Figure 27. Typical Four-Port USB Host/Self-Powered Hub

Bus-powered hubs obtain all power from upstream ports and often contain an embedded function. The hubs are required to power up with less than one unit load. The BPH usually has one embedded function, and power is always available to the controller of the hub. If the embedded function and hub require more than 100 mA on powerup, the power to the embedded function may need to be kept off until enumeration is completed. This can be accomplished by removing power or by shutting off the clock to the embedded function. Power switching the embedded function is not necessary if the aggregate power draw for the function and controller is less than one unit load. The total current drawn by the bus-powered device is the sum of the current to the controller, the embedded function, and the downstream ports, and it is limited to 500 mA from an upstream port.

## APPLICATION INFORMATION

### low-power bus-powered functions and high-power bus-powered functions

Both low-power and high-power bus-powered functions obtain all power from upstream ports; low-power functions always draw less than 100 mA; high-power functions must draw less than 100 mA at power up and can draw up to 500 mA after enumeration. If the load of the function is more than the parallel combination of 44  $\Omega$  and 10  $\mu\text{F}$  at power up, the device must implement inrush current limiting (see Figure 28).



Figure 28. High-Power Bus-Powered Function (Example, TPS2041A)

### USB power-distribution requirements

USB can be implemented in several ways, and, regardless of the type of USB device being developed, several power-distribution features must be implemented.

- Hosts/self-powered hubs must:
  - Current-limit downstream ports
  - Report overcurrent conditions on USB  $V_{\text{BUS}}$
- Bus-powered hubs must:
  - Enable/disable power to downstream ports
  - Power up at <100 mA
  - Limit inrush current (<44  $\Omega$  and 10  $\mu\text{F}$ )
- Functions must:
  - Limit inrush currents
  - Power up at <100 mA

The feature set of the TPS204xA and TPS205xA allows them to meet each of these requirements. The integrated current-limiting and overcurrent reporting is required by hosts and self-powered hubs. The logic-level enable and controlled rise times meet the need of both input and output ports on bus-power hubs, as well as the input ports for bus-power functions (see Figures 29 through 32).

TPS2041A, TPS2042A, TPS2043A, TPS2044A  
 TPS2051A, TPS2052A, TPS2053A, TPS2054A  
 CURRENT-LIMITED POWER-DISTRIBUTION SWITCHES

SLVS247 – SEPTEMBER 2000

APPLICATION INFORMATION



† USB rev 1.1 requires 120  $\mu$ F per hub.

Figure 29. Hybrid Self/Bus-Powered Hub Implementation, TPS2041A

APPLICATION INFORMATION



† USB rev 1.1 requires 120 µF per hub.

Figure 30. Hybrid Self/Bus-Powered Hub Implementation, TPS2042A

TPS2041A, TPS2042A, TPS2043A, TPS2044A  
 TPS2051A, TPS2052A, TPS2053A, TPS2054A  
 CURRENT-LIMITED POWER-DISTRIBUTION SWITCHES

SLVS247 – SEPTEMBER 2000

APPLICATION INFORMATION

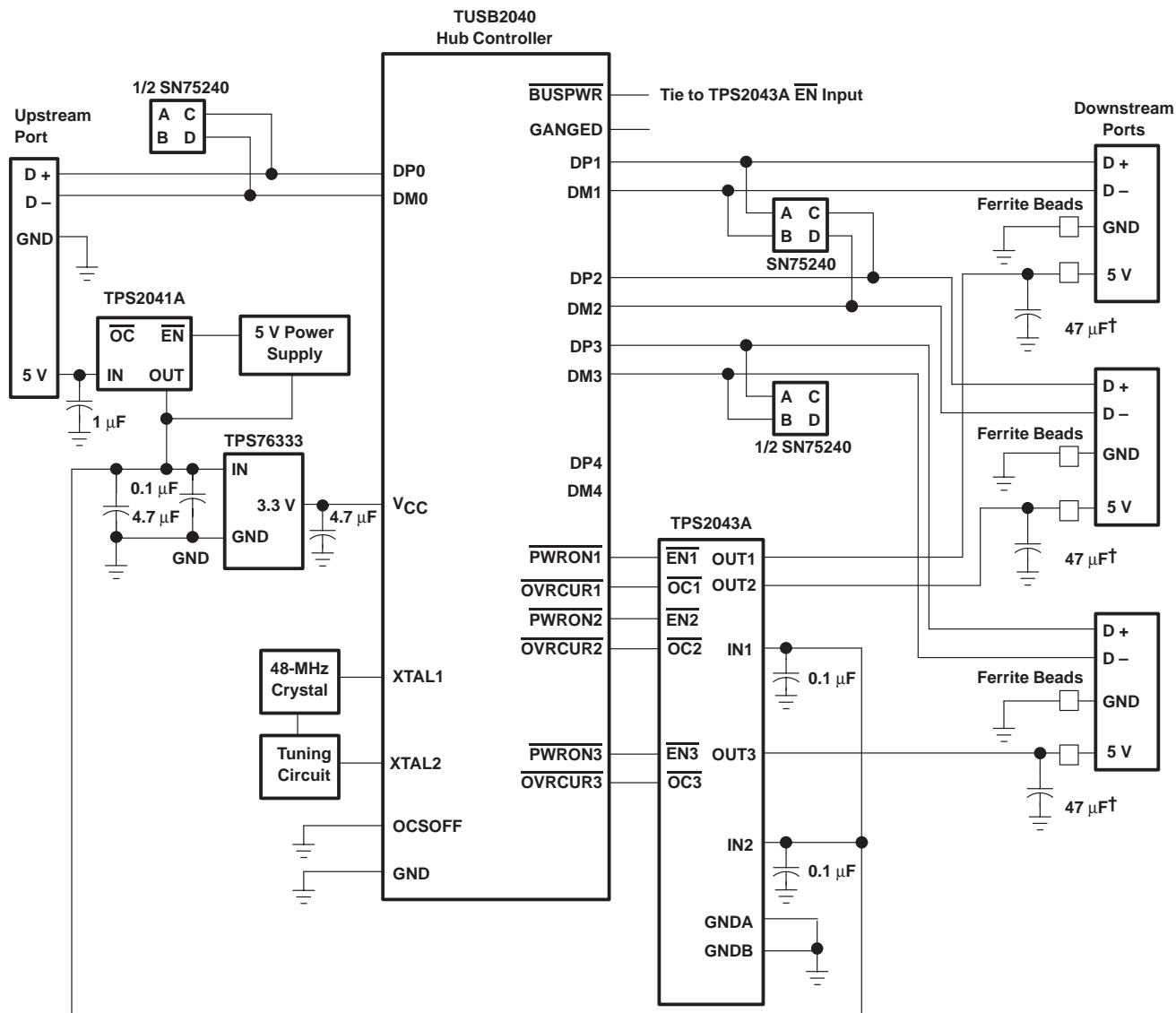

† USB rev 1.1 requires 120  $\mu$ F per hub.

Figure 31. Hybrid Self/Bus-Powered Hub Implementation, TPS2043A

APPLICATION INFORMATION



† USB rev 1.1 requires 120 µF per hub.

Figure 32. Hybrid Self/Bus-Powered Hub Implementation, TPS2044A

APPLICATION INFORMATION

generic hot-plug applications (see Figure 33)

In many applications it may be necessary to remove modules or pc boards while the main unit is still operating. These are considered hot-plug applications. Such implementations require the control of current surges seen by the main power supply and the card being inserted. The most effective way to control these surges is to limit and slowly ramp the current and voltage being applied to the card, similar to the way in which a power supply normally turns on. Due to the controlled rise times and fall times of the TPS204xA and TPS205xA, these devices can be used to provide a softer start-up to devices being hot-plugged into a powered system. The UVLO feature of the TPS204xA and TPS205xA also ensures the switch will be off after the card has been removed, and the switch will be off during the next insertion. The UVLO feature insures a soft start with a controlled rise time for every insertion of the card or module.



Figure 33. Typical Hot-Plug Implementation (Example, TPS2041A)

By placing the TPS204xA and TPS205xA between the  $V_{CC}$  input and the rest of the circuitry, the input power will reach these devices first after insertion. The typical rise time of the switch is approximately 2.5 ms, providing a slow voltage ramp at the output of the device. This implementation controls system surge currents and provides a hot-plugging mechanism for any device.

**PACKAGING INFORMATION**

Orderable Device	Status (1)	Package Type	Package Drawing	Pins	Package Qty	Eco Plan (2)	Lead finish/ Ball material (6)	MSL Peak Temp (3)	Op Temp (°C)	Device Marking (4/5)	Samples
TPS2041AD	ACTIVE	SOIC	D	8	75	RoHS & Green	NIPDAU	Level-1-260C-UNLIM	0 to 125	2041A	<a href="#">Samples</a>
TPS2041ADR	ACTIVE	SOIC	D	8	2500	RoHS & Green	NIPDAU	Level-1-260C-UNLIM	0 to 125	2041A	<a href="#">Samples</a>
TPS2041ADRG4	ACTIVE	SOIC	D	8	2500	RoHS & Green	NIPDAU	Level-1-260C-UNLIM	0 to 125	2041A	<a href="#">Samples</a>
TPS2042AD	ACTIVE	SOIC	D	8	75	RoHS & Green	NIPDAU	Level-1-260C-UNLIM	0 to 125	2042A	<a href="#">Samples</a>
TPS2042ADR	ACTIVE	SOIC	D	8	2500	RoHS & Green	NIPDAU	Level-1-260C-UNLIM	0 to 125	2042A	<a href="#">Samples</a>
TPS2043AD	ACTIVE	SOIC	D	16	40	RoHS & Green	NIPDAU	Level-1-260C-UNLIM	0 to 125	2043A	<a href="#">Samples</a>
TPS2044AD	ACTIVE	SOIC	D	16	40	RoHS & Green	NIPDAU	Level-1-260C-UNLIM	0 to 125	2044A	<a href="#">Samples</a>
TPS2044ADR	ACTIVE	SOIC	D	16	2500	RoHS & Green	NIPDAU	Level-1-260C-UNLIM	0 to 125	2044A	<a href="#">Samples</a>
TPS2051AD	ACTIVE	SOIC	D	8	75	RoHS & Green	NIPDAU	Level-1-260C-UNLIM	0 to 85	2051A	<a href="#">Samples</a>
TPS2051ADR	ACTIVE	SOIC	D	8	2500	RoHS & Green	NIPDAU	Level-1-260C-UNLIM	0 to 85	2051A	<a href="#">Samples</a>
TPS2052AD	ACTIVE	SOIC	D	8	75	RoHS & Green	NIPDAU	Level-1-260C-UNLIM	0 to 125	2052A	<a href="#">Samples</a>
TPS2052ADR	ACTIVE	SOIC	D	8	2500	RoHS & Green	NIPDAU	Level-1-260C-UNLIM	0 to 125	2052A	<a href="#">Samples</a>
TPS2054AD	ACTIVE	SOIC	D	16	40	RoHS & Green	NIPDAU	Level-1-260C-UNLIM	0 to 125	2054A	<a href="#">Samples</a>

(1) The marketing status values are defined as follows:

**ACTIVE:** Product device recommended for new designs.

**LIFEBUY:** TI has announced that the device will be discontinued, and a lifetime-buy period is in effect.

**NRND:** Not recommended for new designs. Device is in production to support existing customers, but TI does not recommend using this part in a new design.

**PREVIEW:** Device has been announced but is not in production. Samples may or may not be available.

**OBSELETE:** TI has discontinued the production of the device.

(2) **RoHS:** TI defines "RoHS" to mean semiconductor products that are compliant with the current EU RoHS requirements for all 10 RoHS substances, including the requirement that RoHS substance do not exceed 0.1% by weight in homogeneous materials. Where designed to be soldered at high temperatures, "RoHS" products are suitable for use in specified lead-free processes. TI may reference these types of products as "Pb-Free".

**RoHS Exempt:** TI defines "RoHS Exempt" to mean products that contain lead but are compliant with EU RoHS pursuant to a specific EU RoHS exemption.

**Green:** TI defines "Green" to mean the content of Chlorine (Cl) and Bromine (Br) based flame retardants meet JS709B low halogen requirements of <=1000ppm threshold. Antimony trioxide based flame retardants must also meet the <=1000ppm threshold requirement.

- (3) MSL, Peak Temp. - The Moisture Sensitivity Level rating according to the JEDEC industry standard classifications, and peak solder temperature.
- (4) There may be additional marking, which relates to the logo, the lot trace code information, or the environmental category on the device.
- (5) Multiple Device Markings will be inside parentheses. Only one Device Marking contained in parentheses and separated by a "~" will appear on a device. If a line is indented then it is a continuation of the previous line and the two combined represent the entire Device Marking for that device.
- (6) Lead finish/Ball material - Orderable Devices may have multiple material finish options. Finish options are separated by a vertical ruled line. Lead finish/Ball material values may wrap to two lines if the finish value exceeds the maximum column width.

**Important Information and Disclaimer:**The information provided on this page represents TI's knowledge and belief as of the date that it is provided. TI bases its knowledge and belief on information provided by third parties, and makes no representation or warranty as to the accuracy of such information. Efforts are underway to better integrate information from third parties. TI has taken and continues to take reasonable steps to provide representative and accurate information but may not have conducted destructive testing or chemical analysis on incoming materials and chemicals. TI and TI suppliers consider certain information to be proprietary, and thus CAS numbers and other limited information may not be available for release.

In no event shall TI's liability arising out of such information exceed the total purchase price of the TI part(s) at issue in this document sold by TI to Customer on an annual basis.

**TAPE AND REEL INFORMATION**

**QUADRANT ASSIGNMENTS FOR PIN 1 ORIENTATION IN TAPE**

\*All dimensions are nominal

Device	Package Type	Package Drawing	Pins	SPQ	Reel Diameter (mm)	Reel Width W1 (mm)	A0 (mm)	B0 (mm)	K0 (mm)	P1 (mm)	W (mm)	Pin1 Quadrant
TPS2041ADR	SOIC	D	8	2500	330.0	12.4	6.4	5.2	2.1	8.0	12.0	Q1
TPS2042ADR	SOIC	D	8	2500	330.0	12.4	6.4	5.2	2.1	8.0	12.0	Q1
TPS2044ADR	SOIC	D	16	2500	330.0	16.4	6.5	10.3	2.1	8.0	16.0	Q1
TPS2051ADR	SOIC	D	8	2500	330.0	12.4	6.4	5.2	2.1	8.0	12.0	Q1
TPS2052ADR	SOIC	D	8	2500	330.0	12.4	6.4	5.2	2.1	8.0	12.0	Q1

**TAPE AND REEL BOX DIMENSIONS**

\*All dimensions are nominal

Device	Package Type	Package Drawing	Pins	SPQ	Length (mm)	Width (mm)	Height (mm)
TPS2041ADR	SOIC	D	8	2500	340.5	338.1	20.6
TPS2042ADR	SOIC	D	8	2500	340.5	338.1	20.6
TPS2044ADR	SOIC	D	16	2500	340.5	336.1	32.0
TPS2051ADR	SOIC	D	8	2500	340.5	338.1	20.6
TPS2052ADR	SOIC	D	8	2500	340.5	338.1	20.6

**TUBE**

\*All dimensions are nominal

Device	Package Name	Package Type	Pins	SPQ	L (mm)	W (mm)	T (μm)	B (mm)
TPS2041AD	D	SOIC	8	75	507	8	3940	4.32
TPS2042AD	D	SOIC	8	75	507	8	3940	4.32
TPS2043AD	D	SOIC	16	40	507	8	3940	4.32
TPS2044AD	D	SOIC	16	40	507	8	3940	4.32
TPS2051AD	D	SOIC	8	75	507	8	3940	4.32
TPS2052AD	D	SOIC	8	75	507	8	3940	4.32
TPS2054AD	D	SOIC	16	40	507	8	3940	4.32

## IMPORTANT NOTICE AND DISCLAIMER

TI PROVIDES TECHNICAL AND RELIABILITY DATA (INCLUDING DATA SHEETS), DESIGN RESOURCES (INCLUDING REFERENCE DESIGNS), APPLICATION OR OTHER DESIGN ADVICE, WEB TOOLS, SAFETY INFORMATION, AND OTHER RESOURCES "AS IS" AND WITH ALL FAULTS, AND DISCLAIMS ALL WARRANTIES, EXPRESS AND IMPLIED, INCLUDING WITHOUT LIMITATION ANY IMPLIED WARRANTIES OF MERCHANTABILITY, FITNESS FOR A PARTICULAR PURPOSE OR NON-INFRINGEMENT OF THIRD PARTY INTELLECTUAL PROPERTY RIGHTS.

These resources are intended for skilled developers designing with TI products. You are solely responsible for (1) selecting the appropriate TI products for your application, (2) designing, validating and testing your application, and (3) ensuring your application meets applicable standards, and any other safety, security, regulatory or other requirements.

These resources are subject to change without notice. TI grants you permission to use these resources only for development of an application that uses the TI products described in the resource. Other reproduction and display of these resources is prohibited. No license is granted to any other TI intellectual property right or to any third party intellectual property right. TI disclaims responsibility for, and you will fully indemnify TI and its representatives against, any claims, damages, costs, losses, and liabilities arising out of your use of these resources.

TI's products are provided subject to [TI's Terms of Sale](#) or other applicable terms available either on [ti.com](https://www.ti.com) or provided in conjunction with such TI products. TI's provision of these resources does not expand or otherwise alter TI's applicable warranties or warranty disclaimers for TI products.

TI objects to and rejects any additional or different terms you may have proposed.

Mailing Address: Texas Instruments, Post Office Box 655303, Dallas, Texas 75265  
Copyright © 2023, Texas Instruments Incorporated

## Looking for pricing, stock, or lifecycle information?

Click below to explore more details on WIN SOURCE:

 [View TPS2051ADR](#) on WIN SOURCE

 [Texas Instruments](#) Information

## Optimize Your Supply Chain with WIN SOURCE Solutions

-  Global Sourcing Solution
-  Obsolete Management
-  Cost Control Management
-  Shortage Management
-  Alternative Solution
-  Excess Inventory Management