

**PRODUCT GUIDE**

**MOSFETs**



Toshiba's MOSFET devices meet the needs of a wide range of ultra-high-density applications.

# POWER-MOSFETS CONTENTS

|   |           |
|---|-----------|
| <b>1 Features and Structures</b> .....  | <b>3</b>  |
| <b>2 Toshiba's MOSFET Product Lines and Part Numbering Schemes</b> .....                              | <b>4</b>  |
| 2-1 MOSFET Product Lines .....  | 4         |
| 2-2 Part Numbering Schemes .....  | 5         |
| <b>3 Selection Guide (By Absolute Maximum Ratings)</b> .....  | <b>6</b>  |
| <b>4 Low-V<sub>DSS</sub> MOSFETs (in Small SMD Packages)</b> .....                                    | <b>16</b> |
| 4-1 Packaging Options .....   | 16        |
| • SSM Series  |           |
| • TPC Series  |           |
| 4-2 Application Examples and Block Diagrams .....   | 17        |
| • Cell Phone (Power Supply Circuit)   |           |
| • Notebook PC (Power Supply Circuit)  |           |
| • Lithium-Ion Secondary Battery (Battery Protection Circuits)   |           |
| • Motor Driver (Power Driver Circuit)   |           |
| 4-3 Low-V <sub>DSS</sub> MOSFET Roadmaps .....  | 19        |
| • Roadmap for Trench MOSFETs  |           |
| • Package Options   |           |
| 4-4 Low-V <sub>DSS</sub> , High-Speed MOSFETs .....   | 21        |
| • Synchronous Rectification DC-DC Converters  |           |
| – Block Diagram, Timing Chart and Power Loss Factors  |           |
| – Summary Results of Power Loss Simulation and Key Parameters for MOSFETs                             |           |
| – Efficiency Improvement by Thermally Enhanced Package and New Process Technology                     |           |
| – MOSBD (MOSFET with SBD)   |           |
| • High-Speed MOSFET Offerings   |           |
| 4-5 Low-V <sub>DSS</sub> , Low-R <sub>DS(ON)</sub> MOSFETs (for Lithium-Ion Battery Protection) ..... | 26        |
| • Lithium-Ion Battery Protection Circuit Trend  |           |
| • MOSFET Roadmap  |           |
| • Low-ON-resistance N-Channel Power MOSFETs   |           |
| • Low-ON-resistance P-Channel Power MOSFETs   |           |
| 4-6 Semi-Power MOSFET Offerings .....   | 28        |
| • Semi-Power P-Channel Single MOSFETs   |           |
| • Semi-Power N-Channel Single MOSFETs   |           |
| • Semi-Power Dual MOSFETs   |           |
| • MOSFET with a Schottky Barrier Diode  |           |
| • VS-6 Series ... [Part Number: TPC6xxx]  |           |
| • VS-8 Series ... [Part Number: TPCF8xxx]   |           |
| • PS-8 Series ... [Part Number: TPCP8xxx]   |           |
| • Chip LGA Series ... [Part Number: TPCL4xxx]   |           |
| • STP2 Series ... [Part Number: TPCT4xxx]   |           |
| • TSON Advance Series ... [Part Number: TPCC8xxx]   |           |
| • TSSOP Advance Series ... [Part Number: TPCM8xxx]  |           |
| • SOP-8 Series ... [Part Number: TPC8xxx]   |           |
| • SOP Advance Series ... [Part Number: TPCA8xxx]  |           |
| • DPAK Series ... [Part Number: TKxxPxxM1]  |           |
| 4-7 Standard MOSFET Series (I <sub>D</sub> < 500 mA) .....  | 36        |
| • Single MOSFETs  |           |
| • Dual MOSFETs  |           |
| <b>5 Low-V<sub>DSS</sub>, High-Q<sub>g</sub> MOSFETs</b> .....  | <b>37</b> |
| 5-1 TO-220SM(W) Series .....  | 37        |
| 5-2 U-MOS (Trench Type) Series .....  | 38        |
| 5-3 U-MOS Series for Synchronous Rectification (V <sub>DSS</sub> = 60 V to 150 V) .....               | 39        |
| <b>6 Mid- and High-V<sub>DSS</sub> MOSFETs</b> .....  | <b>40</b> |
| 6-1 $\pi$ -MOSVII Series (V <sub>DSS</sub> = 450 V to 650 V) .....                                    | 40        |
| 6-2 Super-Junction DTMOS Series (V <sub>DSS</sub> = 600 V, 650 V) .....                               | 41        |
| 6-3 High-speed $\pi$ -MOS Series (V <sub>DSS</sub> = 450 V to 600 V) .....                            | 42        |
| 6-4 $\pi$ -MOS Series .....   | 43        |
| <b>7 MOSFET Part Numbers</b> .....  | <b>46</b> |
| 7-1 Alphanumeric Index of Part Numbers .....  | 46        |
| <b>8 Product Obsolescence</b> .....   | <b>53</b> |
| 8-1 End-of-Life Products .....  | 53        |
| <b>9 Packaging</b> .....  | <b>55</b> |
| 9-1 Compact Surface-Mount Packages .....  | 55        |
| 9-2 Through-Hole Packages .....   | 66        |

- 1) No carrier storage effect; superior frequency and switching characteristics
- 2) Rugged and no current concentration
- 3) Voltage-controlled device, hence low drive power
- 4) Easy parallel connection

■ Toshiba MOSFETs have the following additional features:

- 1) Guaranteed avalanche capability..... Allows an absorber circuit to be simplified
- 2) Improved functioning of built-in diodes ..... Enhanced circuit design flexibility
- 3) High ruggedness ..... Increased margin for circuit design
- 4) High-speed switching ..... Higher speed in end-product's operation
- 5) Low  $R_{(DS)ON}$  ..... Reduced end-product's power consumption
- 6) Smaller packages ..... Reduced end-product size
- 7) Low drive loss ..... Reduced end product's power

■ Structures of Toshiba MOSFETs

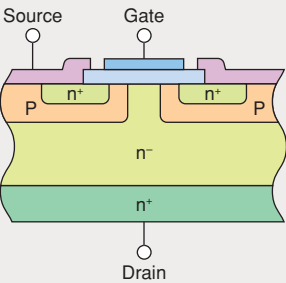
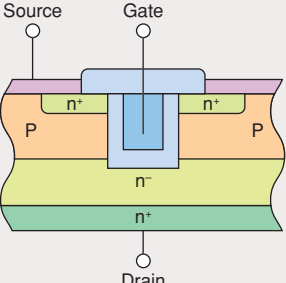
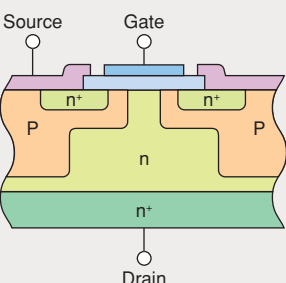
|  |  |
|--|--|
| <p>Double-Diffusion Structure</p>  | <p>● <math>\pi</math>-MOS</p> <p>Toshiba Power MOSFETs use a double-diffusion MOS (D-MOS) structure, which produces high-withstand voltage, to form channels. This structure is especially well suited to high-withstand voltage and high-current devices. A high level of integration yields a high-performance Power MOSFET with low ON-resistance and low power loss.</p> |
| <p>Trench Structure</p>           | <p>● U-MOS</p> <p>Higher channel density is achieved by connecting channels vertically to form a U-groove at the gate region, a structure that yields a lower ON-resistance than other MOSFET structures.</p>  |
| <p>Super-Junction Structure</p>   | <p>● DTMOS</p> <p>The super-junction structure, which has P-type pillar layers as shown left, realizes high withstand voltage and ON-resistance lower than the conventional theoretical limit of silicon.</p>  |

## 2-1 MOSFET Product Lines

### SSM Series ( $V_{DSS} = 12\text{ V to }60\text{ V}$ )

Very compact and thin, the SSM Series is suitable for use in various electronic devices. The SSM Series is available in a wide range of packages and features low voltage drive.

- Applications
- Cell phones ● Notebook PCs
- Portable electronic devices ● Small-signal switching

### VS and PS Series ( $V_{DSS} = 12\text{ V to }40\text{ V}$ )

Very compact and thin, the VS and PS Series are suitable for use in various electronic devices.

- Applications
- Cell phones ● Notebook PCs
- Portable electronic devices

### Chip LGA and STP Series ( $V_{DSS} = 20\text{ V to }30\text{ V}$ )

The LGA and STP Series are housed in an ultra-small and thin package and are suitable for use in lithium-ion secondary battery protection circuits in various portable electronic devices.

- Applications
- Lithium-ion secondary battery protection circuits

### SOP and TSON Series ( $V_{DSS} = 20\text{ V to }250\text{ V}$ )

The SOP and TSON Series are compact and thin, and require only a small mounting area. They are suitable for lithium-ion secondary battery protection circuits and notebook PCs.

- Applications
- Lithium-ion secondary battery protection circuits
- Notebook PCs ● Portable electronic devices
- DC-DC converters

### TO-220SM(W) Series ( $V_{DSS} = 40\text{ V to }150\text{ V}$ )

The TO-220SM package, which uses Cu connectors and a wide source terminal, realizes low ON-resistance and a high current-carrying capability.

- Applications
- Motor drivers ● Switching power supplies

### Low- $V_{DSS}$ , High- $Q_g$ U-MOS Series ( $V_{DSS} = 40\text{ V to }100\text{ V}$ )

High integration is achieved using a trench technology. Low-voltage drive ( $V_{GS} = 4\text{ V}$ ) is possible due to ultra-low ON-resistance.

- Applications
- Motor drivers ● Solenoids and lamp drivers

### U-MOS Series for Synchronous Rectification ( $V_{DSS} = 60\text{ V to }150\text{ V}$ )

Fabricated using a trench technology, the U-MOS Series is ideal for synchronous rectification on the secondary side of power supply circuits.

- Applications
- Switching power supplies ● AC adapters
- Motor drivers

### New $\pi$ -MOSVII Series ( $V_{DSS} = 450\text{ V to }650\text{ V}$ )

The latest addition to the  $\pi$ -MOS portfolio, the  $\pi$ -MOSVII Series offers reduced capacitances due to optimized chip design and is available with a greatly wider range of electrical characteristics.

- Applications
- Switching power supplies ● AC adapters

### Super-Junction DTMOS Series ( $V_{DSS} = 600, 650\text{ V}$ )

The super-junction DTMOS Series achieves low ON-resistance and low gate charge ( $Q_g$ ) due to the use of the latest super-junction structure.

- Applications
- Switching power supplies ● AC adapters
- Motor drivers

### High-Speed $\pi$ -MOS Series ( $V_{DSS} = 450\text{ V to }600\text{ V}$ )

The new High-Speed  $\pi$ -MOS Series achieves higher switching speed than the well-proven  $\pi$ -MOS Series. Two series are available: high-speed switching series and high-speed diode series.

- Applications
- Inverters ● Switching power supplies
- Motor drivers ● AC adapters

## 2-2 Part Numbering Schemes

### Small-Signal MOSFET (SSM) Series

**SSM 3 K 101 TU**

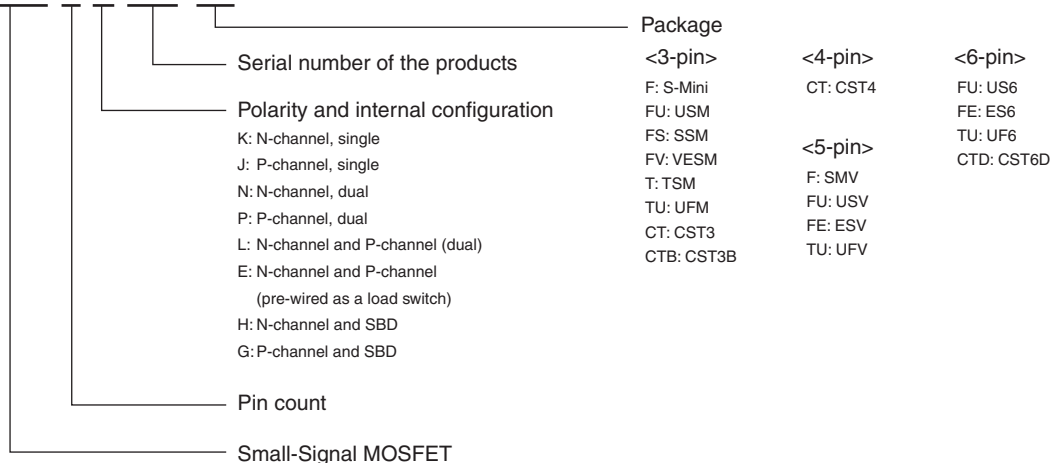

### Multi-Pin Series

**TPCM8 0 01 -H**

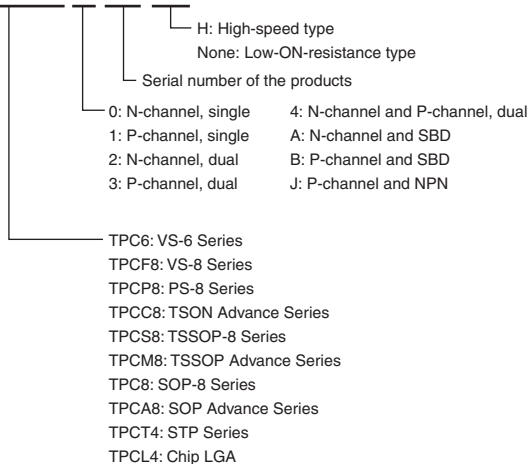

### New Series

**TK 55 A 10 J 1**

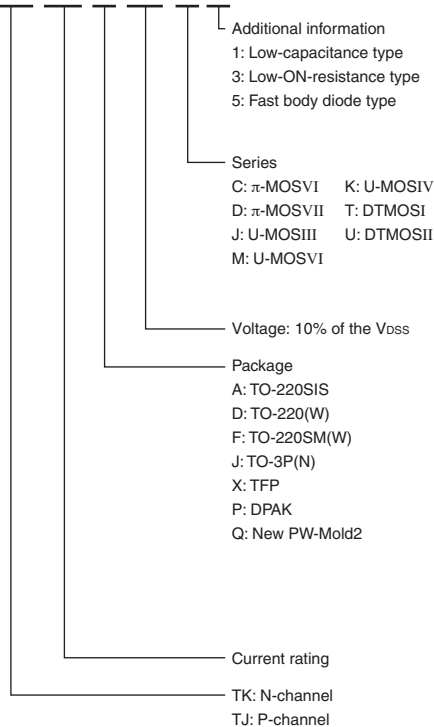

### Conventional Series

**2SK\*\*\*\***

N-channel MOS

**2SJ\*\*\*\***

P-channel MOS

| V <sub>DS</sub> (V)<br>I <sub>D</sub> (A) | 12 | 20   | 24 | 30   | 40 | 50  | 60   | 100 | 150 | 180 | 200 | 250 | 400 | 450 | 500 | 525 | 550 | 600 | 650 | V <sub>DS</sub> (V)<br>I <sub>D</sub> (A) |      |
|---|----|--|----|--|----|---|--|-----|-----|-----|-----|-----|-----|-----|-----|-----|-----|-----|-----|---|------|
| 0.05                                      |    |  |    |  |    | *2SJ343(50) <sup>①</sup><br>*2SJ344(50) <sup>①</sup>  |  |     |     |     |     |     |     |     |     |     |     |     |     | 0.05                                      |      |
| 0.1                                       |    | *SSM3K04FU(12) <sup>②</sup><br>*SSM3K16FU(15) <sup>③</sup><br>*SSM3J16FU(45) <sup>④</sup><br>*SSM3K04FS(12) <sup>⑤</sup><br>*SSM3K16FS(15) <sup>⑥</sup><br>*SSM3J16FS(45) <sup>⑦</sup><br>*SSM3J35FS(44) <sup>⑧</sup><br>*SSM3K03FV(12) <sup>⑨</sup><br>*SSM3K04FV(12) <sup>⑩</sup><br>*SSM3K16FV(15) <sup>⑪</sup><br>*SSM3J16FV(45) <sup>⑫</sup><br>*SSM3J35MFV(44) <sup>⑬</sup><br>*SSM3K16CT(15) <sup>⑭</sup><br>*SSM3J16CT(45) <sup>⑮</sup><br>*SSM3J35CT(44) <sup>⑯</sup><br>*SSM6N04FU(12) <sup>⑰</sup><br>*SSM6N16FU(15) <sup>⑱</sup><br>*SSM6P16FU(45) <sup>⑲</sup><br>*SSM6P35FU(44) <sup>⑳</sup><br>*SSM6N03FE(12) <sup>㉑</sup><br>*SSM6N16FE(15) <sup>㉒</sup><br>*SSM6P16FE(45) <sup>㉓</sup><br>*SSM6L16FE(15) <sup>㉔</sup><br>*SSM6P35FE(45) <sup>㉕</sup><br>*SSM5N16FU(15) <sup>㉖</sup><br>*SSM5P16FU(45) <sup>㉗</sup><br>*SSM5N03FE(12) <sup>㉘</sup><br>*SSM5N16FE(15) <sup>㉙</sup><br>*SSM5P16FE(45) <sup>㉚</sup> |    | *SSM3K15F(7) <sup>①</sup><br>*SSM3J15F(32) <sup>②</sup><br>*SSM3K15FU(7) <sup>③</sup><br>*SSM3J15FU(32) <sup>④</sup><br>*SSM3K15FS(7) <sup>⑤</sup><br>*SSM3J15FS(32) <sup>⑥</sup><br>*SSM3K15FV(7) <sup>⑦</sup><br>*SSM3J15FV(32) <sup>⑧</sup><br>*SSM3K15CT(7) <sup>⑨</sup><br>*SSM3J15CT(32) <sup>⑩</sup><br>*SSM6N15FU(7) <sup>⑪</sup><br>*SSM6P15FU(32) <sup>⑫</sup><br>*SSM5N15FU(7) <sup>⑬</sup><br>*SSM5P15FU(32) <sup>⑭</sup><br>*SSM6N15FE(7) <sup>⑮</sup><br>*SSM6P15FE(32) <sup>⑯</sup><br>*SSM5N15FE(7) <sup>⑰</sup><br>*SSM5P15FE(32) <sup>⑱</sup><br>*SSM3K44FV(7) <sup>⑲</sup><br>*SSM3K44MFV(7) <sup>⑳</sup><br>*SSM6N44FU(7) <sup>㉑</sup><br>*SSM6N44FE(7) <sup>㉒</sup> |    |   | *SSM3K17FU(40) <sup>①</sup><br>*SSM6N17FU(40) <sup>②</sup> |     |     |     |     |     |     |     |     |     |     |     |     |   | 0.1  |
| 0.18                                      |    | *SSM3K35FS(20) <sup>①</sup><br>*SSM3K35MFV(20) <sup>②</sup><br>*SSM3K35CT(20) <sup>③</sup><br>*SSM6N35FU(20) <sup>④</sup><br>*SSM6L35FU(20) <sup>⑤</sup><br>*SSM6N35FE(20) <sup>⑥</sup><br>*SSM6L35FE(20) <sup>⑦</sup>   |    |  |    |   |  |     |     |     |     |     |     |     |     |     |     |     |     |   | 0.18 |
| 0.2                                       |    | *SSM3J05FU(4) <sup>①</sup><br>*SSM6P05FU(4) <sup>②</sup><br>*SSM5P05FU(4) <sup>③</sup>   |    | *2SJ305(4) <sup>①</sup><br>*2SK2009(2) <sup>②</sup><br>*SSM3J09FU(4.2) <sup>③</sup><br>*SSM6P09FU(4.2) <sup>④</sup>  |    | *SSM3K7002BF(3.3) <sup>①</sup> *SSM6N7002BFU(3.3) <sup>②</sup><br>*SSM3K7002BFS(3.3) <sup>③</sup> *SSM6N7002BFS(3.3) <sup>④</sup><br>*SSM3K7002F(3.3) <sup>⑤</sup> *SSM6N7002AFU(3.3) <sup>⑥</sup><br>*SSM3K7002AF(3.3) <sup>⑦</sup> *2SJ168(2) <sup>⑧</sup><br>*SSM3K7002FU(3.3) <sup>⑨</sup> *2SK1062(1) <sup>⑩</sup><br>*SSM3K7002AFU(3.3) <sup>⑪</sup><br>*SSM6N7002BFE(3.3) <sup>⑫</sup> |  |     |     |     |     |     |     |     |     |     |     |     |     |   | 0.2  |
| 0.25                                      |    | *SSM6N37CTD(5.6) <sup>①</sup>  |    |  |    |   |  |     |     |     |     |     |     |     |     |     |     |     |     |   | 0.25 |
| 0.33                                      |    | *SSM3J36TU(3.6) <sup>①</sup><br>*SSM3J36FS(3.6) <sup>②</sup><br>*SSM3J36MFV(3.6) <sup>③</sup><br>*SSM6P36TU(3.6) <sup>④</sup><br>*SSM6P36FE(3.6) <sup>⑤</sup>  |    |  |    |   |  |     |     |     |     |     |     |     |     |     |     |     |     |   | 0.33 |
| 0.4                                       |    | *SSM6L05FU(1.2) <sup>①</sup><br>*SSM6N05FU(1.2) <sup>②</sup><br>*SSM3K05FU(1.2) <sup>③</sup><br>*SSM5N05FU(1.2) <sup>④</sup>   |    | *SSM6L09FU(1.2) <sup>①</sup><br>*SSM6N09FU(1.2) <sup>②</sup><br>*SSM3K09FU(1.2) <sup>③</sup>   |    |   |  |     |     |     |     |     |     |     |     |     |     |     |     |   | 0.4  |
| 0.5                                       |    | *SSM4K27CT(0.205) <sup>①</sup><br>*SSM6L10TU(0.145) <sup>②</sup><br>*SSM6L11TU(0.145) <sup>③</sup><br>*SSM6L12TU(0.145) <sup>④</sup><br>*SSM6N25TU(0.145) <sup>⑤</sup><br>*SSM6N36TU(1.52) <sup>⑥</sup><br>*SSM6P25TU(0.26) <sup>⑦</sup><br>*SSM6P26TU(0.23) <sup>⑧</sup><br>*SSM6J25FE(0.26) <sup>⑨</sup><br>*SSM6J26FE(0.23) <sup>⑩</sup><br>*SSM6K25FE(0.145) <sup>⑪</sup><br>*SSM6L36TU(1.52) <sup>⑫</sup><br>*SSM3K36FS(1.52) <sup>⑬</sup><br>*SSM3K36MFV(1.52) <sup>⑭</sup><br>*SSM3K36TU(1.52) <sup>⑮</sup><br>*SSM6N36FE(1.52) <sup>⑯</sup><br>*SSM6L36FE(1.52) <sup>⑰</sup><br>*SSM6N43FU(1.52) <sup>⑱</sup><br>*SSM3K43FS(1.52) <sup>⑲</sup>   |    | *SSM6N24TU(0.145) <sup>①</sup><br>*SSM6K24FE(0.145) <sup>②</sup>   |    |   |  |     |     |     |     |     |     |     |     |     |     |     |     |   | 0.5  |
| 0.65                                      |    | *SSM6J06FU(0.5) <sup>①</sup>   |    |  |    |   |  |     |     |     |     |     |     |     |     |     |     |     |     |   | 0.65 |
| 0.72                                      |    | *SSM6P41FE(0.3) <sup>①</sup>   |    |  |    |   |  |     |     |     |     |     |     |     |     |     |     |     |     |   | 0.72 |
| 0.77                                      |    | *SSM6N42FE(0.26) <sup>①</sup>  |    |  |    |   |  |     |     |     |     |     |     |     |     |     |     |     |     |   | 0.77 |
| 0.8                                       |    | *SSM6L13TU(0.143) <sup>①</sup><br>*SSM6N29TU(0.143) <sup>②</sup><br>*SSM6P28TU(0.234) <sup>③</sup><br>*SSM6J205FE(0.234) <sup>④</sup>  |    | *SSM6J07FU(0.8) <sup>①</sup>   |    |   |  |     |     |     |     |     |     |     |     |     |     |     |     |   | 0.8  |

Legend **Product series** ①: π-MOSIII ②: π-MOSV ③: π-MOSVI ④: L<sup>2</sup>-π-MOSV ⑤: L<sup>2</sup>-π-MOSVI ⑥: U-MOS ⑦: π-MOSVII ⑧: π-MOSIV ⑨: DTMOI ⑩: DTMOII

**Package** ◊PW-Mini ◊VS-8 ♥VS-6 ♣PS-8 ◊STP ▲TO-92MOD ▼PW-Mold J New PW-Mold ⊙TSON Advance ◊New PW-Mold2 ▽DP ☆TPS ◊TSSOP Advance ✕TSSOP-8 ★SOP-8 ◊SOP-8 Lead Clamp ▶SOP Advance ◆TO-220NIS ⊗TO-220SIS ■TO-220AB ◻TO-220(W) ♣TFP ○TO-220FL/SM ◊TO-220SM(W) ◻TO-3P(N) ◉TO-3P(N)IS ●TO-3P(L) ◻Chip LGA \*S-Mini +TSM \*USM △UFM ☆SSM +VESM +CST3 ◊CST3B ◊CST4 +SMV △US6 \*UF6 +ES6 \*CST6D △USV \*UFV ☆ESV

Notes: ( ) = R<sub>DS(on)</sub> max ( ) = High-speed diode # = 2.5-V drive \* = 1.8-V drive P = P-ch CN = Complementary N-ch CP = Complementary P-ch NS = N-ch + SBD PD = P-ch + Driver (load switch) PS = P-ch + SBD [ ] = Under development

| V <sub>DS</sub> (V)<br>I <sub>o</sub> (A) | 12  | 20  | 24 | 30  | 40                    | 50                     | 60                                | 100  | 150                    | 180  | 200                | 250                                   | 400                                | 450   | 500                                  | 525                                | 550 | 600 | 800   | 900   | 1000  | V <sub>DS</sub> (V)<br>I <sub>o</sub> (A) |     |
|---|---|---|----|---|-----------------------|------------------------|-----------------------------------|--|------------------------|--|--------------------|---------------------------------------|------------------------------------|---|--------------------------------------|------------------------------------|-----|-----|---|---|---|---|-----|
| 1   | PS *SSM5G02TU (0.16)Ⓢ<br>PS *SSM5G04TU (0.24)Ⓢ<br>PD *SSM6E01TU (0.16)Ⓢ | △SSM3J111TU (0.48)Ⓢ   |    | PS *SSM5G01TU (0.8)Ⓢ  |                       |                        | ◇2SJ360 (0.73)Ⓢ<br>▲2SJ507 (0.7)Ⓢ | ◇2SK2963 (0.7)Ⓢ<br>▲2SK2962 (0.7)Ⓢ<br>◇2SJ508 (1.9)Ⓢ<br>▲2SJ509 (1.9)Ⓢ                             | ▲2SK3670 (1.7)         | ◆2SJ313 (5.0)<br>▼2SJ338 (5.0)<br>◆2SK2013 (5.0)<br>▼2SK2162 (5.0) | ◇2SK2992 (3.5)Ⓢ    | CP★TPC8404(2.55)Ⓢ<br>CN★TPC8404(1.7)Ⓢ | ▼2SK3498 (5.5)Ⓢ                    | ⌈2SK4023 (4.6)Ⓢ<br>☆2SK3374 (4.6)Ⓢ<br>▼2SK3472 (4.6)Ⓢ |                                      |                                    |     |     | ⌈2SK3371 (9)Ⓢ<br>⌈2SK4026 (9)Ⓢ                      | ■2SK2733 (9.0)Ⓢ<br>▼2SK2845 (9)Ⓢ<br>▼2SK3301 (20)Ⓢ  |   |   | 1   |
| 1.1                                       |   | △SSM6K06FU (0.16)Ⓢ  |    | △SSM3J112TU (0.79)Ⓢ   |                       |                        |                                   |  |                        |  |                    |                                       |                                    |   |                                      |                                    |     |     |   |   |   |   | 1.1 |
| 1.2                                       | ▲SSM6J23FE (0.16)Ⓢ  | △SSM3K106TU (0.53)Ⓢ<br>●SSM6P54TU (0.228)Ⓢ<br>NS *SSM5H07TU (0.54)Ⓢ<br>▲SSM6K31FE (0.54)Ⓢ<br>▲SSM6K30FE (0.42)Ⓢ   |    |   |                       |                        |                                   |  |                        |  |                    |                                       |                                    |   |                                      |                                    |     |     |   |   |   |   | 1.2 |
| 1.3                                       |   | △SSM6J08FU (0.18)Ⓢ<br>PS *TPC8BA1 (0.18)Ⓢ   |    | ▲SSM6J207FE (0.491)Ⓢ  |                       |                        |                                   |  |                        |  | ⌈TPCS8004-H (0.8)Ⓢ |                                       |                                    |   |                                      |                                    |     |     |   |   |   |   | 1.3 |
| 1.4                                       | NS *SSM5H03TU (0.3)Ⓢ  | ▲SSM6K22FE (0.17)Ⓢ  |    | △SSM3J118TU (0.48)Ⓢ<br>●SSM6P40TU (0.403)Ⓢ<br>PS *SSM5G11TU (0.403)Ⓢ<br>NS *SSM5H01TU (0.45)Ⓢ<br>▲SSM6K210FE (0.371)Ⓢ |                       |                        |                                   |  |                        |  |                    |                                       |                                    |   |                                      |                                    |     |     |   |   |   |   | 1.4 |
| 1.5                                       | PS *SSM5G09TU (0.13)Ⓢ   | △SSM3K107TU (0.41)Ⓢ<br>●SSM6P39TU (0.213)Ⓢ<br>NS *SSM5H05TU (0.16)Ⓢ<br>NS *SSM5H08TU (0.16)Ⓢ  |    | ⊕SSM3J02T (0.5)Ⓢ<br>△SSM3K128TU (0.36)Ⓢ<br>PS *SSM5G10TU (0.213)Ⓢ<br>△SSM6K07FU (0.22)Ⓢ                               |                       |                        |                                   |  |                        |  |                    |                                       |                                    |   |                                      |                                    |     |     |   |   |   |   | 1.5 |
| 1.6                                       |   | ▲SSM6N42FE (0.252)Ⓢ<br>NS *SSM5H10TU (0.119)Ⓢ<br>NS *TPC8AA1 (0.105)Ⓢ<br>●SSM6L39TU (0.119)Ⓢ<br>●SSM6N39TU (0.119)Ⓢ<br>△SSM6K08FU (0.105)Ⓢ                        |    | ⊕SSM3J313T (0.268)Ⓢ<br>NS *SSM5H11TU (0.182)Ⓢ<br>●SSM6L40TU (0.182)Ⓢ<br>●SSM6N40TU (0.182)Ⓢ                           |                       |                        |                                   |  |                        |  |                    |                                       |                                    |   |                                      |                                    |     |     |   |   |   |   | 1.6 |
| 1.7                                       |   | △SSM3J113TU (0.169)Ⓢ  |    | ⊕SSM3J01T (0.4)Ⓢ<br>⊕SSM3J305T (0.477)Ⓢ   |                       |                        |                                   |  |                        |  |                    |                                       |                                    |   |                                      |                                    |     |     |   |   |   |   | 1.7 |
| 1.8                                       | PD *SSM6E03TU (0.144)Ⓢ  | △SSM3J108TU (0.158)Ⓢ<br>△SSM3J114TU (0.149)Ⓢ<br>PD *SSM6E02TU (0.136)Ⓢ<br>▲SSM6J53FE (0.136)Ⓢ   |    |   |                       |                        |                                   |  |                        |  |                    | ★TPC8012-H (0.4)Ⓢ                     |                                    |   |                                      |                                    |     |     |   |   |   |   | 1.8 |
| 1.9                                       |   |   |    | NS *SSM5H12TU (0.133)Ⓢ<br>▲SSM6K208FE (0.133)Ⓢ  |                       |                        |                                   |  |                        |  |                    |                                       | NS *TPCS8007-H (0.45)Ⓢ             |   |                                      |                                    |     |     |   |   |   |   | 1.9 |
| 2   |   | △SSM3J109TU (0.13)Ⓢ<br>△SSM3K122TU (0.123)Ⓢ<br>●SSM6K405TU (0.126)Ⓢ<br>▲SSM6J206FE (0.13)Ⓢ<br>▲SSM6K204FE (0.126)Ⓢ<br>⊕SSM3J46CTB (0.103)Ⓢ<br>*SSM3J325F (0.155)Ⓢ |    | △SSM3J117TU (0.225)Ⓢ<br>△SSM3K127TU (0.123)Ⓢ<br>●SSM6J402TU (0.225)Ⓢ  |                       |                        |                                   | ◇2SK2615 (0.3)Ⓢ<br>▲2SK2961 (0.3)Ⓢ<br>◇2SK3658 (0.3)Ⓢ<br>●SSM6K407TU (0.44)Ⓢ<br>●SSM6K32TU (0.44)Ⓢ |                        |  |                    |                                       |                                    | ▼2SJ610 (2.55)Ⓢ                                       | ⊗2SK3757 (2.45)Ⓢ<br>⊗2SK3766 (2.45)Ⓢ | ☆2SK2599 (3.2)Ⓢ<br>⌈2SK3373 (3.2)Ⓢ |     |     |   | ☆2SK2846 (5.0)Ⓢ<br>⌈2SK2865 (5.0)Ⓢ<br>⊗2SK3767 (4.5)Ⓢ<br>⌈2SK4002 (5)Ⓢ<br>⌈TK2Q60D (4.3)Ⓢ |   |   | 2   |
| 2.1                                       |   |   |    | △SSM3K116TU (0.1)Ⓢ  |                       |                        |                                   |  | NS *TPCS8009-H (0.35)Ⓢ |  |                    |                                       |                                    |   |                                      |                                    |     |     |   |   |   | 2.1                                       |     |
| 2.2                                       |   | △SSM3J115TU (0.098)Ⓢ<br>△SSM3K101TU (0.103)Ⓢ  |    | △SSM3K105TU (0.2)Ⓢ  |                       |                        |                                   | ⊕TPC8003-H (0.18)Ⓢ<br>★TPC8214-H (0.18)Ⓢ   |                        |  |                    |                                       |                                    |   |                                      |                                    |     |     |   |   |   | 2.2                                       |     |
| 2.3                                       | △SSM3J110TU (0.094)Ⓢ<br>⊕SSM3J304T (0.127)Ⓢ                             |   |    | ▲SSM6K202FE (0.085)Ⓢ  |                       |                        |                                   |  |                        |  |                    |                                       |                                    |   |                                      |                                    |     |     |   |   |   | 2.3                                       |     |
| 2.4                                       |   |   |    | ⊕SSM3J306T (0.225)Ⓢ<br>△SSM3K124TU (0.12)Ⓢ  |                       |                        |                                   |  |                        |  |                    |                                       |                                    |   |                                      |                                    |     |     |   |   |   | 2.4                                       |     |
| 2.5                                       |   | ●SSM6J50TU (0.064)Ⓢ   |    | △SSM3K119TU (0.074)Ⓢ<br>⊕SSM3K02T (0.2)Ⓢ<br>●SSM6J401TU (0.145)Ⓢ  |                       |                        | ⊕SSM3K318T (0.145)Ⓢ               |  |                        |  |                    |                                       | ⌈2SJ567 (2.0)Ⓢ<br>⌈2SJ680 (2.0)Ⓢ   |   |                                      |                                    |     |     | ⊗TK3A60DA (2.8)Ⓢ                                    |   | ⊗2SK3566 (6.4)Ⓢ                                       | 2.5                                       |     |
| 2.6                                       |   | △SSM3K102TU (0.071)Ⓢ  |    |   |                       |                        |                                   |  |                        |  |                    |                                       |                                    |   |                                      |                                    |     |     |   |   |   | 2.6                                       |     |
| 2.7                                       | ⊕SSM3J312T (0.091)Ⓢ   | P# *TPC6105 (0.11)Ⓢ<br>P# *TPCF8301 (0.11)Ⓢ<br>PS# *TPCF8B01 (0.11)Ⓢ<br>P# *TPCF8103 (0.11)Ⓢ  |    | ⊕SSM3J14T (0.17)Ⓢ   |                       |                        |                                   |  |                        |  |                    |                                       |                                    |   |                                      |                                    |     |     |   |   |   | 2.7                                       |     |
| 2.8                                       |   | ▲SSM6K203FE (0.061)Ⓢ  |    |   |                       |                        |                                   |  |                        |  |                    |                                       |                                    |   |                                      |                                    |     |     |   |   |   | 2.8                                       |     |
| 2.9                                       |   |   |    | ⊕SSM3K303T (0.12)Ⓢ  |                       |                        |                                   |  |                        |  |                    |                                       |                                    |   |                                      |                                    |     |     |   |   |   | 2.9                                       |     |
| 3   | ⊕SSM3J13T (0.07)Ⓢ<br>●SSM6J21TU (0.05)Ⓢ                                 | N# *TPCF8201 (0.049)Ⓢ<br>NS# *TPCF8A01 (0.049)Ⓢ<br>P# *TPCF8302 (0.059)Ⓢ<br>P# *TPCF8303 (0.058)Ⓢ<br>△SSM3K104TU (0.056)Ⓢ<br>●SSM6K404TU (0.055)Ⓢ                 |    | ⊕SSM3K12T (0.175)Ⓢ<br>●SSM6K34TU (0.077)Ⓢ<br>NS *SSM5H14F (0.078)Ⓢ  |                       |                        |                                   | ☆2SK2200 (0.35)Ⓢ<br>☆2SK2201 (0.35)Ⓢ<br>⌈2SK4018 (0.35)Ⓢ   |                        |  |                    |                                       | ⌈2SK3462 (1.7)Ⓢ<br>⌈2SK4022 (1.7)Ⓢ |   | ◆2SK2862 (3.2)Ⓢ                      |                                    |     |     | ⌈2SK4003 (2.2)Ⓢ<br>⌈(Short lead)<br>⌈2SK3975 (2.2)Ⓢ | ■2SK2603 (3.6)Ⓢ<br>○2SK2883 (3.6)Ⓢ  | ■2SK2608 (4.3)Ⓢ<br>□2SK2719 (4.3)Ⓢ<br>⊗2SK3564 (4.3)Ⓢ |   | 3   |
| 3.2                                       |   | △SSM3K121TU (0.048)Ⓢ<br>▲SSM6K211FE (0.047)Ⓢ  |    | CP# *TPCF8402 (0.077)Ⓢ<br>P# *TPCF8304 (0.072)Ⓢ<br>⊕SSM3K01T (0.12)Ⓢ  |                       |                        |                                   |  |                        |  |                    |                                       |                                    |   |                                      |                                    |     |     |   |   |   | 3.2                                       |     |
| 3.3                                       |   | ▲SSM6J212FE (0.0434)Ⓢ   |    |   |                       |                        |                                   |  |                        |  |                    |                                       |                                    |   |                                      |                                    |     |     |   |   |   | 3.3                                       |     |
| 3.4                                       |   |   |    | CP# *TPCP8402 (0.072)Ⓢ  | P# *TPCP8403 (0.070)Ⓢ |                        |                                   |  |                        |  |                    |                                       |                                    |   |                                      |                                    |     |     |   |   |   | 3.4                                       |     |
| 3.5                                       |   | ⊕SSM3K301T (0.056)Ⓢ<br>*SSM3J327F (0.095)Ⓢ  |    | ⊕SSM3J314T (0.1)Ⓢ   |                       |                        |                                   |  |                        |  |                    |                                       |                                    |   |                                      |                                    |     |     | ⊗TK4A55DA (2.45)Ⓢ                                   | ■2SK3085 (2.2)Ⓢ<br>⊗2SK3567 (2.2)Ⓢ<br>⊗TK4A60DA (2.2)Ⓢ                                    |   | 3.5                                       |     |
| 3.6                                       |   | ⊕SSM3J317T (0.107)Ⓢ   |    |   |                       |                        |                                   |  |                        |  |                    |                                       |                                    |   |                                      |                                    |     |     |   |   |   | 3.6                                       |     |
| 3.8                                       |   | P# *TPCP8303 (0.04)Ⓢ  |    |   |                       |                        |                                   |  |                        |  |                    |                                       |                                    |   |                                      |                                    |     |     |   |   |   | 3.8                                       |     |
| 3.9                                       |   |   |    |   |                       | N# *TPC6006-H (0.075)Ⓢ |                                   |  |                        |  |                    |                                       |                                    |   |                                      |                                    |     |     |   |   |   | 3.9                                       |     |
| 4   | ●SSM6J51TU (0.054)Ⓢ   | △SSM3J120TU (0.038)Ⓢ<br>●SSM6K18TU (0.04)Ⓢ  |    | CN# *TPCF8402 (0.05)Ⓢ<br>CN# *TPCP8404 (0.05)Ⓢ<br>CP# *TPCP8404 (0.05)Ⓢ<br>⊕SSM3K316T (0.065)Ⓢ<br>⊕SSM3K14T (0.067)Ⓢ  |                       |                        |                                   |  |                        |  |                    |                                       | N# *TPCA8008-H (0.58)Ⓢ             |   |                                      |                                    |     |     | ⊗TK4A50D (2.0)Ⓢ                                     | ⊗TK4A55D (1.9)Ⓢ   | ⊗TK4A60D (1.7)Ⓢ                                       | ⊗2SK3798 (3.5)Ⓢ<br>○2SK1190 (3.8)         | 4   |

Legend **Product series** ①: π-MOSIII ②: π-MOSV ③: π-MOSVI ④: L<sup>2</sup>-π-MOSV ⑤: L<sup>2</sup>-π-MOSVI ⑥: U-MOS ⑦: π-MOSVII ⑧: π-MOSIV ⑨: DTMOI ⑩: DTMOII

**Package** ◇PW-Mini ⌈VS-8 ♥VS-6 ♣PS-8 ⊕STP ▲TO-92MOD ▼PW-Mold ⌈New PW-Mold ⊕TSON Advance ⌈New PW-Mold2 ▼DP ☆TPS ◀TSSOP Advance ⌈TSSOP-8 ★SOP-8  
 ⊕SOP-8 Lead Clamp ▶SOP Advance ◆TO-220NIS ⊗TO-220SIS ■TO-220AB ⊞TO-220(W) ♣TFP ○TO-220FL/SM  
 \*S-Mini ⊕TSM \*USM △UFM ☆SSM ⊕VESM ⊕CST3 ◇CST3B ⊕CST4 ⊕SMV ⊕US6 \*UF6  
 ⊕ES6 \*CST6D ⊕USV \*UFV ⊕ESV

Notes:  
 ( ) = R<sub>DS(on)</sub> max  
 \$ = 10-V drive  
 # = 2.5-V drive  
 \* = 1.8-V drive  
 † = High-speed diode  
 N = N-ch  
 P = P-ch  
 CN = Complementary N-ch  
 CP = Complementary P-ch  
 NS = N-ch + SBD  
 PS = P-ch + SBD  
 PD = P-ch + Driver (load switch)  
 [ ] = Under development

| V <sub>DSS</sub> (V)<br>I <sub>D</sub> (A) | 12  | 20   | 24                  | 30   | 40   | 50                                  | 60  | 100  | 150             | 180 | 200  | 250                                  | 400  | 450                                | 500  | 525              | 550                                | 600 | 650              | 700            | 800  | 900   | 1000           | V <sub>DSS</sub> (V)<br>I <sub>D</sub> (A) |                 |     |  |   |
|--|---|--|---------------------|--|--|-------------------------------------|---|--|-----------------|-----|--|--------------------------------------|--|------------------------------------|--|------------------|------------------------------------|-----|------------------|----------------|--|---|----------------|--|-----------------|-----|--|---|
| 4.2  |   | △SSM3K123TU (0.028)Ⓢ<br>●SSM6K403TU (0.028)Ⓢ   |                     | N★TPCP8201 (0.05)Ⓢ<br>CN★TPCP8402 (0.077)Ⓢ<br>+SSM3K320T (0.077)Ⓢ  |  |                                     |   |  |                 |     |  |                                      |  |                                    |  |                  |                                    |     |                  |                |  |   |                |  | 4.2             |     |  |   |
| 4.4  |   | △SSM3J130TU (0.025)Ⓢ   |                     | ●SSM6K406TU (0.038)Ⓢ   |  |                                     |   |  |                 |     |  |                                      |  |                                    |  |                  |                                    |     |                  |                |  |   |                |  | 4.4             |     |  |   |
| 4.5  |   | P★TPC6107 (0.055)Ⓢ   |                     | P★TPC6108 (0.06)Ⓢ<br>CP★TPC8405 (0.033)Ⓢ   |  |                                     |   |  |                 |     |  | J 2SK3342 (1.0)Ⓢ<br>J 2SK4021 (1.0)Ⓢ |  |                                    |  |                  |                                    |     |                  |                |  |   |                |  | 4.5             |     |  |   |
| 4.6  |   | △SSM3J129TU (0.046)Ⓢ   |                     |  |  |                                     |   |  |                 |     |  |                                      |  |                                    |  |                  |                                    |     |                  |                |  |   |                |  | 4.6             |     |  |   |
| 4.7  |   | +SSM3K309T (0.031)Ⓢ  |                     |  |  |                                     |   |  |                 |     |  |                                      |  |                                    |  |                  |                                    |     |                  |                |  |   |                |  | 4.7             |     |  |   |
| 4.8  |   |  |                     |  |  |                                     |   |  |                 |     |  |                                      |  |                                    |  |                  |                                    |     |                  |                |  |   |                |  | 4.8             |     |  |   |
| 5  | △SSM3J32TU (0.0178)Ⓢ                      | ★TPC8208 (0.05)Ⓢ<br>I TPC8209 (0.03)Ⓢ<br>N# I TPC8210 (0.03)Ⓢ<br>P# I TPC8303 (0.021)Ⓢ<br>P I TPC8302 (0.035)Ⓢ<br>P★TPC8301 (0.031)Ⓢ<br>P★TPC8302 (0.033)Ⓢ<br>+SSM3J307T (0.031)Ⓢ<br>+SSM3K310T (0.028)Ⓢ   |                     | I TPC8209 (0.05)Ⓢ<br>N# I TPC8001 (0.032)Ⓢ<br>P★TPC8104-H (0.065)Ⓢ<br>N# I TPC6007-H (0.054)Ⓢ<br>P I TPC6109-H (0.059)Ⓢ  |  | ▲2SK2989 (0.15)Ⓢ<br>▲2SJ537 (0.19)Ⓢ | J 2SJ668 (0.17)Ⓢ<br>J 2SJ681 (0.17)Ⓢ<br>☆2SJ378 (0.19)Ⓢ<br>☆2SJ669 (0.17)Ⓢ<br>◆2SJ438 (0.19)Ⓢ<br>☆2SK2229 (0.16)Ⓢ<br>J 2SK4017 (0.1)Ⓢ<br>J 2SK4033 (0.1)Ⓢ<br>★TPC8213-H (0.05)Ⓢ | J 2SK2399 (0.23)Ⓢ<br>☆2SK2400 (0.23)Ⓢ<br>J 2SK4019 (0.23)Ⓢ | ▼2SK3205 (0.52) |     | ◆2SJ407 (1.0)Ⓢ<br>◆2SK2381 (0.8)Ⓢ<br>☆2SK2835 (0.8)Ⓢ<br>J 2SK2920 (0.8)Ⓢ<br>J 2SK4020 (0.8)Ⓢ | ◆2SJ512 (1.25)Ⓢ                      |  |                                    | ○2SK2991 (1.5)Ⓢ<br>◆2SK3466 (1.5)Ⓢ<br>▽2SK3863 (1.5)Ⓢ<br>J 2SK4103 (1.5)Ⓢ<br>Y○2SK3417 (1.8)Ⓢ<br>Y○2SK3868 (1.7)Ⓢ<br>○TK5A50D (1.5)Ⓢ |                  | ⊗TK5A55D (1.88)Ⓢ                   |     | ⊗TK5A65D (1.45)Ⓢ | ◆2SK2274 (1.7) | ○2SK2884 (2.2)Ⓢ  | ⊗2SK3565 (2.5)Ⓢ<br>□2SK3700 (2.5)Ⓢ<br>⊗2SK3742 (2.5)Ⓢ | □2SK1359 (3.8) |  | 5               |     |  |   |
| 5.2  |   | +SSM3J321T (0.046)Ⓢ  |                     |  |  |                                     |   |  |                 |     |  |                                      |  |                                    |  |                  |                                    |     |                  |                |  |   |                |  | 5.2             |     |  |   |
| 5.5  | PD★TPC8401 (0.038)Ⓢ<br>P★TPC6103 (0.035)Ⓢ | P★TPC6111 (0.04)Ⓢ  |                     | N★TPC8211 (0.036)Ⓢ<br>N★TPC8202 (0.023)Ⓢ   |  |                                     |   |  |                 |     |  | N▶TPCA8010-H (0.45)Ⓢ                 | ○2SK2838 (1.2)Ⓢ<br>◆2SK2679 (1.2)Ⓢ                                     |                                    |  |                  |                                    |     |                  |                | ⊗TK6A55DA (1.48)Ⓢ  |   |                |  | 5.5             |     |  |   |
| 5.6  |   | P★TPC8101 (0.030)Ⓢ   |                     | +SSM3J326T (0.0457)Ⓢ   |  |                                     |   |  |                 |     |  |                                      |  |                                    |  |                  |                                    |     |                  |                |  |   |                |  | 5.6             |     |  |   |
| 6  | P★TPCF8101 (0.028)Ⓢ                       | N▶TPCT4201 (0.031)Ⓢ<br>N▶TPCT4203 (0.031)Ⓢ<br>N#▶TPC6004 (0.024)Ⓢ<br>P★TPCF8102 (0.030)Ⓢ<br>★TPC8207 (0.02)Ⓢ<br>I TPC8211 (0.024)Ⓢ<br>I TPC8204 (0.017)Ⓢ<br>P# I TPC8102 (0.02)Ⓢ<br>P# I TPC8302 (0.035)Ⓢ<br>N# I TPC8212 (0.024)Ⓢ<br>N# I TPC8208 (0.017)Ⓢ<br>N I TPC8213 (0.013)Ⓢ<br>N▶TPCL4201 (0.031)Ⓢ | N▶TPCL4203 (0.036)Ⓢ | N▶TPCT4202 (0.038)Ⓢ<br>N▶TPCT4204 (0.038)Ⓢ<br>N#▶TPC6011 (0.020)Ⓢ<br>N#▶TPC6005 (0.028)Ⓢ<br>PD▶TPCF801 (0.025)Ⓢ<br>P▶TPCF8104 (0.028)Ⓢ<br>N I TPC8214 (0.135)Ⓢ<br>NS▶TPC8A01 (0.025)Ⓢ<br>★TPC8212-H (0.021)Ⓢ<br>CN★TPC8405 (0.026)Ⓢ<br>+SSM3K315T (0.0415)Ⓢ<br>N▶TPCL4202 (0.04)Ⓢ<br>△SSM3K131TU (0.0415)Ⓢ |  |                                     |   |  |                 |     |  |                                      |  | ◆2SJ516 (0.8)Ⓢ                     |  | ⊗TK6A50D (1.48)Ⓢ | ⊗TK6A53D (1.3)Ⓢ<br>▽TK6P53D (1.3)Ⓢ |     |                  |                | □2SK2602 (1.25)Ⓢ<br>○2SK2777 (1.25)Ⓢ<br>◆2SK3312 (1.25)Ⓢ<br>⊗TK6A60D (1.25)Ⓢ<br>Y⊗2SK3947 (1.4)Ⓢ | ⊗TK6A65D (1.11)Ⓢ                                      |                | ⊗2SK4013 (1.7)Ⓢ                            | ⊗2SK4014 (2.0)Ⓢ |     |  | 6 |
| 6.5  |   |  |                     | N★TPC8216-H (0.020)Ⓢ   |  |                                     |   |  |                 |     |  |                                      |  |                                    |  |                  |                                    |     |                  |                |  |   |                |  | 6.5             |     |  |   |
| 7  |   |  |                     | N▶TPCF8001 (0.023)Ⓢ<br>N▶TPCF8002 (0.023)Ⓢ   | CNTPC8406-H (0.027)Ⓢ<br>CP TPC8406-H (0.03)Ⓢ   |                                     |   |  |                 |     |  |                                      |  |                                    |  |                  |                                    |     |                  |                |  |   |                |  | 7               |     |  |   |
| 7.2  |   | P★TPCF8102 (0.018)Ⓢ  |                     | N▶TPC8001-H (0.016)Ⓢ   |  |                                     |   |  |                 |     |  |                                      |  |                                    |  |                  |                                    |     |                  |                |  |   |                |  | 7.2             |     |  |   |
| 7.5  |   |  |                     |  | N▶TPCA8020-H (0.027)Ⓢ<br>N★TPC8022-H (0.027)Ⓢ<br>P★TPC8116-H (0.03)Ⓢ<br>P▶TPCA8107-H (0.03)Ⓢ |                                     |   |  |                 |     |  |                                      |  | ◆2SK2417 (0.5)Ⓢ<br>■2SK2914 (0.5)Ⓢ |  |                  |                                    |     |                  |                | ⊗TK6A55DA (1.07)Ⓢ<br>⊗TK6A60DA (1.0)Ⓢ  |   |                |  |                 | 7.5 |  |   |
| 8  |   |  |                     | N★TPC8210 (0.015)Ⓢ<br>N★TPC8021-H (0.017)Ⓢ   | P★TPC8110 (0.025)Ⓢ   |                                     |   |  |                 |     |  |                                      |  |                                    |  |                  |                                    |     |                  |                |  |   |                |  | 8               |     |  |   |
| 8.3  |   |  |                     | N▶TPCF8004 (0.009)Ⓢ  |  |                                     |   |  |                 |     |  |                                      |  |                                    |  |                  |                                    |     |                  |                |  |   |                |  | 8.3             |     |  |   |
| 8.5  |   |  |                     | NS★TPC8A01 (0.018)Ⓢ  |  |                                     |   |  |                 |     |  |                                      |  |                                    |  |                  |                                    |     |                  |                |  |   |                |  | 8.5             |     |  |   |
| 9  |   | N▶TPC8006 (0.01)Ⓢ  |                     |  |  |                                     |   |  |                 |     |  |                                      |  |                                    |  |                  |                                    |     |                  |                |  |   |                |  | 9               |     |  |   |
| 9.5  |   | ●SSM6J409TU (0.0221)Ⓢ  |                     |  |  |                                     |   |  |                 |     |  |                                      |  |                                    |  |                  |                                    |     |                  |                |  |   |                |  | 9.5             |     |  |   |
| 10   |   | P★TPC8115 (0.01)Ⓢ  |                     | P★TPC8109 (0.02)Ⓢ<br>P★TPC8119 (0.012)Ⓢ<br>NS▶TPCA805-H (0.012)Ⓢ   |  |                                     |   |  |                 |     | J 2SK3669 (0.125)Ⓢ   |                                      | □2SJ200 (0.83)<br>□2SK1529 (0.83)<br>□2SK3497 (0.15)<br>□2SJ618 (0.37) |                                    |  |                  |                                    |     |                  |                |  |   |                |  |                 | 10  |  |   |

Legend

**Product series** ①: π-MOSIII ②: π-MOSV ③: π-MOSVI ④: L<sup>2</sup>-π-MOSV ⑤: L<sup>2</sup>-π-MOSVI ⑥: U-MOS ⑦: π-MOSVII ⑧: π-MOSIV ⑨: DTMOSI ⑩: DTMOSII

**Package** ◊PW-Mini } VS-8 ♥VS-6 ♣PS-8 ◊STP ▲TO-92MOD ▼PW-Mold } New PW-Mold ○TSON Advance  
 ◊SOP-8 Lead Clamp ▶SOP Advance ◆TO-220NIS ⊗TO-220SIS ■TO-220AB □TO-220(W) ◆TFP ○TO-220FL/SM  
 \*S-Mini +TSM \*USM △UFM ⊙SSM +VESM +CST3 ◊CST3B ⊙CST4 +SMV /US6 \*UF6 +ES6 \*CST6D \USV \*UFV ⊙ESV

◊ New PW-Mold2 ▽DP ☆TPS ◊TSSOP Advance X TSSOP-8 ★SOP-8  
 ◆TO-220SM(W) □TO-3P(N) ○TO-3P(N)IS ●TO-3P(L) □Chip LGA

Notes:  
 ( ) = R<sub>DS(on)</sub> max \* = 1.8-V drive P = P-ch NS = N-ch + SBD PD = P-ch + Driver  
 \$ = 10-V drive Y = High-speed diode CN = Complementary N-ch PS = P-ch + SBD (load switch)  
 # = 2.5-V drive N = N-ch CP = Complementary P-ch [ ] = Under development

| V <sub>DSS</sub> (V)<br>I <sub>D</sub> (A) | 20 | 30  | 40   | 50                 | 60   | 75                    | 80   | 100  | 150 | 200                                    | 250  | 300 | 450               | 500  | 525                                      | 550                | 600  | 900/1000  | V <sub>DSS</sub> (V)<br>I <sub>D</sub> (A) |      |    |
|--|----|---|--|--------------------|--|-----------------------|--|--|-----|--|--|-----|-------------------|--|--|--------------------|--|---|--|------|----|
| 11   |    | N★TPC8025 (0.009)Ⓢ<br>N★TPC8021-H (0.017)Ⓢ<br>N★TPC8014 (0.014)Ⓢ<br>P★TPC8111 (0.012)Ⓢ<br>P★TPC8113 (0.01)Ⓢ<br>P I TPC8105 (0.0135)Ⓢ<br>P I TPC8104 (0.012)Ⓢ<br>N★TPC8030 (0.0095)<br>N★TPC8031-H (0.0133)Ⓢ<br>N★TPC8005-H (0.0129)Ⓢ<br>P★TPC8121 (0.012)Ⓢ<br>P★TPC8123 (0.0090)Ⓢ                                 |  |                    |  | N★TPC8050-H (0.0145)Ⓢ |  |  |     |  | ◆ 2SK2965 (0.26)Ⓢ  |     |                   |  |  |                    |  | ⊗ TK11A55D (0.63)Ⓢ  | ⊗ TK11A60D (0.65)Ⓢ                         |      | 11 |
| 12   |    | N★TPC8037-H (0.0114)Ⓢ<br>N★TPC8038-H (0.0114)Ⓢ<br>NS★TPC8A06-H (0.0101)Ⓢ  | N★TPC8052-H (0.0115)Ⓢ                          |                    |  |                       |  | ◆ 2SJ380 (0.21)Ⓢ                           |     | ◆ 2SJ201 (0.625)<br>◆ 2SK1530 (0.625)  |  |     |                   | ○ 2SK3068 (0.52)Ⓢ<br>◆ 2SK3398 (0.52)Ⓢ<br>⊗ TK12A50D (0.52)Ⓢ<br>¥◆ 2SK3313 (0.62)Ⓢ | ⊗ TK12A53D (0.58)Ⓢ<br>◆ TK12X53D (0.58)Ⓢ | □ TK12J55D (0.57)Ⓢ | □ 2SK2699 (0.65)Ⓢ<br>⊗ TK12A60U (0.4)Ⓢ<br>⊗ TK12D60U (0.4)Ⓢ<br>□ TK12J60U (0.4)Ⓢ<br>⊗ TK12A60D (0.55)Ⓢ | 1000V: ◆ 2SK1489 (1.0)  |  | 12   |    |
| 12.5                                       |    |   |  |                    |  |                       |  |  |     |  |  |     |                   | ⊗ TK13A50DA (0.47)Ⓢ  |  |                    |  |   |  | 12.5 |    |
| 13   |    | N★TPC8041 (0.007)Ⓢ<br>N★TPC8026 (0.0066)Ⓢ<br>P★TPC8107 (0.007)Ⓢ<br>P★TPC8112 (0.006)Ⓢ<br>P★TPC8118 (0.007)Ⓢ<br>N★TPC8003-H (0.0169)Ⓢ<br>N★TPC8040-H (0.0097)Ⓢ   |  |                    |  | N★TPC8049-H (0.0107)Ⓢ |  | N★TPC8051-H (0.0097)Ⓢ                      |     |  | ◆ 2SK2508 (0.25)Ⓢ<br>○ 2SK2598 (0.25)Ⓢ                         |     |                   | ◆ 2SK3743 (0.4)Ⓢ<br>○ 2SK3403 (0.4)Ⓢ<br>◆ 2SK3544 (0.4)Ⓢ<br>⊗ TK13A45D (0.46)Ⓢ     | ⊗ TK13A50D (0.4)Ⓢ                        |                    |  | ⊗ TK13A60D (0.43)Ⓢ<br>¥⊗ 2SK4016 (0.5)Ⓢ   | 900V: □ 2SK4207 (0.95)                     |      | 13 |
| 14   |    |   |  |                    | ◆ 2SJ304 (0.12)<br>2SJ312 (0.12)                             |                       |  |  |     |  |  |     |                   | ○ 2SK2916 (0.4)Ⓢ   |  | ⊗ TK14A55D (0.37)Ⓢ | □ 2SK3903 (0.44)Ⓢ  |   |  | 14   |    |
| 15   |    | N★TPC8032-H (0.0065)Ⓢ<br>P★TPC8102 (0.0189)Ⓢ  |  |                    | ▶ TPCA8053-H (0.0223)Ⓢ                                       |                       |  |  |     | ◆ 2SK2382 (0.18)Ⓢ<br>○ 2SK2401 (0.18)Ⓢ |  |     |                   | ⊗ TK15A50D (0.3)Ⓢ<br>¥□ 2SK3314 (0.49)Ⓢ<br>□ TK15J50D (0.4)Ⓢ                       |  |                    | ⊗ 2SK2953 (0.4)Ⓢ<br>⊗ TK15A60U (0.3)Ⓢ<br>⊗ TK15D60U (0.3)Ⓢ<br>□ TK15J60U (0.3)Ⓢ<br>⊗ TK15A60D (0.37)Ⓢ  |   |  | 15   |    |
| 16   |    | NS★TPC8A02-H (0.0056)Ⓢ  | N★TPC8047-H (0.0076)Ⓢ                          |                    | N★TPC8048-H (0.0069)Ⓢ  |                       |  | ○ 2SJ412 (0.21)Ⓢ<br>◆ 2SJ619 (0.21)Ⓢ       |     |  |  |     |                   |  |  |                    | □ TK16J55D (0.37)Ⓢ   |   |  | 16   |    |
| 17   |    | N★TPC8033-H (0.0053)Ⓢ<br>NS★TPC8A03-H (0.0056)Ⓢ<br>N★TPC8039-H (0.006)Ⓢ   |  |                    |  |                       |  |  |     |  |  |     | ⊗ 2SK3935 (0.25)Ⓢ | □ 2SK3905 (0.31)Ⓢ  |  |                    |  |   |  |      | 17 |
| 18   |    | P★TPC8114 (0.0045)Ⓢ<br>N★TPC8027 (0.0027)Ⓢ<br>N★TPC8028 (0.0043)Ⓢ<br>N★TPC8029 (0.0038)Ⓢ<br>N★TPC8034-H (0.0035)Ⓢ<br>N★TPC8042 (0.0034)Ⓢ<br>P★TPC8117 (0.0039)Ⓢ<br>N★TPC8036-H (0.0045)Ⓢ<br>NS★TPC8A04-H (0.0036)Ⓢ<br>P★TPC8120 (0.0032)Ⓢ<br>P★TPC8103 (0.012)Ⓢ<br>N★TPC8035-H (0.0032)Ⓢ<br>N★TPC8060-H (0.0037)Ⓢ | N★TPC8045-H (0.0039)Ⓢ<br>N★TPC8046-H (0.0057)Ⓢ |                    |  |                       | ◆ 2SJ464 (0.12)Ⓢ<br>◆ 2SJ620 (0.09)Ⓢ<br>▶ TPCA8006-H (0.067) |  |     | ◆ 2SK2882 (0.12)Ⓢ<br>◆ 2SK3387 (0.12)Ⓢ |  |     |                   |  | ○ 2SK2917 (0.27)Ⓢ<br>⊗ TK18A50D (0.27)Ⓢ  |                    |  |   |  |      | 18 |
| 19   |    |   |  |                    |  |                       |  |  |     |  |  |     |                   | □ 2SK3904 (0.26)Ⓢ  |  |                    |  |   |  |      | 19 |
| 20   |    | NS★TPC8A05-H (0.0129)Ⓢ<br>NS▶ TPCA8A05-H (0.0129)Ⓢ<br>N★TPC8001-H (0.0095)Ⓢ   | N▶ TPCA8052-H (0.0115)Ⓢ                        | ▽ 2SK2614 (0.046)Ⓢ | ◆ 2SJ349 (0.045)Ⓢ<br>○ 2SJ401 (0.045)Ⓢ<br>▽ 2SK2782 (0.055)Ⓢ |                       |  | ◆ 2SK2391 (0.085)Ⓢ<br>⊗ TJ20A10M3 (0.090)Ⓢ |     |  | ○ 2SK2993 (0.105)Ⓢ<br>◆ 2SK3445 (0.105)Ⓢ<br>◆ 2SK3994 (0.105)Ⓢ |     |                   |  | □ TK20J50D (0.27)Ⓢ                       |                    |  | □ 2SK3911 (0.32)Ⓢ<br>⊗ TK20A60U (0.19)Ⓢ<br>⊗ TK20D60U (0.19)Ⓢ<br>□ TK20J60U (0.19)Ⓢ<br>¥□ 2SK3906 (0.33)Ⓢ |  |      | 20 |
| 21   |    | N★TPC8003-H (0.0129)Ⓢ<br>NS★TPC8A01-H (0.0099)Ⓢ   |  |                    |  |                       |  |  |     |  |  |     |                   |  |  |                    |  |   |  |      | 21 |
| 22   |    | N★TPC8001-H (0.0083)Ⓢ<br>N★TPC8002-H (0.0083)Ⓢ<br>N★TPC8006-H (0.008)Ⓢ  |  |                    |  |                       |  | ▶ TPCA8022-H (0.026)Ⓢ                      |     |  |  |     |                   |  |  |                    |  |   |  |      | 22 |
| 23   |    | N▶ TPCA8040-H (0.0094)Ⓢ   |  |                    |  |                       |  |  |     |  |  |     |                   |  |  |                    |  | □ 2SK3907 (0.23)Ⓢ<br>¥□ 2SK3936 (0.25)Ⓢ   |  |      | 23 |

Legend **Product series** ① : π-MOSIII ② : π-MOSV ③ : π-MOSVI ④ : L<sup>2</sup>-π-MOSV ⑤ : L<sup>2</sup>-π-MOSVI ⑥ : U-MOS ⑦ : π-MOSVII ⑧ : π-MOSIV ⑨ : DTMOI ⑩ : DTMOII

**Package** ◊PW-Mini ↵VS-8 ♥VS-6 ♣PS-8 ⊕STP ▲TO-92MOD ▼PW-Mold ↵New PW-Mold ⊕TSON Advance ♪New PW-Mold2 ▽DP ☆TPS ◀TSSOP Advance ✕TSSOP-8 ★SOP-8 ◊SOP-8 Lead Clamp ▶SOP Advance ◆TO-220NIS ⊗TO-220SIS ■TO-220AB ⊞TO-220(W) ◆TFP ○TO-220FL/SM

\* S-Mini †TSM \*USM △UFM ☆SSM †VESM †CST3 ◊CST3B ⊗CST4 †SMV ∠US6 \*UF6 †ES6 \*CST6D ^USV \*UFV ⊕ESV

Notes:  
 ( ) = R<sub>DS(on)</sub> max \* = 1.8-V drive P = P-ch  
 \$ = 10-V drive † = High-speed diode CN = Complementary N-ch PS = P-ch + SBD PD = P-ch + Driver  
 # = 2.5-V drive N = N-ch CP = Complementary P-ch [ ] = Under development (load switch)

| V <sub>DSS</sub> (V)<br>I <sub>D</sub> (A) | 20                      | 30  | 40   | 50   | 60  | 75   | 80                      | 100                  | 150  | 200                                      | 250 | 300 | 450 | 500                                    | 525 | 550 | 600                | 900/1000 | V <sub>DSS</sub> (V)<br>I <sub>D</sub> (A) |
|--|-------------------------|---|--|--|---|--|-------------------------|----------------------|--|--|-----|-----|-----|--|-----|-----|--------------------|----------|--|
| 24   |                         | N ▶ TPC8004-H (0.011)Ⓢ<br>N ▶ TPC8030-H (0.011)Ⓢ<br>N ▶ TPC8031-H (0.011)Ⓢ  |  |  | N ▶ TPC8050-H (0.014)Ⓢ  |  |                         |                      |  |  |     |     |     |  |     |     |                    |          | 24   |
| 25   |                         | P ◀ TPC8102 (0.0077)Ⓢ<br>N ◀ TPC8006 (0.007)Ⓢ<br>N ⊕ TPCC8008 (0.0068)Ⓢ   |  | ◆ 2SK2507 (0.046)Ⓢ   | ◆ 2SK2232 (0.046)Ⓢ<br>○ 2SK2311 (0.046)Ⓢ<br>N ▶ TPC8016-H (0.021)Ⓢ  |  |                         | ⊗ TK25A10K3 (0.040)Ⓢ |  | ◆ 2SK3444 (0.082)Ⓢ<br>○ 2SK3625 (0.082)Ⓢ |     |     |     | ● 2SK1544 (0.2)                        |     |     |                    |          | 25   |
| 26   |                         | N ⊕ TPCC8005-H (0.0064)Ⓢ  | ◆ 2SK3846 (0.016)Ⓢ   |  |   |  |                         |                      |  |  |     |     |     |  |     |     |                    |          | 26   |
| 27   | N ⊕ TPCC8007 (0.0046)Ⓢ  |   |  |  |   |  |                         |                      |  |  |     |     |     |  |     |     |                    |          | 27   |
| 28   |                         |   |  |  | N ▶ TPC8049-H (0.0104)Ⓢ   |  | N ▶ TPC8051-H (0.0094)Ⓢ |                      |  |  |     |     |     |  |     |     |                    |          | 28   |
| 30   |                         | N ▶ TPC8018-H (0.0062)Ⓢ<br>N ◀ TPC8002-H (0.0062)Ⓢ  | N ▶ TPC8014-H (0.009)Ⓢ<br>N ▶ TPC8027-H (0.010)Ⓢ                         |  | ◆ 2SJ334 (0.038)Ⓢ<br>○ 2SJ402 (0.038)Ⓢ<br>⊗ TK30A06J3A (0.026)Ⓢ   |  |                         | ◆ 2SK3443 (0.055)Ⓢ   | □ 2SK3176 (0.052)Ⓢ   | □ 2SK2967 (0.068)Ⓢ<br>⊗ 2SK2995 (0.068)Ⓢ |     |     |     |  |     |     |                    | 30       |  |
| 32   |                         |   | ○ 2SK3847 (0.016)Ⓢ<br>N ▶ TPC8047-H (0.0073)Ⓢ                            |  |   |  |                         |                      |  |  |     |     |     | ● 2SK1486 (0.095)                      |     |     |                    |          | 32   |
| 34   |                         | NS ▶ TPC8A02-H (0.0053)Ⓢ<br>N ▶ TPC8039-H (0.0057)Ⓢ   |  |  |   |  |                         |                      |  |  |     |     |     |  |     |     |                    |          | 34   |
| 35   |                         | N ▶ TPC8024 (0.0043)Ⓢ   | N ▶ TPC8015-H (0.0054)Ⓢ  |  | ◆ 2SK3662 (0.0125)Ⓢ<br>N ▶ TPC8048-H (0.0066)Ⓢ  |  |                         |                      |  |  |     |     |     |  |     |     |                    |          | 35   |
| 36   |                         |   |  |  | ◆ 2SK2385 (0.03)Ⓢ   |  |                         |                      |  |  |     |     |     |  |     |     |                    |          | 36   |
| 38   |                         | NS ▶ TPC8A08-H (0.0042)Ⓢ<br>N ▶ TPC8036-H (0.0038)Ⓢ   | N ▶ TPC8046-H (0.0054)Ⓢ  |  |   |  |                         |                      |  |  |     |     |     |  |     |     |                    |          | 38   |
| 40   | N ▶ TPC8011-H (0.0035)Ⓢ | P ▶ TPC8102 (0.006)Ⓢ<br>P ▶ TPC8103 (0.0042)Ⓢ<br>P ▶ TPC8106 (0.0037)Ⓢ<br>N ▶ TPC8012-H (0.0049)Ⓢ<br>N ▶ TPC8025 (0.0036)Ⓢ<br>N ▶ TK40P03M1 (0.0108)Ⓢ | P ▶ TPC8108 (0.0095)Ⓢ<br>N ▶ TK40P04M1 (0.011)Ⓢ                          |  | P ▶ TPC8104 (0.016)Ⓢ  | ⊗ TK40A08K3 (0.009)Ⓢ                           |                         |                      | ⊠ TK40D10J1 (0.015)Ⓢ<br>⊗ TK40A10J1 (0.015)Ⓢ<br>⊗ TK40A10K3 (0.015)Ⓢ<br>◆ TK40X10J1 (0.020)Ⓢ |  |     |     |     |  |     |     | □ TK40J60T (0.08)Ⓢ | 40       |  |
| 44   |                         | NS ▶ TPC8A04-H (0.0032)Ⓢ  |  |  |   |  |                         |                      |  |  |     |     |     |  |     |     |                    |          | 44   |
| 45   |                         | □ 2SK3506 (0.02)<br>N ▶ TPC8019-H (0.0031)Ⓢ<br>N ▶ TPC8026 (0.0022)Ⓢ<br>N ▶ TPC8042 (0.0033)Ⓢ<br>N ▶ TPC8060-H (0.0034)Ⓢ                              |  | □ 2SK2550 (0.03)Ⓢ<br>◆ 2SK2886 (0.02)Ⓢ<br>□ 2SK2744 (0.02)Ⓢ<br>□ 2SK3051 (0.03)Ⓢ | □ 2SK2233 (0.03)Ⓢ<br>○ 2SK2266 (0.03)Ⓢ<br>○ 2SK2376 (0.017)Ⓢ<br>□ 2SK2398 (0.03)Ⓢ<br>◆ 2SK3844 (0.0058)Ⓢ              |  |                         |                      |  |  |     |     |     |  |     |     |                    |          | 45   |
| 46   |                         |   | N ▶ TPC8045-H (0.0036)Ⓢ  |  |   |  |                         |                      |  |  |     |     |     |  |     |     |                    |          | 46   |
| 50   |                         | N ▶ TPC8028-H (0.0028)Ⓢ<br>N ▶ TK50P03M1 (0.0075)Ⓢ  | N ▶ TK50P04M1 (0.0087)Ⓢ  | □ 2SK2551 (0.011)Ⓢ<br>□ 2SK2745 (0.0095)Ⓢ  | □ 2SK2173 (0.017)Ⓢ<br>□ 2SK2445 (0.018)Ⓢ  |  |                         | □ 2SK1381 (0.032)    | ◆ TK50X15J1 (0.03)Ⓢ<br>◆ TK50F15J1 (0.03)Ⓢ   |  |     |     |     | ● 2SK3132 (0.09)Ⓢ<br>◆ 2SK3131 (0.11)Ⓢ |     |     |                    | 50       |  |
| 55   |                         |   |  |  |   |  |                         |                      |  |  |     |     |     |  |     |     |                    |          | 55   |
| 60   |                         |   |  |  | ● 2SK2267 (0.011)Ⓢ<br>□ 2SK2313 (0.011)Ⓢ  | ⊠ TK60D08J1 (0.0078)Ⓢ<br>⊗ TK60A08J1 (0.0078)Ⓢ |                         |                      | ● 2SK1382 (0.020)  |  |     |     |     |  |     |     |                    |          | 60   |
| 70   |                         |   | □ TK70J04J3 (0.0038)Ⓢ<br>◆ TK70X04K3 (0.0056)Ⓢ<br>◆ TK70X04K3L (0.0056)Ⓢ |  | □ 2SK3845 (0.0058)Ⓢ<br>⊠ TK70D06J1 (0.0064)Ⓢ<br>⊗ TK70A06J1 (0.0064)Ⓢ<br>⊗ TJ70A06J3 (0.008)Ⓢ<br>◆ TK70X06K3 (0.008)Ⓢ |  |                         |                      |  |  |     |     |     |  |     |     |                    |          | 70   |
| 75   |                         |   | ◆ 2SK3843 (0.0035)Ⓢ  |  | ◆ 2SK4034 (0.0058)Ⓢ<br>◆ 2SK3842 (0.0058)Ⓢ  |  |                         |                      |  |  |     |     |     |  |     |     |                    |          | 75   |
| 80   |                         |   | ◆ TK80X04K3 (0.0035)Ⓢ  |  |   | ⊗ TK80A08K3 (0.0045)Ⓢ<br>⊠ TK80D08K3 (0.0045)Ⓢ |                         |                      |  |  |     |     |     |  |     |     |                    |          | 80   |
| 100  |                         |   | ◆ TK100F04K3 (0.003)Ⓢ<br>◆ TK100F04K3L (0.003)Ⓢ                          |  | ◆ TK100F06K3 (0.005)Ⓢ   |  |                         |                      |  |  |     |     |     |  |     |     |                    |          | 100  |
| 120  |                         |   |  |  | ◆ TJ120F06J3 (0.008)Ⓢ   |  |                         |                      |  |  |     |     |     |  |     |     |                    |          | 120  |
| 130  |                         |   |  |  | ◆ TK130F06K3 (0.0034)Ⓢ  |  |                         |                      |  |  |     |     |     |  |     |     |                    |          | 130  |
| 150  |                         |   | ◆ TK150F04K3 (0.0021)Ⓢ<br>◆ TK150F04K3L (0.0021)Ⓢ                        |  |   |  |                         |                      |  |  |     |     |     |  |     |     |                    |          | 150  |

**Legend** **Product series** ① : π-MOSIII ② : π-MOSV ③ : π-MOSVI ④ : L<sup>2</sup>-π-MOSV ⑤ : L<sup>2</sup>-π-MOSVI ⑥ : U-MOS ⑦ : π-MOSVII ⑧ : π-MOSIV ⑨ : DTMOSI ⑩ : DTMOSII

**Package** ◊ PW-Mini ↗ VS-8 ♥ VS-6 ♣ PS-8 ⊕ STP ▲ TO-92MOD ▼ PW-Mold ↘ New PW-Mold ○ TSON Advance ⊞ SOP-8 Lead Clamp ▶ SOP Advance ◆ TO-220NIS ⊗ TO-220SIS ■ TO-220AB ⊞ TO-220(W) ◆ TFP ○ TO-220FL/SM \* S-Mini + TSM \* USM △ UFM ☆ SSM + VESM + CST3 ◊ CST3B ◊ CST4 + SMV / US6 \* UF6

⊞ New PW-Mold2 ▽ DP ☆ TPS ◀ TSSOP Advance ✕ TSSOP-8 ★ SOP-8 ⊞ TO-220SM(W) □ TO-3P(N) ○ TO-3P(N)IS ● TO-3P(L) ⊞ Chip LGA + ES6 \* CST6D △ USV \* UFV ☆ ESV ▷ DPAK

**Notes:**  
 ( ) = R<sub>DS(on)</sub> max \* = 1.8-V drive P = P-ch NS = N-ch + SBD PD = P-ch + Driver  
 \$ = 10-V drive ¥ = High-speed diode CN = Complementary N-ch PS = P-ch + SBD (load switch)  
 # = 2.5-V drive N = N-ch CP = Complementary P-ch [ ] = Under development

## 4-1 Packaging Options

### SSM Series

The SSM Series comes in small, thin packages suitable for portable devices. Chip-scale packages (1006 size) help reduce system size.

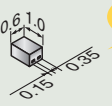
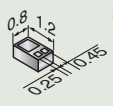
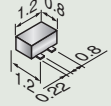
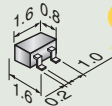
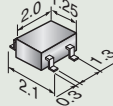
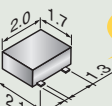
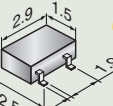
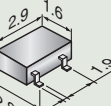
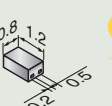
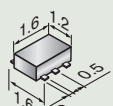
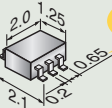
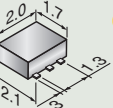
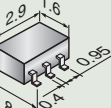
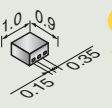
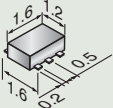
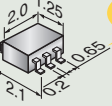
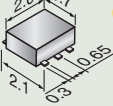
|   |   |  |  |   |
|---|---|--|--|---|
| <b>CST3</b><br>Chip-Scale Package, Transfer Molded, 3-Pin<br><b>Typical product: SSM3K35CT</b><br><br>Thickness: 0.38 typ.<br>Unit: mm | <b>CST3B</b><br>Chip-Scale Package, Transfer Molded, 3-Pin, B-Type<br><b>Typical product: SSM3J46CTB</b><br><br>Thickness: 0.48 typ.<br>Unit: mm | <b>VESM (SOT-723)</b><br>Very Extreme Super-Mini<br><b>Typical product: SSM3K35MFV</b><br><br>Thickness: 0.5 typ.<br>Unit: mm | <b>SSM (SOT-416)(SC-75)</b><br>Small Super-Mini<br><b>Typical product: SSM3K35FS</b><br><br>Thickness: 0.7 typ.<br>Unit: mm                        | <b>USM (SOT-323)(SC-70)</b><br>Ultra-Super-Mini<br><b>Typical product: SSM3K15FU</b><br><br>Thickness: 0.9 typ.<br>Unit: mm      |
| <b>UFM</b><br>Ultra-super-Mini Flat lead<br><b>Typical product: SSM3J130TU</b><br><br>Thickness: 0.7 typ.<br>Unit: mm                  | <b>S-Mini (SOT-346)(SC-59)</b><br>Super-Mini<br><b>Typical product: SSM3K15F</b><br><br>Thickness: 1.1 typ.<br>Unit: mm                          | <b>TSM</b><br>Thin Super-Mini<br><b>Typical product: SSM3J304T</b><br><br>Thickness: 0.7 typ.<br>Unit: mm                     | <b>CST4</b><br>Chip-Scale Package, Transfer Molded, 4-Pin<br><b>Typical product: SSM4K27CT</b><br><br>Thickness: 0.38 typ.<br>Unit: mm             | <b>ESV (SOT-553)</b><br>Extreme Super-mini, 5-pin<br><b>Typical product: SSM5N15FE</b><br><br>Thickness: 0.55 typ.<br>Unit: mm   |
| <b>USV (SOT-353)(SC-88A)</b><br>Ultra-Super-mini, 5-pin<br><b>Typical product: SSM5N15FU</b><br><br>Thickness: 0.9 typ.<br>Unit: mm  | <b>UFV</b><br>Ultra-super-mini, Flat lead, 5-pin<br><b>Typical product: SSM5H12TU</b><br><br>Thickness: 0.7 typ.<br>Unit: mm                   | <b>SMV (SOT-25)(SC-74A)</b><br>Super-Mini, 5-pin<br><b>Typical product: SSM5H14F</b><br><br>Thickness: 1.1 typ.<br>Unit: mm | <b>CST6D</b><br>Chip-Scale Package, Transfer Molded, 6-Pin, D-Type<br><b>Typical product: SSM6N37CTD</b><br><br>Thickness: 0.38 typ.<br>Unit: mm | <b>ES6 (SOT-563)</b><br>Extreme Super-mini, 6-pin<br><b>Typical product: SSM6N36FE</b><br><br>Thickness: 0.55 typ.<br>Unit: mm |
| <b>US6 (SOT-353)(SC-88A)</b><br>Ultra-Super-mini, 6-pin<br><b>Typical product: SSM6N15FU</b><br><br>Thickness: 0.9 typ.<br>Unit: mm  | <b>UF6</b><br>Ultra Super mini Flat lead 6-pin<br><b>Typical product: SSM6J409TU</b><br><br>Thickness: 0.7 typ.<br>Unit: mm                    |  |  |   |

### TPC Series

The TPC Series comes in small, thin packages suitable for portable devices. The latest TSON Advance package allows the maximum permissible power dissipation equivalent to SOP-8, but occupies 64% less board space.

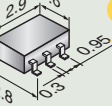
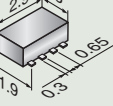
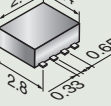
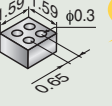
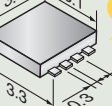
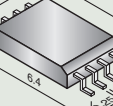
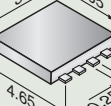
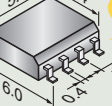
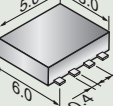
|   |   |   |  |  |
|---|---|---|--|--|
| <b>VS-6</b><br>Very Thin & Small, 6-pin<br><b>Typical product: TPC6003</b><br><br>Thickness: 0.75 typ.<br>Unit: mm | <b>VS-8</b><br>Very Thin & Small, 8-pin<br><b>Typical product: TPCF8101</b><br><br>Thickness: 0.8 typ.<br>Unit: mm | <b>PS-8</b><br>Progressive & Small 8-pin Series<br><b>Typical product: TPCP8402</b><br><br>Thickness: 0.8 typ.<br>Unit: mm | <b>Chip LGA</b><br>Land Grid Array<br><b>Typical product: TPCL4201</b><br><br>Thickness: 0.25 typ.<br>Unit: mm | <b>STP2</b><br>Small Thin Package<br><b>Typical product: TPCT4204</b><br><br>Thickness: 0.65 typ.<br>Unit: mm |
| <b>TSON Advance</b><br><b>Typical product: TPCC8005-H</b><br><br>Thickness: 0.85 typ.<br>Unit: mm                  | <b>TSSOP-8</b><br><b>Typical product: TPCS8208</b><br><br>Thickness: 0.9 typ.<br>Unit: mm                          | <b>TSSOP Advance</b><br><b>Typical product: TPCM8001-H</b><br><br>Thickness: 0.75 typ.<br>Unit: mm                         | <b>SOP-8</b><br><b>Typical product: TPC8035-H</b><br><br>Thickness: 1.6 typ.<br>Unit: mm                       | <b>SOP Advance</b><br><b>Typical product: TPCA8028-H</b><br><br>Thickness: 0.95 typ.<br>Unit: mm              |

## 4-2 Application Examples and Block Diagrams

### Cell Phone (Power Supply Circuit)

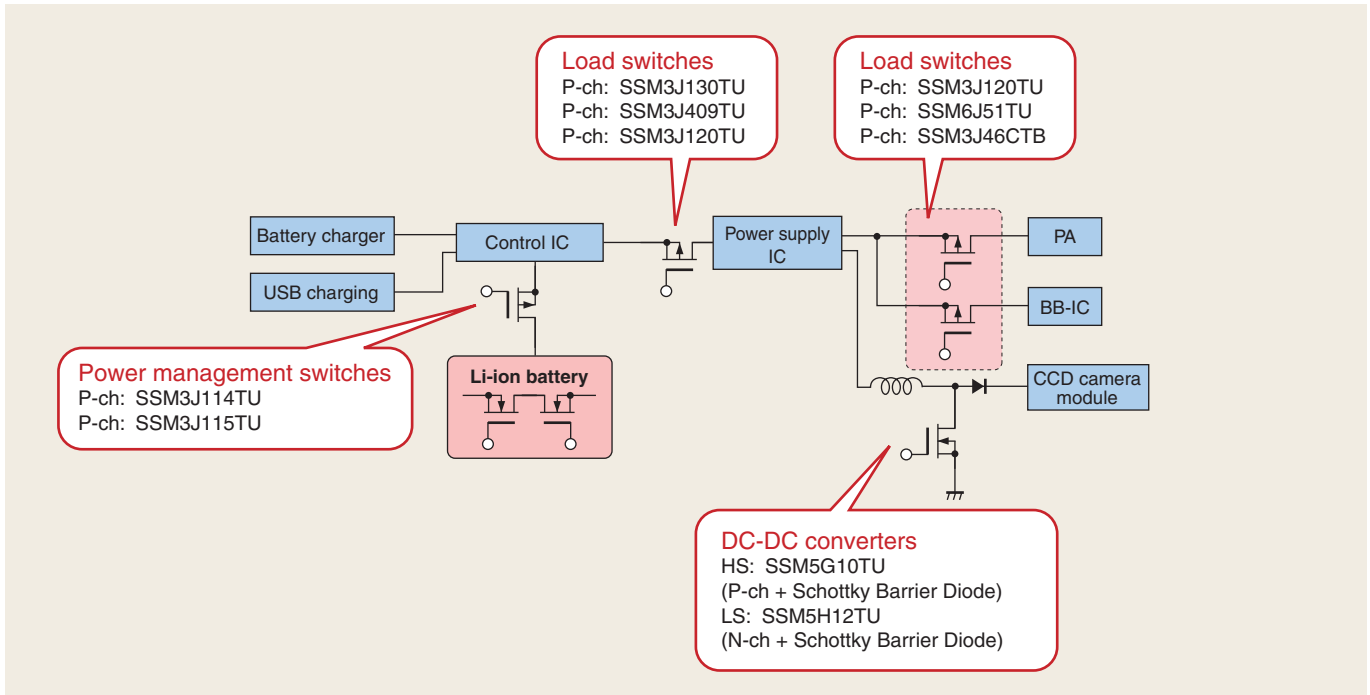

### Notebook PC (Power Supply Circuit)

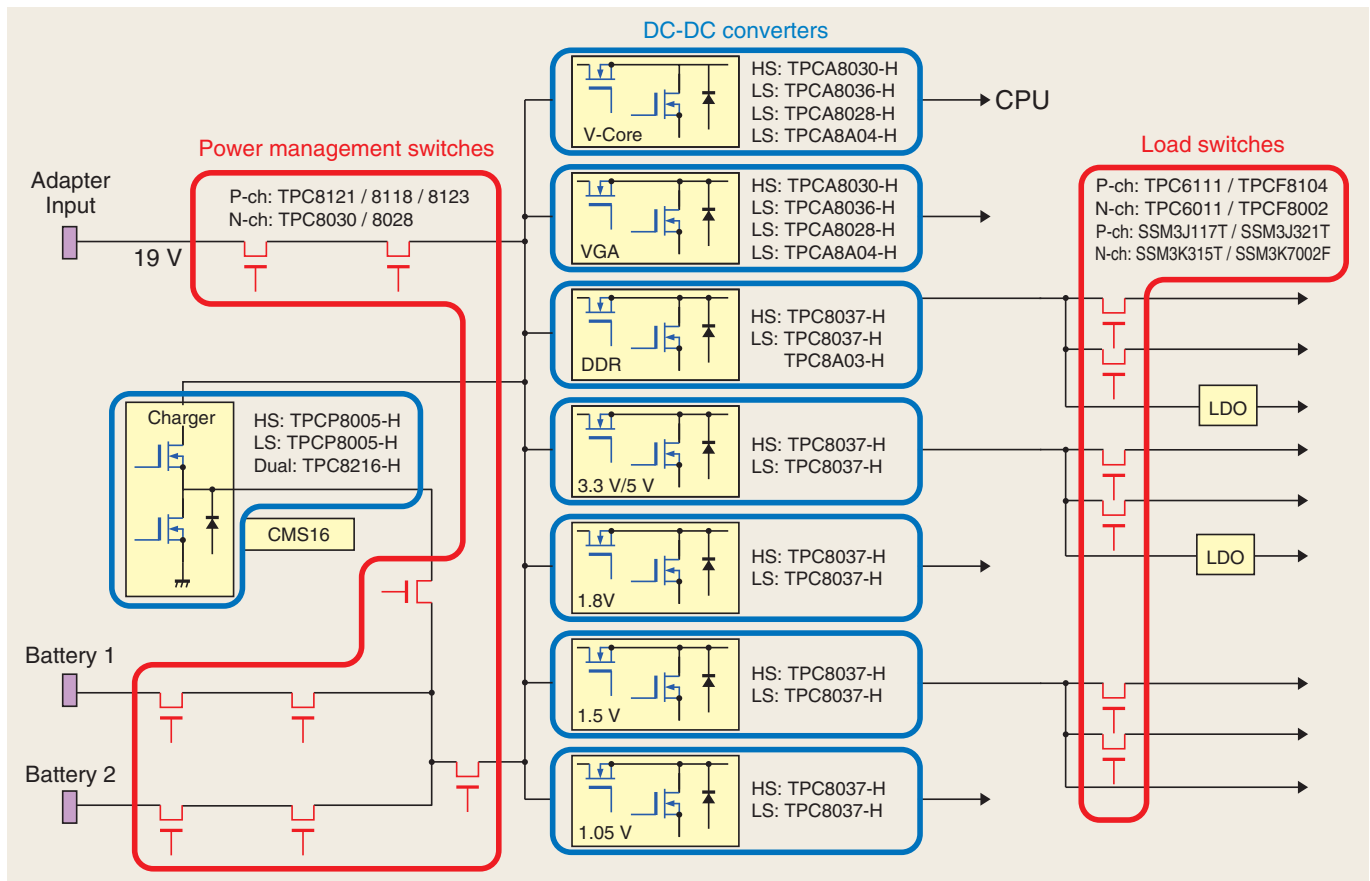

## 4-2 Application Examples and Block Diagrams

### Lithium-Ion Secondary Battery (Battery Protection Circuits)

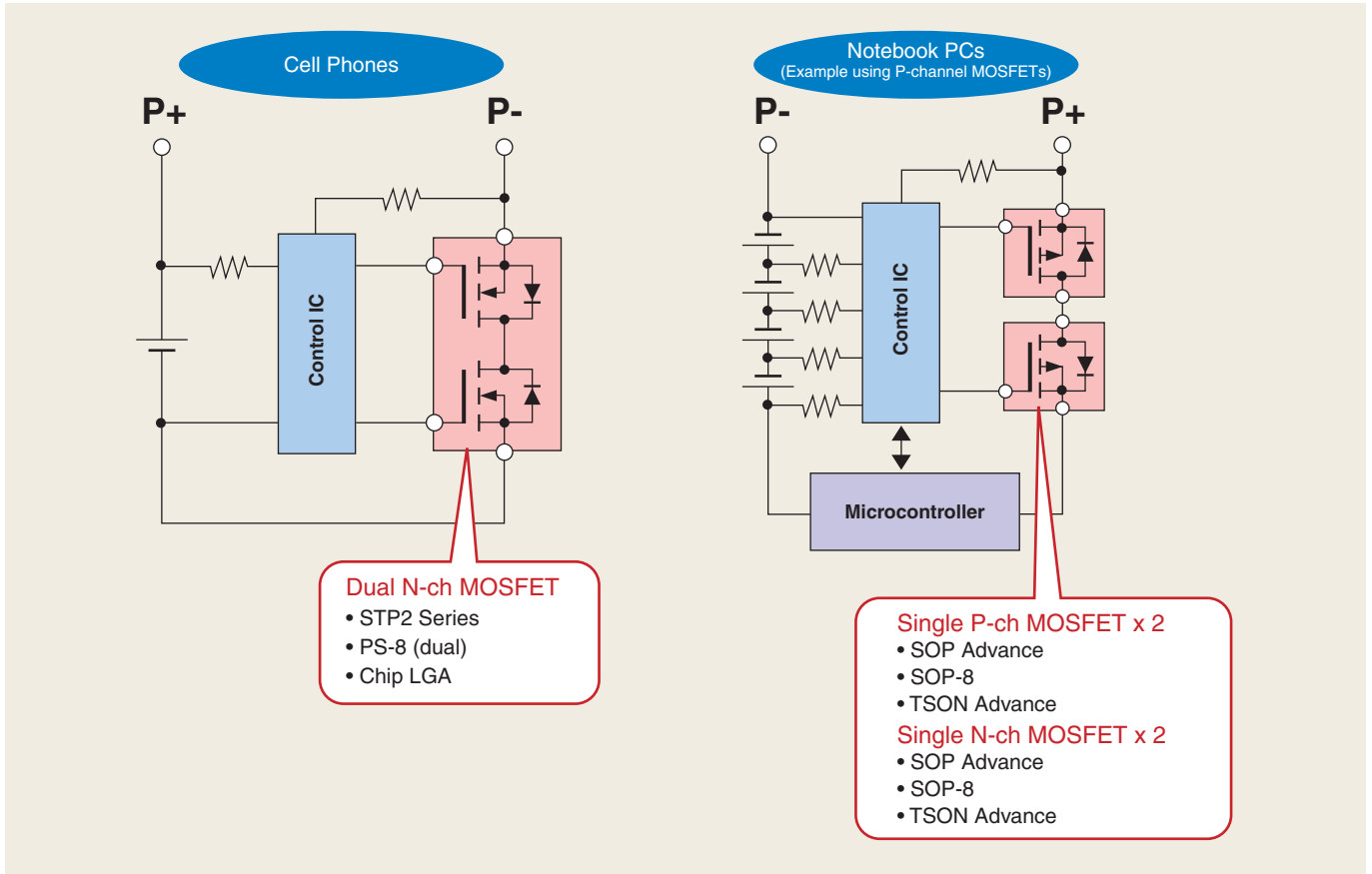

### Motor Driver (Power Driver Circuit)

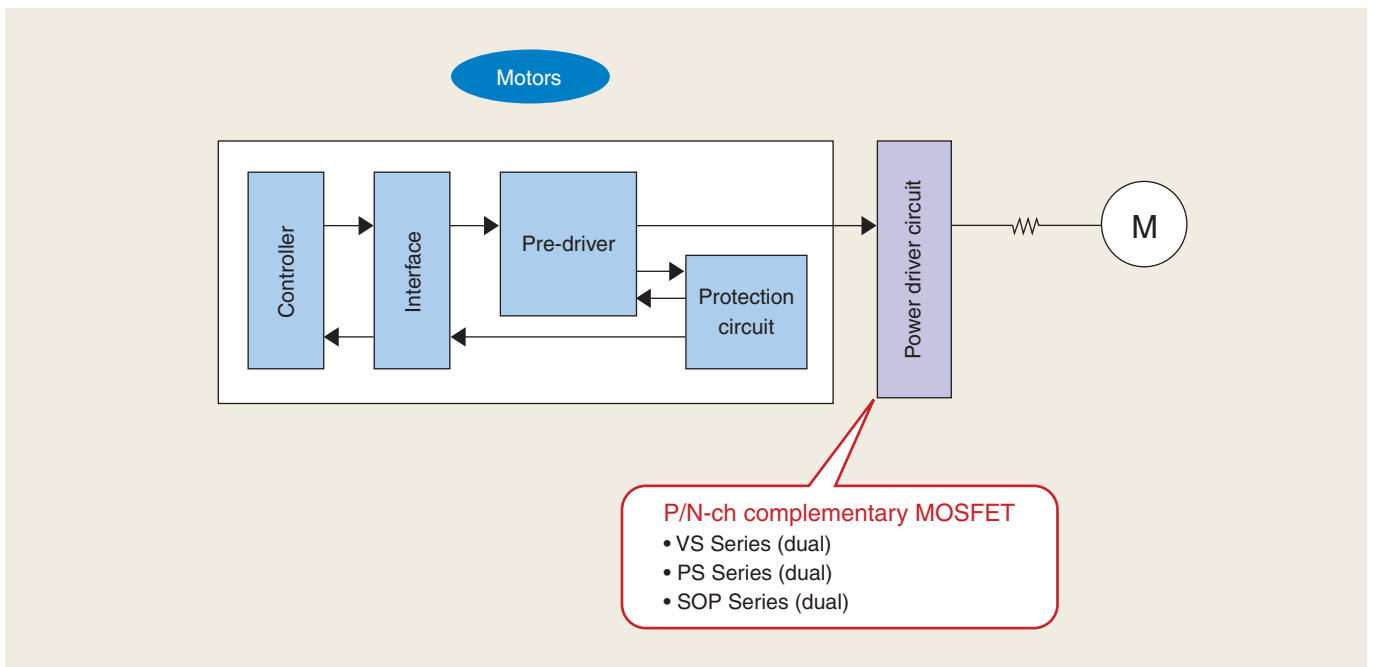

## 4-3 Low- $V_{DSS}$ MOSFET Roadmaps

### Roadmap for Trench MOSFETs

■ High-Speed, Low- $V_{DSS}$  U-MOS

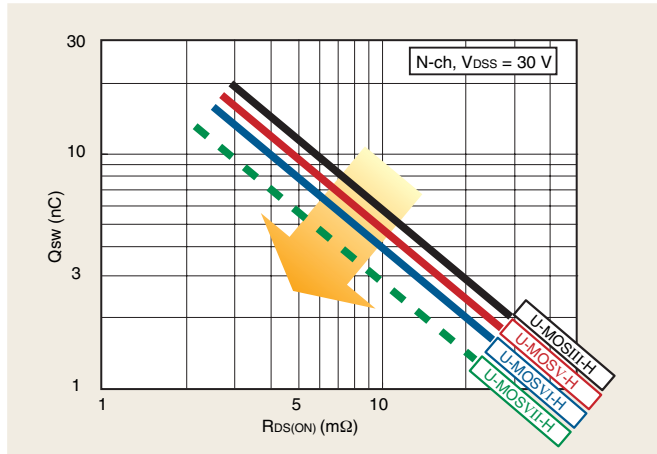

■ Low-Ron Trench MOSFETs

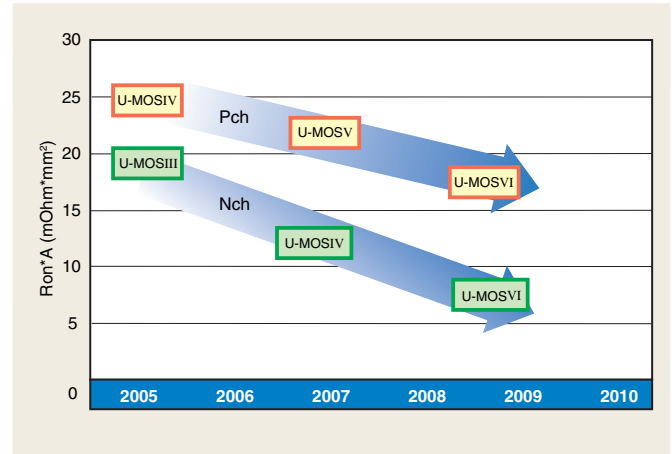

### Package Options

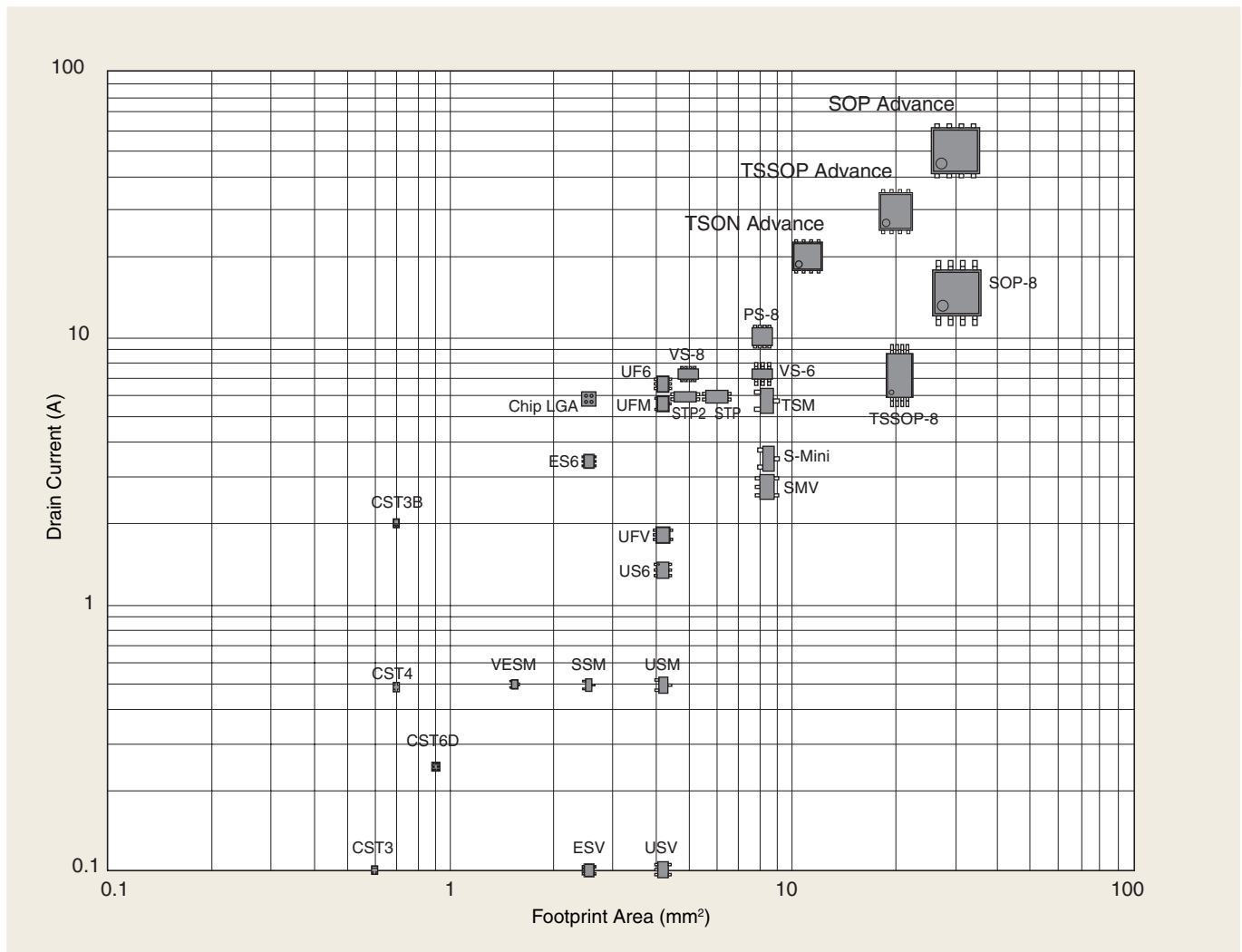

### Ultra-Small Packages

|                                      | S-Mini              | USM                 | SSM                 | VESM                | CST3                | US6                 | USV                 | ESV                 | CST6D               |
|--------------------------------------|---------------------|---------------------|---------------------|---------------------|---------------------|---------------------|---------------------|---------------------|---------------------|
|                                      |                     |                     |                     |                     |                     |                     |                     |                     |                     |
| Footprint Area                       | 7.3 mm <sup>2</sup> | 4.2 mm <sup>2</sup> | 2.6 mm <sup>2</sup> | 1.4 mm <sup>2</sup> | 0.6 mm <sup>2</sup> | 4.2 mm <sup>2</sup> | 4.2 mm <sup>2</sup> | 2.6 mm <sup>2</sup> | 0.9 mm <sup>2</sup> |
| Permissible Power Dissipation (Note) | 0.2 W               | 0.2 W               | 0.1 W               | 0.15 W              | 0.1 W               | 0.2 W               | 0.2 W               | 0.15 W              | 0.14 W              |
| Height (MAX)                         | 1.4 mm              | 1.1 mm              | 0.9 mm              | 0.55 mm             | 0.4 mm              | 1.1 mm              | 1.1 mm              | 0.6 mm              | 0.4 mm              |

Note: Mounted on FR4 Board (25.4 x 25.4 mm)

### Thermally-Enhanced Compact Packages

|                                      | TSM                 | UF6                 | SMV                 | UFV                 | UFM                 | ES6                 | CST3B               | CST4                |
|--------------------------------------|---------------------|---------------------|---------------------|---------------------|---------------------|---------------------|---------------------|---------------------|
|                                      |                     |                     |                     |                     |                     |                     |                     |                     |
| Footprint Area                       | 8.1 mm <sup>2</sup> | 4.2 mm <sup>2</sup> | 8.1 mm <sup>2</sup> | 4.2 mm <sup>2</sup> | 4.2 mm <sup>2</sup> | 2.6 mm <sup>2</sup> | 1.0 mm <sup>2</sup> | 1.0 mm <sup>2</sup> |
| Permissible Power Dissipation (Note) | 0.7 W               | 0.5 W               | 0.75 W              | 0.5 W               | 0.5 W               | 0.5 W               | 1.0 W               | 0.4 W               |
| Height (MAX)                         | 0.85 mm             | 0.75 mm             | 1.4 mm              | 0.75 mm             | 0.75 mm             | 0.6 mm              | 0.5 mm              | 0.4 mm              |

Note: Mounted on FR4 Board (25.4 x 25.4 mm)

### Thermally Enhanced Packages

|                               | SOP Adv.           | SOP-8              | TSSOP Adv.                  | TSON Adv.                   |
|-------------------------------|--------------------|--------------------|-----------------------------|-----------------------------|
|                               |                    |                    |                             |                             |
| Footprint Area                | 30 mm <sup>2</sup> | 30 mm <sup>2</sup> | 16.3 mm <sup>2</sup> (-46%) | 10.9 mm <sup>2</sup> (-64%) |
| Permissible Power Dissipation | 2.8 W (+47%)       | 1.9 W              | 2.3 W (+21%)                | 1.9 W                       |
| Height                        | 1.0 mm (-47%)      | 1.9 mm             | 0.8 mm (-58%)               | 0.9 mm (-53%)               |

(Percentage relative to SOP-8)

### Compact Packages

|                               | VS-8                       | VS-6                | PS-8                | Chip LGA                    |
|-------------------------------|----------------------------|---------------------|---------------------|-----------------------------|
|                               |                            |                     |                     |                             |
| Footprint Area                | 5.5 mm <sup>2</sup> (-32%) | 8.1 mm <sup>2</sup> | 8.1 mm <sup>2</sup> | 2.56 mm <sup>2</sup> (-68%) |
| Permissible Power Dissipation | 2.5 W (+14%)               | 2.2 W               | 1.68 W (-24%)       | —                           |
| Height                        | 0.85 mm                    | 0.85 mm             | 0.85 mm             | 0.25 mm (-71%)              |

(Percentage relative to VS-6)

## 4-4 Low- $V_{DS}$ , High-Speed MOSFETs

### Synchronous Rectification DC-DC Converters – Block Diagram, Timing Chart and Power Loss Factors

#### Block Diagram



#### Timing Chart

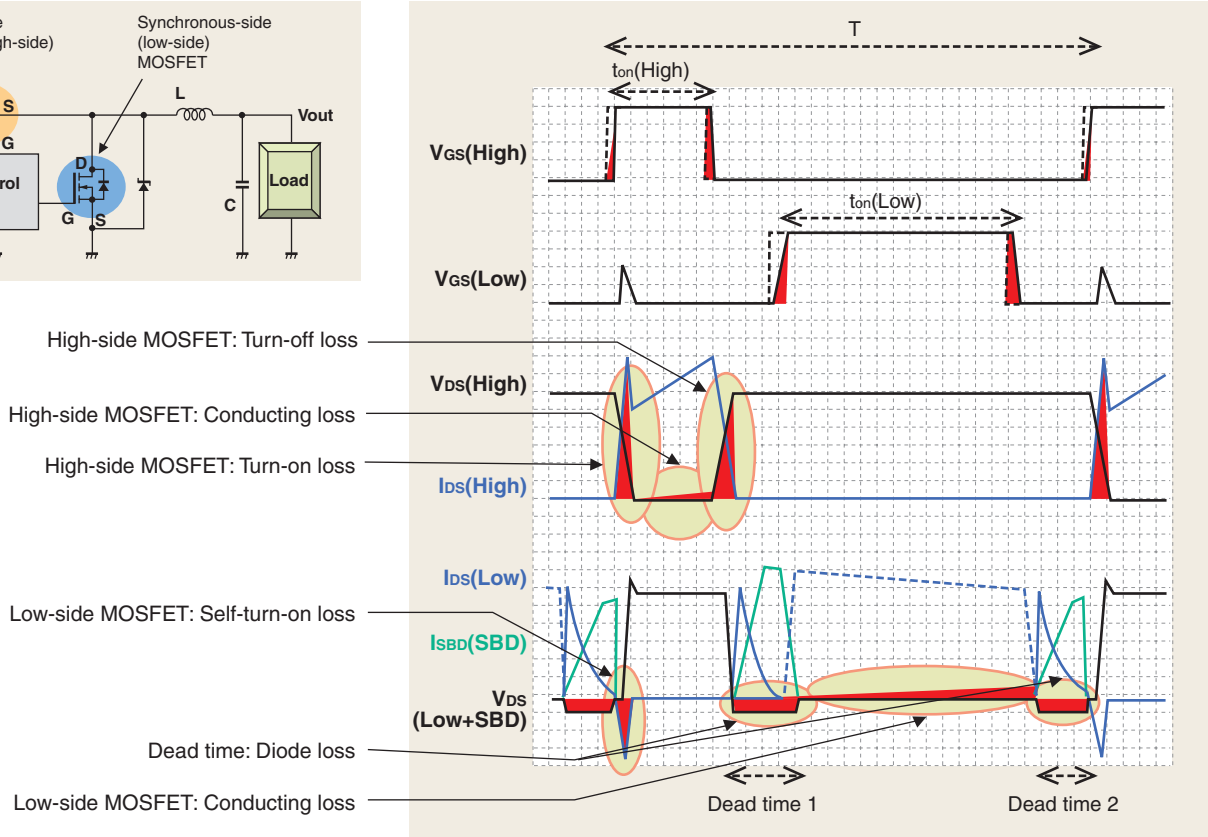

### Synchronous Rectification DC-DC Converters – Summary Results of Power Loss Simulation and Key Parameters for MOSFETs

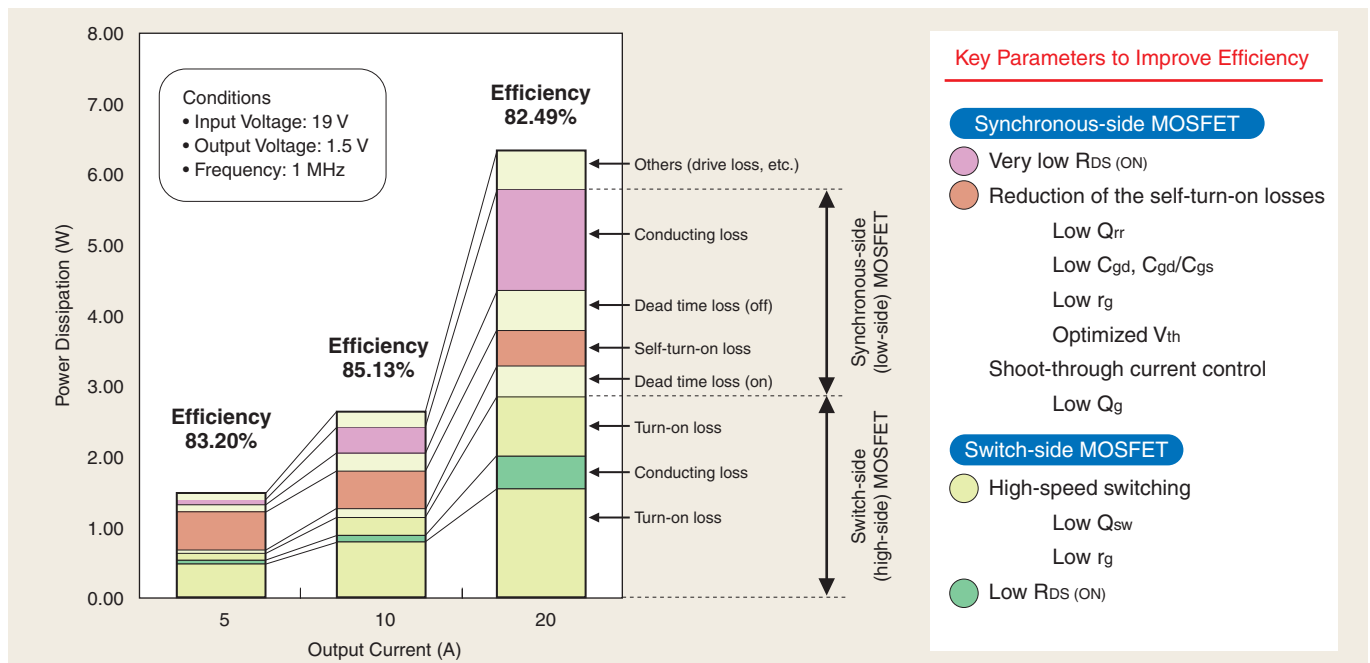

## Synchronous Rectification DC-DC Converters – Efficiency Improvement by Thermally Enhanced Package and New Process Technology

### Thermally Enhanced Package

Toshiba has developed the SOP Advance package with the same footprint area as the standard SOP-8 package. With an external heatsink on the bottom, the SOP Advance package offers enhanced thermal characteristics, realizing a high power dissipation and thus high-current capability.

Unit: mm

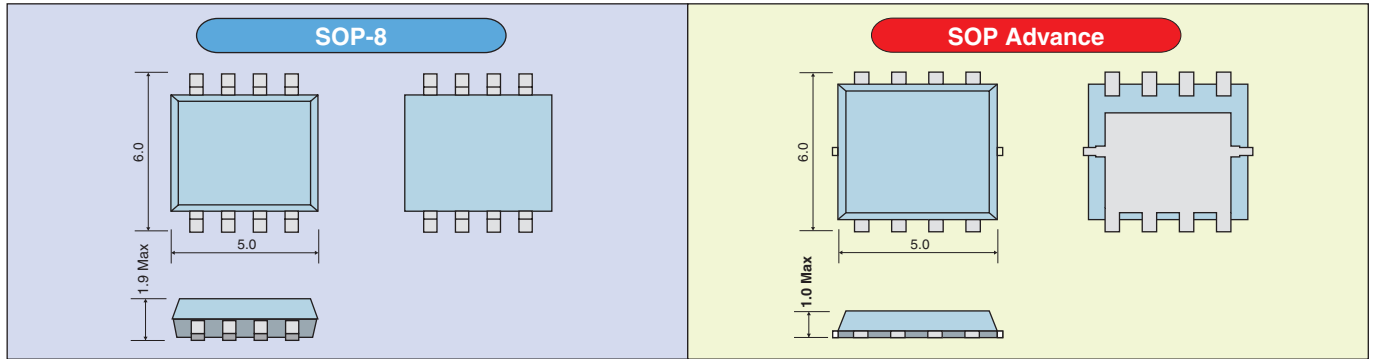

|  |                    | SOP-8 | SOP Advance | Features of the SOP Advance      |
|--|--------------------|-------|-------------|----------------------------------|
| Footprint Area                                   | (mm <sup>2</sup> ) | 30    | 30          | Same footprint area as the SOP-8 |
| Total height (max)                               | (mm)               | 1.9   | 1.0         | Low profile, Thinner by 0.9 mm   |
| $R_{th}(ch-a)$ ( $t = 10$ s) <sup>(Note 1)</sup> | (°C / W)           | 65.8  | 44.6        | High power dissipation           |
| Current rating                                   | (A)                | 18    | 40          | High current-carrying capacity   |
| Package resistance <sup>(Note 2)</sup>           | (mΩ)               | 1.6   | 0.5         | Low package resistance           |

Note 1: When mounted on a glass-epoxy board (25.4 mm x 25.4 mm x 0.8 mm)    Note 2: Without chip resistance

### New Process Technology

Toshiba has developed a new process technology to further reduce an internal gate resistance ( $r_g$ ) and gate capacitance ratio ( $C_{gd}/C_{gs}$ ) for minimizing the self-turn-on loss while maintaining both the low ON-resistance and low gate charge characteristics.

|                             | $R_{DS(ON)}$ Typ. @4.5 V (mΩ) | $r_g$ Typ. (Ω) | $C_{gd}/C_{gs}$ Typ. (%) |
|-----------------------------|-------------------------------|----------------|--------------------------|
| TPCA8028-H (New generation) | 2.3                           | 1.0            | 6.8                      |
| TPCA8019-H (One gen. ago)   | 3.1                           | 1.0            | 6.6                      |
| TPCA8004-H (Two gen. ago)   | 4.8                           | 2.4            | 12.7                     |

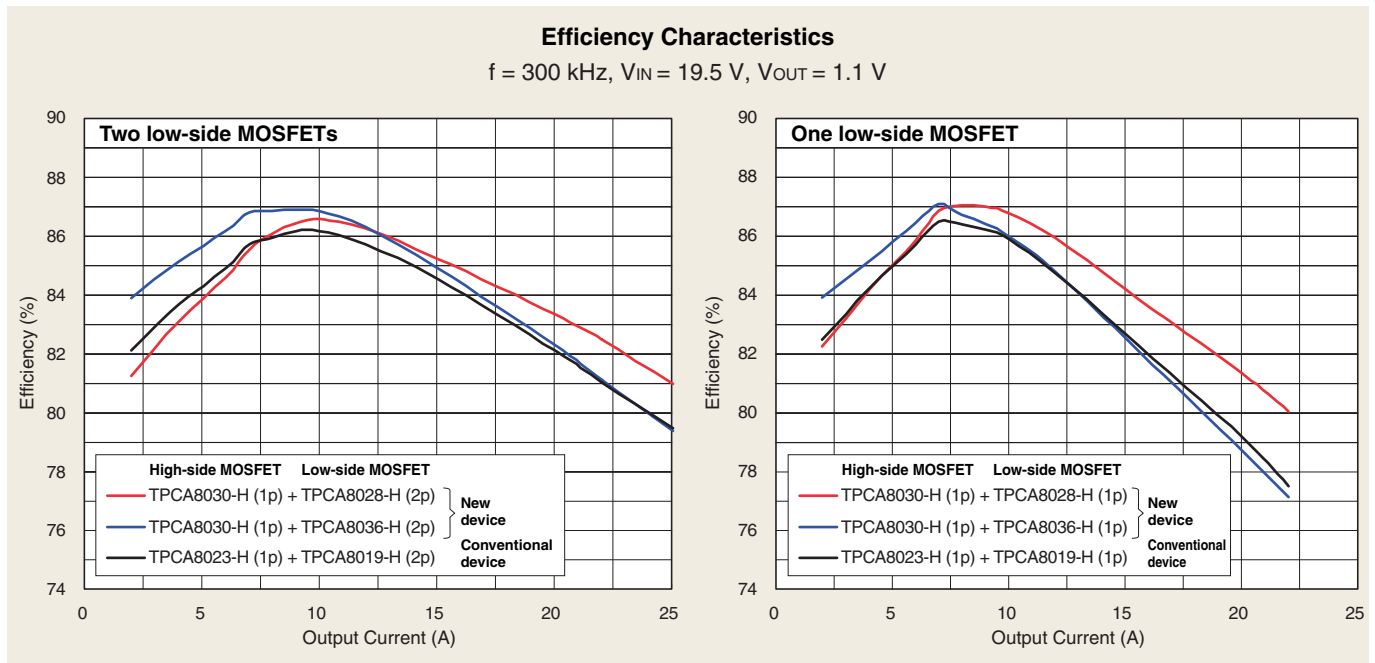

## Synchronous Rectification DC-DC Converters – MOSBD (MOSFET with SBD)

### External SBD

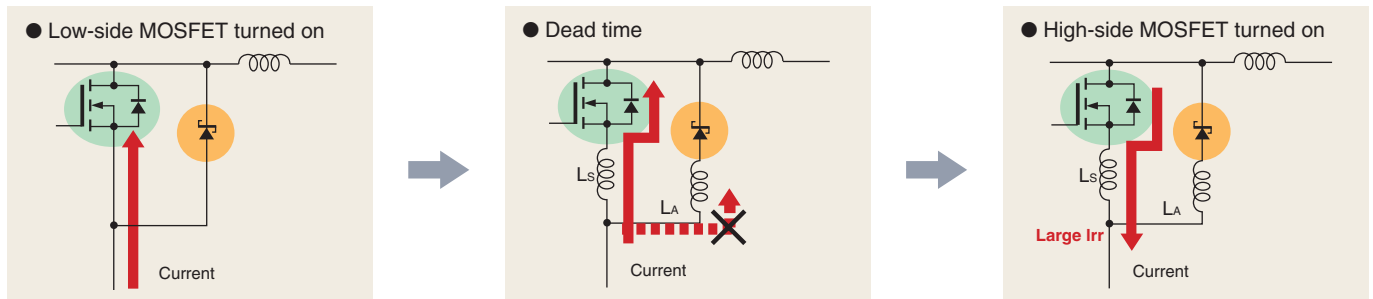

When an SBD is added externally, the SBD can't function fully due to the influence of wire inductances ( $L_s$  and  $L_A$ ); thus a body diode current during the dead time becomes larger and causes the following penalties.

- 1: Increase in the conducting loss of the body diode.
- 2: Increase in the reverse recovery loss due to high  $di/dt$ .
- 3: Induces a self-turn-on phenomenon.

### MOSFET with SBD (MOSBD)

A MOSFET with SBD using a monolithic structure reduces a wire inductance ( $L_A$ ) and a parasitic inductance ( $L_s$ ). This structure makes it possible for the SBD to function fully and to reduce losses.

#### Current Waveform Simulation

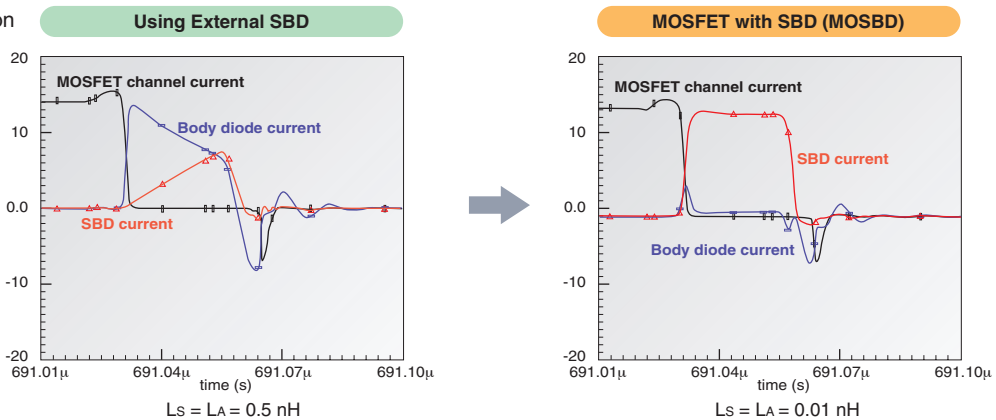

### Efficiency Characteristics

$f = 300 \text{ kHz}$ ,  $V_{IN} = 19.5 \text{ V}$ ,  $V_{OUT} = 1.1 \text{ V}$

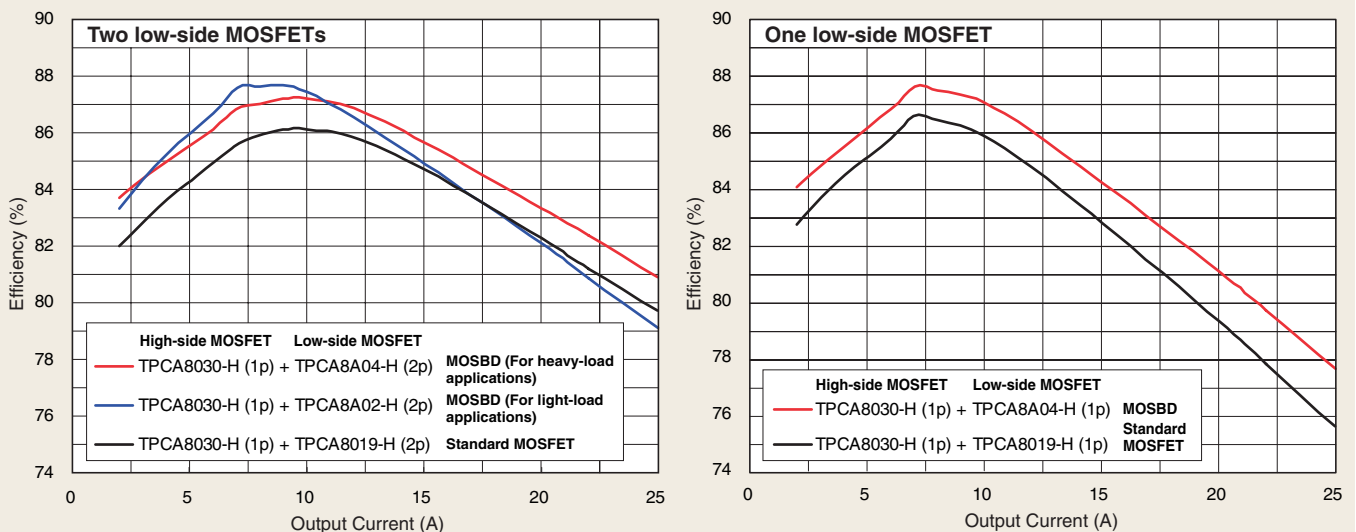

## High-Speed MOSFET Offerings

| Part Number  | Absolute Maximum Ratings |               |           | Circuit Configuration | Package      | $R_{DS(ON)}$ Max (m $\Omega$ ) |             |      | Qsw Typ.(nC)<br>@ $V_{DS} = V_{DSS} \times 0.8$ | Series     |            |
|--------------|--------------------------|---------------|-----------|-----------------------|--------------|--------------------------------|-------------|------|---|------------|------------|
|              | $V_{DSS}$ (V)            | $V_{GSS}$ (V) | $I_D$ (A) |                       |              | 2.5 V                          | 4.5 V       | 10 V |   |            |            |
| TPCA8011-H   | 20                       | $\pm 12$      | 40        | N-ch Single           | SOP Advance  | 7.5                            | 3.5         | —    | 16  | U-MOSIII-H |            |
| TPC6007-H    | 30                       |               | 5         |                       | VS-6         | —                              | 79          | 54   | 1.8   | U-MOSIII-H |            |
| TPC6109-H    | -30                      |               | -5        | P-ch Single           |              | —                              | 83          | 59   | 4.8   | U-MOSIII-H |            |
| TPC8216-H ☆  |                          |               | 6.4       | N-ch Dual             | SOP-8        | —                              | 23.0        | 20   | 3.4   | U-MOSVI-H  |            |
| TPCP8005-H ☆ |                          |               | 11        | N-ch Single           | PS-8         | —                              | 15.7        | 12.9 | 5.0   | U-MOSV-H   |            |
| TPCC8003-H ☆ |                          |               | 13        |                       | TSON Advance | —                              | 19.3        | 16.9 | 4.2   | U-MOSVI-H  |            |
| TPCC8001-H ☆ |                          |               | 22        |                       |              | —                              | 10.6        | 8.3  | 7.1   | U-MOSV-H   |            |
| TPCC8002-H ☆ |                          |               | 22        |                       |              | —                              | 10.6        | 8.3  | 7.1   | U-MOSV-H   |            |
| TPCC8006-H ☆ |                          |               | 22        |                       |              | —                              | 9.3         | 8.0  | 7.4   | U-MOSVI-H  |            |
| TPCC8005-H ☆ |                          |               | 26        |                       |              | —                              | 7.4         | 6.4  | 9.1   | U-MOSVI-H  |            |
| TPCM8003-H ☆ |                          |               | 21        |                       |              | TSSOP Advance                  | —           | 15.7 | 12.9  | 5.0        | U-MOSV-H   |
| TPCM8004-H ☆ |                          |               | 24        |                       | —            |                                | 13.4        | 11   | 5   | U-MOSV-H   |            |
| TPCM8002-H ☆ |                          |               | 30        |                       | —            |                                | 8.2         | 6.2  | 9.3   | U-MOSV-H   |            |
| TPC8021-H    |                          |               | 11        |                       | SOP-8        |                                | —           | 25   | 17  | 3.6        | U-MOSIII-H |
| TPC8031-H ☆  |                          |               | 11        |                       |              | —                              | 16.1        | 13.3 | 5.0   | U-MOSV-H   |            |
| TPC8037-H ☆  |                          |               | 12        |                       |              | —                              | 13.9        | 11.4 | 5   | U-MOSV-H   |            |
| TPC8038-H ☆  |                          |               | 12        |                       |              | —                              | 13.9        | 11.4 | 5   | U-MOSV-H   |            |
| TPC8040-H ☆  |                          |               | 13        |                       |              | —                              | 11.1        | 9.7  | 5.1   | U-MOSVI-H  |            |
| TPC8032-H ☆  | 30                       |               | 15        | —                     |              | 8.6                            | 6.5         | 8.4  | U-MOSV-H  |            |            |
| TPC8033-H ☆  |                          |               | 17        | —                     |              | 7.2                            | 5.3         | 9.6  | U-MOSV-H  |            |            |
| TPC8039-H ☆  |                          |               | 17        | —                     |              | 6.9                            | 6.0         | 8.5  | U-MOSVI-H                                       |            |            |
| TPC8034-H ☆  |                          |               | 18        | —                     |              | 4.5                            | 3.5         | 16   | U-MOSV-H  |            |            |
| TPC8036-H ☆  |                          |               | 18        | —                     |              | 5.1                            | 4.5         | 13   | U-MOSVI-H                                       |            |            |
| TPC8035-H ☆  |                          |               | 18        | —                     |              | 3.6                            | 3.2         | 17   | U-MOSVI-H                                       |            |            |
| TPCA8023-H ☆ |                          | $\pm 20$      | 21        | N-ch Single           |              | SOP Advance                    | —           | 15.7 | 12.9  | 5.0        | U-MOSV-H   |
| TPCA8040-H ☆ |                          |               | 23        |                       |              |                                | —           | 10.8 | 9.4   | 5.7        | U-MOSVI-H  |
| TPCA8030-H ☆ |                          |               | 24        |                       |              |                                | —           | 13.4 | 11.0  | 5          | U-MOSV-H   |
| TPCA8031-H ☆ |                          |               | 24        |                       |              |                                | —           | 13.4 | 11.0  | 5          | U-MOSV-H   |
| TPCA8018-H ☆ |                          |               | 30        |                       |              |                                | —           | 8.2  | 6.2   | 9.3        | U-MOSV-H   |
| TPCA8039-H ☆ |                          |               | 34        |                       |              |                                | —           | 6.6  | 5.7   | 8.6        | U-MOSVI-H  |
| TPCA8036-H ☆ |                          |               | 38        |                       |              |                                | —           | 4.8  | 4.2   | 13         | U-MOSVI-H  |
| TPCA8012-H ☆ |                          |               | 40        |                       | —            |                                | 6.8         | 4.9  | 11.0  | U-MOSV-H   |            |
| TPCA8060-H ☆ |                          |               | 45        |                       | —            |                                | 3.9         | 3.4  | 17  | U-MOSVI-H  |            |
| TPCA8019-H ☆ |                          |               | 45        |                       | —            |                                | 4.1         | 3.1  | 15.5  | U-MOSV-H   |            |
| TPCA8028-H ☆ |                          |               | 50        |                       | —            |                                | 3.2         | 2.8  | 20  | U-MOSVI-H  |            |
| TPC6006-H    |                          |               | 3.9       |                       |              |                                | VS-6        | —    | 100   | 75         | 1.3        |
| TPC8022-H    |                          |               | 7.5       | N-ch Single           | SOP-8        | —                              | 35          | 27   | 3.5   | U-MOSIII-H |            |
| TPC8052-H ☆  |                          |               | 12        |                       |              | —                              | 13.3        | 11.5 | 6.6   | U-MOSVI-H  |            |
| TPC8047-H ☆  |                          |               | 16        |                       |              | —                              | 8.8         | 7.6  | 11  | U-MOSVI-H  |            |
| TPC8046-H ☆  |                          |               | 18        |                       |              | —                              | 6.6         | 5.7  | 15  | U-MOSVI-H  |            |
| TPC8045-H ☆  |                          |               | 18        |                       |              | —                              | 4.4         | 3.9  | 23  | U-MOSVI-H  |            |
| TPCA8020-H   |                          |               | 7.5       |                       |              | N-ch Single                    | SOP Advance | —    | 35  | 27         | 3.5        |
| TPCA8052-H ☆ | 40                       |               | 20        | —                     | 13.1         |                                |             | 11.3 | 6.6   | U-MOSVI-H  |            |
| TPCA8014-H   |                          |               | 30        | —                     | 14           |                                |             | 9    | 7.4   | U-MOSIII-H |            |
| TPCA8027-H   |                          |               | 30        | —                     | —            |                                |             | 10   | 8.1   | U-MOSIII-H |            |
| TPCA8047-H ☆ |                          |               | 32        | —                     | 8.5          |                                |             | 7.3  | 13  | U-MOSVI-H  |            |
| TPCA8015-H   |                          |               | 35        | —                     | 7.9          |                                |             | 5.4  | 13  | U-MOSIII-H |            |
| TPCA8046-H ☆ |                          |               | 38        | —                     | 6.3          |                                |             | 5.4  | 15  | U-MOSVI-H  |            |
| TPCA8045-H ☆ |                          |               | 46        | —                     | 4.1          |                                |             | 3.6  | 23  | U-MOSVI-H  |            |

☆: No protection Zener diode between gate and source

| Part Number  | Absolute Maximum Ratings |                      |                    | Circuit Configuration | Package     | R <sub>DS(ON)</sub> Max (mΩ) |            | Q <sub>sw</sub> Typ. (nC)<br>@ V <sub>DS</sub> =<br>V <sub>DS</sub> x 0.8 | Series     |           |
|--------------|--------------------------|----------------------|--------------------|-----------------------|-------------|------------------------------|------------|---|------------|-----------|
|              | V <sub>DSS</sub> (V)     | V <sub>GSS</sub> (V) | I <sub>D</sub> (A) |                       |             | 4.5 V                        | 10 V       |   |            |           |
| TPC8218-H ☆  | 60                       | ±20                  | 3.8                | N-ch Dual             | SOP-8       | 64                           | 57         | 2.6   | U-MOSVI-H  |           |
| TPC8213-H    |                          |                      | 5                  |                       |             | 56                           | 50         | 2.9   | U-MOSIII-H |           |
| TPC8053-H ☆  |                          |                      | 9                  | N-ch Single           |             | SOP Advance                  | 24.2       | 22.5  | 6.7        | U-MOSVI-H |
| TPC8050-H ☆  |                          |                      | 11                 |                       |             |                              | 15.6       | 14.5  | 9.2        | U-MOSVI-H |
| TPC8049-H ☆  |                          |                      | 13                 |                       |             |                              | 11.5       | 10.7  | 13         | U-MOSVI-H |
| TPC8048-H ☆  |                          |                      | 16                 |                       |             |                              | 7.4        | 6.9   | 17         | U-MOSVI-H |
| TPCA8053-H ☆ |                          |                      | 15                 |                       | 24          |                              | 22.3       | 6.9   | U-MOSVI-H  |           |
| TPCA8050-H ☆ |                          |                      | 24                 |                       | 15.3        |                              | 14.2       | 10  | U-MOSVI-H  |           |
| TPCA8016-H   |                          |                      | 25                 |                       | 26          |                              | 21         | 6.6   | U-MOSIII-H |           |
| TPCA8049-H ☆ |                          |                      | 28                 |                       | 11.2        |                              | 10.4       | 13  | U-MOSVI-H  |           |
| TPCA8048-H ☆ |                          |                      | 35                 | 7.1                   | 6.6         | 19                           | U-MOSVI-H  |   |            |           |
| TPC8051-H ☆  |                          |                      | 80                 | 13                    | SOP-8       | 10.1                         | 9.7        | 16  | U-MOSVI-H  |           |
| TPCA8051-H ☆ |                          |                      |                    | 28                    | SOP Advance | 9.8                          | 9.4        | 18  | U-MOSVI-H  |           |
| TPCP8003-H   |                          |                      | 100                | 2.2                   | PS-8        | 190                          | 180        | 2.0   | U-MOSIII-H |           |
| TPC8214-H    | 2.2                      | N-ch Dual            |                    | SOP-8                 | 190         | 180                          | 2.0        | U-MOSIII-H  |            |           |
| TPCA8022-H   | 150                      | 22                   | SOP Advance        | —                     | 26          | 14                           | U-MOSIII-H |   |            |           |
| TPCA8009-H   |                          | 7                    | SOP Advance        | —                     | 350         | 3.7                          | π-MOSV     |   |            |           |
| TPCA8010-H   |                          | 200                  | 5.5                | SOP Advance           | —           | 450                          | 3.7        | π-MOSV  |            |           |
| TPCA8008-H   |                          | 250                  | 4                  | SOP Advance           | —           | 580                          | 3.7        | π-MOSV  |            |           |
| TPCP8A05-H ☆ |                          | 30                   | 8                  | PS-8                  | 21.9        | 17.5                         | 2.7        | U-MOSV-H  |            |           |
| TPCC8A01-H ☆ |                          |                      | 21                 | TSON Advance          | 12.6        | 9.9                          | 4.1        | U-MOSV-H  |            |           |
| TPCM8A05-H ☆ | 20                       |                      | TSSOP Advance      | 17.2                  | 12.9        | 3.7                          | U-MOSV-H   |   |            |           |
| TPC8A05-H ☆  | 10                       |                      | MOSBD              | SOP-8                 | 17.6        | 13.3                         | 3.7        | U-MOSV-H  |            |           |
| TPC8A06-H ☆  | 12                       |                      |                    |                       | 12.9        | 10.1                         | 4.5        | U-MOSV-H  |            |           |
| TPC8A03-H ☆  | 17                       |                      |                    |                       | 7.0         | 5.6                          | 8.4        | U-MOSV-H  |            |           |
| TPC8A04-H ☆  | 18                       |                      |                    |                       | 4.5         | 3.6                          | 13.4       | U-MOSV-H  |            |           |
| TPCA8A05-H ☆ | 20                       |                      |                    |                       | 17.2        | 12.9                         | 3.7        | U-MOSV-H  |            |           |
| TPCA8A02-H ☆ | 34                       |                      |                    |                       | SOP Advance | 6.7                          | 5.3        | 8.6   | U-MOSV-H   |           |
| TPCA8A08-H ☆ | 38                       |                      | 5.1                | 3.9                   |             | 11                           | U-MOSV-H   |   |            |           |
| TPCA8A04-H ☆ | 44                       | 4.1                  | 3.2                | 13.4                  |             | U-MOSV-H                     |            |   |            |           |
| TPCP8103-H   | -40                      | -4.8                 | PS-8               | 54                    |             | 40                           | 6.5        | U-MOSIII-H  |            |           |
| TPC8116-H    |                          | -7.5                 | P-ch Single        | SOP-8                 | 37          | 30                           | 9.7        | U-MOSIII-H  |            |           |
| TPCA8107-H   |                          | -7.5                 | SOP Advance        | 37                    | 30          | 9.7                          | U-MOSIII-H |   |            |           |
| TPC8406-H    | 40                       | 6.5                  | N-ch/P-ch Dual     | SOP-8                 | 35          | 27                           | 3.5        | U-MOSIII-H  |            |           |
|              | -40                      | -6.5                 |                    |                       | 37          | 30                           | 9.7        | U-MOSIII-H  |            |           |

☆: No protection Zener diode between gate and source

## 4-5 Low- $V_{DSS}$ , Low- $R_{DS(ON)}$ MOSFETs (for Lithium-Ion Battery Protection)

### Lithium-Ion Battery Protection Circuit Trend

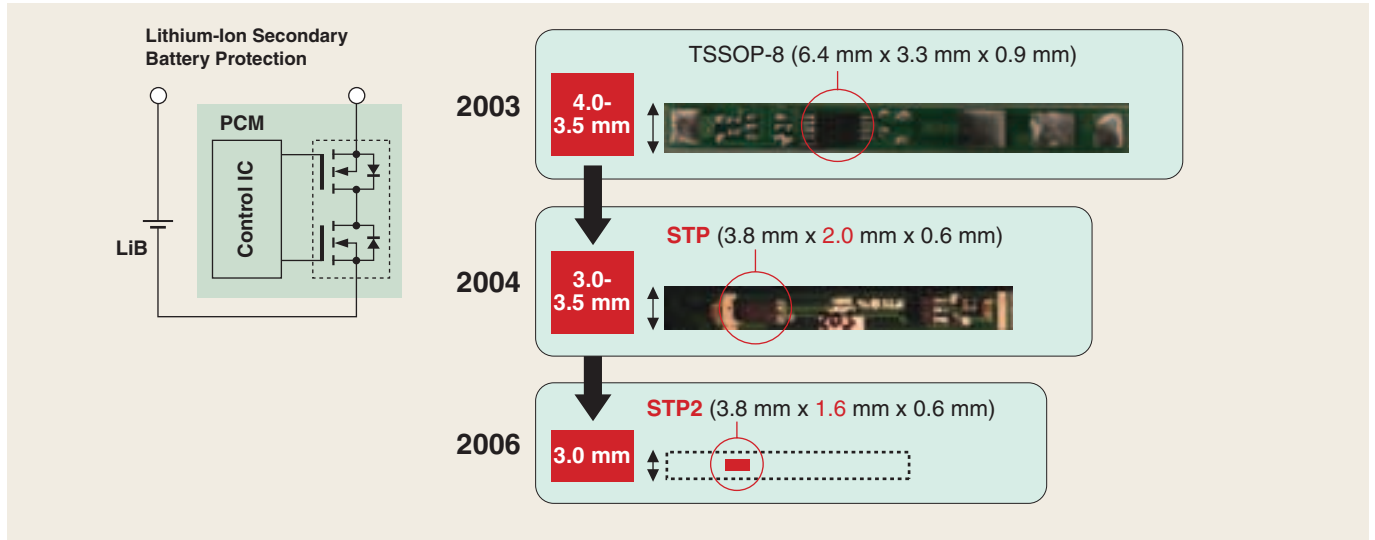

### MOSFET Roadmap

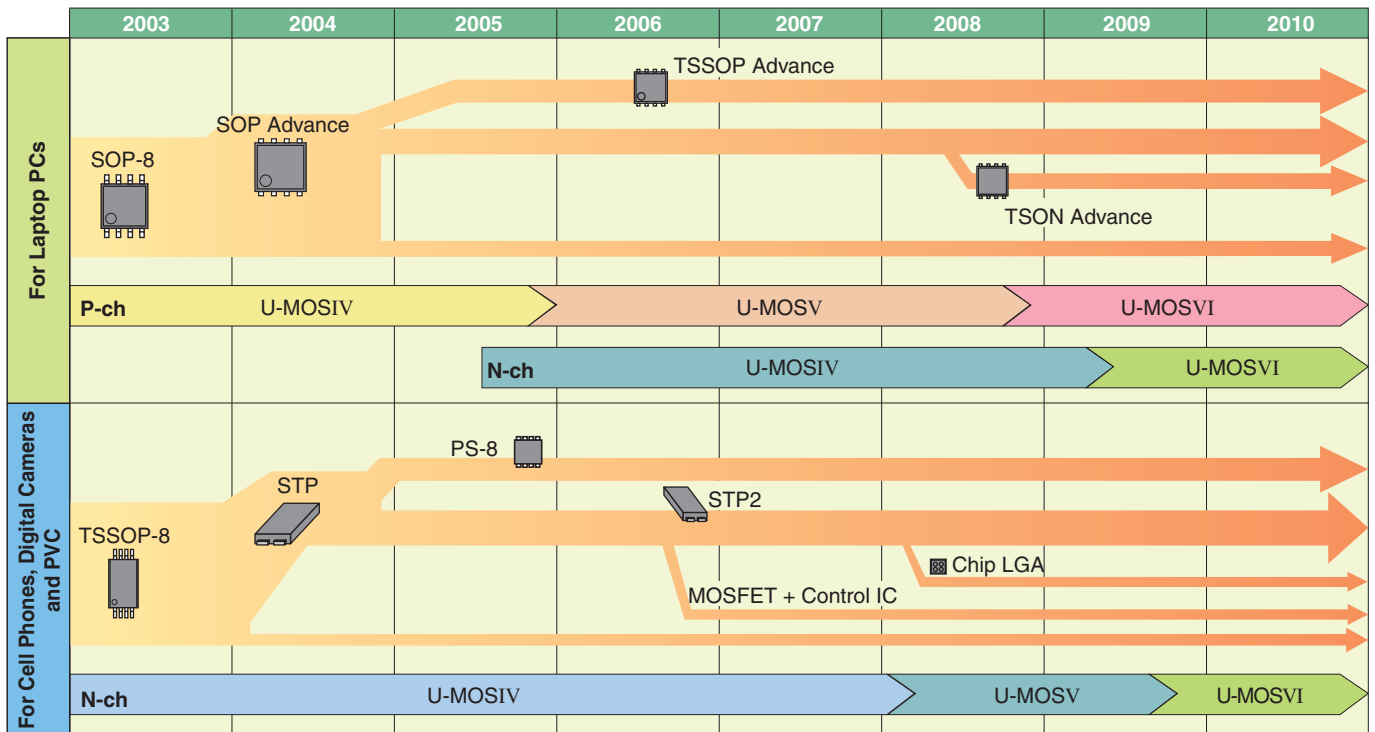

## Low-ON-resistance N-Channel Power MOSFETs

| Part Number | Absolute Maximum Ratings |                      |                    | Circuit Configuration | Package     | R <sub>DS(ON)</sub> Max (mΩ) |             |       |         | Series  |          |
|-------------|--------------------------|----------------------|--------------------|-----------------------|-------------|------------------------------|-------------|-------|---------|---------|----------|
|             | V <sub>bss</sub> (V)     | V <sub>gss</sub> (V) | I <sub>d</sub> (A) |                       |             | 2.5 V                        | 4 V         | 4.5 V | 10 V    |         |          |
| TPCT4203 ☆  | 20                       | ±12                  | 6                  | STP2                  | N-ch Dual   | 49                           | 32          | —     | —       | U-MOSIV |          |
| TPCT4204 ☆  | 30                       | ±12                  | 6                  |                       |             | 52                           | 39          | —     | —       | U-MOSIV |          |
| TPCL4201 ☆  | 20                       | ±12                  | 6                  | Chip LGA              |             | 52                           | —           | 31    | —       | U-MOSV  |          |
| TPCL4203 ☆* | 24                       | ±12                  | 6                  |                       |             | 55                           | —           | 36    | —       | U-MOSV  |          |
| TPCL4202 ☆* | 30                       | ±12                  | 6                  | PS-8                  | N-ch Single | 64                           | —           | 40    | —       | U-MOSV  |          |
| TPCP8006 ☆  | 20                       | ±12                  | 9.1                |                       |             | 13.7                         | —           | 10    | —       | U-MOSIV |          |
| TPCP8004 ☆  | 30                       | ±20                  | 8.3                |                       | —           | —                            | 14          | 8.5   | U-MOSIV |         |          |
| TPCP8202    | 30                       | ±12                  | 5.5                | TSON Advance          | N-ch Dual   | 39                           | 24          | 23    | —       | U-MOSIV |          |
| TPCC8007 ☆* | 20                       | ±12                  | 27                 |                       | (8.7)       | —                            | (4.6)       | —     | U-MOSIV |         |          |
| TPCC8008 ☆  | 30                       | ±25                  | 25                 | SOP-8                 | N-ch Single | —                            | —           | 12.8  | 6.8     | U-MOSIV |          |
| TPC8025 ☆   | 30                       | ±20                  | 11                 |                       |             | —                            | —           | 14.5  | 9       | U-MOSIV |          |
| TPC8030 ☆   | 30                       | ±25                  | 11                 |                       |             | —                            | —           | 17    | 9       | U-MOSIV |          |
| TPC8041 ☆   | 30                       | ±20                  | 13                 |                       |             | —                            | —           | 13.5  | 7       | U-MOSIV |          |
| TPC8026 ☆   | 30                       | ±20                  | 13                 |                       |             | —                            | —           | 10    | 6.6     | U-MOSIV |          |
| TPC8028 ☆   | 30                       | ±20                  | 18                 |                       |             | —                            | —           | 8     | 4.3     | U-MOSIV |          |
| TPC8029 ☆   | 30                       | ±20                  | 18                 |                       |             | —                            | —           | 7     | 3.8     | U-MOSIV |          |
| TPC8042 ☆   | 30                       | ±20                  | 18                 |                       |             | —                            | —           | 6.5   | 3.4     | U-MOSIV |          |
| TPC8027 ☆   | 30                       | ±20                  | 18                 |                       |             | —                            | —           | 5.5   | 2.7     | U-MOSIV |          |
| TPC8208     | 20                       | ±12                  | 5                  |                       |             | N-ch Dual                    | 70          | 50    | —       | —       | U-MOSIII |
| TPC8207     | 20                       | ±12                  | 6                  |                       |             |                              | 30          | 20    | —       | —       | U-MOSIII |
| TPC8211     | 30                       | ±20                  | 5.5                |                       |             |                              | —           | —     | 44      | 36      | U-MOSIII |
| TPC8210     | 30                       | ±20                  | 8                  |                       |             |                              | —           | —     | 20      | 15      | U-MOSIII |
| TPCA8024 ☆  | 30                       | ±20                  | 35                 |                       |             | SOP Advance                  | N-ch Single | —     | —       | 7.8     | 4.3      |
| TPCA8025 ☆  | 30                       | ±20                  | 40                 | —                     | —           |                              |             | 6.0   | 3.5     | U-MOSIV |          |
| TPCA8042 ☆  | 30                       | ±20                  | 45                 | —                     | —           |                              |             | 5.7   | 3.3     | U-MOSIV |          |
| TPCA8026 ☆  | 30                       | ±20                  | 45                 | —                     | —           |                              |             | 4.5   | 2.2     | U-MOSIV |          |

☆: No protection Zener diode between gate and source \* : Under development

## Low-ON-resistance P-Channel Power MOSFETs

| Part Number | Absolute Maximum Ratings |                      |                    | Circuit Configuration | Package     | R <sub>DS(ON)</sub> Max (mΩ) |      |       |         | Series  |
|-------------|--------------------------|----------------------|--------------------|-----------------------|-------------|------------------------------|------|-------|---------|---------|
|             | V <sub>bss</sub> (V)     | V <sub>gss</sub> (V) | I <sub>d</sub> (A) |                       |             | 2.5 V                        | 4 V  | 4.5 V | 10 V    |         |
| TPCC8102 ☆  | -30                      | ±20                  | -15                | TSON Advance          | P-ch Single | —                            | 33.2 | —     | 18.9    | U-MOSV  |
| TPCC8103 ☆  | -30                      | ±20                  | -18                |                       |             | —                            | 22   | —     | 12      | U-MOSV  |
| TPC8115     | -20                      | ±8                   | -10                | SOP-8                 |             | 14                           | —    | 10    | —       | U-MOSIV |
| TPC8119 ☆   | -30                      | ±20                  | -10                |                       |             | —                            | 28   | —     | 13      | U-MOSV  |
| TPC8121 ☆   | -30                      | ±20                  | -11                |                       |             | —                            | 24   | —     | 12      | U-MOSV  |
| TPC8111     | -30                      | ±20                  | -11                |                       |             | —                            | 18   | —     | 12      | U-MOSIV |
| TPC8113     | -30                      | ±20                  | -11                |                       |             | —                            | 18   | —     | 10      | U-MOSIV |
| TPC8123 ☆   | -30                      | -25/+20              | -11                |                       |             | —                            | —    | 12.5  | 9       | U-MOSVI |
| TPC8122 ☆   | -30                      | ±20                  | -12                |                       |             | —                            | 16.5 | —     | 8       | U-MOSV  |
| TPC8118 ☆   | -30                      | ±20                  | -13                |                       |             | —                            | 15   | —     | 7       | U-MOSV  |
| TPC8114     | -30                      | ±20                  | -18                |                       |             | —                            | 6.8  | —     | 4.5     | U-MOSIV |
| TPC8117 ☆   | -30                      | ±20                  | -18                |                       |             | —                            | 7.9  | —     | 3.9     | U-MOSV  |
| TPC8120 ☆   | -30                      | -25/+20              | -18                |                       |             | —                            | —    | 4.2   | 3.2     | U-MOSVI |
| TPC8405     | 30                       | ±20                  | 6                  |                       |             | N-ch/P-ch Dual               | —    | —     | 33      | 26      |
|             | -30                      | ±20                  | -4.5               | —                     | —           |                              | 42   | 33    | U-MOSIV |         |
| TPCM8102 ☆  | -30                      | ±20                  | -25                | TSSOP Advance         | P-ch Single | —                            | 16   | —     | 7.7     | U-MOSV  |
| TPCA8105    | -12                      | ±8                   | -6                 | SOP Advance           |             | 51                           | 33   | —     | —       | U-MOSIV |
| TPCA8103    | -30                      | ±20                  | -40                |                       |             | —                            | 6.8  | —     | 4.2     | U-MOSIV |
| TPCA8106 ☆  | -30                      | ±20                  | -40                |                       |             | —                            | 7.8  | —     | 3.7     | U-MOSV  |

☆: No protection Zener diode between gate and source

## 4-6 Semi-Power MOSFET Offerings

### Semi-Power P-Channel Single MOSFETs

Unit: mm

| Package                  | Part Number | $V_{DSS}$ (V) | $V_{GS}$ (V) | $I_D$ (A) | $R_{DS(ON)}$ Max (m $\Omega$ ) |                  |                  |                  | $C_{iss}$ (pF) | Series       | *Internal Connections | Land Pattern Example |
|--------------------------|-------------|---------------|--------------|-----------|--------------------------------|------------------|------------------|------------------|----------------|--------------|-----------------------|----------------------|
|                          |             |               |              |           | $V_{GS} = 1.5$ V               | $V_{GS} = 1.8$ V | $V_{GS} = 2.5$ V | $V_{GS} = 4.0$ V |                |              |                       |                      |
| <b>CST3B</b><br>         | SSM3J46CTB  | -20           | $\pm 8$      | -2.0      | 250                            | 178              | 133              | 103 (@4.5 V)     | 290            | U-MOSVI      |                       |                      |
| <b>ES6 (SOT-563)</b><br> | SSM6J212FE* | -20           | $\pm 8$      | -3.3      | 108                            | 73.7             | 45.6             | 43.4(@4.5V)      | 834            | U-MOSVI      |                       |                      |
|                          | SSM6J53FE   | -20           | $\pm 8$      | -1.8      | 364                            | 204              | 136              | —                | 568            | U-MOSIV      |                       |                      |
|                          | SSM6J206FE  | -20           | $\pm 8$      | -2.0      | —                              | 320              | 186              | 130              | 335            | U-MOSIII     |                       |                      |
|                          | SSM6J205FE  | -20           | $\pm 8$      | -0.8      | —                              | 460              | 306              | 234              | 250            | U-MOSIII     |                       |                      |
|                          | SSM6J26FE   | -20           | $\pm 8$      | -0.5      | —                              | 980              | 330              | 230              | 250            | U-MOSIII     |                       |                      |
|                          | SSM6J23FE   | -12           | $\pm 8$      | -1.2      | —                              | —                | 210              | 160              | 420            | U-MOSIII     |                       |                      |
|                          | SSM6J25FE   | -20           | $\pm 12$     | -0.5      | —                              | —                | 430              | 260              | 218            | U-MOSIII     |                       |                      |
| SSM6J207FE               | -30         | $\pm 20$      | -1.4         | —         | —                              | —                | 491              | 137              | U-MOSII        |              |                       |                      |
| <b>UFM</b><br>           | SSM3J132TU* | -12           | $\pm 5$      | -5.0      | 40.4                           | 28.3             | 21.7             | 17.8(@4.5V)      | 2700           | U-MOSVI      |                       |                      |
|                          | SSM3J130TU  | -20           | $\pm 8$      | -4.4      | 63.2                           | 41.1             | 31               | 25.8(@4.5V)      | 1800           | U-MOSVI      |                       |                      |
|                          | SSM3J120TU  | -20           | $\pm 8$      | -4.0      | 140                            | 78               | 49               | 38               | 1484           | U-MOSIV      |                       |                      |
|                          | SSM3J129TU  | -20           | $\pm 8$      | -4.6      | 137                            | 88               | 62               | 46(@4.5V)        | 640            | U-MOSV       |                       |                      |
|                          | SSM3J115TU  | -20           | $\pm 8$      | -2.2      | 353                            | 193              | 125              | 98               | 568            | U-MOSIV      |                       |                      |
|                          | SSM3J110TU  | -12           | $\pm 8$      | -2.3      | —                              | 240              | 145              | 94               | 550            | U-MOSIII     |                       |                      |
|                          | SSM3J109TU  | -20           | $\pm 8$      | -2.0      | —                              | 300              | 172              | 130              | 335            | U-MOSIII     |                       |                      |
|                          | SSM3J114TU  | -20           | $\pm 8$      | -1.8      | 526                            | 321              | 199              | 149              | 331            | U-MOSIV      |                       |                      |
|                          | SSM3J108TU  | -20           | $\pm 8$      | -1.8      | —                              | 363              | 230              | 158              | 250            | U-MOSIII     |                       |                      |
|                          | SSM3J113TU  | -20           | $\pm 12$     | -1.7      | —                              | —                | 249              | 169              | 370            | U-MOSIII     |                       |                      |
|                          | SSM3J111TU  | -20           | $\pm 12$     | -1.0      | —                              | —                | 680              | 480              | 160            | U-MOSIII     |                       |                      |
|                          | SSM3J117TU  | -30           | $\pm 20$     | -2.0      | —                              | —                | —                | 225              | 280            | U-MOSII      |                       |                      |
|                          | SSM3J118TU  | -30           | $\pm 20$     | -1.4      | —                              | —                | —                | 480              | 137            | U-MOSII      |                       |                      |
| SSM3J112TU               | -30         | $\pm 20$      | -1.1         | —         | —                              | —                | 790              | 86               | U-MOSII        |              |                       |                      |
| <b>UF6</b><br>           | SSM6J409TU  | -20           | $\pm 8$      | -9.5      | 72.3                           | 46.3             | 30.2             | 22.1(@4.5V)      | 1100           | U-MOSV       |                       |                      |
|                          | SSM6J51TU   | -12           | $\pm 8$      | -4.0      | 150                            | 85               | 54               | —                | 1700           | U-MOSIV      |                       |                      |
|                          | SSM6J50TU   | -20           | $\pm 10$     | -2.5      | —                              | 205(@2.0V)       | 100              | 64(@4.5V)        | 800            | U-MOSIV      |                       |                      |
|                          | SSM6J21TU   | -12           | $\pm 12$     | -3.0      | —                              | —                | 88               | 50               | 1300           | U-MOSIII     |                       |                      |
|                          | SSM6J401TU  | -30           | $\pm 20$     | -2.5      | —                              | —                | —                | 145              | 730            | U-MOSIII     |                       |                      |
| SSM6J402TU               | -30         | $\pm 20$      | -2.0         | —         | —                              | —                | 225              | 280              | U-MOSIII       |              |                       |                      |
| <b>US6(SOT-363)</b><br>  | SSM6J08FU   | -20           | $\pm 12$     | -1.3      | —                              | 460(@2.0V)       | 260              | 180              | 370            | U-MOSII      |                       |                      |
|                          | SSM6J06FU   | -20           | $\pm 12$     | -0.65     | —                              | —                | 700              | 500              | 160            | $\pi$ -MOSVI |                       |                      |
|                          | SSM6J07FU   | -30           | $\pm 20$     | -0.8      | —                              | —                | —                | 800              | 130            | $\pi$ -MOSVI |                       |                      |
| <b>TSM</b><br>           | SSM3J307T   | -20           | $\pm 8$      | -5.0      | 83                             | 56               | 40               | 31(@4.5V)        | 1170           | U-MOSV       |                       |                      |
|                          | SSM3J321T   | -20           | $\pm 8$      | -5.2      | 137                            | 88               | 62               | 46(@4.5V)        | 640            | U-MOSV       |                       |                      |
|                          | SSM3J326T*  | -30           | $\pm 12$     | -5.6      | —                              | 115              | 62.5             | 45.7(@4.5V)      | 640            | U-MOSVI      |                       |                      |
|                          | SSM3J13T    | -12           | $\pm 8$      | -3.0      | —                              | 180(@2.0V)       | 95               | 70               | 890            | U-MOSIII     |                       |                      |
|                          | SSM3J312T   | -12           | $\pm 8$      | -2.7      | —                              | 237              | 142              | 91               | 550            | U-MOSIII     |                       |                      |
|                          | SSM3J304T   | -20           | $\pm 8$      | -2.3      | —                              | 297              | 169              | 127              | 335            | U-MOSIII     |                       |                      |
|                          | SSM3J317T   | -20           | $\pm 8$      | -3.6      | —                              | 306              | 144              | 107(@4.5V)       | 390            | U-MOSIII     |                       |                      |
|                          | SSM3J313T   | -20           | $\pm 8$      | -1.6      | —                              | 640              | 396              | 268              | 170            | U-MOSIII     |                       |                      |
|                          | SSM3J01T    | -30           | $\pm 10$     | -1.7      | —                              | —                | 600              | 400              | 240            | $\pi$ -MOSVI |                       |                      |
|                          | SSM3J02T    | -30           | $\pm 10$     | -1.5      | —                              | —                | 700              | 500              | 150            | $\pi$ -MOSVI |                       |                      |
|                          | SSM3J314T   | -30           | $\pm 20$     | -3.5      | —                              | —                | —                | 100              | 505            | U-MOSIII-H   |                       |                      |
|                          | SSM3J14T    | -30           | $\pm 20$     | -2.7      | —                              | —                | —                | 170              | 413            | U-MOSII      |                       |                      |
|                          | SSM3J306T   | -30           | $\pm 20$     | -2.4      | —                              | —                | —                | 225              | 280            | U-MOSII      |                       |                      |
| SSM3J305T                | -30         | $\pm 20$      | -1.7         | —         | —                              | —                | 477              | 137              | U-MOSII        |              |                       |                      |
| <b>S-Mini</b><br>        | SSM3J327F*  | -20           | $\pm 8$      | -3.5      | 242                            | 170              | 125              | 95(@4.5V)        | 290            | U-MOSVI      |                       |                      |
|                          | SSM3J325F*  | -20           | $\pm 8$      | -2.0      | 362                            | 252              | 191              | 155(@4.5V)       | 226            | U-MOSVI      |                       |                      |

\*: Under development

\* The internal connection diagrams only show the general configurations of the circuits.

# Semi-Power N-Channel Single MOSFETs

Unit: mm

| Package   | Part Number   | V <sub>DSS</sub> (V) | V <sub>GSS</sub> (V) | I <sub>b</sub> (A) | R <sub>DS(ON)</sub> Max (mΩ) |                          |                          |                          | C <sub>iss</sub> (pF) | Series   | *Internal Connections   | Land Pattern Example  |
|---|---|----------------------|----------------------|--------------------|------------------------------|--------------------------|--------------------------|--------------------------|-----------------------|----------|---|---|
|   |   |                      |                      |                    | V <sub>GS</sub> =  1.5 V     | V <sub>GS</sub> =  1.8 V | V <sub>GS</sub> =  2.5 V | V <sub>GS</sub> =  4.0 V |                       |          |   |   |
| <b>CST4</b><br>            | <b>SSM4K27CT</b>  | 20                   | ±12                  | 0.5                | —                            | 390                      | 260                      | 205                      | 174                   | U-MOSIII | <br>TOP VIEW |    |
|   | <b>ES6 (SOT-563)</b><br> | <b>SSM6K211FE</b>    | 20                   | ±10                | 3.2                          | 118                      | 82                       | 59                       | 47(@4.5 V)            | 510      | U-MOSIII  |    |
| <b>SSM6K203FE</b>   |   | 20                   | ±10                  | 2.8                | 153                          | 106                      | 76                       | 61                       | 400                   | U-MOSIII |   |   |
| <b>SSM6K202FE</b>   |   | 30                   | ±12                  | 2.3                | —                            | 145                      | 101                      | 85                       | 270                   | U-MOSIII |   |   |
| <b>SSM6K204FE</b>   |   | 20                   | ±10                  | 2.0                | 307                          | 214                      | 164                      | 126                      | 195                   | U-MOSIII |   |   |
| <b>SSM6K208FE</b>   |   | 30                   | ±12                  | 1.9                | —                            | 296                      | 177                      | 133                      | 123                   | U-MOSIII |   |   |
| <b>SSM6K25FE</b>  |   | 20                   | ±12                  | 0.5                | —                            | 395                      | 190                      | 145                      | 268                   | U-MOSIII |   |   |
| <b>SSM6K24FE</b>  |   | 30                   | ±12                  | 0.5                | —                            | —                        | 180                      | 145                      | 245                   | U-MOSIII |   |   |
| <b>SSM6K22FE</b>  |   | 20                   | ±12                  | 1.4                | —                            | —                        | 230                      | 170                      | 125                   | U-MOSIII |   |   |
| <b>SSM6K210FE</b>   |   | 30                   | ±20                  | 1.4                | —                            | —                        | —                        | 371                      | 57                    | U-MOSIII |   |   |
| <b>SSM6K30FE</b>  |   | 20                   | ±20                  | 1.2                | —                            | —                        | —                        | 420                      | 60                    | π-MOSVII |   |   |
| <b>SSM6K31FE</b>  |   | 20                   | ±20                  | 1.2                | —                            | —                        | —                        | 540                      | 36                    | π-MOSVII |   |   |
| <b>UFM</b><br>            | <b>SSM3K123TU</b>   | 20                   | ±10                  | 4.2                | 66                           | 43                       | 32                       | 28                       | 1010                  | U-MOSIII |             |   |
|   | <b>SSM3K121TU</b>   | 20                   | ±10                  | 3.2                | 140                          | 93                       | 63                       | 48                       | 400                   | U-MOSIII |   |   |
|   | <b>SSM3K104TU</b>   | 20                   | ±12                  | 3.0                | —                            | 110                      | 74                       | 56                       | 320                   | U-MOSIII |   |   |
|   | <b>SSM3K119TU</b>   | 30                   | ±12                  | 2.5                | —                            | 134                      | 90                       | 74                       | 270                   | U-MOSIII |   |   |
|   | <b>SSM3K102TU</b>   | 20                   | ±12                  | 2.6                | —                            | 154                      | 99                       | 71                       | 268                   | U-MOSIII |   |   |
|   | <b>SSM3K122TU</b>   | 20                   | ±10                  | 2.0                | 304                          | 211                      | 161                      | 123                      | 195                   | U-MOSIII |   |   |
|   | <b>SSM3K101TU</b>   | 20                   | ±12                  | 2.2                | —                            | 230                      | 138                      | 103                      | 125                   | U-MOSIII |   |   |
|   | <b>SSM3K127TU</b>   | 30                   | ±12                  | 2.0                | —                            | 286                      | 167                      | 123                      | 123                   | U-MOSIII |   |   |
|   | <b>SSM3K116TU</b>   | 30                   | ±12                  | 2.2                | —                            | —                        | 135                      | 100                      | 245                   | U-MOSIII |   |   |
|   | <b>SSM3K131TU</b>   | 30                   | ±20                  | 6.0                | —                            | —                        | —                        | 41.5(@4.5 V)             | 450                   | U-MOSIV  |   |   |
|   | <b>SSM3K124TU</b>   | 30                   | ±20                  | 2.4                | —                            | —                        | —                        | 120                      | 180                   | π-MOSVII |   |   |
|   | <b>SSM3K105TU</b>   | 30                   | ±20                  | 2.1                | —                            | —                        | —                        | 200                      | 102                   | π-MOSVI  |   |   |
|   | <b>SSM3K128TU</b>   | 30                   | ±20                  | 1.5                | —                            | —                        | —                        | 360                      | 57                    | U-MOSIII |   |   |
|   | <b>SSM3K107TU</b>   | 20                   | ±20                  | 1.5                | —                            | —                        | —                        | 410                      | 60                    | π-MOSVII |   |   |
| <b>SSM3K106TU</b>   | 20  | ±20                  | 1.2                  | —                  | —                            | —                        | 530                      | 36                       | π-MOSVII              |          |   |   |
| <b>UF6</b><br>           | <b>SSM6K403TU</b>   | 20                   | ±10                  | 4.2                | 66                           | 43                       | 32                       | 28                       | 1050                  | U-MOSIII |            |  |
|   | <b>SSM6K404TU</b>   | 20                   | ±10                  | 3.0                | 147                          | 100                      | 70                       | 55                       | 400                   | U-MOSIII |   |   |
|   | <b>SSM6K405TU</b>   | 20                   | ±10                  | 2.0                | 307                          | 214                      | 164                      | 126                      | 195                   | U-MOSIII |   |   |
|   | <b>SSM6K18TU</b>  | 20                   | ±12                  | 4.0                | —                            | —                        | 54                       | 40                       | 1100                  | U-MOSIII |   |   |
|   | <b>SSM6K406TU</b>   | 30                   | ±20                  | 4.4                | —                            | —                        | —                        | 38.5(@4.5 V)             | 490                   | U-MOSIV  |   |   |
|   | <b>SSM6K34TU</b>  | 30                   | ±20                  | 3.0                | —                            | —                        | —                        | 77(@4.5 V)               | 470                   | U-MOSIII |   |   |
|   | <b>SSM6K407TU</b>   | 60                   | ±20                  | 2.0                | —                            | —                        | —                        | 440                      | 150                   | π-MOSV   |   |   |
| <b>SSM6K32TU</b>  | 60  | ±20                  | 2.0                  | —                  | —                            | —                        | 440                      | 140                      | π-MOSV                |          |   |   |
| <b>US6 (SOT-363)</b><br> | <b>SSM6K08FU</b>  | 20                   | ±12                  | 1.6                | —                            | 210(@2.0 V)              | 140                      | 105                      | 306                   | U-MOSII  |            |  |
|   | <b>SSM6K06FU</b>  | 20                   | ±12                  | 1.1                | —                            | —                        | 210                      | 160                      | 125                   | π-MOSVI  |   |   |
|   | <b>SSM6K07FU</b>  | 30                   | ±20                  | 1.5                | —                            | —                        | —                        | 220                      | 102                   | π-MOSVI  |   |   |
| <b>TSM</b><br>           | <b>SSM3K310T</b>  | 20                   | ±10                  | 5.0                | 66                           | 43                       | 32                       | 28                       | 1120                  | U-MOSIII |            |  |
|   | <b>SSM3K309T</b>  | 20                   | ±12                  | 4.7                | —                            | 47                       | 35                       | 31                       | 1020                  | U-MOSIII |   |   |
|   | <b>SSM3K301T</b>  | 20                   | ±12                  | 3.5                | —                            | 110                      | 74                       | 56                       | 320                   | U-MOSIII |   |   |
|   | <b>SSM3K316T</b>  | 30                   | ±12                  | 4.0                | —                            | 131                      | 87                       | 65(@4.5 V)               | 270                   | U-MOSIII |   |   |
|   | <b>SSM3K01T</b>   | 30                   | ±10                  | 3.2                | —                            | —                        | 150                      | 120                      | 152                   | π-MOSVI  |   |   |
|   | <b>SSM3K02T</b>   | 30                   | ±10                  | 2.5                | —                            | —                        | 250                      | 200                      | 115                   | π-MOSVI  |   |   |
|   | <b>SSM3K315T</b>  | 30                   | ±20                  | 6.0                | —                            | —                        | —                        | 41.5(@4.5 V)             | 450                   | U-MOSIV  |   |   |
|   | <b>SSM3K14T</b>   | 30                   | ±20                  | 4.0                | —                            | —                        | —                        | 67                       | 460                   | U-MOSII  |   |   |
|   | <b>SSM3K320T</b>  | 30                   | ±20                  | 4.2                | —                            | —                        | —                        | 77(@4.5 V)               | 190                   | U-MOSIV  |   |   |
|   | <b>SSM3K303T</b>  | 30                   | ±20                  | 2.9                | —                            | —                        | —                        | 120                      | 180                   | π-MOSVII |   |   |
|   | <b>SSM3K12T</b>   | 30                   | ±20                  | 3.0                | —                            | —                        | —                        | 175                      | 120                   | π-MOSVII |   |   |
| <b>SSM3K318T</b>  | 60  | ±20                  | 2.5                  | —                  | —                            | —                        | 145(@4.5 V)              | 235                      | U-MOSIV               |          |   |   |

\* The internal connection diagrams only show the general configurations of the circuits.

# 4

# Low- $V_{DSS}$ MOSFETs (in Small SMD Packages)

## Semi-Power Dual MOSFETs

Unit: mm

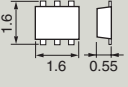
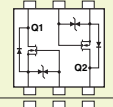
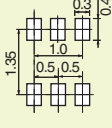
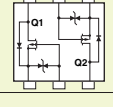
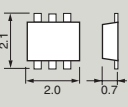
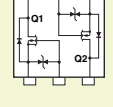
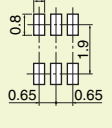
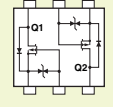
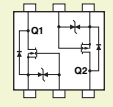
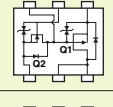
| Package   | Polarity                  | Part Number       | $V_{DSS}$ (V) | $V_{GS}$ (V) | $I_D$ (A) | $R_{DS(ON)}$ Max (m $\Omega$ ) |                   |                   |                   | $C_{iss}$ (pF) | Series       | *Internal Connections   | Land Pattern Example   |
|---|---------------------------|-------------------|---------------|--------------|-----------|--------------------------------|-------------------|-------------------|-------------------|----------------|--------------|---|--|
|   |                           |                   |               |              |           | $V_{GS} =  1.5V $              | $V_{GS} =  1.8V $ | $V_{GS} =  2.5V $ | $V_{GS} =  4.0V $ |                |              |   |  |
| <b>ES6 (SOT-563)</b><br> | N-ch x 2                  | <b>SSM6N42FE*</b> | 20            | $\pm 10$     | 0.77      | 630                            | 460               | 340               | 260 (@4.5V)       | 95             | U-MOSIII     |    |   |
|   | P-ch x 2                  | <b>SSM6P41FE</b>  | -20           | $\pm 8$      | -0.72     | 1040                           | 670               | 440               | 300 (@4.5V)       | 110            | U-MOSV       |    |  |
| <b>UF6</b><br>          | N-ch x 2                  | <b>SSM6N39TU</b>  | 20            | $\pm 10$     | 1.6       | 247                            | 190               | 139               | 119               | 260            | U-MOSIII     |    |  |
|   |                           | <b>SSM6N29TU</b>  | 20            | $\pm 12$     | 0.8       | —                              | 235               | 178               | 143               | 268            | U-MOSIII     |   |  |
|   |                           | <b>SSM6N25TU</b>  | 20            | $\pm 12$     | 0.5       | —                              | 395               | 190               | 145               | 268            | U-MOSIII     |   |  |
|   |                           | <b>SSM6N24TU</b>  | 30            | $\pm 12$     | 0.5       | —                              | —                 | 180               | 145               | 245            | U-MOSIII     |   |  |
|   |                           | <b>SSM6N40TU</b>  | 30            | $\pm 20$     | 1.6       | —                              | —                 | —                 | 182               | 180            | U-MOSIII     |   |  |
|   | P-ch x 2                  | <b>SSM6P54TU</b>  | -20           | $\pm 8$      | -1.2      | 555                            | 350               | 228               | —                 | 331            | U-MOSIV      |    |  |
|   |                           | <b>SSM6P39TU</b>  | -20           | $\pm 8$      | -1.5      | —                              | 430               | 294               | 213               | 250            | U-MOSIII     |   |  |
|   |                           | <b>SSM6P28TU</b>  | -20           | $\pm 8$      | -0.8      | —                              | 460               | 306               | 234               | 250            | U-MOSIII     |   |  |
|   |                           | <b>SSM6P26TU</b>  | -20           | $\pm 8$      | -0.5      | —                              | 980               | 330               | 230               | 250            | U-MOSIII     |   |  |
|   |                           | <b>SSM6P25TU</b>  | -20           | $\pm 12$     | -0.5      | —                              | —                 | 430               | 260               | 218            | U-MOSIII     |   |  |
|   | N-ch + P-ch               | <b>SSM6L39TU</b>  | 20            | $\pm 10$     | 1.6       | 247                            | 190               | 139               | 119               | 260            | U-MOSIII     |   |  |
|   |                           |                   | -20           | $\pm 8$      | -1.5      | —                              | 430               | 294               | 213               | 250            | U-MOSIII     |   |  |
|   |                           | <b>SSM6L13TU</b>  | 20            | $\pm 12$     | 0.8       | —                              | 235               | 178               | 143               | 268            | U-MOSIII     |   |  |
|   |                           | -20               | $\pm 8$       | -0.8         | —         | 460                            | 306               | 234               | 250               | U-MOSIII       |              |   |  |
|   |                           | <b>SSM6L10TU</b>  | 20            | $\pm 12$     | 0.5       | —                              | 395               | 190               | 145               | 268            | U-MOSIII     |   |  |
|   |                           | -20               | $\pm 8$       | -0.5         | —         | 980                            | 330               | 230               | 250               | U-MOSIII       |              |   |  |
|   |                           | <b>SSM6L11TU</b>  | 20            | $\pm 12$     | 0.5       | —                              | 395               | 190               | 145               | 268            | U-MOSIII     |   |  |
|   |                           | -20               | $\pm 12$      | -0.5         | —         | —                              | 430               | 260               | 218               | U-MOSIII       |              |   |  |
|   | P-ch + N-ch (Load Switch) | <b>SSM6E01TU</b>  | -12           | $\pm 12$     | -1.0      | —                              | —                 | 240               | 160               | 310            | U-MOSIII     |  |  |
|   |                           |                   | 20            | 10           | 0.05      | —                              | —                 | 10 $\Omega$       | —                 | 11             | $\pi$ -MOSVI |   |  |
|   |                           | <b>SSM6E02TU</b>  | -20           | $\pm 8$      | -1.8      | 364                            | 204               | 136               | —                 | 568            | U-MOSIV      |   |  |
|   |                           |                   | 20            | $\pm 10$     | 0.1       | 15 $\Omega$                    | —                 | 4 $\Omega$        | 3 $\Omega$        | 9.3            | $\pi$ -MOSVI |   |  |
|   |                           | <b>SSM6E03TU</b>  | -20           | $\pm 8$      | -1.8      | —                              | 335               | 180               | 144               | 335            | U-MOSIII     |   |  |
|   |                           |                   | 20            | $\pm 10$     | 0.1       | 15 $\Omega$                    | —                 | 4 $\Omega$        | 3 $\Omega$        | 9.3            | $\pi$ -MOSVI |   |  |

\*: Under development

\* The internal connection diagrams only show the general configurations of the circuits.

## MOSFET with a Schottky Barrier Diode

Unit: mm

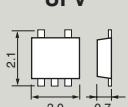
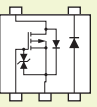
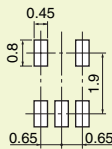
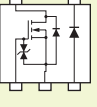
| Package   | Polarity  | Part Number      | MOSFET        |              |           |                                |                   |                   |                   |                |            |           | SBD       |                           |     | *Internal Connections   | Land Pattern Example  |
|---|-----------|------------------|---------------|--------------|-----------|--------------------------------|-------------------|-------------------|-------------------|----------------|------------|-----------|-----------|---------------------------|-----|---|---|
|   |           |                  | $V_{DSS}$ (V) | $V_{GS}$ (V) | $I_D$ (A) | $R_{DS(ON)}$ Max (m $\Omega$ ) |                   |                   |                   | $C_{iss}$ (pF) | Series     | $V_R$ (V) | $I_o$ (A) | $V_F$ Max (V) @ $I_F$ (A) |     |   |   |
|   |           |                  |               |              |           | $V_{GS} =  1.5V $              | $V_{GS} =  1.8V $ | $V_{GS} =  2.5V $ | $V_{GS} =  4.0V $ |                |            |           |           |                           |     |   |   |
| <b>UFV</b><br> | P-ch+ SBD | <b>SSM5G09TU</b> | -12           | $\pm 8$      | -1.5      | —                              | —                 | 200               | 130               | 550            | U-MOSII    | 12        | 0.5       | 0.43                      | 0.5 |  |  |
|   |           | <b>SSM5G02TU</b> | -12           | $\pm 12$     | -1.0      | —                              | —                 | 240               | 160               | 310            | U-MOSII    | 12        | 0.5       | 0.43                      | 0.5 |   |   |
|   |           | <b>SSM5G10TU</b> | -20           | $\pm 8$      | -1.5      | —                              | 430               | 294               | 213               | 250            | U-MOSIII   | 20        | 0.7       | 0.39                      | 0.5 |   |   |
|   |           | <b>SSM5G04TU</b> | -12           | $\pm 12$     | -1.0      | —                              | —                 | 420               | 240               | 170            | U-MOSII    | 12        | 0.5       | 0.43                      | 0.5 |   |   |
|   |           | <b>SSM5G11TU</b> | -30           | $\pm 20$     | -1.4      | —                              | —                 | —                 | 403               | 120            | U-MOSIII-H | 30        | 0.7       | 0.41                      | 0.5 |   |   |
|   |           | <b>SSM5G01TU</b> | -30           | $\pm 20$     | -1.0      | —                              | —                 | —                 | 800               | 86             | U-MOSII    | 20        | 0.5       | 0.45                      | 0.3 |   |   |
|   | N-ch+ SBD | <b>SSM5H10TU</b> | 20            | $\pm 10$     | 1.6       | 247                            | 190               | 139               | 119               | 260            | U-MOSIII   | 20        | 0.7       | 0.39                      | 0.5 |  |   |
|   |           | <b>SSM5H12TU</b> | 30            | $\pm 12$     | 1.9       | —                              | 296               | 177               | 133               | 123            | U-MOSIII   | 30        | 0.7       | 0.41                      | 0.5 |   |   |
|   |           | <b>SSM5H05TU</b> | 20            | $\pm 12$     | 1.5       | —                              | —                 | 220               | 160               | 125            | U-MOSIII   | 12        | 0.5       | 0.43                      | 0.5 |   |   |
|   |           | <b>SSM5H08TU</b> | 20            | $\pm 12$     | 1.5       | —                              | —                 | 220               | 160               | 125            | U-MOSIII   | 20        | 0.5       | 0.45                      | 0.3 |   |   |
|   |           | <b>SSM5H03TU</b> | 12            | $\pm 12$     | 1.4       | —                              | —                 | —                 | 300               | 125            | U-MOSII    | 12        | 0.5       | 0.43                      | 0.5 |   |   |
|   |           | <b>SSM5H11TU</b> | 30            | $\pm 20$     | 1.6       | —                              | —                 | —                 | 182               | 180            | U-MOSIII   | 30        | 0.7       | 0.41                      | 0.5 |   |   |
|   |           | <b>SSM5H01TU</b> | 30            | $\pm 20$     | 1.4       | —                              | —                 | —                 | 450               | 106            | U-MOSII    | 20        | 0.5       | 0.45                      | 0.3 |   |   |
| <b>SSM5H07TU</b>  | 20        | $\pm 20$         | 1.2           | —            | —         | —                              | 540               | 36                | $\pi$ -MOSVII     | 12             | 0.5        | 0.43      | 0.5       |                           |     |   |   |

\* The internal connection diagrams only show the general configurations of the circuits.

## MOSFET with a Schottky Barrier Diode

Unit: mm

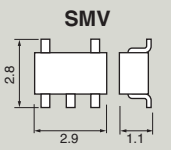
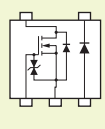
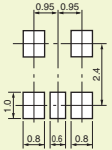
| Package   | Polarity  | Part Number | MOSFET               |                      |                    |                              |                        |                        |                        | SBD                   |          |                    |                    | *Internal Connections | Land Pattern Example |   |   |
|---|-----------|-------------|----------------------|----------------------|--------------------|------------------------------|------------------------|------------------------|------------------------|-----------------------|----------|--------------------|--------------------|-----------------------|----------------------|---|---|
|   |           |             | V <sub>DSS</sub> (V) | V <sub>GSS</sub> (V) | I <sub>D</sub> (A) | R <sub>DS(ON)</sub> Max (mΩ) |                        |                        |                        | C <sub>iss</sub> (pF) | Series   | V <sub>R</sub> (V) | I <sub>O</sub> (A) |                       |                      | V <sub>F</sub> Max (V)  |   |
|   |           |             |                      |                      |                    | V <sub>GS</sub> = 1.5V       | V <sub>GS</sub> = 1.8V | V <sub>GS</sub> = 2.5V | V <sub>GS</sub> = 4.0V |                       |          |                    |                    |                       |                      |   |   |
|  | N-ch+ SBD | SSM5H14F    | 30                   | ±12                  | 3.0                | —                            | 138                    | 94                     | 78                     | 270                   | U-MOSIII | 45                 | 0.1                | 0.6                   | 0.1                  |  |  |

\* The internal connection diagrams only show the general configurations of the circuits.

## VS-6 Series ... [Part Number: TPC6xxx]

### Features

- Zener diode between gate and source for all products
- Thin package, with a board mounting height as low as 0.85 mm (max)



### Product Offerings

| Part Number | Absolute Maximum Ratings |                      |                    | Circuit Configuration | R <sub>DS(ON)</sub> Max (mΩ) |       |       |       |       | Q <sub>g</sub> Typ. (nC) | C <sub>iss</sub> Typ. (pF) | Marking | Series     |
|-------------|--------------------------|----------------------|--------------------|-----------------------|------------------------------|-------|-------|-------|-------|--------------------------|----------------------------|---------|------------|
|             | V <sub>DSS</sub> (V)     | V <sub>GSS</sub> (V) | I <sub>D</sub> (A) |                       | 10 V                         | 4.5 V | 2.5 V | 2.0 V | 1.8 V |                          |                            |         |            |
| TPC6004     | 20                       | ±12                  | 6                  | N-ch Single           | —                            | 24    | 32    | 37    | —     | 17                       | 1400                       | S2C     | U-MOSIII   |
| TPC6011 ☆*  | 30                       | ±20                  | 6                  |                       | 20                           | 32    | —     | —     | —     | 14                       | 640                        | S2L     | U-MOSIV    |
| TPC6005     | 30                       | ±12                  | 6                  |                       | —                            | 28    | 35    | 41    | —     | 19                       | 1420                       | S2E     | U-MOSIII   |
| TPC6007-H   | 30                       | ±20                  | 5                  |                       | 54                           | 79    | —     | —     | —     | 2.8                      | 240                        | S2G     | U-MOSIII-H |
| TPC6006-H   | 40                       | ±20                  | 3.9                |                       | 75                           | 100   | —     | —     | —     | 2.4                      | 251                        | S2F     | U-MOSIII-H |
| TPC6103     | -12                      | ±8                   | -5.5               | P-ch Single           | —                            | 35    | 55    | —     | 90    | 20                       | 1520                       | S3C     | U-MOSIII   |
| TPC6105     | -20                      | ±8                   | -2.7               |                       | —                            | 110   | 160   | —     | 300   | 6                        | 470                        | S3E     | U-MOSIII   |
| TPC6107     | -20                      | ±12                  | -4.5               |                       | —                            | 55    | 100   | 180   | —     | 9.8                      | 680                        | S3G     | U-MOSIV    |
| TPC6111     | -20                      | ±8                   | -5.5               |                       | —                            | 40    | 57    | —     | 80    | 10                       | 700                        | S3L     | U-MOSV     |
| TPC6108     | -30                      | ±20                  | -4.5               |                       | 60                           | 100   | —     | —     | —     | 13                       | 570                        | S3H     | U-MOSIV    |
| TPC6109-H   | -30                      | ±20                  | -5                 |                       | 59                           | 83    | —     | —     | —     | 7.2                      | 471                        | S3J     | U-MOSIII-H |

☆: No protection Zener diode between gate and source \* : Under development

## VS-8 Series ... [Part Number: TPCF8xxx]

### Features

- Ultra-low ON-resistance achieved by employing the U-MOS process
- Thin package, with a board mounting height as low as 0.85 mm (max)
- 32% reduction in mounting area compared with the VS-6 (TSOP-6) Series, due to the use of a high-density flat package
- P<sub>D</sub> = 2.5 W @ t = 5 s when the device is mounted on a glass epoxy board



### Product Offerings

| Part Number | Absolute Maximum Ratings |                      |                    | Circuit Configuration | R <sub>DS(ON)</sub> Max (mΩ) |       |       |       |       | Q <sub>g</sub> Typ. (nC) | C <sub>iss</sub> Typ. (pF) | Marking | Series   |
|-------------|--------------------------|----------------------|--------------------|-----------------------|------------------------------|-------|-------|-------|-------|--------------------------|----------------------------|---------|----------|
|             | V <sub>DSS</sub> (V)     | V <sub>GSS</sub> (V) | I <sub>D</sub> (A) |                       | 10 V                         | 4.5 V | 2.5 V | 2.0 V | 1.8 V |                          |                            |         |          |
| TPCF8002 ☆  | 30                       | ±20                  | 6                  | N-ch Single           | 23                           | 31    | —     | —     | —     | TBD                      | TBD                        | F2B     | U-MOSIV  |
| TPCF8101    | -12                      | ±8                   | -6                 | P-ch Single           | —                            | 28    | 40    | —     | 85    | 18                       | 1600                       | F3A     | U-MOSIII |
| TPCF8103    | -20                      | ±8                   | -2.7               |                       | —                            | 110   | 160   | —     | 300   | 6                        | 470                        | F3C     | U-MOSIII |
| TPCF8102    | -20                      | ±8                   | -6                 |                       | —                            | 30    | 41    | —     | 90    | 19                       | 1550                       | F3B     | U-MOSIII |
| TPCF8104    | -30                      | ±20                  | -6                 |                       | 28                           | 38    | —     | —     | —     | 34                       | 1760                       | F3D     | U-MOSIV  |
| TPCF8201    | 20                       | ±12                  | 3                  | N-ch Dual             | —                            | 49    | 66    | 100   | —     | 7.5                      | 590                        | F4A     | U-MOSIII |
| TPCF8301    | -20                      | ±8                   | -2.7               | P-ch Dual             | —                            | 110   | 160   | —     | 300   | 6                        | 470                        | F5A     | U-MOSIII |
| TPCF8302    | -20                      | ±10                  | -3                 |                       | —                            | 59    | 95    | 200   | —     | 11                       | 800                        | F5B     | U-MOSIV  |
| TPCF8303    | -20                      | ±8                   | -3                 |                       | —                            | 58    | 87    | —     | 250   | 11                       | 860                        | F5C     | U-MOSIV  |
| TPCF8304    | -30                      | ±20                  | -3.2               |                       | 72                           | 105   | —     | —     | —     | 14                       | 600                        | F5D     | U-MOSIV  |
| TPCF8402    | 30                       | ±20                  | 4                  | N-ch + P-ch           | 50                           | 77    | —     | —     | —     | 10                       | 470                        | F6B     | U-MOSIII |
|             | -30                      | ±20                  | -3.2               |                       | 72                           | 105   | —     | —     | —     | 14                       | 600                        |         | U-MOSIV  |
| TPCF8A01    | 20                       | ±12                  | 3.0                | N-ch + SBD            | —                            | 49    | 66    | 100   | —     | 7.5                      | 590                        | F7A     | U-MOSIII |
| TPCF8B01    | -20                      | ±8                   | -2.7               | P-ch + SBD            | —                            | 110   | 160   | —     | 300   | 6                        | 470                        | F8A     | U-MOSIII |

☆: No protection Zener diode between gate and source

### ● PS-8 Series ... [Part Number: TPCP8xxx]

#### ■ Features

- Same mounting area as for the VS-6 (TSOP-6) Series
- Using flat leads and the latest U-MOS process (U-MOSIV), the PS-8 Series offers a 70% reduction in  $R_{DS(ON)}$  compared with the VS-6 Series.

#### ■ Product Offerings

| Part Number  | Absolute Maximum Ratings |               |           | Circuit Configuration | $R_{DS(ON)}$ Max (m $\Omega$ ) |       |     |            |            | $Q_g$ Typ. (nC) | $C_{iss}$ Typ. (pF) | Series     |
|--------------|--------------------------|---------------|-----------|-----------------------|--------------------------------|-------|-----|------------|------------|-----------------|---------------------|------------|
|              | $V_{DSS}$ (V)            | $V_{GSS}$ (V) | $I_D$ (A) |                       | 10 V                           | 4.5 V | 4 V | 2.5 V      | 1.8 V      |                 |                     |            |
| TPCP8006 ☆   | 20                       | $\pm 12$      | 9.1       | N-ch Single           | —                              | 10    | —   | 13.7       | —          | 22              | 1480                | U-MOSIV    |
| TPCP8001-H   | 30                       | $\pm 20$      | 7.2       |                       | 16                             | 25    | —   | —          | —          | 11              | 640                 | U-MOSIII-H |
| TPCP8004 ☆   | 30                       | $\pm 20$      | 8.3       |                       | 8.5                            | 14.5  | —   | —          | —          | 26              | 1270                | U-MOSIV    |
| TPCP8005-H ☆ | 30                       | $\pm 20$      | 11        |                       | 12.9                           | 15.7  | —   | —          | —          | 20              | 1433                | U-MOSV-H   |
| TPCP8A05-H ☆ | 30                       | $\pm 20$      | 8         | MOSBD                 | 17.5                           | 21.9  | —   | —          | —          | 16              | 1300                | U-MOSV-H   |
| TPCP8003-H ☆ | 100                      | $\pm 20$      | 2.2       | N-ch Single           | 180                            | 190   | —   | —          | —          | 7.5             | 360                 | U-MOSIII-H |
| TPCP8101     | -20                      | $\pm 8$       | -5.6      | P-ch Single           | —                              | 30    | —   | 41         | 90         | 19              | 1550                | U-MOSIII   |
| TPCP8102     | -20                      | $\pm 12$      | -7.2      |                       | —                              | 18    | —   | 30         | —          | 33              | 2560                | U-MOSIV    |
| TPCP8103-H   | -40                      | $\pm 20$      | -4.8      |                       | 40                             | 54    | —   | —          | —          | 19              | 800                 | U-MOSIII-H |
| TPCP8201     | 30                       | $\pm 20$      | 4.2       | N-ch Dual             | 50                             | 77    | —   | —          | —          | 10              | 470                 | U-MOSIII   |
| TPCP8202     | 30                       | $\pm 12$      | 5.5       |                       | —                              | 23    | —   | 39         | —          | 28              | 2150                | U-MOSIV    |
| TPCP8203     | 40                       | $\pm 20$      | 4.7       | P-ch Dual             | 40                             | 60    | —   | —          | —          | 16              | 770                 | U-MOSIII   |
| TPCP8301     | -20                      | $\pm 12$      | -5        |                       | —                              | 31    | —   | 60         | —          | 20              | 1500                | U-MOSIV    |
| TPCP8302     | -20                      | $\pm 12$      | -5        |                       | —                              | —     | 33  | 45         | 95         | 20              | 1500                | U-MOSIV    |
| TPCP8303     | -20                      | $\pm 8$       | -3.8      |                       | —                              | 40    | —   | 57         | —          | 10              | 640                 | U-MOSV     |
| TPCP8401     | 20                       | $\pm 10$      | 0.1       |                       | N-ch/P-ch Load Switch          | —     | —   | 3 $\Omega$ | 4 $\Omega$ | —               | —                   | —          |
| TPCP8402     | 30                       | $\pm 20$      | 4.2       | N-ch + P-ch           | 50                             | 77    | —   | —          | —          | 10              | 470                 | U-MOSIII   |
|              | -30                      | $\pm 20$      | -3.4      |                       | 72                             | 105   | —   | —          | —          | 14              | 600                 | U-MOSIV    |
| TPCP8404 ☆   | 30                       | $\pm 20$      | 4         | N-ch + P-ch           | 50                             | 100   | —   | —          | —          | 4.6             | 190                 | U-MOSIV    |
|              | -30                      | $\pm 20$      | -4        |                       | 50                             | 100   | —   | —          | —          | 13              | 510                 | U-MOSV     |
| TPCP8403     | 40                       | $\pm 20$      | 4.7       | N-ch + P-ch           | 40                             | 60    | —   | —          | —          | 16              | 770                 | U-MOSIII   |
|              | -40                      | $\pm 20$      | -3.4      |                       | 70                             | 105   | —   | —          | —          | 15              | 680                 | U-MOSIII   |
| TPCP8BA1     | -20                      | $\pm 12$      | -1.3      | MOSBD                 | —                              | —     | 180 | 260        | —          | —               | —                   | U-MOSII    |
| TPCP8AA1     | 20                       | $\pm 12$      | 1.6       | —                     | —                              | 105   | 140 | —          | —          | —               | —                   | U-MOSII    |
| TPCP8J01     | -32                      | $\pm 20$      | -5.5      | P-ch + NPN            | 35                             | —     | 49  | —          | —          | 34              | 1760                | U-MOSIV    |
|              | 50                       | —             | 0.1       |                       | —                              | —     | —   | —          | —          | —               | —                   | —          |

☆: No protection Zener diode between gate and source

### ● Chip LGA Series ... [Part Number: TPCL4xxx]

#### ■ Features

- Chip-scale package for high-density board assembly (58% reduction in mounting area compared with the STP2 package)

#### ■ Product Offerings

| Part Number | Absolute Maximum Ratings |               |           | Circuit Configuration | $R_{DS(ON)}$ Max (m $\Omega$ ) |      |       |       | $Q_g$ Typ. (nC) | $C_{iss}$ Typ. (pF) | Series |
|-------------|--------------------------|---------------|-----------|-----------------------|--------------------------------|------|-------|-------|-----------------|---------------------|--------|
|             | $V_{DSS}$ (V)            | $V_{GSS}$ (V) | $I_D$ (A) |                       | 4.5 V                          | 4 V  | 3.1 V | 2.5 V |                 |                     |        |
| TPCL4201 ☆  | 20                       | $\pm 12$      | 6         | N-ch Dual             | 31                             | 33   | 44    | 52    | 11.5            | 720                 | U-MOSV |
| TPCL4203 ☆* | 24                       | $\pm 12$      | 6         |                       | (36)                           | (38) | (46)  | (55)  | (10)            | (685)               | U-MOSV |
| TPCL4202 ☆* | 30                       | $\pm 12$      | 6         |                       | (40)                           | (42) | (50)  | (64)  | (10)            | (780)               | U-MOSV |

☆: No protection Zener diode between gate and source \* : Under development

### ● STP2 Series ... [Part Number: TPCT4xxx]

#### ■ Features

- The combination of a new chip design using Toshiba U-MOSIV process technology and a new small pump-structured package, offers low ON-resistance.

#### ■ Product Offerings

| Part Number | Absolute Maximum Ratings |               |           | Circuit Configuration | $R_{SS(ON)}$ Max (m $\Omega$ ) |     |       | $Q_g$ Typ. (nC) | $C_{iss}$ Typ. (pF) | Series  |
|-------------|--------------------------|---------------|-----------|-----------------------|--------------------------------|-----|-------|-----------------|---------------------|---------|
|             | $V_{SS}$ (V)             | $V_{GSS}$ (V) | $I_S$ (A) |                       | 2.5 V                          | 4 V | 4.5 V |                 |                     |         |
| TPCT4203    | 20                       | $\pm 12$      | 6         | N-ch Dual             | 49                             | 32  | 31    | 11              | 790                 | U-MOSIV |
| TPCT4204    | 30                       | $\pm 12$      | 6         |                       | 52                             | 39  | 38    | 12              | 780                 | U-MOSIV |

## ● TSON Advance Series ... [Part Number: TPCC8xxx]

### ■ Features

- The small thermally enhanced package gives a 64% reduction in mounting area compared with SOP-8, yet an equivalent maximum permissible power dissipation.

### ■ Product Offerings

| Part Number  | Absolute Maximum Ratings |                      |                    | Circuit Configuration | R <sub>DS(ON)</sub> Max (mΩ) |       |      |       | Q <sub>g</sub> Typ. (nC) | C <sub>iss</sub> Typ. (pF) | Series                                  |
|--------------|--------------------------|----------------------|--------------------|-----------------------|------------------------------|-------|------|-------|--------------------------|----------------------------|---|
|              | V <sub>DSS</sub> (V)     | V <sub>GSS</sub> (V) | I <sub>D</sub> (A) |                       | 10 V                         | 4.5 V | 4 V  | 2.5 V |                          |                            |   |
| TPCC8007 ☆*  | 20                       | ±12                  | 27                 | N-ch Single           | —                            | (4.6) | —    | (8.7) | TBD                      | TBD                        | U-MOSIV                                 |
| TPCC8008 ☆   | 30                       | ±25                  | 25                 |                       | 6.8                          | 12.8  | —    | —     | 30                       | 1600                       | U-MOSIV                                 |
| TPCC8003-H ☆ | 30                       | ±20                  | 13                 |                       | 16.9                         | 19.3  | —    | —     | 8.6                      | 990                        | U-MOSVI-H                               |
| TPCC8001-H ☆ | 30                       | ±20                  | 22                 |                       | 8.3                          | 10.6  | —    | —     | 14.3                     | 1900                       | U-MOSV-H                                |
| TPCC8002-H ☆ | 30                       | ±20                  | 22                 |                       | 8.3                          | 10.6  | —    | —     | 14.3                     | 1900                       | U-MOSV-H,<br>r <sub>g</sub> =3.2Ω(Typ.) |
| TPCC8A01-H ☆ | 30                       | ±20                  | 21                 | MOSBD                 | 9.9                          | 12.6  | —    | —     | 10.1                     | 1430                       | U-MOSV-H                                |
| TPCC8006-H ☆ | 30                       | ±20                  | 22                 | N-ch Single           | 8.0                          | 9.3   | —    | —     | 15.0                     | 1700                       | U-MOSVI-H                               |
| TPCC8005-H ☆ | 30                       | ±20                  | 26                 |                       | 6.4                          | 7.4   | —    | —     | 19.0                     | 2200                       | U-MOSVI-H                               |
| TPCC8102 ☆   | -30                      | ±20                  | -15                | P-ch Single           | 18.9                         | —     | 33.2 | —     | 26                       | 1200                       | U-MOSV                                  |
| TPCC8103 ☆   | -30                      | ±20                  | -18                |                       | 12                           | —     | 22   | —     | 38                       | 1600                       | U-MOSV                                  |

☆: No protection Zener diode between gate and source \* : Under development

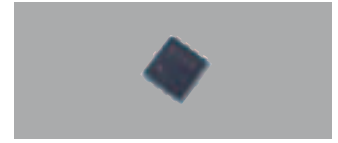

## ● TSSOP Advance Series ... [Part Number: TPCM8xxx]

### ■ Product Offerings

| Part Number  | Absolute Maximum Ratings |                      |                    | Circuit Configuration | R <sub>DS(ON)</sub> Max (mΩ) |       |     | Q <sub>g</sub> Typ. (nC) | C <sub>iss</sub> Typ. (pF) | Series     |
|--------------|--------------------------|----------------------|--------------------|-----------------------|------------------------------|-------|-----|--------------------------|----------------------------|------------|
|              | V <sub>DSS</sub> (V)     | V <sub>GSS</sub> (V) | I <sub>D</sub> (A) |                       | 10 V                         | 4.5 V | 4 V |                          |                            |            |
| TPCM8001-H   | 30                       | ±20                  | 20                 | N-ch Single           | 9.5                          | 14    | —   | 19                       | 1130                       | U-MOSIII-H |
| TPCM8003-H ☆ | 30                       | ±20                  | 21                 |                       | 12.9                         | 15.7  | —   | 11                       | 1433                       | U-MOSV-H   |
| TPCM8004-H ☆ | 30                       | ±20                  | 24                 |                       | 11                           | 13.4  | —   | 11                       | 1433                       | U-MOSV-H   |
| TPCM8006     | 30                       | ±20                  | 25                 |                       | 7.0                          | 13.5  | —   | 26                       | 1270                       | U-MOSIV    |
| TPCM8002-H ☆ | 30                       | ±20                  | 30                 |                       | 6.2                          | 8.2   | —   | 18                       | 2270                       | U-MOSV-H   |
| TPCM8A05-H ☆ | 30                       | ±20                  | 20                 | MOSBD                 | 12.9                         | 17.2  | —   | 7.4                      | 1300                       | U-MOSV-H   |
| TPCM8102     | -30                      | ±20                  | -25                | P-ch Single           | 7.7                          | —     | 16  | 60                       | 2450                       | U-MOSV     |

☆: No protection Zener diode between gate and source

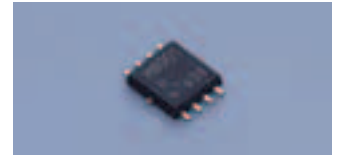

## ● SOP-8 Series ... [Part Number: TPC8xxx]

### ■ Features

- Low ON-resistance and high-speed-switching series are available.  
Low ON-resistance series: U-MOSIV/V/VI  
High-speed-switching series: U-MOSIII-H and U-MOSV-H
- ON-resistance reduction through the use of an Al strap structure

### ■ Product Offerings

| Part Number | Absolute Maximum Ratings |                      |                    | Circuit Configuration | R <sub>DS(ON)</sub> Max (mΩ) |       |     |       | Q <sub>g</sub> Typ. (nC) | C <sub>iss</sub> Typ. (pF) | Series     |
|-------------|--------------------------|----------------------|--------------------|-----------------------|------------------------------|-------|-----|-------|--------------------------|----------------------------|------------|
|             | V <sub>DSS</sub> (V)     | V <sub>GSS</sub> (V) | I <sub>D</sub> (A) |                       | 10 V                         | 4.5 V | 4 V | 2.5 V |                          |                            |            |
| TPC8021-H   | 30                       | ±20                  | 11                 | N-ch Single           | 17                           | 25    | —   | —     | 11                       | 640                        | U-MOSIII-H |
| TPC8025 ☆   | 30                       | ±20                  | 11                 |                       | 9                            | 14.5  | —   | —     | 26                       | 1270                       | U-MOSIV    |
| TPC8030 ☆   | 30                       | ±25                  | 11                 |                       | 8.5                          | 17    | —   | —     | 24                       | 1140                       | U-MOSIV    |
| TPC8037-H ☆ | 30                       | ±20                  | 12                 |                       | 11.4                         | 13.9  | —   | —     | 11                       | 1433                       | U-MOSV-H   |
| TPC8038-H ☆ | 30                       | ±20                  | 12                 |                       | 11.4                         | 13.9  | —   | —     | 11                       | 1433                       | U-MOSV-H   |
| TPC8040-H ☆ | 30                       | ±20                  | 13                 |                       | 9.7                          | 11.1  | —   | —     | 12                       | 1700                       | U-MOSVI-H  |
| TPC8041 ☆   | 30                       | ±20                  | 13                 |                       | 7                            | 13.5  | —   | —     | 27                       | 1270                       | U-MOSIV    |
| TPC8026 ☆   | 30                       | ±20                  | 13                 |                       | 6.6                          | 10    | —   | —     | 42                       | 1800                       | U-MOSIV    |
| TPC8032-H ☆ | 30                       | ±20                  | 15                 |                       | 6.5                          | 8.6   | —   | —     | 17                       | 2270                       | U-MOSV-H   |
| TPC8039-H ☆ | 30                       | ±20                  | 17                 |                       | 5.7                          | 6.6   | —   | —     | 18                       | 2600                       | U-MOSVI-H  |
| TPC8033-H ☆ | 30                       | ±20                  | 17                 |                       | 5.3                          | 7.2   | —   | —     | 22                       | 2900                       | U-MOSV-H   |

☆: No protection Zener diode between gate and source



## ■ Product Offerings

| Part Number | Absolute Maximum Ratings |              |           | Circuit Configuration | $R_{DS(ON)}$ Max ( $m\Omega$ ) |       |      |       | $Q_g$ Typ. (nC) | $C_{iss}$ Typ. (pF) | Series      |
|-------------|--------------------------|--------------|-----------|-----------------------|--------------------------------|-------|------|-------|-----------------|---------------------|-------------|
|             | $V_{DSS}$ (V)            | $V_{GS}$ (V) | $I_D$ (A) |                       | 10 V                           | 4.5 V | 4 V  | 2.5 V |                 |                     |             |
| TPC8028 ☆   | 30                       | ±20          | 18        | N-ch Single           | 4.3                            | 8     | —    | —     | 45              | 1800                | U-MOSIV     |
| TPC8029 ☆   | 30                       | ±20          | 18        |                       | 3.8                            | 7     | —    | —     | 49              | 2200                | U-MOSIV     |
| TPC8036-H ☆ | 30                       | ±20          | 18        |                       | 4.5                            | 5.1   | —    | —     | 26              | 3500                | U-MOSVI-H   |
| TPC8034-H ☆ | 30                       | ±20          | 18        |                       | 3.5                            | 4.5   | —    | —     | 35              | 4614                | U-MOSV-H    |
| TPC8035-H ☆ | 30                       | ±20          | 18        |                       | 3.2                            | 3.6   | —    | —     | 44              | 6000                | U-MOSVI-H   |
| TPC8042 ☆   | 30                       | ±20          | 18        |                       | 3.4                            | 6.5   | —    | —     | 56              | 2900                | U-MOSIV     |
| TPC8027 ☆   | 30                       | ±20          | 18        |                       | 2.7                            | 5.5   | —    | —     | 113             | 4200                | U-MOSIV     |
| TPC8022-H   | 40                       | ±20          | 7.5       |                       | 27                             | 35    | —    | —     | 11              | 650                 | U-MOSIII-H  |
| TPC8052-H ☆ | 40                       | ±20          | 12        |                       | 11.5                           | 13.3  | —    | —     | 13              | 1620                | U-MOSVI-H   |
| TPC8047-H ☆ | 40                       | ±20          | 16        |                       | 7.6                            | 8.8   | —    | —     | 23              | 2590                | U-MOSVI-H   |
| TPC8046-H ☆ | 40                       | ±20          | 18        |                       | 5.7                            | 6.6   | —    | —     | 31              | 3545                | U-MOSVI-H   |
| TPC8045-H ☆ | 40                       | ±20          | 18        |                       | 3.9                            | 4.4   | —    | —     | 48              | 5800                | U-MOSVI-H   |
| TPC8053-H ☆ | 60                       | ±20          | 9         |                       | 22.5                           | 24.2  | —    | —     | 13              | 1620                | U-MOSVI-H   |
| TPC8050-H ☆ | 60                       | ±20          | 11        |                       | 14.5                           | 15.6  | —    | —     | 21              | 2590                | U-MOSVI-H   |
| TPC8049-H ☆ | 60                       | ±20          | 13        |                       | 10.7                           | 11.5  | —    | —     | 29              | 3545                | U-MOSVI-H   |
| TPC8048-H ☆ | 60                       | ±20          | 16        |                       | 6.9                            | 7.4   | —    | —     | 46              | 5800                | U-MOSVI-H   |
| TPC8051-H ☆ | 80                       | ±20          | 13        |                       | 9.7                            | 10.1  | —    | —     | 43              | 5800                | U-MOSVI-H   |
| TPC8012-H   | 200                      | ±20          | 1.8       |                       | 400                            | —     | —    | —     | 11              | 440                 | $\pi$ -MOSV |
| TPC8208     | 20                       | ±12          | 5         | N-ch Dual             | —                              | —     | 50   | 70    | 9.5             | 780                 | U-MOSIII    |
| TPC8207     | 20                       | ±12          | 6         |                       | —                              | —     | 20   | 30    | 22              | 2010                | U-MOSIII    |
| TPC8211     | 30                       | ±20          | 5.5       |                       | 36                             | 44    | —    | —     | 25              | 1250                | U-MOSIII    |
| TPC8212-H   | 30                       | ±20          | 6         |                       | 21                             | 27    | —    | —     | 16              | 840                 | U-MOSIII-H  |
| TPC8216-H ☆ | 30                       | ±20          | 6.4       |                       | 20                             | 23    | —    | —     | 7.6             | 900                 | U-MOSVI-H   |
| TPC8210     | 30                       | ±20          | 8         |                       | 15                             | 20    | —    | —     | 75              | 3530                | U-MOSIII    |
| TPC8218-H ☆ | 60                       | ±20          | 3.8       |                       | 57                             | 64    | —    | —     | 5.7             | 640                 | U-MOSVI-H   |
| TPC8213-H   | 60                       | ±20          | 5         |                       | 50                             | 56    | —    | —     | 6               | 625                 | U-MOSIII-H  |
| TPC8214-H   | 100                      | ±20          | 2.2       | 180                   | 190                            | —     | —    | 4.5   | 360             | U-MOSIII-H          |             |
| TPC8115     | -20                      | ±8           | -10       | P-ch Single           | —                              | 10    | —    | 14    | 115             | 9130                | U-MOSIV     |
| TPC8119 ☆   | -30                      | ±20          | -10       |                       | 13                             | —     | 28   | —     | 40              | 1560                | U-MOSV      |
| TPC8121 ☆   | -30                      | ±20          | -11       |                       | 12                             | —     | 24   | —     | 42              | 1770                | U-MOSV      |
| TPC8111     | -30                      | ±20          | -11       |                       | 12                             | —     | 18   | —     | 107             | 5710                | U-MOSIV     |
| TPC8113     | -30                      | ±20          | -11       |                       | 10                             | —     | 18   | —     | 107             | 4500                | U-MOSIV     |
| TPC8123 ☆   | -30                      | -25/+20      | -11       |                       | 9                              | 12.5  | —    | —     | 68              | 2940                | U-MOSVI     |
| TPC8122 ☆   | -30                      | ±20          | -12       |                       | 8                              | —     | 16.5 | —     | 62              | 2450                | U-MOSV      |
| TPC8118 ☆   | -30                      | ±20          | -13       |                       | 7                              | —     | 15   | —     | 65              | 2700                | U-MOSV      |
| TPC8114     | -30                      | ±20          | -18       |                       | 4.5                            | —     | 6.8  | —     | 180             | 7480                | U-MOSIV     |
| TPC8117 ☆   | -30                      | ±20          | -18       |                       | 3.9                            | —     | 7.9  | —     | 130             | 4600                | U-MOSV      |
| TPC8120 ☆   | -30                      | -25/+20      | -18       |                       | 3.2                            | 4.2   | —    | —     | 180             | 7420                | U-MOSVI     |
| TPC8116-H   | -40                      | ±20          | -7.5      |                       | 30                             | 37    | —    | —     | 27              | 1190                | U-MOSIII-H  |
| TPC8110     | -40                      | ±20          | -8        | 25                    | —                              | 35    | —    | 48    | 2180            | U-MOSIII            |             |
| TPC8405     | 30                       | ±20          | 6         | N-ch/P-ch Dual        | 26                             | 33    | —    | —     | 27              | 1240                | U-MOSIII    |
|             | -30                      | ±20          | -4.5      |                       | 33                             | 42    | —    | —     | 40              | 1540                | U-MOSIV     |
| TPC8406-H   | 40                       | ±20          | 6.5       |                       | 27                             | 35    | —    | —     | 11              | 650                 | U-MOSIII-H  |
|             | -40                      | ±20          | -6.5      |                       | 30                             | 37    | —    | —     | 27              | 1190                | U-MOSIII-H  |
| TPC8404     | 250                      | ±20          | 1.1       |                       | 1.7                            | —     | —    | —     | 10              | 267                 | $\pi$ -MOSV |
|             | -250                     | ±20          | -0.9      |                       | 2.55                           | —     | —    | —     | 12              | 381                 | $\pi$ -MOSV |
| TPC8A01     | 30                       | ±20          | 6         | N-ch/<br>N-ch + SBD   | 25                             | 30    | —    | —     | 17              | 940                 | U-MOSIII    |
|             | 30                       | ±20          | 8.5/1     |                       | 18                             | 21    | —    | —     | 49              | 2295                | U-MOSIII    |
| TPC8A05-H ☆ | 30                       | ±20          | 10/1      | MOSBD                 | 13.3                           | 17.6  | —    | —     | 7.4             | 1300                | U-MOSV-H    |
| TPC8A06-H ☆ | 30                       | ±20          | 12/1      |                       | 10.1                           | 12.9  | —    | —     | 9.6             | 1400                | U-MOSV-H    |
| TPC8A03-H ☆ | 30                       | ±20          | 17/1      |                       | 5.6                            | 7     | —    | —     | 19              | 2640                | U-MOSV-H    |
| TPC8A04-H ☆ | 30                       | ±20          | 18/1      |                       | 3.6                            | 4.5   | —    | —     | 29              | 4400                | U-MOSV-H    |

☆: No protection Zener diode between gate and source

## ● SOP Advance Series ... [Part Number: TPCA8xxx]

### ■ Features

- Low ON-resistance and high-speed-switching series are available.  
Low ON-resistance series: U-MOSIV/V  
High-speed-switching series: U-MOSIII-H, U-MOSV-H and U-MOSVI-H
- High-current, thin and thermally enhanced package

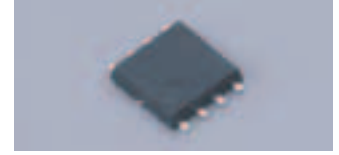

### ■ Product Offerings

| Part Number   | Absolute Maximum Ratings |                      |                    | Circuit Configuration | R <sub>DS(ON)</sub> Max (mΩ) |       |     |       |       | Q <sub>g</sub> Typ. (nC) | C <sub>iss</sub> Typ. (pF) | Series        |
|---------------|--------------------------|----------------------|--------------------|-----------------------|------------------------------|-------|-----|-------|-------|--------------------------|----------------------------|---------------|
|               | V <sub>DSS</sub> (V)     | V <sub>GSS</sub> (V) | I <sub>D</sub> (A) |                       | 10 V                         | 4.5 V | 4 V | 2.5 V | 1.8 V |                          |                            |               |
| TPCA8011-H    | 20                       | ±12                  | 40                 | N-ch Single           | —                            | 3.5   | —   | 7.5   | —     | 32                       | 2900                       | U-MOSIII-H    |
| TPCA8040-H ☆  | 30                       | ±20                  | 23                 |                       | 9.4                          | 10.8  | —   | —     | —     | 11.7                     | 1700                       | U-MOSVI-H     |
| TPCA8030-H ☆  | 30                       | ±20                  | 24                 |                       | 11.0                         | 13.4  | —   | —     | —     | 83                       | 1433                       | U-MOSV-H      |
| TPCA8031-H ☆  | 30                       | ±20                  | 24                 |                       | 11.0                         | 13.4  | —   | —     | —     | 83                       | 1433                       | U-MOSV-H      |
| TPCA8018-H ☆  | 30                       | ±20                  | 30                 |                       | 6.2                          | 8.2   | —   | —     | —     | 18                       | 2270                       | U-MOSV-H      |
| TPCA8039-H ☆  | 30                       | ±20                  | 34                 |                       | 5.7                          | 6.6   | —   | —     | —     | 19                       | 2600                       | U-MOSVI-H     |
| TPCA8024 ☆    | 30                       | ±20                  | 35                 |                       | 4.3                          | 7.8   | —   | —     | —     | 45                       | 1800                       | U-MOSIV       |
| TPCA8036-H ☆  | 30                       | ±20                  | 38                 |                       | 4.2                          | 4.8   | —   | —     | —     | 26                       | 3500                       | U-MOSVI-H     |
| TPCA8012-H ☆  | 30                       | ±20                  | 40                 |                       | 4.9                          | 6.8   | —   | —     | —     | 22                       | 2900                       | U-MOSV-H      |
| TPCA8025 ☆    | 30                       | ±20                  | 40                 |                       | 3.5                          | 6.0   | —   | —     | —     | 49                       | 2200                       | U-MOSIV       |
| TPCA8060-H ☆  | 30                       | ±20                  | 45                 |                       | 3.4                          | 3.9   | —   | —     | —     | 34                       | 4600                       | U-MOSVI-H     |
| TPCA8042 ☆    | 30                       | ±20                  | 45                 |                       | 3.3                          | 5.7   | —   | —     | —     | 56                       | 2900                       | U-MOSIV       |
| TPCA8019-H ☆  | 30                       | ±20                  | 45                 |                       | 3.1                          | 4.1   | —   | —     | —     | 34                       | 4614                       | U-MOSV-H      |
| TPCA8026 ☆    | 30                       | ±20                  | 45                 |                       | 2.2                          | 4.5   | —   | —     | —     | 113                      | 4200                       | U-MOSIV       |
| TPCA8028-H ☆  | 30                       | ±20                  | 50                 |                       | 2.8                          | 3.2   | —   | —     | —     | 46                       | 6000                       | U-MOSVI-H     |
| TPCA8020-H    | 40                       | ±20                  | 7.5                |                       | 27                           | 35    | —   | —     | —     | 11                       | 650                        | U-MOSIII-H    |
| TPCA8052-H ☆  | 40                       | ±20                  | 20                 |                       | 11.3                         | 13.1  | —   | —     | —     | 13                       | 1620                       | U-MOSVI-H     |
| TPCA8014-H    | 40                       | ±20                  | 30                 |                       | 9                            | 14    | —   | —     | —     | 22                       | 1365                       | U-MOSIII-H    |
| TPCA8027-H    | 40                       | ±20                  | 30                 |                       | 10                           | —     | —   | —     | —     | 23                       | 1430                       | U-MOSIII-H    |
| TPCA8047-H ☆  | 40                       | ±20                  | 32                 |                       | 7.3                          | 8.5   | —   | —     | —     | 23                       | 2590                       | U-MOSVI-H     |
| TPCA8015-H    | 40                       | ±20                  | 35                 |                       | 5.4                          | 7.9   | —   | —     | —     | 37                       | 2155                       | U-MOSIII-H    |
| TPCA8046-H ☆  | 40                       | ±20                  | 38                 |                       | 5.4                          | 6.3   | —   | —     | —     | 29                       | 3545                       | U-MOSVI-H     |
| TPCA8045-H ☆  | 40                       | ±20                  | 46                 |                       | 3.6                          | 4.1   | —   | —     | —     | 47                       | 5800                       | U-MOSVI-H     |
| TPCA8053-H ☆  | 60                       | ±20                  | 15                 |                       | 22.3                         | 24    | —   | —     | —     | 13                       | 1620                       | U-MOSVI-H     |
| TPCA8050-H ☆  | 60                       | ±20                  | 24                 |                       | 14.2                         | 15.3  | —   | —     | —     | 21                       | 2590                       | U-MOSVI-H     |
| TPCA8016-H    | 60                       | ±20                  | 25                 |                       | 21                           | 26    | —   | —     | —     | 22                       | 1375                       | U-MOSIII-H    |
| TPCA8049-H ☆  | 60                       | ±20                  | 28                 |                       | 10.4                         | 11.2  | —   | —     | —     | 29                       | 3545                       | U-MOSVI-H     |
| TPCA8048-H ☆  | 60                       | ±20                  | 35                 |                       | 6.6                          | 7.1   | —   | —     | —     | 46                       | 5800                       | U-MOSVI-H     |
| TPCA8051-H ☆  | 80                       | ±20                  | 28                 |                       | 9.4                          | 9.8   | —   | —     | —     | 47                       | 5800                       | U-MOSVI-H     |
| TPCA8006-H    | 100                      | ±20                  | 18                 |                       | 67                           | —     | —   | —     | —     | 12                       | 780                        | π-MOSVII      |
| TPCA8022-H    | 100                      | ±20                  | 22                 |                       | 26                           | —     | —   | —     | —     | 38                       | 2330                       | U-MOSIII-H    |
| TPCA8009-H    | 150                      | ±20                  | 7                  |                       | 350                          | —     | —   | —     | —     | 10                       | 600                        | π-MOSV MACHII |
| TPCA8010-H    | 200                      | ±20                  | 5.5                | 450                   | —                            | —     | —   | —     | 10    | 600                      | π-MOSV MACHII              |               |
| TPCA8008-H    | 250                      | ±20                  | 4                  | 580                   | —                            | —     | —   | —     | 10    | 600                      | π-MOSV MACHII              |               |
| TPCA8105      | -12                      | ±8                   | -6                 | —                     | 33                           | —     | 51  | 92    | 18    | 1600                     | U-MOSIV                    |               |
| TPCA8103      | -30                      | ±20                  | -40                | 4.2                   | —                            | 6.8   | —   | —     | 184   | 7880                     | U-MOSIV                    |               |
| TPCA8106 ☆    | -30                      | ±20                  | -40                | 3.7                   | —                            | 7.8   | —   | —     | 120   | 4600                     | U-MOSV                     |               |
| TPCA8107-H    | -40                      | ±20                  | -7.5               | 30                    | 37                           | —     | —   | —     | 27    | 1190                     | U-MOSIII-H                 |               |
| TPCA8108      | -40                      | ±20                  | -40                | 9.5                   | —                            | —     | —   | —     | 100   | 4820                     | U-MOSIII                   |               |
| TPCA8104      | -60                      | ±20                  | -40                | 16                    | —                            | 24    | —   | —     | 90    | 4300                     | U-MOSIII                   |               |
| TPCA8A05-H ☆  | 30                       | ±20                  | 10                 | 12.9                  | 17.2                         | —     | —   | —     | 7.4   | 1300                     | U-MOSV-H                   |               |
| TPCA8A02-H ☆  | 30                       | ±20                  | 34                 | 5.3                   | 6.7                          | —     | —   | —     | 19    | 2640                     | U-MOSV-H                   |               |
| TPCA8A08-H ☆  | 30                       | ±20                  | 38                 | 4.2                   | 5.3                          | —     | —   | —     | 24    | 3500                     | U-MOSV-H                   |               |
| TPCA8A04-H *☆ | 30                       | ±20                  | 42                 | 3.2                   | 4.1                          | —     | —   | —     | 30    | 4400                     | U-MOSV-H                   |               |

☆: No protection Zener diode between gate and source \*☆: Under development

## ● DPAK Series ... [Part Number: TKxxPxxxM1]

### ■ Features

- High-current, thermally enhanced package

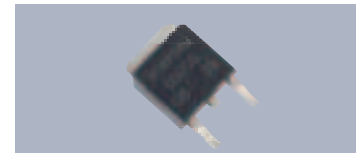

### ■ Product Offerings

| Part Number | Absolute Maximum Ratings |                      |                    | Circuit Configuration | R <sub>DS(ON)</sub> Max (mΩ) |       | Q <sub>g</sub> Typ. (nC) | C <sub>iss</sub> Typ. (pF) | Series    |
|-------------|--------------------------|----------------------|--------------------|-----------------------|------------------------------|-------|--------------------------|----------------------------|-----------|
|             | V <sub>DSS</sub> (V)     | V <sub>GSS</sub> (V) | I <sub>D</sub> (A) |                       | 10 V                         | 4.5 V |                          |                            |           |
| TK40P03M1 ☆ | 30                       | ±20                  | 40                 | N-ch Single           | 10.8                         | 14.4  | 9.4                      | 1150                       | U-MOSVI-H |
| TK50P03M1 ☆ | 30                       | ±20                  | 50                 |                       | 7.5                          | 9.8   | 13.3                     | 1700                       | U-MOSVI-H |
| TK40P04M1 ☆ | 40                       | ±20                  | 40                 |                       | 10.3                         | 13.4  | 29                       | 1920                       | U-MOSVI-H |
| TK50P04M1 ☆ | 40                       | ±20                  | 50                 |                       | 8.7                          | 10.2  | 38                       | 2600                       | U-MOSVI-H |

☆: No protection Zener diode between gate and source

## 4-7 Standard MOSFET Series ( $I_D < 500$ mA)

### Single MOSFETs

| Polarity | Absolute Maximum Ratings |               |            | Package                              |                                   |                         |                                   |                                    |                          | $V_{th}$ (V) | $R_{DS(ON)}$ Typ. (Max) ( $\Omega$ ) | $V_{GS}$ (V) |
|----------|--------------------------|---------------|------------|--------------------------------------|-----------------------------------|-------------------------|-----------------------------------|------------------------------------|--------------------------|--------------|--------------------------------------|--------------|
|          | $V_{DSS}$ (V)            | $V_{GSS}$ (V) | $I_D$ (mA) | S-Mini (SOT-346)<br>2925 size, 3-pin | USM (SOT-323)<br>2021 size, 3-pin | UFM<br>2021 size, 3-pin | SSM (SOT-416)<br>1616 size, 3-pin | VSEM (SOT-723)<br>1212 size, 3-pin | CST3<br>1006 size, 3-pin |              |                                      |              |
| N-ch     | 20                       | $\pm 10$      | 180        | —                                    | —                                 | —                       | SSM3K35FS                         | SSM3K35MFV                         | SSM3K35CT                | 0.4 to 1.0   | 5 (20)                               | 1.2          |
|          | 20                       | $\pm 10$      | 100        | —                                    | SSM3K16FU                         | —                       | SSM3K16FS                         | SSM3K16FV                          | SSM3K16CT                | 0.6 to 1.1   | 5.2 (15)                             | 1.5          |
|          | 20                       | $\pm 10$      | 500        | —                                    | —                                 | SSM3K36TU               | SSM3K36FS                         | SSM3K36MFV                         | —                        | 0.35 to 1.0  | 0.95 (1.52)                          | 1.5          |
|          | 20                       | $\pm 10$      | 500        | —                                    | —                                 | —                       | SSM3K43FS                         | —                                  | —                        | 0.35 to 1.0  | 0.95 (1.52)                          | 1.5          |
|          | 20                       | 10            | 100        | —                                    | —                                 | —                       | —                                 | SSM3K03FV                          | —                        | 0.7 to 1.3   | 4 (12)                               | 2.5          |
|          | 20                       | 10            | 100        | —                                    | **SSM3K04FU                       | —                       | **SSM3K04FS                       | **SSM3K04FV                        | —                        | 0.7 to 1.3   | 4 (12)                               | 2.5          |
|          | 20                       | $\pm 12$      | 400        | —                                    | SSM3K05FU                         | —                       | —                                 | —                                  | —                        | 0.6 to 1.1   | 0.85 (1.20)                          | 2.5          |
|          | 30                       | $\pm 20$      | 100        | SSM3K15F                             | SSM3K15FU                         | —                       | SSM3K15FS                         | SSM3K15FV                          | SSM3K15CT                | 0.8 to 1.5   | 4.0 (7.0)                            | 2.5          |
|          | 30                       | $\pm 20$      | 100        | —                                    | —                                 | —                       | SSM3K44FS                         | SSM3K44MFV                         | —                        | 0.8 to 1.5   | 4.0 (7.0)                            | 2.5          |
|          | 30                       | $\pm 20$      | 200        | 2SK2009                              | —                                 | —                       | —                                 | —                                  | —                        | 0.5 to 1.5   | 1.2 (2.0)                            | 2.5          |
|          | 30                       | $\pm 20$      | 400        | —                                    | SSM3K09FU                         | —                       | —                                 | —                                  | —                        | 1.1 to 1.8   | 0.8 (1.2)                            | 4.0          |
|          | 50                       | $\pm 7$       | 100        | —                                    | SSM3K17FU                         | —                       | —                                 | —                                  | —                        | 0.9 to 1.5   | 22 (40)                              | 2.5          |
|          | 60                       | $\pm 20$      | 200        | 2SK1062                              | —                                 | —                       | —                                 | —                                  | —                        | 2.0 to 3.5   | 0.6 (1.0)                            | 10           |
|          | 60                       | $\pm 20$      | 200        | SSM3K7002F                           | SSM3K7002FU                       | —                       | —                                 | —                                  | —                        | 1.0 to 2.5   | 2.2 (3.3)                            | 4.5          |
|          | 60                       | $\pm 20$      | 200        | SSM3K7002AF                          | SSM3K7002AFU                      | —                       | —                                 | —                                  | —                        | 1.0 to 2.5   | 1.8 (3.3)                            | 4.5          |
|          | 60                       | $\pm 20$      | 200        | SSM3K7002BF                          | SSM3K7002BFU                      | —                       | SSM3K7002BFS                      | —                                  | —                        | 1.5 to 3.1   | 2.1 (3.3)                            | 4.5          |
| P-ch     | -20                      | $\pm 10$      | -100       | —                                    | —                                 | —                       | SSM3J35FS                         | SSM3J35MFV                         | SSM3J35CT                | -0.4 to -1.0 | 11 (44)                              | -1.2         |
|          | -20                      | $\pm 10$      | -100       | —                                    | SSM3J16FU                         | —                       | SSM3J16FS                         | SSM3J16FV                          | SSM3J16CT                | -0.6 to -1.1 | 18 (45)                              | -1.5         |
|          | -20                      | $\pm 8$       | -330       | —                                    | —                                 | SSM3J36TU               | SSM3J36FS                         | SSM3J36MFV                         | —                        | -0.3 to -1.0 | 2.23 (3.6)                           | -1.5         |
|          | -20                      | $\pm 12$      | -200       | —                                    | SSM3J05FU                         | —                       | —                                 | —                                  | —                        | -0.6 to -1.1 | 3.2 (4.0)                            | -2.5         |
|          | -30                      | $\pm 20$      | -100       | SSM3J15F                             | SSM3J15FU                         | —                       | SSM3J15FS                         | SSM3J15FV                          | SSM3J15CT                | -1.1 to -1.7 | 14 (32)                              | -2.5         |
|          | -30                      | $\pm 20$      | -200       | 2SJ305                               | —                                 | —                       | —                                 | —                                  | —                        | -0.5 to -1.5 | 2.4 (4.0)                            | -2.5         |
|          | -30                      | $\pm 20$      | -200       | —                                    | SSM3J09FU                         | —                       | —                                 | —                                  | —                        | -1.1 to -1.8 | 3.3 (4.2)                            | -4.0         |
|          | -50                      | -7            | -50        | 2SJ343                               | 2SJ344                            | —                       | —                                 | —                                  | —                        | -0.8 to -2.5 | 20 (50)                              | -4.0         |
|          | -60                      | $\pm 20$      | -200       | 2SJ168                               | —                                 | —                       | —                                 | —                                  | —                        | -2.0 to -3.5 | 1.3 (2.0)                            | -10          |

\*\* : Built-in 1-M $\Omega$  gate-source resistor

### Dual MOSFETs

| Polarity      | Absolute Maximum Ratings |               |            | Package                           |                         |                                   |                                   |                                   | $V_{th}$ (V) | $R_{DS(ON)}$ Typ. (Max) ( $\Omega$ ) | $V_{GS}$ (V) | Constituent Devices |                           |
|---------------|--------------------------|---------------|------------|-----------------------------------|-------------------------|-----------------------------------|-----------------------------------|-----------------------------------|--------------|--------------------------------------|--------------|---------------------|---------------------------|
|               | $V_{DSS}$ (V)            | $V_{GSS}$ (V) | $I_D$ (mA) | US6 (SOT-363)<br>2021 size, 6-pin | UF6<br>2021 size, 6-pin | USV (SOT-353)<br>2021 size, 5-pin | ES6 (SOT-563)<br>1616 size, 6-pin | ESV (SOT-553)<br>1616 size, 5-pin |              |                                      |              |                     | CST6D<br>1009 size, 6-pin |
| N-chx2        | 20                       | $\pm 10$      | 180        | SSM6N35FU                         | —                       | —                                 | SSM6N35FE                         | —                                 | —            | 0.4 to 1.0                           | 5 (20)       | 1.2                 | SSM3K35FSx2               |
|               | 20                       | $\pm 10$      | 100        | SSM6N16FU                         | —                       | SSM5N16FU                         | SSM6N16FE                         | SSM5N16FE                         | —            | 0.6 to 1.1                           | 5.2 (15)     | 1.5                 | SSM3K16FUx2               |
|               | 20                       | $\pm 10$      | 250        | —                                 | —                       | —                                 | —                                 | —                                 | SSM6N37CTD   | 0.35 to 1.0                          | 3.07 (5.6)   | 1.5                 | —                         |
|               | 20                       | $\pm 10$      | 500        | —                                 | SSM6N36TU               | —                                 | SSM6N36FE                         | —                                 | —            | 0.35 to 1.0                          | 0.95 (1.52)  | 1.5                 | SSM3K36FSx2               |
|               | 20                       | $\pm 10$      | 500        | SSM6N43FU                         | —                       | —                                 | —                                 | —                                 | —            | 0.35 to 1.0                          | 0.95 (1.52)  | 1.5                 | SSM3K43FSx2               |
|               | 20                       | 10            | 100        | —                                 | —                       | —                                 | SSM6N03FE                         | SSM5N03FE                         | —            | 0.7 to 1.3                           | 4 (12)       | 2.5                 | SSM3K03FEx2               |
|               | 20                       | 10            | 100        | **SSM6N04FU                       | —                       | —                                 | —                                 | —                                 | —            | 0.7 to 1.3                           | 4 (12)       | 2.5                 | SSM3K04FUx2               |
|               | 20                       | $\pm 12$      | 400        | SSM6N05FU                         | —                       | SSM5N05FU                         | —                                 | —                                 | —            | 0.6 to 1.1                           | 0.85 (1.2)   | 2.5                 | SSM3K05FUx2               |
|               | 30                       | $\pm 20$      | 100        | SSM6N15FU                         | —                       | SSM5N15FU                         | SSM6N15FE                         | SSM5N15FE                         | —            | 0.8 to 1.5                           | 4.0 (7.0)    | 2.5                 | SSM3K15FUx2               |
|               | 30                       | $\pm 20$      | 100        | SSM6N44FU                         | —                       | —                                 | SSM6N44FE                         | —                                 | —            | 0.8 to 1.5                           | 4.0 (7.0)    | 2.5                 | SSM3K44FSx2               |
|               | 30                       | $\pm 20$      | 400        | SSM6N09FU                         | —                       | —                                 | —                                 | —                                 | —            | 1.1 to 1.8                           | 0.8 (1.2)    | 4.0                 | SSM3K09FUx2               |
|               | 50                       | $\pm 7$       | 100        | SSM6N17FU                         | —                       | —                                 | —                                 | —                                 | —            | 0.9 to 1.5                           | 22 (40)      | 2.5                 | SSM3K17FUx2               |
|               | 60                       | $\pm 20$      | 200        | SSM6N7002FU                       | —                       | —                                 | —                                 | —                                 | —            | 1.0 to 2.5                           | 2.2 (3.3)    | 4.5                 | SSM3K7002FUx2             |
|               | 60                       | $\pm 20$      | 200        | SSM6N7002AFU                      | —                       | —                                 | —                                 | —                                 | —            | 1.0 to 2.5                           | 1.8 (3.3)    | 4.5                 | SSM3K7002AFUx2            |
|               | 60                       | $\pm 20$      | 200        | SSM6N7002BFU                      | —                       | —                                 | —                                 | SSM6N7002BFE                      | —            | 1.5 to 3.1                           | 2.1 (3.3)    | 4.5                 | SSM3K7002BFUx2            |
|               | P-chx2                   | -20           | $\pm 10$   | -100                              | SSM6P35FU               | —                                 | —                                 | SSM6P35FE                         | —            | —                                    | -0.4 to -1.0 | 11 (44)             | -1.2                      |
| -20           |                          | $\pm 10$      | -100       | SSM6P16FU                         | —                       | SSM5P16FU                         | SSM6P16FE                         | SSM5P16FE                         | —            | -0.6 to -1.1                         | 18 (45)      | -1.5                | SSM3J16FUx2               |
| -20           |                          | $\pm 8$       | -330       | —                                 | SSM6P36TU               | —                                 | SSM6P36FE                         | —                                 | —            | -0.3 to -1.0                         | 2.23 (3.6)   | -1.5                | SSM3J36FSx2               |
| -20           |                          | $\pm 12$      | -200       | SSM6P05FU                         | —                       | SSM5P05FU                         | —                                 | —                                 | —            | -0.6 to -1.1                         | 3.2 (4.0)    | -2.5                | SSM3J05FUx2               |
| -30           |                          | $\pm 20$      | -100       | SSM6P15FU                         | —                       | SSM5P15FU                         | SSM6P15FE                         | SSM5P15FE                         | —            | -1.1 to -1.7                         | 14 (32)      | -2.5                | SSM3J15FUx2               |
| -30           |                          | $\pm 20$      | -200       | SSM6P09FU                         | —                       | —                                 | —                                 | —                                 | —            | -1.1 to -1.8                         | 3.3 (4.2)    | -4.0                | SSM3J09FUx2               |
| N-ch+<br>P-ch | 20                       | $\pm 10$      | 180        | —                                 | —                       | —                                 | SSM6L35FE                         | —                                 | —            | 0.4 to 1.0                           | 5 (20)       | 1.2                 | SSM3K35FS                 |
|               | -20                      | $\pm 10$      | -100       | SSM6L35FU                         | —                       | —                                 | —                                 | —                                 | —            | -0.4 to -1.0                         | 11 (44)      | -1.2                | +SSM3J35FS                |
|               | 20                       | $\pm 10$      | 100        | —                                 | —                       | —                                 | SSM6L16FE                         | —                                 | —            | 0.6 to 1.1                           | 5.2 (15)     | 1.5                 | SSM3K16FS                 |
|               | -20                      | $\pm 10$      | -100       | —                                 | —                       | —                                 | —                                 | —                                 | —            | -0.6 to -1.1                         | 18 (45)      | -1.5                | +SSM3J16FS                |
|               | 20                       | $\pm 10$      | 500        | —                                 | SSM6L36TU               | —                                 | SSM6L36FE                         | —                                 | —            | 0.35 to 1.0                          | 0.95 (1.52)  | 1.5                 | SSM3K36FS                 |
|               | -20                      | $\pm 8$       | -330       | —                                 | —                       | —                                 | —                                 | —                                 | —            | -0.3 to -1.0                         | 2.23 (3.6)   | -1.5                | +SSM3J36FS                |
|               | 20                       | $\pm 12$      | 400        | SSM6L05FU                         | —                       | —                                 | —                                 | —                                 | —            | 0.6 to 1.1                           | 0.85 (1.2)   | 2.5                 | SSM3K05FU                 |
|               | -20                      | $\pm 12$      | -200       | —                                 | —                       | —                                 | —                                 | —                                 | —            | -0.6 to -1.1                         | 3.2 (4.0)    | -2.5                | +SSM3J05FU                |
| 30            | $\pm 20$                 | 400           | SSM6L09FU  | —                                 | —                       | —                                 | —                                 | —                                 | 1.1 to 1.8   | 0.8 (1.2)                            | 4.0          | SSM3K09FU           |                           |
| -30           | $\pm 20$                 | -200          | —          | —                                 | —                       | —                                 | —                                 | —                                 | -1.1 to -1.8 | 3.3 (4.2)                            | -4.0         | +SSM3J09FU          |                           |

\*\* : Built-in 1-M $\Omega$  gate-source resistor

## 5-1 TO-220SM(W) Series

The TO-220SM(W) package, which uses Cu connectors and a wide source terminal, realizes low ON-resistance and a high current-carrying capability.

#### ■ Features

- Achieves low ON-resistance, low package inductance and low thermal resistance due to the use of Cu connectors.
- Achieves a high current-carrying capability due to the use of a wide source terminal ( $I_D$  (DC) = 150 A max)
- AEC-Q101-qualified at a channel temperature ( $T_{ch}$ ) of 175°C
- Thin package: 3.7-mm (max) thick, much thinner than the previous TO-220SM package with a thickness of 4.7 mm (max)

#### ■ Characteristics of the WARP Series

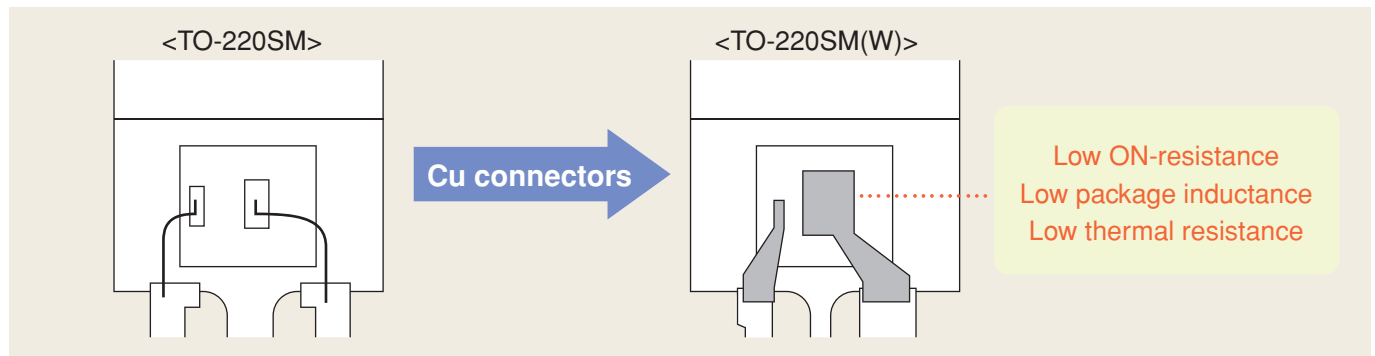

#### ■ Package

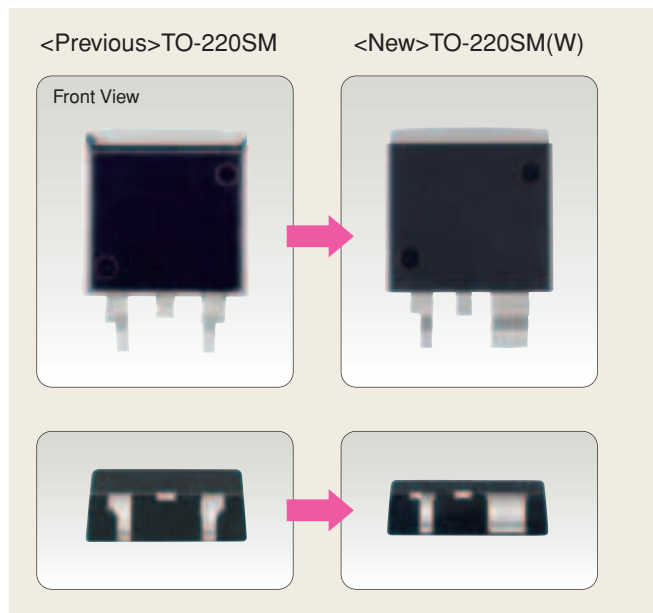

#### ■ Comparison of the Source Lead Temperature

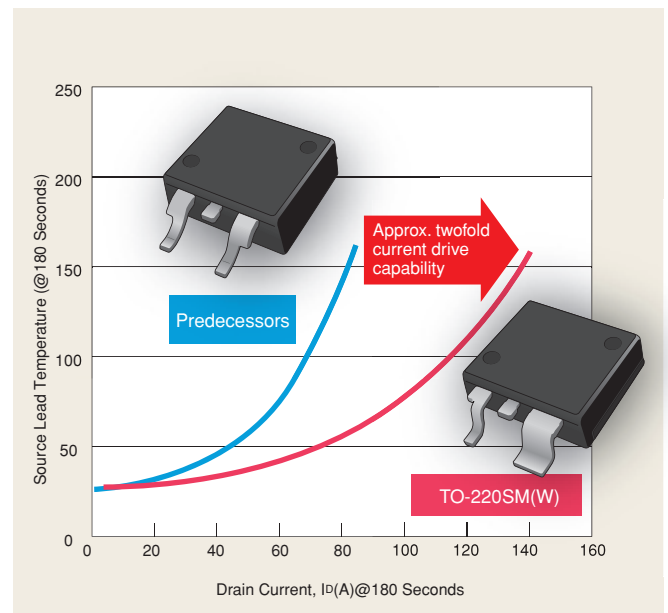

#### ■ Product Offerings

| Part Number | Absolute Maximum Ratings |              |           | $R_{DS(ON)}$ Max (m $\Omega$ ) |                | $C_{iss}$ Typ. (pF) | $Q_g$ Typ. (nC) | Series   |
|-------------|--------------------------|--------------|-----------|--------------------------------|----------------|---------------------|-----------------|----------|
|             | $V_{DSS}$ (V)            | $V_{GS}$ (V) | $I_D$ (A) | $V_{GS} = 10$ V                | $V_{GS} = 6$ V |                     |                 |          |
| TJ120F06J3  | -60                      | $\pm 20$     | -120      | 8                              | —              | 11500               | 258             | U-MOSIII |
| TK100F04K3  | 40                       | $\pm 20$     | 100       | 3                              | —              | 4500                | 102             | U-MOSIV  |
| TK100F04K3L | 40                       | $\pm 20$     | 100       | 3                              | 4.5            | 4980                | 105             | U-MOSIV  |
| TK150F04K3  | 40                       | $\pm 20$     | 150       | 2.1                            | —              | 7500                | 166             | U-MOSIV  |
| TK150F04K3L | 40                       | $\pm 20$     | 150       | 2.1                            | 3.2            | 9400                | 190             | U-MOSIV  |
| TK100F06K3  | 60                       | $\pm 20$     | 100       | 5                              | —              | 4500                | 98              | U-MOSIV  |
| TK130F06K3  | 60                       | $\pm 20$     | 130       | 3.4                            | —              | 8400                | 170             | U-MOSIV  |
| TK50F15J1   | 150                      | $\pm 20$     | 50        | 30                             | —              | 4300                | 75              | U-MOSIII |

## 5-2 U-MOS (Trench Type) Series

Fabricated using a trench structure, the U-MOS Series ultra-high integration density and thus

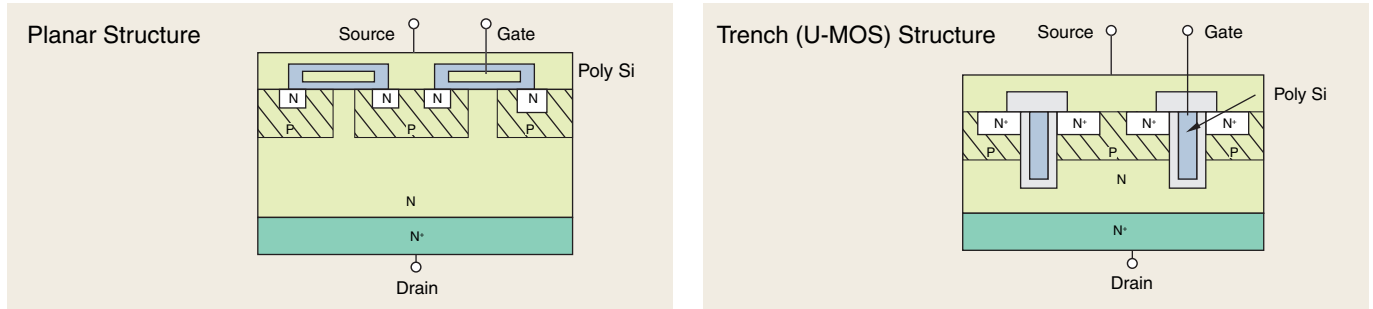

### ■ Features

- High density through the use of submicron technology
- 60% reduction in  $R_{DS(ON)}$  by per unit area (as compared with the maximum  $R_{DS(ON)}$  of  $L^2$ - $\pi$ -MOSV)
- Guaranteed avalanche capability and improved di/dt rate

### ■ Product Offerings

| Applications   | Part Number | Absolute Maximum Ratings |              |           |           | Package      | $R_{DS(ON)}$ Max (m $\Omega$ ) |      |       |     | $Q_g$ Typ. (nC) | Series   |          |
|--|-------------|--------------------------|--------------|-----------|-----------|--------------|--------------------------------|------|-------|-----|-----------------|----------|----------|
|  |             | $V_{DS}$ (V)             | $V_{GS}$ (V) | $I_D$ (A) | $P_D$ (W) |              | 10 V                           | 6 V  | 4.5 V | 4 V |                 |          |          |
| motor drive<br>Solenoids<br>Lamp drivers<br>DC-DC converters | 2SJ668      | -60                      | $\pm 20$     | -5        | 20        | PW-Mold      | 170                            | —    | —     | 250 | 15              | U-MOSIII |          |
|  | 2SJ681      | -60                      | $\pm 20$     | -5        | 20        | New PW-Mold2 | 170                            | —    | —     | 250 | 15              |          |          |
|  | 2SJ669      | -60                      | $\pm 20$     | -5        | 1.2       | TPS          | 170                            | —    | —     | 250 | 15              |          |          |
|  | TPCA8104    | -60                      | $\pm 20$     | -40       | 45        | SOP Advance  | 16                             | —    | —     | 24  | 90              |          |          |
|  | TJ70A06J3   | -60                      | $\pm 20$     | -70       | 54        | TO-220SIS    | 8.0                            | —    | 10    | —   | 246             |          |          |
|  | TJ120F06J3  | -60                      | $\pm 20$     | -120      | 300       | TO-220SM(W)  | 8.0                            | —    | —     | —   | 258             |          |          |
| LCD backlight inverter                                       | TJ20A10M3 ☆ | -100                     | $\pm 20$     | -20       | 35        | TO-220SIS    | 90                             | —    | —     | —   | 120             | U-MOSVI  |          |
| motor drive<br>Solenoids<br>Lamp drivers<br>DC-DC converters | 2SK3754     | 30                       | $\pm 20$     | 5         | 25        | TO-220NIS    | 89                             | —    | 99    | —   | 2.5             | U-MOSIII |          |
|  | 2SK3846     | 40                       | $\pm 20$     | 26        | 25        | TO-220NIS    | 16                             | —    | 28    | —   | 40              |          |          |
|  | 2SK3847     | 40                       | $\pm 20$     | 32        | 30        | TO-220SM     | 16                             | —    | 28    | —   | 40              |          |          |
|  | TK70J04J3   | 40                       | $\pm 20$     | 70        | 150       | TO-3P(N)     | 3.8                            | —    | 8.3   | —   | 210             |          |          |
|  | TK70X04K3 ☆ | 40                       | $\pm 20$     | 70        | 80        | TFP          | 5.6                            | —    | —     | —   | 62              |          |          |
|  |             | TK70X04K3Z               | 40           | $\pm 20$  | 70        | 80           | TFP                            | 5.6  | —     | —   | —               | 62       | U-MOSIV  |
|  |             | 2SK3843                  | 40           | $\pm 20$  | 75        | 125          | TFP                            | 3.5  | —     | 8.0 | —               | 210      | U-MOSIII |
|  |             | TK80X04K3 ☆              | 40           | $\pm 20$  | 80        | 125          | TFP                            | 3.5  | —     | —   | —               | 100      |          |
|  |             | TK100F04K3 ☆             | 40           | $\pm 20$  | 100       | 200          | TO-220SM(W)                    | 3.0  | —     | —   | —               | 102      |          |
|  |             | TK100F04K3L              | 40           | $\pm 20$  | 100       | 200          | TO-220SM(W)                    | 3.0  | 4.5   | —   | —               | 105      | U-MOSIV  |
|  |             | TK150F04K3 ☆             | 40           | $\pm 20$  | 150       | 300          | TO-220SM(W)                    | 2.1  | —     | —   | —               | 166      |          |
|  |             | TK150F04K3L              | 40           | $\pm 20$  | 150       | 300          | TO-220SM(W)                    | 2.1  | 3.2   | —   | —               | 190      |          |
|  |             | 2SK4017                  | 60           | $\pm 20$  | 5         | 20           | New PW-Mold2                   | 100  | —     | —   | 150             | 15       |          |
|  |             | 2SK4033                  | 60           | $\pm 20$  | 5         | 20           | New PW-Mold                    | 100  | —     | —   | 150             | 15       |          |
|  |             | TK30A06J3A               | 60           | $\pm 20$  | 30        | 25           | TO-220SIS                      | 26   | —     | 35  | —               | 36       | U-MOSIII |
|  |             | 2SK3662                  | 60           | $\pm 20$  | 35        | 35           | TO-220NIS                      | 12.5 | —     | —   | 19              | 91       |          |
|  |             | 2SK3844                  | 60           | $\pm 20$  | 45        | 45           | TO-220NIS                      | 5.8  | —     | —   | —               | 196      |          |
|  |             | TK70X06K3 ☆              | 60           | $\pm 20$  | 70        | 80           | TFP                            | 8.0  | —     | —   | —               | 62       | U-MOSIV  |
|  |             | 2SK3845                  | 60           | $\pm 20$  | 70        | 125          | TO-3P(N)                       | 5.8  | —     | —   | —               | 196      |          |
|  |             | 2SK3842                  | 60           | $\pm 20$  | 75        | 125          | TFP                            | 5.8  | —     | —   | —               | 196      | U-MOSIII |
|  | 2SK4034     | 60                       | $\pm 20$     | 75        | 125       | TFP          | 5.8                            | —    | 10    | —   | 196             |          |          |
|  | 2SK3940     | 75                       | $\pm 20$     | 70        | 150       | TO-3P(N)     | 7.0                            | —    | —     | —   | 200             | U-MOSIII |          |
| LCD backlight inverter                                       | TK25A10K3 ☆ | 100                      | $\pm 20$     | 25        | 25        | TO-220SIS    | 40                             | —    | —     | —   | 34              | U-MOSIV  |          |
|  | TK40X10J1   | 100                      | $\pm 20$     | 40        | 125       | TFP          | 20                             | —    | —     | —   | 59              | U-MOSIII |          |
|  | TK50F15J1   | 150                      | $\pm 20$     | 50        | 300       | TO-220SM(W)  | 30                             | —    | —     | —   | 75              |          |          |

☆: No protection Zener diode between gate and source

## 5-3 U-MOS Series for Synchronous Rectification ( $V_{DS} = 60\text{ V to }150\text{ V}$ )

### ■ Features

- Low ON-resistance achieved by high density through the use of submicron technology
- Guaranteed avalanche capability
- High power dissipation achieved by having the series housed in the TO-220(W) package with an exposed heatsink on the bottom of the package

### ■ Comparisons Between Synchronous Rectification MOSFETs

| Characteristic                 | Symbol        | Test Conditions  | TK80A08K3 |      |      | TK60A08J1 |      |      | Unit             |
|--------------------------------|---------------|--|-----------|------|------|-----------|------|------|------------------|
|                                |               |  | Min       | Typ. | Max  | Min       | Typ. | Max  |                  |
| Gate leakage current           | +IGSS         | $V_{GS}$ condition*, $V_{DS} = 0\text{ V}$                           | —         | —    | 1    | —         | —    | 10   | $\mu\text{A}$    |
|                                | -IGSS         | $V_{GS}$ condition*, $V_{DS} = 0\text{ V}$                           | —         | —    | -1   | —         | —    | -10  | $\mu\text{A}$    |
| Drain cut-off current          | IGSS          | $V_{DS} = 75\text{ V}$ , $V_{GS} = 0\text{ V}$                       | —         | —    | 10   | —         | —    | 10   | $\mu\text{A}$    |
| Drain-source breakdown voltage | $V_{(BR)DSS}$ | $I_D = 10\text{ mA}$ , $V_{GS} = 0\text{ V}$                         | 75        | —    | —    | 75        | —    | —    | V                |
|                                | $V_{(BR)DSX}$ | $I_D = 10\text{ mA}$ , $V_{GS} = -20\text{ V}$                       | 50        | —    | —    | 60        | —    | —    | V                |
| Gate threshold voltage         | $V_{th}$      | $V_{DS} = 10\text{ V}$ , $I_D = 1\text{ mA}$                         | 2.0       | —    | 4.0  | 1.1       | —    | 2.3  | V                |
| Drain-source ON-resistance     | $R_{DS(ON)}$  | $V_{GS} = 10\text{ V}$ , $I_D = 40\text{ A}$                         | —         | 3.6  | 4.5  | —         | 6.2  | 7.8  | $\text{m}\Omega$ |
| Input capacitance              | $C_{iss}$     | $V_{DS} = 10\text{ V}$ , $V_{GS} = 0\text{ V}$<br>$f = 1\text{ MHz}$ | —         | 8200 | —    | —         | 5450 | —    | pF               |
| Reverse transfer capacitance   | $C_{rss}$     |  | —         | 770  | —    | —         | 320  | —    | pF               |
| Forward voltage                | $V_{DSF}$     | $I_{DR} = 80\text{ A}$ , $V_{GS} = 0\text{ V}$                       | —         | -0.9 | -1.2 | —         | -0.9 | -1.2 | V                |

\*: Test conditions: TK80A08K3:  $V_{GS} = \pm 20\text{ V}$ , TK60A08J1:  $V_{GS} = \pm 16\text{ V}$

### ■ Efficiency Test Circuit

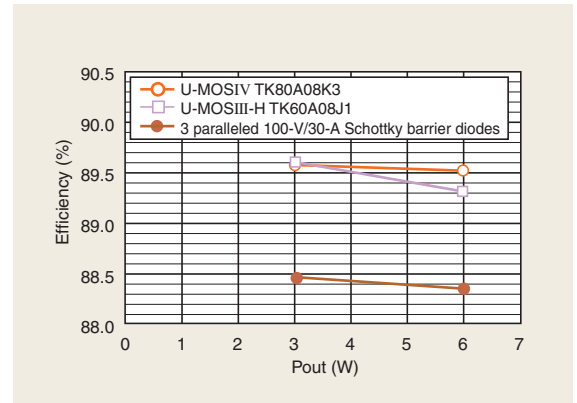
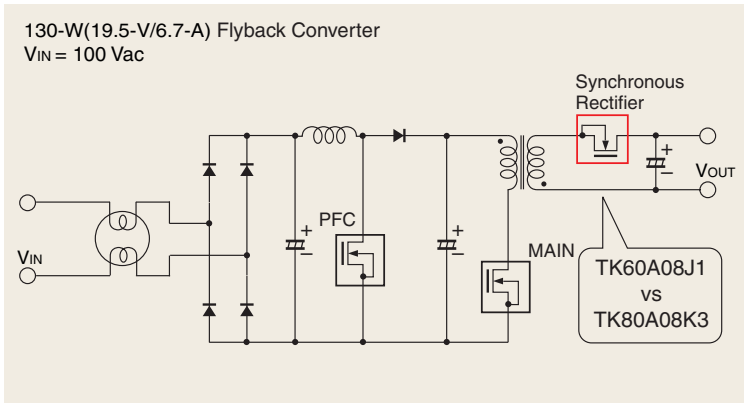

Efficiency approx. 1% higher than Schottky barrier diodes

### ■ Product Offerings

| Part Number | Absolute Maximum Ratings |              |           |           | $R_{DS(ON)}$ ( $\text{m}\Omega$ ) @ $V_{GS} = 10\text{ V}$ |      | $Q_g$ (nC) Typ. | $Q_{sw}$ (nC) Typ. | Package   | Series     |
|-------------|--------------------------|--------------|-----------|-----------|--|------|-----------------|--------------------|-----------|------------|
|             | $V_{DS}$ (V)             | $V_{GS}$ (V) | $I_D$ (A) | $P_D$ (W) | Typ.   | Max  |                 |                    |           |            |
| TK70D06J1   | 60                       | $\pm 20$     | 70        | 140       | 5.1  | 6.4  | 87              | 30                 | TO-220(W) | U-MOSIII-H |
| TK70A06J1   | 60                       | $\pm 20$     | 70        | 45        | 5.1  | 6.4  | 87              | 30                 | TO-220SIS | U-MOSIII-H |
| TK60D08J1   | 75                       | $\pm 20$     | 60        | 140       | 6.2  | 7.8  | 86              | 27                 | TO-220(W) | U-MOSIII-H |
| TK60A08J1   | 75                       | $\pm 20$     | 60        | 45        | 6.2  | 7.8  | 86              | 27                 | TO-220SIS | U-MOSIII-H |
| TK40A08K3   | 75                       | $\pm 20$     | 40        | 42        | 7.0  | 9.0  | 80              | —                  | TO-220SIS | U-MOSIV    |
| TK80D08K3   | 75                       | $\pm 20$     | 80        | 100       | 3.6  | 4.5  | 175             | 80                 | TO-220(W) | U-MOSIV    |
| TK80A08K3   | 75                       | $\pm 20$     | 80        | 40        | 3.6  | 4.5  | 175             | 80                 | TO-220SIS | U-MOSIV    |
| TK40A10K3   | 100                      | $\pm 20$     | 40        | 40        | 11.5   | 15   | 85              | 40                 | TO-220SIS | U-MOSIV    |
| TK40D10J1   | 100                      | $\pm 20$     | 40        | 100       | 11.5   | 15   | 76              | 25                 | TO-220(W) | U-MOSIII-H |
| TK40A10J1   | 100                      | $\pm 20$     | 40        | 40        | 11.5   | 15   | 76              | 25                 | TO-220SIS | U-MOSIII-H |
| TK40X10J1   | 100                      | $\pm 20$     | 40        | 125       | 15   | 20   | 59              | 25                 | TFP       | U-MOSIII-H |
| TK55D10J1   | 100                      | $\pm 20$     | 55        | 140       | 8.4  | 10.5 | 110             | 33                 | TO-220(W) | U-MOSIII-H |
| TK55A10J1   | 100                      | $\pm 20$     | 55        | 45        | 8.4  | 10.5 | 110             | 33                 | TO-220SIS | U-MOSIII-H |
| TK50X15J1   | 150                      | $\pm 20$     | 50        | 125       | 22   | 30   | 75              | 33                 | TFP       | U-MOSIII-H |

## 6-1 $\pi$ -MOSVII Series ( $V_{DSS} = 450\text{ V to }650\text{ V}$ )

The latest addition to the  $\pi$ -MOS portfolio, the  $\pi$ -MOSVII Series offers reduced capacitances due to optimized chip design and is available with a greatly wider range of electrical characteristics.

### ■ Features

- 40% reduction in  $Q_g$  from  $\pi$ -MOSVI due to optimized chip design
- Available in 50-V steps of  $V_{DSS}$  and in finer steps of  $R_{DS(ON)}$ .
- Rated avalanche and reverse recovery current capabilities

### ■ Performance Comparisons Between $\pi$ -MOSVII and $\pi$ -MOSVI Devices (600 V/10 A)

| Characteristic                 | Symbol        | Test Conditions  | $\pi$ -MOSVII |           |         | $\pi$ -MOSVI |      |          | Unit          |
|--------------------------------|---------------|--|---------------|-----------|---------|--------------|------|----------|---------------|
|                                |               |  | Min           | Typ.      | Max     | Min          | Typ. | Max      |               |
| Gate leakage current           | $\pm I_{GSS}$ | $V_{GS}$ condition*, $V_{DS} = 0\text{ V}$                       | —             | —         | $\pm 1$ | —            | —    | $\pm 10$ | $\mu\text{A}$ |
| Drain cut-off current          | $I_{DSS}$     | $V_{DS} = 600\text{ V}, V_{GS} = 0\text{ V}$                     | —             | —         | 100     | —            | —    | 100      | $\mu\text{A}$ |
| Drain-source breakdown voltage | $V_{(BR)DSS}$ | $I_D = +10\text{ mA}, V_{GS} = 0\text{ V}$                       | 600           | —         | —       | 600          | —    | —        | V             |
| Gate threshold voltage         | $V_{th}$      | $V_{DS} = 10\text{ V}, I_D = 1\text{ mA}$                        | 2.0           | —         | 4.0     | 2.0          | —    | 4.0      | V             |
| Drain-source ON-resistance     | $R_{DS(ON)}$  | $V_{GS} = 10\text{ V}, I_D = 5\text{ A}$                         | —             | —         | 0.75    | —            | —    | 0.75     | $\Omega$      |
| Total gate charge              | $Q_g$         | $V_{DD} = 400\text{ V}, V_{GS} = 10\text{ V}, I_D = 10\text{ A}$ | —             | <b>25</b> | —       | —            | 42   | —        | nC            |
| Diode forward voltage          | $V_{DSF}$     | $I_{DR} = 10\text{ A}, V_{GS} = 0\text{ V}$                      | —             | —         | -1.7    | —            | —    | -1.7     | V             |

\*: Test conditions: TK10A60D:  $V_{GS} = \pm 30\text{ V}$ , 2SK3569:  $V_{GS} = \pm 25\text{ V}$

### ■ Efficiency Test Circuit

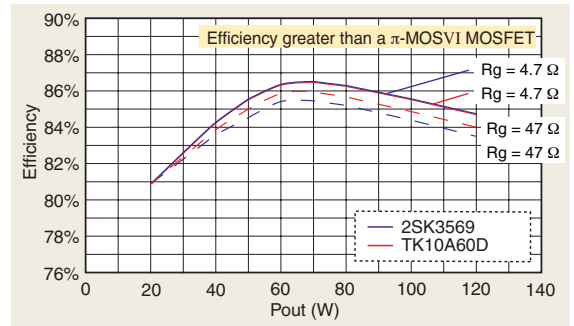
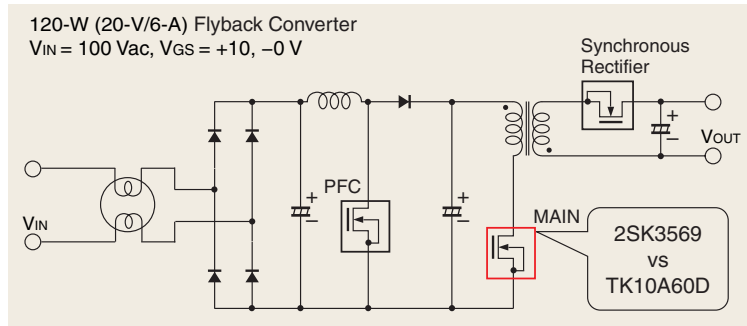

### ■ Product Offerings

| Part Number | Absolute Maximum Ratings |           | $R_{DS(ON)}$ ( $\Omega$ ) | Equivalent $\pi$ -MOSVI Part | Package   |           |
|-------------|--------------------------|-----------|---------------------------|------------------------------|-----------|-----------|
|             | $V_{DSS}$ (V)            | $I_D$ (A) |                           |                              |           |           |
| TK13A45D    | 450                      | 13        | 0.46                      | 2SK3743                      | TO-220SIS |           |
| TK4A50D     |                          | 4         | 2.0                       | —                            | TO-220SIS |           |
| TK5A50D     |                          | 5         | 1.5                       | 2SK3563                      | TO-220SIS |           |
| TK6A50D     |                          | 6         | 1.4                       | —                            | TO-220SIS |           |
| TK7A50D     |                          | 7         | 1.2                       | —                            | TO-220SIS |           |
| TK8A50DA    |                          | 7.5       | 1.0                       | —                            | TO-220SIS |           |
| TK8A50D     |                          | 8         | 0.85                      | 2SK3561                      | TO-220SIS |           |
| TK10A50D    |                          | 10        | 0.72                      | —                            | TO-220SIS |           |
| TK11A50D    |                          | 500       | 11                        | 0.6                          | —         | TO-220SIS |
| TK12A50D    |                          |           | 12                        | 0.52                         | 2SK3568   | TO-220SIS |
| TK13A50DA   |                          |           | 12.5                      | 0.47                         | —         | TO-220SIS |
| TK13A50D    |                          |           | 13                        | 0.4                          | 2SK4012   | TO-220SIS |
| TK15J50D    |                          |           | 15                        | 0.4                          | 2SK4107   | TO-3P(N)  |
| TK15A50D    |                          |           | 15                        | 0.3                          | 2SK3934   | TO-220SIS |
| TK18A50D    | 18                       |           | 0.27                      | —                            | TO-220SIS |           |
| TK20J50D    | 20                       |           | 0.27                      | 2SK4108                      | TO-3P(N)  |           |
| TK4A53D     | 525                      |           | 4                         | 1.7                          | —         | TO-220SIS |
| TK5A53D     |                          |           | 5                         | 1.5                          | 2SK3563   | TO-220SIS |
| TK6A53D     |                          | 6         | 1.3                       | —                            | TO-220SIS |           |
| TK6P53D     |                          | 6         | 1.3                       | —                            | D-PAK     |           |
| TK12A53D    |                          | 12        | 0.58                      | —                            | TO-220SIS |           |
| TK12X53D    |                          | 12        | 0.58                      | 2SK3398                      | TFP       |           |
| TK4A55DA    | 550                      | 3.5       | 2.45                      | —                            | TO-220SIS |           |
| TK4A55D     |                          | 4         | 1.9                       | —                            | TO-220SIS |           |
| TK5A55D     |                          | 5         | 1.7                       | —                            | TO-220SIS |           |
| TK6A55DA    |                          | 5.5       | 1.48                      | —                            | TO-220SIS |           |

| Part Number | Absolute Maximum Ratings |           | $R_{DS(ON)}$ ( $\Omega$ ) | Equivalent $\pi$ -MOSVI Part | Package   |               |
|-------------|--------------------------|-----------|---------------------------|------------------------------|-----------|---------------|
|             | $V_{DSS}$ (V)            | $I_D$ (A) |                           |                              |           |               |
| TK8A55DA    | 550                      | 7.5       | 1.07                      | —                            | TO-220SIS |               |
| TK9A55DA    |                          | 8.5       | 0.86                      | —                            | TO-220SIS |               |
| TK11A55D    |                          | 11        | 0.63                      | —                            | TO-220SIS |               |
| TK12A55D    |                          | 12        | 0.57                      | —                            | TO-220SIS |               |
| TK12J55D    |                          | 12        | 0.57                      | —                            | TO-3P(N)  |               |
| TK13A55DA   |                          | 12.5      | 0.48                      | —                            | TO-220SIS |               |
| TK14A55D    |                          | 14        | 0.37                      | —                            | TO-220SIS |               |
| TK16A55D *  |                          | 16        | 0.33                      | —                            | TO-220SIS |               |
| TK16J55D    |                          | 16        | 0.37                      | —                            | TO-3P(N)  |               |
| TK2Q60D     |                          | 600       | 2                         | 5.0                          | 2SK4002   | New PW-Mold 2 |
| TK3A60DA    |                          |           | 2.5                       | 2.8                          | —         | TO-220SIS     |
| TK4A60DA    |                          |           | 3.5                       | 2.2                          | 2SK3567   | TO-220SIS     |
| TK4A60DB    |                          |           | 3.7                       | 2                            | —         | TO-220SIS     |
| TK4A60D     |                          |           | 4                         | 1.7                          | —         | TO-220SIS     |
| TK6A60D     |                          |           | 6                         | 1.25                         | 2SK3562   | TO-220SIS     |
| TK8A60DA    |                          |           | 7.5                       | 1                            | 2SK3667   | TO-220SIS     |
| TK10A60D    | 10                       |           | 0.75                      | 2SK3569                      | TO-220SIS |               |
| TK11A60D    | 11                       |           | 0.65                      | —                            | TO-220SIS |               |
| TK12A60D    | 12                       |           | 0.55                      | —                            | TO-220SIS |               |
| TK13A60D    | 13                       | 0.43      | 2SK3797                   | TO-220SIS                    |           |               |
| TK15A60D    | 15                       | 0.37      | —                         | TO-220SIS                    |           |               |
| TK5A65D     | 650                      | 5         | 1.43                      | —                            | TO-220SIS |               |
| TK6A65D     |                          | 6         | 1.11                      | —                            | TO-220SIS |               |
| TK8A65D     |                          | 8         | 0.84                      | —                            | TO-220SIS |               |
| TK12A65D *  |                          | 12        | 0.50                      | —                            | TO-220SIS |               |

\*: Under development

## 6-2 Super-Junction DT MOS Series ( $V_{DSS} = 600\text{ V}, 650\text{ V}$ )

The DT MOS devices employ a new super-junction structure that enables an ultra-low ON-resistance with the maximum  $V_{DSS}$  rating of 600 V. The DT MOS Series helps reduce the power consumption and size of electronic equipment.

### ■ Features

- Low ON-resistance TK40J60T:  $80\text{ m}\Omega$  (max) @  $V_{GS} = 10\text{ V}, I_D = 20\text{ A}$
- Low gate charge TK20A60U:  $Q_g = 27\text{ nC}$  typ.,  $600\text{ V} / 20\text{ A}$
- The rugged internal drain-source diode is not damaged at  $di/dt = 500\text{ A}/\mu\text{s}$  ( $@V_{DS} = 400\text{ V}, 150^\circ\text{C}$ ).

### ■ Product Offerings

| Part Number | Absolute Maximum Ratings |           | $R_{DS(ON)}$ Max ( $\Omega$ ) | $Q_g$ Typ. (nC) | $C_{iss}$ Typ. (pF) | Package   | Series  |
|-------------|--------------------------|-----------|-------------------------------|-----------------|---------------------|-----------|---------|
|             | $V_{DSS}$ (V)            | $I_D$ (A) | $V_{GS} = 10\text{ V}$        |                 |                     |           |         |
| TK12A60U    | 600                      | 12        | 0.4                           | 14              | 720                 | TO-220SIS | DTMOSII |
| TK12D60U    |                          |           |                               |                 |                     | TO-220(W) |         |
| TK12J60U    |                          |           |                               |                 |                     | TO-3P(N)  |         |
| TK15J60T    |                          | 15        | 0.3                           | 21              | 1200                | TO-3P(N)  | DTMOSI  |
| TK15A60U    |                          | 15        | 0.3                           | 17              | 950                 | TO-220SIS | DTMOSII |
| TK15D60U    |                          |           |                               |                 |                     | TO-220(W) |         |
| TK15J60U    |                          |           |                               |                 |                     | TO-3P(N)  |         |
| TK20A60T    |                          | 20        | 0.19                          | 30              | 1580                | TO-220SIS | DTMOSI  |
| TK20D60T    |                          |           |                               |                 |                     | TO-220(W) |         |
| TK20J60T    |                          |           |                               |                 |                     | TO-3P(N)  |         |
| TK20A60U    |                          | 20        | 0.19                          | 27              | 1470                | TO-220SIS | DTMOSII |
| TK20D60U    |                          |           |                               |                 |                     | TO-220(W) |         |
| TK20J60U    |                          |           |                               |                 |                     | TO-3P(N)  |         |
| TK40J60T    |                          | 40        | 0.08                          | 67              | 3900                | TO-3P(N)  | DTMOSI  |
| TK50J60U *  | 50                       | 0.065     | 70                            | 4300            | TO-3P(N)            | DTMOSII   |         |
| TK13A65U    | 650                      | 13        | 0.38                          | 17              | 950                 | TO-220SIS | DTMOSII |

\*: Under development

### ■ Performance Comparisons Between the New DT MOS and Conventional MOSFET ( $\pi$ -MOSVI) Devices (600 V/20 A)

| Characteristic                 | Symbol        | Test Conditions  | Series      |       |         | Series       |             |          | Unit          |
|--------------------------------|---------------|--|-------------|-------|---------|--------------|-------------|----------|---------------|
|                                |               |  | DTMOSII     |       |         | $\pi$ -MOSVI |             |          |               |
|                                |               |  | Part Number | Min   | Typ.    | Max          | Part Number | Min      |               |
| Gate leakage current           | $\pm I_{GSS}$ | $V_{GS}$ condition*, $V_{DS} = 0\text{ V}$                       | —           | —     | $\pm 1$ | —            | —           | $\pm 10$ | $\mu\text{A}$ |
| Drain cut-off current          | $I_{DSS}$     | $V_{DS} = 600\text{ V}, V_{GS} = 0\text{ V}$                     | —           | —     | 100     | —            | —           | 100      | $\mu\text{A}$ |
| Drain-source breakdown voltage | $V_{(BR)DSS}$ | $I_D = 10\text{ mA}, V_{GS} = 0\text{ V}$                        | 600         | —     | —       | 600          | —           | —        | V             |
| Gate threshold voltage         | $V_{th}$      | $V_{DS} = 10\text{ V}, I_D = 1\text{ mA}$                        | 3.0         | —     | 5.0     | 2.0          | —           | 4.0      | V             |
| Drain-source ON-resistance     | $R_{DS(ON)}$  | $V_{GS} = 10\text{ V}, I_D = 10\text{ A}$                        | —           | 0.165 | 0.19    | —            | 0.22        | 0.32     | $\Omega$      |
| Total gate charge              | $Q_g$         | $V_{DD} = 400\text{ V}, V_{GS} = 10\text{ V}, I_D = 20\text{ A}$ | —           | 27    | —       | —            | 60          | —        | nC            |
| Diode forward voltage          | $V_{DSF}$     | $I_{DR} = 20\text{ A}, V_{GS} = 0\text{ V}$                      | —           | —     | -1.7    | —            | —           | -1.7     | V             |

\*: Test conditions: TK20J60U:  $V_{GS} = \pm 30\text{ V}$ , 2SK3911:  $V_{GS} = \pm 25\text{ V}$

### ■ Figure-of-Merit (FOM) Comparison

$R_{on} \times Q_g$ , the product of ON-resistance and total gate charge, is reduced by 62%, compared with the conventional MOSFETs with the same chip size.

\* $R_{on} \times Q_g$  is a figure-of-merit index for the switching speed of MOSFETs.

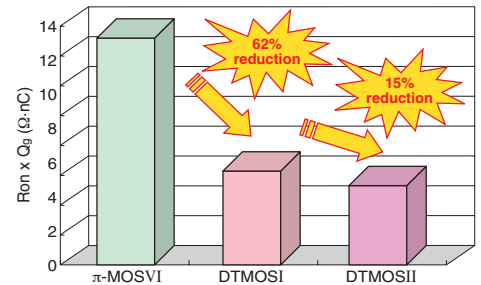

### ■ Performance Characteristics of the New DT MOS Series

#### TK20A60U Electrical Characteristics

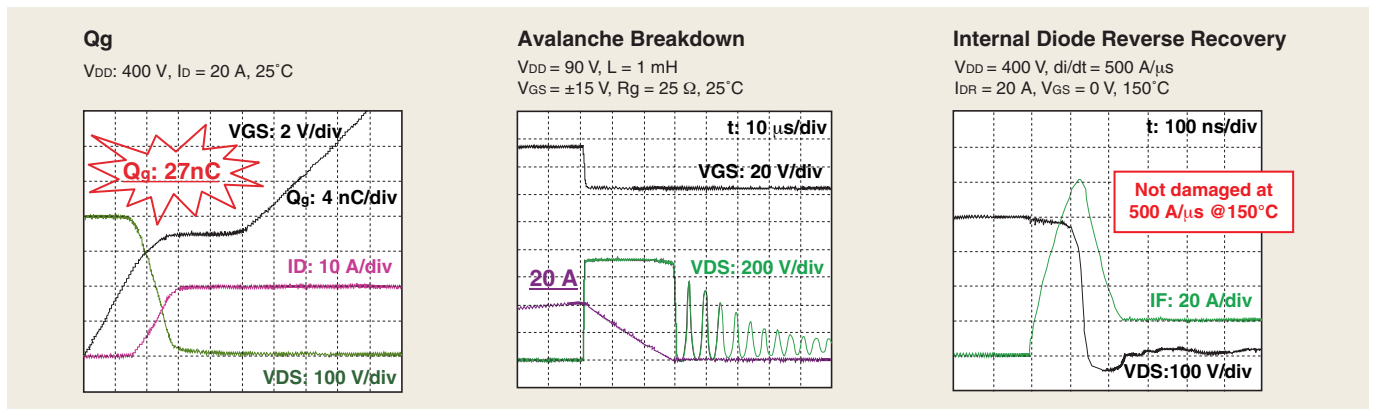

## 6-3 High-speed $\pi$ -MOS Series ( $V_{DSS} = 450\text{ V to }600\text{ V}$ )

To support the development of high-efficiency equipment, Toshiba has developed two series of high-speed power MOSFETs: a high-speed switching series for AC adapters and switching power supplies; and a high-speed diode series for motor controllers and inverter circuits.

- MACH Series: Achieves a higher switching speed than the existing  $\pi$ -MOS Series, which is currently well established in the market.
- High-Speed Diode Series: Achieves a higher internal diode speed by using lifetime control.

### ■ Product Offerings

- MACH Series

| Applications                            | Part Number | Absolute Maximum Ratings |           |           | Package     | $R_{DS(ON)}$ Max ( $\Omega$ ) | $V_{GS}$ (V) | $I_D$ (A) | $Q_g$ Typ. (nC) | Standard Type | Series  |
|---|-------------|--------------------------|-----------|-----------|-------------|-------------------------------|--------------|-----------|-----------------|---------------|---------|
|   |             | $V_{DSS}$ (V)            | $I_D$ (A) | $P_D$ (W) |             |                               |              |           |                 |               |         |
| AC adapters<br>Switching power supplies | 2SK3310     | 450                      | 10        | 40        | TO-220NIS   | 0.65                          | 10           | 5         | 23              | 2SK3126       | MACH-I  |
|   | 2SK3309     | 450                      | 10        | 65        | TO-220FL/SM | 0.65                          | 10           | 5         | 23              | —             |         |
|   | 2SK3743     | 450                      | 13        | 40        | TO-220NIS   | 0.4                           | 10           | 6         | 34              | —             |         |
|   | 2SK3403     | 450                      | 13        | 100       | TO-220FL/SM | 0.4                           | 10           | 6         | 34              | —             |         |
|   | 2SK3312     | 600                      | 6         | 65        | TO-220FL/SM | 1.25                          | 10           | 3         | 25              | 2SK2777       |         |
|   | 2SK3437     | 600                      | 10        | 80        | TO-220FL/SM | 1                             | 10           | 5         | 28              | 2SK2996       |         |
|   | 2SK3399     | 600                      | 10        | 100       | TO-220FL/SM | 0.75                          | 10           | 5         | 35              | 2SK2866       |         |
|   | 2SK3907     | 500                      | 23        | 150       | TO-3P(N)    | 0.23                          | 10           | 11.5      | 60              | —             | MACH-II |
| 2SK3911                                 | 600         | 20                       | 150       | TO-3P(N)  | 0.32        | 10                            | 10           | 60        | —               |               |         |

- High-Speed Diode Series (HSD Series)

| Applications   | Part Number | Absolute Maximum Ratings |           |           | Package     | $R_{DS(ON)}$ Max ( $\Omega$ ) | $V_{GS}$ (V) | $I_D$ (A) | trr Typ. (ns) | Standard Type |
|--|-------------|--------------------------|-----------|-----------|-------------|-------------------------------|--------------|-----------|---------------|---------------|
|  |             | $V_{DSS}$ (V)            | $I_D$ (A) | $P_D$ (W) |             |                               |              |           |               |               |
| Motor control<br>Inverters<br>Switching power supplies | 2SK3868     | 500                      | 5         | 35        | TO-220SIS   | 1.7                           | 10           | 2.5       | 150           | 2SK3563       |
|  | 2SK3417     | 500                      | 5         | 50        | TO-220FL/SM | 1.8                           | 10           | 2.5       | 60            | 2SK2991       |
|  | 2SK4042     | 500                      | 8         | 40        | TO-220SIS   | 0.97                          | 10           | 4         | 185           | 2SK3561       |
|  | 2SK3313     | 500                      | 12        | 40        | TO-220NIS   | 0.62                          | 10           | 6         | 90            | 2SK2842       |
|  | 2SK3314     | 500                      | 15        | 150       | TO-3P(N)    | 0.49                          | 10           | 7         | 105           | 2SK2698       |
|  | 2SK3131     | 500                      | 50        | 250       | TO-3P(L)    | 0.11                          | 10           | 25        | 105           | 2SK3132       |
|  | 2SK3936     | 500                      | 23        | 150       | TO-3P(N)    | 0.25                          | 10           | 11.5      | 380           | 2SK3907       |
|  | 2SK3947     | 600                      | 6         | 40        | TO-220SIS   | 1.4                           | 10           | 3         | 150           | 2SK3562       |
|  | 2SK4015     | 600                      | 10        | 45        | TO-220SIS   | 0.86                          | 10           | 5         | 170           | 2SK3569       |
|  | 2SK4016     | 600                      | 13        | 50        | TO-220SIS   | 0.50                          | 10           | 6.5       | 160           | 2SK3911       |
|  | 2SK3906     | 600                      | 20        | 150       | TO-3P(N)    | 0.33                          | 10           | 10        | 400           | 2SK3797       |

### ■ Characteristics of the MACHII Series

40% reduction in  $Q_g$  losses

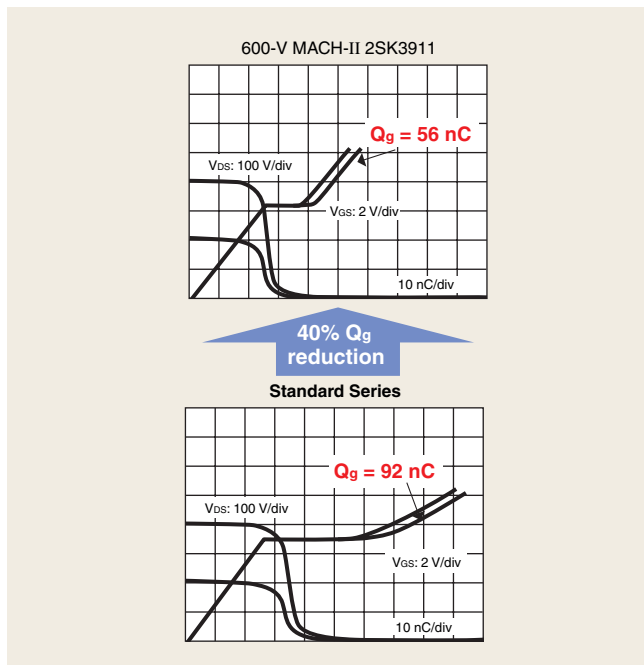

### ■ Characteristics of the High-Speed Diode Series

Faster internal diode

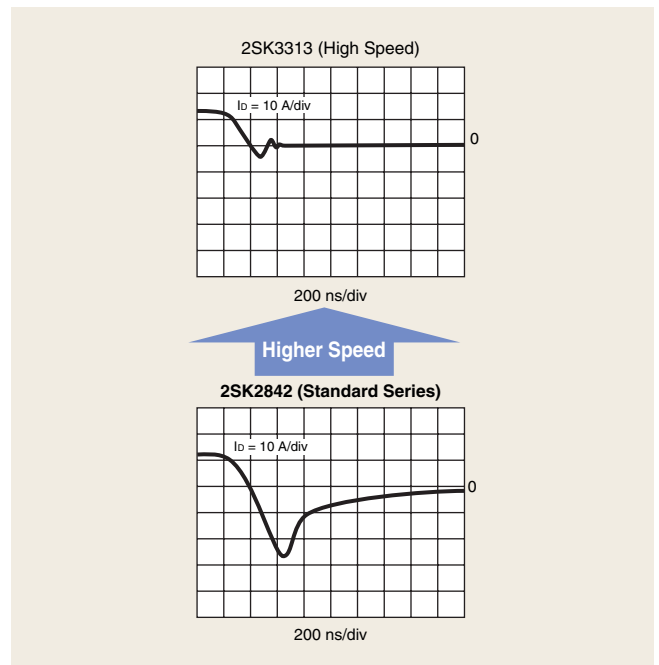

## 6-4 $\pi$ -MOS Series

### ■ $\pi$ -MOSVI Series ( $V_{DSS} = 450\text{ V to }600\text{ V}$ )

| Series       | Part Number | Absolute Maximum Ratings |           | $R_{DS(ON)}$ Max ( $\Omega$ ) |      | $Q_g$ Typ. (nC) | $C_{iss}$ Typ. (pF) | Equivalent Predecessor Part | Package |
|--------------|-------------|--------------------------|-----------|-------------------------------|------|-----------------|---------------------|-----------------------------|---------|
|              |             | $V_{DSS}$ (V)            | $I_D$ (A) | $V_{GS} = 10\text{ V}$        |      |                 |                     |                             |         |
| $\pi$ -MOSVI | 2SK3757     | 450                      | 2         | 2.45                          | 9    | 330             | 2SK3543             | TO-220SIS                   |         |
|              | 2SK3766     |                          | 2         | 2.45                          | 8    | 270             | 2SK3543             | TO-220SIS                   |         |
|              | 2SK3869     |                          | 10        | 0.68                          | 28   | 1050            | 2SK3407             | TO-220SIS                   |         |
|              | 2SK3935     |                          | 17        | 0.25                          | 62   | 3100            | —                   | TO-220SIS                   |         |
|              | 2SK3904     |                          | 19        | 0.26                          | 62   | 3100            | —                   | TO-3P(N)                    |         |
|              | 2SK3563     |                          | 5         | 1.5                           | 16   | 550             | 2SK2662             | TO-220SIS                   |         |
|              | 2SK3863     | 5                        | 1.5       | 16                            | 550  | —               | DP                  |                             |         |
|              | 2SK4103     | 5                        | 1.5       | 16                            | 550  | 2SK3863         | New Pw-Mold         |                             |         |
|              | 2SK3561     | 8                        | 0.85      | 28                            | 1050 | 2SK2543         | TO-220SIS           |                             |         |
|              | 2SK3568     | 12                       | 0.52      | 42                            | 1500 | 2SK2842         | TO-220SIS           |                             |         |
|              | 2SK4012     | 13                       | 0.4       | 50                            | 2400 | —               | TO-220SIS           |                             |         |
|              | 2SK3934     | 15                       | 0.3       | 62                            | 3100 | —               | TO-220SIS           |                             |         |
|              | 2SK4107     | 15                       | 0.4       | 48                            | 2450 | 2SK2698         | TO-3P(N)            |                             |         |
|              | 2SK3905     | 17                       | 0.31      | 62                            | 3100 | —               | TO-3P(N)            |                             |         |
|              | 2SK4108     | 20                       | 0.27      | 70                            | 3400 | 2SK2837         | TO-3P(N)            |                             |         |
|              | 2SK3767     | 2                        | 4.5       | 9                             | 320  | 2SK3067         | TO-220SIS           |                             |         |
|              | 2SK3567     | 3.5                      | 2.2       | 17                            | 550  | 2SK2750         | TO-220SIS           |                             |         |
|              | 2SK3562     | 6                        | 1.25      | 28                            | 1050 | 2SK2545         | TO-220SIS           |                             |         |
|              | 2SK3667     | 7.5                      | 1.0       | 33                            | 1300 | 2SK2996         | TO-220SIS           |                             |         |
|              | 2SK3569     | 10                       | 0.75      | 42                            | 1500 | 2SK2843         | TO-220SIS           |                             |         |
| 2SK3797      | 13          | 0.43                     | 62        | 3150                          | —    | TO-220SIS       |                     |                             |         |
| 2SK3903      | 14          | 0.44                     | 62        | 3100                          | —    | TO-3P(N)        |                     |                             |         |

### ■ $\pi$ -MOSIV Series ( $V_{DSS} = 800\text{ V to }900\text{ V}$ )

| Series       | Part Number | Absolute Maximum Ratings |           | $R_{DS(ON)}$ Max ( $\Omega$ ) |      | $Q_g$ Typ. (nC) | $C_{iss}$ Typ. (pF) | Equivalent Predecessor Part | Package |
|--------------|-------------|--------------------------|-----------|-------------------------------|------|-----------------|---------------------|-----------------------------|---------|
|              |             | $V_{DSS}$ (V)            | $I_D$ (A) | $V_{GS} = 10\text{ V}$        |      |                 |                     |                             |         |
| $\pi$ -MOSIV | 2SK3633     | 800                      | 7         | 1.7                           | 35   | 1500            | 2SK2746             | TO-3P(N)                    |         |
|              | 2SK3879     |                          | 6.5       | 1.7                           | 35   | 1500            | —                   | TO-220FL/SM                 |         |
|              | 2SK3880     |                          | 6.5       | 1.7                           | 35   | 1500            | —                   | TO-3P(N)IS                  |         |
|              | 2SK4013     |                          | 6         | 1.7                           | 45   | 1400            | —                   | TO-220SIS                   |         |
|              | 2SK3566     |                          | 2.5       | 6.4                           | 12   | 470             | 2SK2718             | TO-220SIS                   |         |
|              | 2SK3564     |                          | 3         | 4.3                           | 17   | 700             | 2SK2700             | TO-220SIS                   |         |
|              | 2SK3798     | 4                        | 3.5       | 26                            | 800  | —               | TO-220SIS           |                             |         |
|              | 2SK3565     | 5                        | 2.5       | 28                            | 1150 | 2SK2717         | TO-220SIS           |                             |         |
|              | 2SK3742     | 5                        | 2.5       | 25                            | 1150 | 2SK2717         | TO-220SIS           |                             |         |
|              | 2SK3700     | 5                        | 2.5       | 28                            | 1150 | 2SK2610         | TO-3P(N)            |                             |         |
|              | 2SK4014     | 6                        | 2.0       | 45                            | 1400 | —               | TO-220SIS           |                             |         |
|              | 2SK4115     | 7                        | 2.0       | 45                            | 1650 | 2SK2749         | TO-3P(N)            |                             |         |
|              | 2SK3799     | 8                        | 1.3       | 60                            | 2200 | —               | TO-220SIS           |                             |         |
|              | 2SK3473     | 9                        | 1.6       | 38                            | 1450 | —               | TO-3P(N)            |                             |         |
|              | 2SK3878     | 9                        | 1.3       | 60                            | 2200 | 2SK2611         | TO-3P(N)            |                             |         |
|              | 2SK4207     | 13                       | 0.95      | 45                            | 2790 | —               | TO-3P(N)            |                             |         |

### ■ $L^2$ - $\pi$ -MOSV and VI Series ( $V_{DSS} = 30\text{ V to }100\text{ V}$ )

| Part Number | $V_{DSS}$ (V) | $I_D$ (A) | $P_D$ (W) | Package     | $R_{DS(ON)}$ ( $\Omega$ ) |        |              |           | $R_{DS(ON)}$ ( $\Omega$ ) |       |              |           | $Q_g$ Typ. (nC) |
|-------------|---------------|-----------|-----------|-------------|---------------------------|--------|--------------|-----------|---------------------------|-------|--------------|-----------|-----------------|
|             |               |           |           |             | Typ.                      | Max    | $V_{GS}$ (V) | $I_D$ (A) | Typ.                      | Max   | $V_{GS}$ (V) | $I_D$ (A) |                 |
| 2SJ537      | -50           | -5        | 0.9       | LSTM        | 0.16                      | 0.19   | -10          | -2.5      | 0.27                      | 0.34  | -4           | -1.3      | 18              |
| 2SJ360      | -60           | -1        | 0.5       | PW-Mini     | 0.55                      | 0.73   | -10          | -0.5      | 0.86                      | 1.2   | -4           | -0.5      | 6.5             |
| 2SJ507      | -60           | -1        | 0.9       | LSTM        | 0.5                       | 0.7    | -10          | -0.5      | 0.72                      | 1.0   | -4           | -0.5      | 5.6             |
| 2SJ438      | -60           | -5        | 25        | TO-220NIS   | 0.16                      | 0.19   | -10          | -2.5      | 0.24                      | 0.28  | -4           | -2.5      | 22              |
| 2SJ378      | -60           | -5        | 1.2       | TPS         | 0.16                      | 0.19   | -10          | -2.5      | 0.24                      | 0.28  | -4           | -2.5      | 22              |
| 2SJ349      | -60           | -20       | 45        | TO-220NIS   | 0.033                     | 0.045  | -10          | -10       | 0.05                      | 0.09  | -4           | -10       | 90              |
| 2SJ401      | -60           | -20       | 100       | TO-220FL/SM | 0.033                     | 0.045  | -10          | -10       | 0.05                      | 0.09  | -4           | -10       | 90              |
| 2SJ334      | -60           | -30       | 45        | TO-220NIS   | 0.029                     | 0.038  | -10          | -15       | 0.046                     | 0.06  | -4           | -15       | 110             |
| 2SJ402      | -60           | -30       | 100       | TO-220FL/SM | 0.029                     | 0.038  | -10          | -15       | 0.046                     | 0.06  | -4           | -15       | 110             |
| 2SJ508      | -100          | -1        | 1.5       | PW-Mini     | 1.34                      | 1.9    | -10          | -0.5      | 1.68                      | 2.5   | -4           | -0.5      | 6.3             |
| 2SJ509      | -100          | -1        | 0.9       | LSTM        | 1.34                      | 1.9    | -10          | -0.5      | 1.68                      | 2.5   | -4           | -0.5      | 6.3             |
| 2SJ380      | -100          | -12       | 35        | TO-220NIS   | 0.15                      | 0.21   | -10          | -6        | 0.25                      | 0.32  | -4           | -6        | 48              |
| 2SJ412      | -100          | -16       | 60        | TO-220FL/SM | 0.15                      | 0.21   | -10          | -6        | 0.25                      | 0.32  | -4           | -6        | 48              |
| 2SJ619      | -100          | -16       | 75        | TFP         | 0.15                      | 0.21   | -10          | -6        | 0.25                      | 0.32  | -4           | -6        | 48              |
| 2SJ620      | -100          | -18       | 25        | TFP         | 0.063                     | 0.09   | -10          | -9        | 0.085                     | 0.12  | -4           | -9        | 140             |
| 2SJ464      | -100          | -18       | 45        | TO-220NIS   | 0.064                     | 0.09   | -10          | -9        | 0.085                     | 0.12  | -4           | -9        | 140             |
| 2SK3506     | 30            | 45        | 100       | TO-3P(N)    | 0.016                     | 0.02   | 10           | 25        | —                         | —     | —            | —         | 39              |
| 2SK2989     | 50            | 5         | 0.9       | LSTM        | 0.12                      | 0.15   | 10           | 2.5       | 0.24                      | 0.33  | 4            | 1.3       | 6.5             |
| 2SK2614     | 50            | 20        | 40        | DP          | 0.032                     | 0.046  | 10           | 10        | 0.055                     | 0.08  | 4            | 5         | 25              |
| 2SK2507     | 50            | 25        | 30        | TO-220NIS   | 0.034                     | 0.046  | 10           | 12        | 0.058                     | 0.08  | 4            | 6         | 25              |
| 2SK2886     | 50            | 45        | 40        | TO-220NIS   | 0.014                     | 0.02   | 10           | 25        | 0.027                     | 0.036 | 4            | 25        | 66              |
| 2SK3051     | 50            | 45        | 40        | TO-220FL/SM | 0.024                     | 0.03   | 10           | 25        | —                         | —     | —            | —         | 36              |
| 2SK2744     | 50            | 45        | 125       | TO-3P(N)    | 0.015                     | 0.02   | 10           | 25        | —                         | —     | —            | —         | 68              |
| 2SK2550     | 50            | 45        | 100       | TO-3P(N)    | 0.024                     | 0.030  | 10           | 25        | —                         | —     | —            | —         | 36              |
| 2SK2551     | 50            | 50        | 150       | TO-3P(N)    | 0.0072                    | 0.011  | 10           | 25        | —                         | —     | —            | —         | 130             |
| 2SK2745     | 50            | 50        | 150       | TO-3P(N)    | 0.007                     | 0.0095 | 10           | 25        | 0.011                     | 0.016 | 4            | 25        | 130             |

| Part Number | $V_{DS}$ (V) | $I_D$ (A) | $P_D$ (W) | Package      | $R_{DS(ON)}$ ( $\Omega$ ) |       |              |           | $R_{DS(ON)}$ ( $\Omega$ ) |       |              |           | Qg Typ. (nC) |
|-------------|--------------|-----------|-----------|--------------|---------------------------|-------|--------------|-----------|---------------------------|-------|--------------|-----------|--------------|
|             |              |           |           |              | Typ.                      | Max   | $V_{GS}$ (V) | $I_D$ (A) | Typ.                      | Max   | $V_{GS}$ (V) | $I_D$ (A) |              |
| 2SK2615     | 60           | 2         | 0.5       | PW-Mini      | 0.23                      | 0.3   | 10           | 1         | 0.33                      | 0.44  | 4            | 1         | 6            |
| 2SK2961     | 60           | 2         | 0.9       | LSTM         | 0.2                       | 0.27  | 10           | 1         | 0.26                      | 0.38  | 4            | 1         | 5.8          |
| 2SK2229     | 60           | 5         | 1.2       | TPS          | 0.12                      | 0.16  | 10           | 2.5       | 0.2                       | 0.3   | 4            | 1.3       | 12           |
| 2SK2782     | 60           | 20        | 40        | DP           | 0.039                     | 0.055 | 10           | 10        | 0.06                      | 0.090 | 4            | 5         | 25           |
| 2SK2232     | 60           | 25        | 35        | TO-220NIS    | 0.036                     | 0.046 | 10           | 12        | 0.057                     | 0.08  | 4            | 12        | 38           |
| 2SK2311     | 60           | 25        | 40        | TO-220FL/SM  | 0.036                     | 0.046 | 10           | 12        | 0.057                     | 0.08  | 4            | 12        | 38           |
| 2SK2385     | 60           | 36        | 40        | TO-220NIS    | 0.022                     | 0.03  | 10           | 18        | 0.04                      | 0.055 | 4            | 15        | 60           |
| 2SK2233     | 60           | 45        | 100       | TO-3P(N)     | 0.022                     | 0.03  | 10           | 25        | 0.04                      | 0.055 | 4            | 15        | 60           |
| 2SK2266     | 60           | 45        | 65        | TO-220FL/SM  | 0.022                     | 0.03  | 10           | 25        | 0.04                      | 0.055 | 4            | 15        | 60           |
| 2SK2376     | 60           | 45        | 100       | TO-220FL/SM  | 0.013                     | 0.017 | 10           | 25        | 0.019                     | 0.025 | 4            | 25        | 110          |
| 2SK2398     | 60           | 45        | 100       | TO-3P(N)     | 0.022                     | 0.03  | 10           | 25        | —                         | —     | —            | —         | 60           |
| 2SK2173     | 60           | 50        | 125       | TO-3P(N)     | 0.013                     | 0.017 | 10           | 25        | 0.019                     | 0.025 | 4            | 25        | 110          |
| 2SK2445     | 60           | 50        | 125       | TO-3P(N)     | 0.014                     | 0.018 | 10           | 25        | —                         | —     | —            | —         | 110          |
| 2SK2267     | 60           | 60        | 150       | TO-3P(L)     | 0.008                     | 0.011 | 10           | 30        | 0.012                     | 0.015 | 4            | 30        | 170          |
| 2SK2313     | 60           | 60        | 150       | TO-3P(N)     | 0.008                     | 0.011 | 10           | 30        | 0.012                     | 0.015 | 4            | 30        | 170          |
| 2SK2962     | 100          | 1         | 0.9       | LSTM         | 0.5                       | 0.7   | 10           | 0.5       | 0.65                      | 0.95  | 4            | 0.5       | 6.3          |
| 2SK2963     | 100          | 1         | 0.5       | PW-Mini      | 0.5                       | 0.7   | 10           | 0.5       | 0.65                      | 0.95  | 4            | 0.5       | 6.3          |
| 2SK2200     | 100          | 3         | 1.3       | TPS          | 0.28                      | 0.35  | 10           | 2         | 0.36                      | 0.45  | 4            | 2         | 13.5         |
| 2SK2201     | 100          | 3         | 20        | New PW-Mold  | 0.28                      | 0.35  | 10           | 2         | 0.36                      | 0.45  | 4            | 2         | 13.5         |
| 2SK4018     | 100          | 3         | 20        | New PW-Mold2 | 0.28                      | 0.35  | 10           | 2         | 0.35                      | 0.45  | 4            | 2         | 13.5         |
| 2SK2399     | 100          | 5         | 20        | New PW-Mold  | 0.17                      | 0.23  | 10           | 2.5       | 0.22                      | 0.3   | 4            | 2.5       | 22           |
| 2SK2400     | 100          | 5         | 1.2       | TPS          | 0.17                      | 0.23  | 10           | 2.5       | 0.22                      | 0.3   | 4            | 2.5       | 22           |
| 2SK4019     | 100          | 5         | 20        | New PW-Mold2 | 0.17                      | 0.23  | 10           | 2.5       | 0.22                      | 0.3   | 4            | 2.5       | 22           |
| 2SK2391     | 100          | 20        | 35        | TO-220NIS    | 0.068                     | 0.085 | 10           | 10        | 0.09                      | 0.13  | 4            | 10        | 50           |
| 2SK2314     | 100          | 27        | 75        | TO-220AB     | 0.066                     | 0.085 | 10           | 15        | 0.09                      | 0.13  | 4            | 15        | 50           |
| 2SK2789     | 100          | 27        | 60        | TO-220FL/SM  | 0.066                     | 0.085 | 10           | 15        | 0.09                      | 0.13  | 4            | 15        | 50           |
| 2SK3387     | 150          | 18        | 100       | TFP          | 0.08                      | 0.12  | 10           | 9         | 0.09                      | 0.18  | 4            | 9         | 57           |

■  $\pi$ -MOSV Series ( $V_{DS} = 150$  V to 250 V)

| Applications                                      | Part Number | Absolute Maximum Ratings |           |             | Package      | $R_{DS(ON)}$ ( $\Omega$ ) |       |              |           | Qg Typ. (nC) |
|---|-------------|--------------------------|-----------|-------------|--------------|---------------------------|-------|--------------|-----------|--------------|
|   |             | $V_{DS}$ (V)             | $I_D$ (A) | $P_D$ (W)   |              | Typ.                      |       | $V_{GS}$ (V) | $I_D$ (A) |              |
|   |             |                          |           |             |              | Max                       | Max   |              |           |              |
| DC-DC converters<br>Monitors<br>Motor controllers | 2SJ618      | -180                     | -10       | 130         | TO-3P(N)     | —                         | 0.37  | -10          | -5        | 18           |
|   | 2SJ407      | -200                     | -5        | 30          | TO-220NIS    | 0.8                       | 1.0   | -10          | -2.5      | 20           |
|   | 2SJ567      | -200                     | -2.5      | 20          | New PW-Mold  | 1.6                       | 2.0   | -10          | -1.5      | 10           |
|   | 2SJ676      | -200                     | -2.5      | 1.3         | TPS          | 1.6                       | 2.0   | -10          | -1.5      | 10           |
|   | 2SJ680      | -200                     | -2.5      | 20          | New PW-Mold2 | 1.6                       | 2.0   | -10          | -1.5      | 10           |
|   | 2SJ610      | -250                     | -2        | 20          | PW-Mold      | 1.85                      | 2.55  | -10          | -1.0      | 24           |
|   | 2SJ512      | -250                     | -5        | 30          | TO-220NIS    | 1.0                       | 1.25  | -10          | -2.5      | 22           |
|   | 2SJ516      | -250                     | -6.5      | 35          | TO-220NIS    | 0.6                       | 0.8   | -10          | -3        | 29           |
|   | 2SK3670     | 150                      | 0.67      | 0.9         | LSTM         | 1.0                       | 1.7   | 4            | 0.5       | 4.6          |
|   | 2SK3205     | 150                      | 5         | 20          | PW-Mold      | 0.36                      | 0.5   | 10           | 2.5       | 12           |
|   | 2SK2882     | 150                      | 18        | 45          | TO-220NIS    | 0.08                      | 0.12  | 10           | 9         | 57           |
|   | 2SK3497     | 180                      | 10        | 130         | TO-3P(N)     | —                         | 0.15  | 10           | 5         | —            |
|   | 2SK2992     | 200                      | 1         | 1.5         | PW-Mini      | 2.2                       | 3.5   | 10           | 0.5       | 3            |
|   | 2SK2835     | 200                      | 5         | 1.3         | TPS          | 0.56                      | 0.8   | 10           | 2.5       | 10           |
|   | 2SK2381     | 200                      | 5         | 25          | TO-220NIS    | 0.56                      | 0.8   | 10           | 2.5       | 10           |
|   | 2SK2920     | 200                      | 5         | 20          | New PW-Mold  | 0.56                      | 0.8   | 10           | 2.5       | 10           |
|   | 2SK4020     | 200                      | 5         | 20          | New PW-Mold2 | 0.52                      | 0.8   | 10           | 2.5       | 10           |
|   | 2SK2350     | 200                      | 8.5       | 30          | TO-220NIS    | 0.26                      | 0.4   | 10           | 5         | 17           |
|   | 2SK2965     | 200                      | 11        | 35          | TO-220NIS    | 0.15                      | 0.26  | 10           | 5.5       | 30           |
|   | 2SK2382     | 200                      | 15        | 45          | TO-220NIS    | 0.13                      | 0.18  | 10           | 10        | 40           |
|   | 2SK2401     | 200                      | 15        | 75          | TO-220FL/SM  | 0.13                      | 0.18  | 10           | 10        | 40           |
|   | 2SK3625     | 200                      | 25        | 100         | TO-220FL/SM  | 0.065                     | 0.082 | 10           | 12.5      | 44           |
|   | 2SK3444     | 200                      | 25        | 125         | TFP          | 0.067                     | 0.082 | 10           | 12.5      | 44           |
|   | 2SK3176     | 250                      | 30        | 150         | TO-3P(N)     | 0.038                     | 0.052 | 10           | 15        | 125          |
|   | 2SK3462     | 250                      | 3         | 20          | New PW-Mold  | 1.2                       | 1.7   | 10           | 1.5       | 12           |
|   | 2SK4022     | 250                      | 3         | 20          | New PW-Mold2 | 1.2                       | 1.7   | 10           | 1.5       | 12           |
|   | 2SK3342     | 250                      | 4.5       | 20          | New PW-Mold  | 0.8                       | 1.0   | 10           | 2.5       | 10           |
|   | 2SK4021     | 250                      | 4.5       | 20          | New PW-Mold2 | 0.8                       | 1.0   | 10           | 2.5       | 10           |
|   | 2SK2417     | 250                      | 7.5       | 30          | TO-220NIS    | 0.42                      | 0.5   | 10           | 3.5       | 20           |
|   | 2SK2914     | 250                      | 7.5       | 20          | TO-220AB     | 0.42                      | 0.5   | 10           | 3.5       | 20           |
|   | 2SK2508     | 250                      | 13        | 45          | TO-220NIS    | 0.18                      | 0.25  | 10           | 6.5       | 40           |
|   | 2SK2598     | 250                      | 13        | 60          | TO-220FL/SM  | 0.18                      | 0.25  | 10           | 6.5       | 40           |
| 2SK2993   | 250         | 20                       | 100       | TO-220FL/SM | 0.082        | 0.105                     | 10    | 10           | 100       |              |
| 2SK3994   | 250         | 20                       | 45        | TO-220NIS   | 0.090        | 0.105                     | 10    | 10           | 45        |              |
| 2SK3388   | 250         | 20                       | 125       | TFP         | 0.082        | 0.105                     | 10    | 10           | 100       |              |
| 2SK3445   | 250         | 20                       | 125       | TFP         | 0.09         | 0.105                     | 10    | 10           | 45        |              |
| 2SK2967   | 250         | 30                       | 150       | TO-3P(N)    | 0.048        | 0.068                     | 10    | 15           | 132       |              |
| 2SK2995   | 250         | 30                       | 90        | TO-3P(N)IS  | 0.048        | 0.068                     | 10    | 15           | 132       |              |

■ π-MOSV Series (V<sub>DSS</sub> = 400 V to 700 V)

| Applications  | Part Number | Absolute Maximum Ratings |                       |                       | Package      | R <sub>DS(ON)</sub>        |       |                        |                       | Qg<br>Typ.<br>(nC) |
|---|-------------|--------------------------|-----------------------|-----------------------|--------------|----------------------------|-------|------------------------|-----------------------|--------------------|
|   |             | V <sub>DSS</sub><br>(V)  | I <sub>D</sub><br>(A) | P <sub>D</sub><br>(W) |              | R <sub>DS(ON)</sub><br>(Ω) |       | V <sub>GS</sub><br>(V) | I <sub>D</sub><br>(A) |                    |
|   |             |                          |                       |                       |              | Typ.                       | Max   |                        |                       |                    |
| 115-Vac<br>switching power supplies<br>Ballast inverters<br>Motor controllers | 2SK3498     | 400                      | 1                     | 20                    | PW-Mold      | 4.2                        | 5.5   | 10                     | 0.5                   | 5.7                |
|   | 2SK2838     | 400                      | 5.5                   | 40                    | TO-220FL/SM  | 0.84                       | 1.2   | 10                     | 3                     | 17                 |
|   | 2SK2679     | 400                      | 5.5                   | 35                    | TO-220NIS    | 0.84                       | 1.2   | 10                     | 3                     | 17                 |
|   | 2SK2952     | 400                      | 8.5                   | 40                    | TO-220NIS    | 0.4                        | 0.55  | 10                     | 5                     | 34                 |
|   | 2SK2841     | 400                      | 10                    | 80                    | TO-220AB     | 0.4                        | 0.55  | 10                     | 5                     | 34                 |
|   | 2SK2949     | 400                      | 10                    | 80                    | TO-220FL/SM  | 0.4                        | 0.55  | 10                     | 5                     | 34                 |
|   | 2SK3499     | 400                      | 10                    | 80                    | TFP          | 0.4                        | 0.55  | 10                     | 5                     | 34                 |
|   | 2SK3472     | 450                      | 1                     | 20                    | New PW-Mold  | 4.0                        | 4.6   | 10                     | 0.5                   | 5                  |
|   | 2SK3374     | 450                      | 1                     | 20                    | TPS          | 3.7                        | 4.6   | 10                     | 5                     | 5                  |
|   | 2SK4023     | 450                      | 1                     | 20                    | New PW-Mold2 | 4.0                        | 4.6   | 10                     | 0.5                   | 5                  |
|   | 2SK3544     | 450                      | 13                    | 100                   | TFP          | 0.29                       | 0.4   | 10                     | 6                     | 34                 |
|   | 2SK2998     | 500                      | 0.5                   | 0.9                   | LSTM         | 10                         | 18    | 10                     | 0.25                  | 3.8                |
|   | 2SK3302     | 500                      | 0.5                   | 1.3                   | TPS          | 10                         | 18    | 10                     | 0.25                  | 3.8                |
|   | 2SK3471     | 500                      | 0.5                   | 0.5                   | PW-Mini      | 10                         | 18    | 10                     | 0.25                  | 3.8                |
|   | 2SK2599     | 500                      | 2                     | 1.3                   | TPS          | 2.9                        | 3.2   | 10                     | 1                     | 9                  |
|   | 2SK3373     | 500                      | 2                     | 20                    | New PW-Mold  | 2.9                        | 3.2   | 10                     | 1                     | 9                  |
|   | 2SK2862     | 500                      | 3                     | 25                    | TO-220NIS    | 2.9                        | 3.2   | 10                     | 1                     | 9                  |
|   | 2SK2991     | 500                      | 5                     | 50                    | TO-220FL/SM  | 1.35                       | 1.5   | 10                     | 2.5                   | 17                 |
|   | 2SK3466     | 500                      | 5                     | 50                    | TO-220FL/SM  | 1.35                       | 1.5   | 10                     | 2.5                   | 17                 |
|   | 2SK2542     | 500                      | 8                     | 80                    | TO-220AB     | 0.75                       | 0.85  | 10                     | 4                     | 30                 |
|   | 2SK2776     | 500                      | 8                     | 65                    | TO-220FL/SM  | 0.75                       | 0.85  | 10                     | 4                     | 30                 |
|   | 2SK3538     | 500                      | 8                     | 65                    | TFP          | 0.75                       | 0.85  | 10                     | 4                     | 30                 |
|   | 2SK2601     | 500                      | 10                    | 125                   | TO-3P(N)     | 0.56                       | 1.0   | 10                     | 5                     | 30                 |
|   | 2SK3068     | 500                      | 12                    | 100                   | TO-220FL/SM  | 0.4                        | 0.52  | 10                     | 6                     | 45                 |
|   | 2SK3398     | 500                      | 12                    | 100                   | TFP          | 0.4                        | 0.52  | 10                     | 6                     | 45                 |
|   | 2SK2916     | 500                      | 14                    | 80                    | TO-3P(N)IS   | 0.35                       | 0.4   | 10                     | 7                     | 58                 |
|   | 2SK2917     | 500                      | 18                    | 90                    | TO-3P(N)IS   | 0.21                       | 0.27  | 10                     | 10                    | 80                 |
|   | 2SK3132     | 500                      | 50                    | 250                   | TO-3P(L)     | 0.07                       | 0.095 | 10                     | 25                    | 280                |
|   | 2SK3371     | 600                      | 1                     | 20                    | New PW-Mold  | 6.4                        | 9.0   | 10                     | 0.5                   | 9                  |
|   | 2SK4026     | 600                      | 1                     | 20                    | New PW-Mold2 | 6.4                        | 9     | 10                     | 0.5                   | 9                  |
|   | 2SK2846     | 600                      | 2                     | 1.3                   | TPS          | 4.2                        | 5.0   | 10                     | 1                     | 9                  |
|   | 2SK2865     | 600                      | 2                     | 20                    | New PW-Mold  | 4.2                        | 5.0   | 10                     | 1                     | 9                  |
|   | 2SK4002     | 600                      | 2                     | 20                    | New PW-Mold2 | 4.2                        | 5     | 10                     | 1                     | 9                  |
|   | 2SK4003     | 600                      | 3                     | 20                    | New PW-Mold2 | 1.7                        | 2.2   | 10                     | 1.5                   | 20                 |
|   | 2SK3975     | 600                      | 3                     | 20                    | New PW-Mold  | 1.7                        | 2.2   | 10                     | 1.5                   | 20                 |
|   | 2SK3085     | 600                      | 3.5                   | 75                    | TO-220AB     | 1.7                        | 2.2   | 10                     | 1.8                   | 20                 |
|   | 2SK3130     | 600                      | 6                     | 40                    | TO-220NIS    | 1.26                       | 1.55  | 10                     | 3                     | 30                 |
|   | 2SK2777     | 600                      | 6                     | 65                    | TO-220FL/SM  | 0.9                        | 1.25  | 10                     | 3                     | 30                 |
|   | 2SK2602     | 600                      | 6                     | 125                   | TO-3P(N)     | 0.9                        | 1.25  | 10                     | 3                     | 30                 |
|   | 2SK3312     | 600                      | 6                     | 65                    | TO-220FL/SM  | 0.95                       | 1.25  | 10                     | 3                     | 22                 |
|   | 2SK3438     | 600                      | 10                    | 80                    | TFP          | 0.78                       | 1.0   | 10                     | 5                     | 28                 |
|   | 2SK2889     | 600                      | 10                    | 100                   | TO-220FL/SM  | 0.54                       | 0.75  | 10                     | 5                     | 45                 |
|   | 2SK2866     | 600                      | 10                    | 125                   | TO-220AB     | 0.54                       | 0.75  | 10                     | 5                     | 45                 |
|   | 2SK2699     | 600                      | 10                    | 150                   | TO-3P(N)     | 0.5                        | 0.65  | 10                     | 6                     | 58                 |
|   | 2SK2953     | 600                      | 12                    | 90                    | TO-3P(N)IS   | 0.31                       | 0.4   | 10                     | 8                     | 80                 |
| 2SK3265   | 700         | 10                       | 45                    | TO-220NIS             | 0.72         | 1.0                        | 10    | 5                      | 53                    |                    |
| 2SK3453   | 700         | 10                       | 80                    | TO-3P(N)IS            | 0.72         | 1.0                        | 10    | 5                      | 53                    |                    |

■ π-MOSIII Series (V<sub>BSS</sub> = 800 V to 1000 V)

| Applications | Absolute Maximum Ratings |                    |                    | Package     | R <sub>DS(ON)</sub> (Ω) |      |                     |                    | Qg<br>Typ.<br>(nC) |
|--------------|--------------------------|--------------------|--------------------|-------------|-------------------------|------|---------------------|--------------------|--------------------|
|              | V <sub>BSS</sub> (V)     | I <sub>D</sub> (A) | P <sub>D</sub> (W) |             | Typ.                    | Max  | V <sub>GS</sub> (V) | I <sub>D</sub> (A) |                    |
| 2SK2603      | 800                      | 3                  | 100                | TO-220AB    | 3.0                     | 3.6  | 10                  | 1.5                | 25                 |
| 2SK2883      | 800                      | 3                  | 75                 | TO-220FL/SM | 3.0                     | 3.6  | 10                  | 1.5                | 25                 |
| 2SK2884      | 800                      | 5                  | 100                | TO-220FL/SM | 1.9                     | 2.2  | 10                  | 3.0                | 34                 |
| 2SK2746      | 800                      | 7                  | 150                | TO-3P(N)    | 1.3                     | 1.7  | 10                  | 3.5                | 55                 |
| 2SK2606      | 800                      | 8                  | 85                 | TO-3P(N)IS  | 1.0                     | 1.2  | 10                  | 4.0                | 68                 |
| 2SK2607      | 800                      | 9                  | 150                | TO-3P(N)    | 1.0                     | 1.2  | 10                  | 4.0                | 68                 |
| 2SK3301      | 900                      | 1                  | 20                 | PW-Mold     | 15                      | 20   | 10                  | 0.5                | 6                  |
| 2SK2845      | 900                      | 1                  | 40                 | DP          | 8.0                     | 9.0  | 10                  | 0.5                | 15                 |
| 2SK2733      | 900                      | 1                  | 60                 | TO-220AB    | 8.0                     | 9.0  | 10                  | 0.5                | 15                 |
| 2SK2608      | 900                      | 3                  | 100                | TO-220AB    | 3.73                    | 4.3  | 10                  | 1.5                | 25                 |
| 2SK2719      | 900                      | 3                  | 125                | TO-3P(N)    | 3.7                     | 4.3  | 10                  | 1.5                | 25                 |
| 2SK2847      | 900                      | 8                  | 85                 | TO-3P(N)IS  | 1.05                    | 1.25 | 10                  | 4.0                | 58                 |
| 2SK3017      | 900                      | 8.5                | 90                 | TO-3P(N)IS  | 1.2                     | 1.4  | 10                  | 4.0                | 70                 |
| 2SK2968      | 900                      | 10                 | 150                | TO-3P(N)    | 1.05                    | 1.25 | 10                  | 4                  | 70                 |
| 2SK2613      | 1000                     | 8                  | 150                | TO-3P(N)    | 1.4                     | 1.7  | 10                  | 8.0                | 65                 |

## 7-1 Alphanumeric Index of Part Numbers

| Part Number | Series                         | Package      | Main Characteristics    |                       |  | Page |
|-------------|--------------------------------|--------------|-------------------------|-----------------------|--|------|
|             |                                |              | V <sub>DSS</sub><br>(V) | I <sub>D</sub><br>(A) | R <sub>DS(ON)</sub><br>Max<br>( $\Omega$ ) |      |
| 2SJ168      | $\pi$ -MOSIII                  | S-MINI       | -60                     | -0.2                  | 2  | 36   |
| 2SJ200      | $\pi$ -MOSII                   | TO-3P (N)    | -180                    | -10                   | 0.83                                       | -    |
| 2SJ201      | $\pi$ -MOSII                   | TO-3P (L)    | -200                    | -12                   | 0.63                                       | -    |
| 2SJ304      | L <sup>2</sup> - $\pi$ -MOSIV  | TO-220NIS    | -60                     | -14                   | 0.12                                       | -    |
| 2SJ305      | $\pi$ -MOSIII                  | S-MINI       | -30                     | -0.2                  | 4  | 36   |
| 2SJ312      | L <sup>2</sup> - $\pi$ -MOSIV  | TO-220FL/SM  | -60                     | -14                   | 0.12                                       | -    |
| 2SJ313      | $\pi$ -MOSII                   | TO-220NIS    | -180                    | -1                    | 5  | -    |
| 2SJ334      | L <sup>2</sup> - $\pi$ -MOSV   | TO-220NIS    | -60                     | -30                   | 0.038                                      | 43   |
| 2SJ338      | $\pi$ -MOSII                   | PW-Mold      | -180                    | -1                    | 5  | -    |
| 2SJ343      | $\pi$ -MOSIII                  | S-MINI       | -50                     | -0.05                 | 50   | 36   |
| 2SJ344      | $\pi$ -MOSIII                  | USM          | -50                     | -0.05                 | 50   | 36   |
| 2SJ349      | L <sup>2</sup> - $\pi$ -MOSV   | TO-220NIS    | -60                     | -20                   | 0.045                                      | 43   |
| 2SJ360      | L <sup>2</sup> - $\pi$ -MOSV   | PW-Mini      | -60                     | -1                    | 0.73                                       | 43   |
| 2SJ378      | L <sup>2</sup> - $\pi$ -MOSV   | TPS          | -60                     | -5                    | 0.19                                       | 43   |
| 2SJ380      | L <sup>2</sup> - $\pi$ -MOSV   | TO-220NIS    | -100                    | -12                   | 0.21                                       | 43   |
| 2SJ401      | L <sup>2</sup> - $\pi$ -MOSV   | TO-220FL/SM  | -60                     | -20                   | 0.045                                      | 43   |
| 2SJ402      | L <sup>2</sup> - $\pi$ -MOSV   | TO-220FL/SM  | -60                     | -30                   | 0.038                                      | 43   |
| 2SJ407      | $\pi$ -MOSV                    | TO-220NIS    | -200                    | -5                    | 1  | 44   |
| 2SJ412      | L <sup>2</sup> - $\pi$ -MOSV   | TO-220FL/SM  | -100                    | -16                   | 0.21                                       | 43   |
| 2SJ438      | L <sup>2</sup> - $\pi$ -MOSV   | TO-220NIS    | -60                     | -5                    | 0.19                                       | 43   |
| 2SJ440      | $\pi$ -MOSII                   | TO-3P (N)IS  | -180                    | -9                    | 0.8  | -    |
| 2SJ464      | L <sup>2</sup> - $\pi$ -MOSV   | TO-220NIS    | -100                    | -18                   | 0.09                                       | 43   |
| 2SJ507      | L <sup>2</sup> - $\pi$ -MOSV   | LSTM         | -60                     | -1                    | 0.7  | 43   |
| 2SJ508      | L <sup>2</sup> - $\pi$ -MOSV   | PW-Mini      | -100                    | -1                    | 1.9  | 43   |
| 2SJ509      | L <sup>2</sup> - $\pi$ -MOSV   | LSTM         | -100                    | -1                    | 1.9  | 43   |
| 2SJ512      | $\pi$ -MOSV                    | TO-220NIS    | -250                    | -5                    | 1.25                                       | 44   |
| 2SJ516      | $\pi$ -MOSV                    | TO-220NIS    | -250                    | -6.5                  | 0.8  | 44   |
| 2SJ537      | L <sup>2</sup> - $\pi$ -MOSV   | LSTM         | -50                     | -5                    | 0.19                                       | 43   |
| 2SJ567      | $\pi$ -MOSV                    | New PW-Mold  | -200                    | -2.5                  | 2  | 44   |
| 2SJ610      | $\pi$ -MOSV                    | PW-Mold      | -250                    | -2                    | 2.55                                       | 44   |
| 2SJ618      | $\pi$ -MOSV                    | TO-3P (N)    | -180                    | -10                   | 0.37                                       | 44   |
| 2SJ619      | L <sup>2</sup> - $\pi$ -MOSV   | TFP          | -100                    | -16                   | 0.21                                       | 43   |
| 2SJ620      | L <sup>2</sup> - $\pi$ -MOSV   | TFP          | -100                    | -18                   | 0.09                                       | 43   |
| 2SJ668      | U-MOSIII                       | New PW-Mold  | -60                     | -5                    | 0.17                                       | 38   |
| 2SJ669      | U-MOSIII                       | TPS          | -60                     | -5                    | 0.17                                       | 38   |
| 2SJ676      | $\pi$ -MOSV                    | TPS          | -200                    | -2.5                  | 2  | 44   |
| 2SJ680      | $\pi$ -MOSV                    | New PW-Mold2 | -200                    | -2.5                  | 2  | 44   |
| 2SJ681      | U-MOSIII                       | New PW-Mold2 | -60                     | -5                    | 0.17                                       | 38   |
| 2SK1062     | $\pi$ -MOSIII                  | S-MINI       | 60                      | 0.2                   | 1  | 36   |
| 2SK1119     | $\pi$ -MOSII.5                 | TO-220AB     | 1000                    | 4                     | 3.8  | -    |
| 2SK1359     | $\pi$ -MOSII.5                 | TO-3P (N)    | 100                     | 5                     | 3.8  | -    |
| 2SK1365     | $\pi$ -MOSII.5                 | TO-3P (N)IS  | 1000                    | 7                     | 1.8  | -    |
| 2SK1381     | L <sup>2</sup> - $\pi$ -MOSIII | TO-3P (N)    | 100                     | 50                    | 0.032                                      | -    |
| 2SK1382     | L <sup>2</sup> - $\pi$ -MOSIII | TO-3P (L)    | 100                     | 60                    | 0.02                                       | -    |
| 2SK1486     | $\pi$ -MOSIII.5                | TO-3P (L)    | 300                     | 32                    | 0.095                                      | -    |
| 2SK1489     | $\pi$ -MOSIII.5                | TO-3P (L)    | 1000                    | 12                    | 1  | -    |
| 2SK1529     | $\pi$ -MOSII                   | TO-3P (N)    | 180                     | 10                    | 0.83                                       | -    |
| 2SK1530     | $\pi$ -MOSII                   | TO-3P (N)    | 200                     | 12                    | 0.63                                       | -    |
| 2SK1544     | $\pi$ -MOSIII.5                | TO-3P (L)    | 500                     | 25                    | 0.2  | -    |
| 2SK1930     | $\pi$ -MOSII.5                 | TO-220FL/SM  | 1000                    | 4                     | 3.8  | -    |
| 2SK2009     | $\pi$ -MOSIII                  | S-MINI       | 30                      | 0.2                   | 2  | 36   |
| 2SK2013     | $\pi$ -MOSII                   | TO-220NIS    | 180                     | 1                     | 5  | -    |

| Part Number | Series                       | Package     | Main Characteristics    |                       |  | Page |
|-------------|------------------------------|-------------|-------------------------|-----------------------|--|------|
|             |                              |             | V <sub>DSS</sub><br>(V) | I <sub>D</sub><br>(A) | R <sub>DS(ON)</sub><br>Max<br>( $\Omega$ ) |      |
| 2SK2162     | $\pi$ -MOSII                 | PW-Mold     | 180                     | 1                     | 5  | -    |
| 2SK2173     | L <sup>2</sup> - $\pi$ -MOSV | TO-3P (N)   | 60                      | 50                    | 0.017                                      | 44   |
| 2SK2200     | L <sup>2</sup> - $\pi$ -MOSV | TPS         | 100                     | 3                     | 0.35                                       | 44   |
| 2SK2201     | L <sup>2</sup> - $\pi$ -MOSV | New PW-Mold | 100                     | 3                     | 0.35                                       | 44   |
| 2SK2229     | L <sup>2</sup> - $\pi$ -MOSV | TPS         | 60                      | 5                     | 0.16                                       | 44   |
| 2SK2232     | L <sup>2</sup> - $\pi$ -MOSV | TO-220NIS   | 60                      | 25                    | 0.046                                      | 44   |
| 2SK2233     | L <sup>2</sup> - $\pi$ -MOSV | TO-3P (N)   | 60                      | 45                    | 0.03                                       | 44   |
| 2SK2266     | L <sup>2</sup> - $\pi$ -MOSV | TO-220FL/SM | 60                      | 45                    | 0.03                                       | 44   |
| 2SK2267     | L <sup>2</sup> - $\pi$ -MOSV | TO-3P (L)   | 60                      | 60                    | 0.011                                      | 44   |
| 2SK2274     | $\pi$ -MOSII.5               | TO-220NIS   | 700                     | 5                     | 1.7  | -    |
| 2SK2311     | L <sup>2</sup> - $\pi$ -MOSV | TO-220FL/SM | 60                      | 25                    | 0.046                                      | 44   |
| 2SK2313     | L <sup>2</sup> - $\pi$ -MOSV | TO-3P (N)   | 60                      | 60                    | 0.011                                      | 44   |
| 2SK2314     | L <sup>2</sup> - $\pi$ -MOSV | TO-220AB    | 100                     | 27                    | 0.085                                      | 44   |
| 2SK2350     | $\pi$ -MOSV                  | TO-220NIS   | 200                     | 8.5                   | 0.4  | 44   |
| 2SK2376     | L <sup>2</sup> - $\pi$ -MOSV | TO-220FL/SM | 60                      | 45                    | 0.017                                      | 44   |
| 2SK2381     | $\pi$ -MOSV                  | TO-220NIS   | 200                     | 5                     | 0.8  | 44   |
| 2SK2382     | $\pi$ -MOSV                  | TO-220NIS   | 200                     | 15                    | 0.18                                       | 44   |
| 2SK2385     | L <sup>2</sup> - $\pi$ -MOSV | TO-220NIS   | 60                      | 36                    | 0.03                                       | 44   |
| 2SK2391     | L <sup>2</sup> - $\pi$ -MOSV | TO-220NIS   | 100                     | 20                    | 0.085                                      | 44   |
| 2SK2398     | L <sup>2</sup> - $\pi$ -MOSV | TO-3P (N)   | 60                      | 45                    | 0.03                                       | 44   |
| 2SK2399     | L <sup>2</sup> - $\pi$ -MOSV | New PW-Mold | 100                     | 5                     | 0.23                                       | 44   |
| 2SK2400     | L <sup>2</sup> - $\pi$ -MOSV | TPS         | 100                     | 5                     | 0.23                                       | 44   |
| 2SK2401     | $\pi$ -MOSV                  | TO-220FL/SM | 200                     | 15                    | 0.18                                       | 44   |
| 2SK2417     | $\pi$ -MOSV                  | TO-220NIS   | 250                     | 7.5                   | 0.5  | 44   |
| 2SK2445     | L <sup>2</sup> - $\pi$ -MOSV | TO-3P (N)   | 60                      | 50                    | 0.018                                      | 44   |
| 2SK2467     | $\pi$ -MOSII                 | TO-3P (N)IS | 180                     | 9                     | 0.8  | -    |
| 2SK2507     | L <sup>2</sup> - $\pi$ -MOSV | TO-220NIS   | 50                      | 25                    | 0.046                                      | 43   |
| 2SK2508     | $\pi$ -MOSV                  | TO-220NIS   | 250                     | 13                    | 0.25                                       | 44   |
| 2SK2542     | $\pi$ -MOSV                  | TO-220AB    | 500                     | 8                     | 0.85                                       | 45   |
| 2SK2550     | L <sup>2</sup> - $\pi$ -MOSV | TO-3P (N)   | 50                      | 45                    | 0.03                                       | 43   |
| 2SK2551     | L <sup>2</sup> - $\pi$ -MOSV | TO-3P (N)   | 50                      | 50                    | 0.011                                      | 43   |
| 2SK2598     | $\pi$ -MOSV                  | TO-220FL/SM | 250                     | 13                    | 0.25                                       | 44   |
| 2SK2599     | $\pi$ -MOSV                  | TPS         | 500                     | 2                     | 3.2  | 45   |
| 2SK2601     | $\pi$ -MOSV                  | TO-3P (N)   | 500                     | 10                    | 1  | 45   |
| 2SK2602     | $\pi$ -MOSV                  | TO-3P (N)   | 600                     | 6                     | 1.25                                       | 45   |
| 2SK2603     | $\pi$ -MOSIII                | TO-220AB    | 800                     | 3                     | 3.6  | 45   |
| 2SK2606     | $\pi$ -MOSIII                | TO-3P (N)IS | 800                     | 8                     | 1.2  | 45   |
| 2SK2607     | $\pi$ -MOSIII                | TO-3P (N)   | 800                     | 9                     | 1.2  | 45   |
| 2SK2608     | $\pi$ -MOSIII                | TO-220AB    | 900                     | 3                     | 4.3  | 45   |
| 2SK2613     | $\pi$ -MOSIII                | TO-3P (N)   | 1000                    | 8                     | 1.7  | 45   |
| 2SK2614     | L <sup>2</sup> - $\pi$ -MOSV | DP          | 50                      | 20                    | 0.046                                      | 43   |
| 2SK2615     | L <sup>2</sup> - $\pi$ -MOSV | PW-Mini     | 60                      | 2                     | 0.3  | 44   |
| 2SK2679     | $\pi$ -MOSV                  | TO-220NIS   | 400                     | 5.5                   | 1.2  | 45   |
| 2SK2699     | $\pi$ -MOSV                  | TO-3P (N)   | 600                     | 12                    | 0.65                                       | 45   |
| 2SK2719     | $\pi$ -MOSIII                | TO-3P (N)   | 900                     | 3                     | 4.3  | 45   |
| 2SK2733     | $\pi$ -MOSIII                | TO-220AB    | 900                     | 1                     | 9  | 45   |
| 2SK2744     | L <sup>2</sup> - $\pi$ -MOSV | TO-3P (N)   | 50                      | 45                    | 0.02                                       | 43   |
| 2SK2745     | L <sup>2</sup> - $\pi$ -MOSV | TO-3P (N)   | 50                      | 50                    | 0.0095                                     | 43   |
| 2SK2776     | $\pi$ -MOSV                  | TO-220FL/SM | 500                     | 8                     | 0.85                                       | 45   |
| 2SK2777     | $\pi$ -MOSV                  | TO-220FL/SM | 600                     | 6                     | 1.25                                       | 45   |
| 2SK2782     | L <sup>2</sup> - $\pi$ -MOSV | DP          | 60                      | 20                    | 0.055                                      | 44   |
| 2SK2789     | L <sup>2</sup> - $\pi$ -MOSV | TO-220FL/SM | 100                     | 27                    | 0.085                                      | 44   |

| Part Number | Series                       | Package     | Main Characteristics    |                       |  | Page  |
|-------------|------------------------------|-------------|-------------------------|-----------------------|--|-------|
|             |                              |             | V <sub>BSS</sub><br>(V) | I <sub>D</sub><br>(A) | R <sub>DS(ON)</sub><br>Max<br>( $\Omega$ ) |       |
| 2SK2835     | $\pi$ -MOSV                  | TPS         | 200                     | 5                     | 0.8  | 44    |
| 2SK2838     | $\pi$ -MOSV                  | TO-220FL/SM | 400                     | 5.5                   | 1.2  | 45    |
| 2SK2841     | $\pi$ -MOSV                  | TO-220AB    | 400                     | 10                    | 0.55                                       | 45    |
| 2SK2845     | $\pi$ -MOSIII                | DP          | 900                     | 1                     | 9  | 45    |
| 2SK2846     | $\pi$ -MOSV                  | TPS         | 600                     | 2                     | 5  | 45    |
| 2SK2847     | $\pi$ -MOSIII                | TO-3P (N)IS | 900                     | 8                     | 1.4  | 45    |
| 2SK2862     | $\pi$ -MOSV                  | TO-220NIS   | 500                     | 3                     | 3.2  | 45    |
| 2SK2865     | $\pi$ -MOSV                  | New PW-Mold | 600                     | 2                     | 5  | 45    |
| 2SK2866     | $\pi$ -MOSV                  | TO-220AB    | 600                     | 10                    | 0.75                                       | 42,45 |
| 2SK2882     | $\pi$ -MOSV                  | TO-220NIS   | 150                     | 18                    | 0.12                                       | 44    |
| 2SK2883     | $\pi$ -MOSIII                | TO-220FL/SM | 800                     | 3                     | 3.6  | 45    |
| 2SK2884     | $\pi$ -MOSIII                | TO-220FL/SM | 800                     | 5                     | 2.2  | 45    |
| 2SK2886     | L <sup>2</sup> - $\pi$ -MOSV | TO-220NIS   | 50                      | 45                    | 0.02                                       | 43    |
| 2SK2889     | $\pi$ -MOSV                  | TO-220FL/SM | 600                     | 10                    | 0.75                                       | 45    |
| 2SK2914     | $\pi$ -MOSV                  | TO-220AB    | 250                     | 7.5                   | 0.5  | 44    |
| 2SK2916     | $\pi$ -MOSV                  | TO-3P (N)IS | 500                     | 14                    | 0.4  | 45    |
| 2SK2917     | $\pi$ -MOSV                  | TO-3P (N)IS | 500                     | 18                    | 0.27                                       | 45    |
| 2SK2920     | $\pi$ -MOSV                  | New PW-Mold | 200                     | 5                     | 0.8  | 44    |
| 2SK2949     | $\pi$ -MOSV                  | TO-220FL/SM | 400                     | 10                    | 0.55                                       | 45    |
| 2SK2952     | $\pi$ -MOSV                  | TO-220NIS   | 400                     | 8.5                   | 0.55                                       | 45    |
| 2SK2953     | $\pi$ -MOSV                  | TO-3P (N)IS | 600                     | 15                    | 0.4  | 45    |
| 2SK2961     | L <sup>2</sup> - $\pi$ -MOSV | LSTM        | 60                      | 2                     | 0.27                                       | 44    |
| 2SK2962     | L <sup>2</sup> - $\pi$ -MOSV | LSTM        | 100                     | 1                     | 0.7  | 44    |
| 2SK2963     | L <sup>2</sup> - $\pi$ -MOSV | PW-Mini     | 100                     | 1                     | 0.7  | 44    |
| 2SK2965     | $\pi$ -MOSV                  | TO-220NIS   | 200                     | 11                    | 0.26                                       | 44    |
| 2SK2967     | $\pi$ -MOSV                  | TO-3P (N)   | 250                     | 30                    | 0.068                                      | 44    |
| 2SK2968     | $\pi$ -MOSIII                | TO-3P (N)   | 900                     | 10                    | 1.25                                       | 45    |
| 2SK2989     | L <sup>2</sup> - $\pi$ -MOSV | LSTM        | 50                      | 5                     | 0.15                                       | 43    |
| 2SK2991     | $\pi$ -MOSV                  | TO-220FL/SM | 500                     | 5                     | 1.5  | 42,45 |
| 2SK2992     | $\pi$ -MOSV                  | PW-Mini     | 200                     | 1                     | 3.5  | 44    |
| 2SK2993     | $\pi$ -MOSV                  | TO-220FL/SM | 250                     | 20                    | 0.105                                      | 44    |
| 2SK2995     | $\pi$ -MOSV                  | TO-3P (N)IS | 250                     | 30                    | 0.068                                      | 44    |
| 2SK2998     | $\pi$ -MOSV                  | LSTM        | 500                     | 0.5                   | 18   | 45    |
| 2SK3017     | $\pi$ -MOSIII                | TO-3P (N)IS | 900                     | 8.5                   | 1.25                                       | 45    |
| 2SK3051     | L <sup>2</sup> - $\pi$ -MOSV | TO-220FL/SM | 50                      | 45                    | 0.03                                       | 43    |
| 2SK3068     | $\pi$ -MOSV                  | TO-220FL/SM | 500                     | 12                    | 0.52                                       | 45    |
| 2SK3085     | $\pi$ -MOSV                  | TO-220AB    | 600                     | 3.5                   | 2.2  | 45    |
| 2SK3130     | $\pi$ -MOSV                  | TO-220NIS   | 600                     | 6                     | 1.55                                       | 45    |
| 2SK3131     | $\pi$ -MOSV(HSD)             | TO-3P (L)   | 500                     | 50                    | 0.11                                       | 42    |
| 2SK3132     | $\pi$ -MOSV                  | TO-3P (L)   | 500                     | 50                    | 0.095                                      | 42,45 |
| 2SK3176     | $\pi$ -MOSV                  | TO-3P (N)   | 200                     | 30                    | 0.052                                      | 44    |
| 2SK3205     | $\pi$ -MOSV                  | PW-Mold     | 150                     | 5                     | 0.5  | 44    |
| 2SK3265     | $\pi$ -MOSV                  | TO-220NIS   | 700                     | 10                    | 1  | 45    |
| 2SK3301     | $\pi$ -MOSIII                | PW-Mold     | 900                     | 1                     | 20   | 45    |
| 2SK3302     | $\pi$ -MOSV                  | TPS         | 500                     | 0.5                   | 18   | 45    |
| 2SK3309     | MACH                         | TO-220FL/SM | 450                     | 10                    | 0.65                                       | 42    |
| 2SK3310     | MACH                         | TO-220NIS   | 450                     | 10                    | 0.65                                       | 42    |
| 2SK3312     | $\pi$ -MOSV                  | TO-220FL/SM | 600                     | 6                     | 1.25                                       | 42,45 |
| 2SK3313     | $\pi$ -MOSV(HSD)             | TO-220NIS   | 500                     | 12                    | 0.62                                       | 42    |
| 2SK3314     | $\pi$ -MOSV(HSD)             | TO-3P (N)   | 500                     | 15                    | 0.49                                       | 42    |
| 2SK3342     | $\pi$ -MOSV                  | New PW-Mold | 250                     | 4.5                   | 1  | 44    |
| 2SK3371     | $\pi$ -MOSV                  | New PW-Mold | 600                     | 1                     | 9  | 45    |
| 2SK3373     | $\pi$ -MOSV                  | New PW-Mold | 500                     | 2                     | 3.2  | 45    |
| 2SK3374     | $\pi$ -MOSV                  | TPS         | 450                     | 1                     | 4.6  | 45    |
| 2SK3387     | L <sup>2</sup> - $\pi$ -MOSV | TFP         | 150                     | 18                    | 0.12                                       | 44    |

| Part Number | Series             | Package     | Main Characteristics    |                       |  | Page     |
|-------------|--------------------|-------------|-------------------------|-----------------------|--|----------|
|             |                    |             | V <sub>BSS</sub><br>(V) | I <sub>D</sub><br>(A) | R <sub>DS(ON)</sub><br>Max<br>( $\Omega$ ) |          |
| 2SK3388     | $\pi$ -MOSV        | TFP         | 250                     | 20                    | 0.105                                      | 44       |
| 2SK3398     | $\pi$ -MOSV        | TFP         | 500                     | 12                    | 0.52                                       | 45       |
| 2SK3399     | MACH               | TO-220FL/SM | 600                     | 10                    | 0.75                                       | 42       |
| 2SK3403     | MACH               | TO-220FL/SM | 450                     | 13                    | 0.4  | 42       |
| 2SK3417     | $\pi$ -MOSV(HSD)   | TO-220FL/SM | 500                     | 5                     | 1.8  | 42       |
| 2SK3437     | MACH               | TO-220FL/SM | 600                     | 10                    | 1  | 42       |
| 2SK3438     | $\pi$ -MOSV        | TFP         | 600                     | 10                    | 1  | 45       |
| 2SK3444     | $\pi$ -MOSV        | TFP         | 200                     | 25                    | 0.082                                      | 44       |
| 2SK3445     | $\pi$ -MOSV        | TFP         | 250                     | 20                    | 0.105                                      | 44       |
| 2SK3453     | $\pi$ -MOSIV       | TO-3P (N)IS | 700                     | 10                    | 1  | 45       |
| 2SK3462     | $\pi$ -MOSV        | New PW-Mold | 250                     | 3                     | 1.7  | 44       |
| 2SK3466     | $\pi$ -MOSV        | TFP         | 500                     | 5                     | 1.5  | 45       |
| 2SK3471     | $\pi$ -MOSV        | PW-Mini     | 500                     | 0.5                   | 18   | 45       |
| 2SK3472     | $\pi$ -MOSV        | PW-Mold     | 450                     | 1                     | 4.6  | 45       |
| 2SK3473     | $\pi$ -MOSIV       | TO-3P (N)   | 900                     | 9                     | 1.6  | 43       |
| 2SK3497     | $\pi$ -MOSV        | TO-3P (N)   | 180                     | 10                    | 0.15                                       | 44       |
| 2SK3498     | $\pi$ -MOSV        | PW-Mold     | 400                     | 1                     | 5.5  | 45       |
| 2SK3499     | $\pi$ -MOSV        | TFP         | 400                     | 10                    | 0.55                                       | 45       |
| 2SK3506     | $\pi$ -MOSVI       | TO-3P (N)   | 30                      | 45                    | 0.02                                       | 43       |
| 2SK3538     | $\pi$ -MOSV        | TFP         | 500                     | 8                     | 0.85                                       | 45       |
| 2SK3544     | $\pi$ -MOSV        | TFP         | 450                     | 13                    | 0.4  | 45       |
| 2SK3561     | $\pi$ -MOSVI       | TO-220SIS   | 500                     | 8                     | 0.85                                       | 40,42,43 |
| 2SK3562     | $\pi$ -MOSVI       | TO-220SIS   | 600                     | 6                     | 1.25                                       | 40,42,43 |
| 2SK3563     | $\pi$ -MOSVI       | TO-220SIS   | 500                     | 5                     | 1.5  | 40,42,43 |
| 2SK3564     | $\pi$ -MOSIV       | TO-220SIS   | 900                     | 3                     | 4.3  | 43       |
| 2SK3565     | $\pi$ -MOSIV       | TO-220SIS   | 900                     | 5                     | 2.5  | 43       |
| 2SK3566     | $\pi$ -MOSIV       | TO-220SIS   | 900                     | 2.5                   | 6.4  | 43       |
| 2SK3567     | $\pi$ -MOSVI       | TO-220SIS   | 600                     | 3.5                   | 2.2  | 40,43    |
| 2SK3568     | $\pi$ -MOSVI       | TO-220SIS   | 500                     | 12                    | 0.52                                       | 40,43    |
| 2SK3569     | $\pi$ -MOSVI       | TO-220SIS   | 600                     | 10                    | 0.75                                       | 40,42,43 |
| 2SK3625     | $\pi$ -MOSV        | TO-220FL/SM | 200                     | 25                    | 0.082                                      | 44       |
| 2SK3633     | $\pi$ -MOSIV       | TO-3P (N)   | 800                     | 7                     | 1.7  | 43       |
| 2SK3662     | U-MOSIII           | TO-220NIS   | 60                      | 35                    | 0.0125                                     | 38       |
| 2SK3667     | $\pi$ -MOSVI       | TO-220SIS   | 600                     | 7.5                   | 1  | 40,43    |
| 2SK3669     | $\pi$ -MOSVII      | New PW-Mold | 100                     | 10                    | 0.125                                      | -        |
| 2SK3670     | $\pi$ -MOSV        | LSTM        | 150                     | 0.67                  | 1.7  | 44       |
| 2SK3700     | $\pi$ -MOSIV       | TO-3P (N)   | 900                     | 5                     | 2.5  | 43       |
| 2SK3742     | $\pi$ -MOSIV       | TO-220SIS   | 900                     | 5                     | 2.5  | 43       |
| 2SK3743     | MACH               | TO-220NIS   | 450                     | 13                    | 0.6  | 40,42    |
| 2SK3754     | U-MOSIII           | TO-220NIS   | 30                      | 5                     | 0.089                                      | 38       |
| 2SK3757     | $\pi$ -MOSVI       | TO-220SIS   | 450                     | 2                     | 2.45                                       | 43       |
| 2SK3766     | $\pi$ -MOSVI       | TO-220SIS   | 450                     | 2                     | 2.45                                       | 43       |
| 2SK3767     | $\pi$ -MOSVI       | TO-220SIS   | 600                     | 2                     | 4.5  | 43       |
| 2SK3797     | $\pi$ -MOSVI       | TO-220SIS   | 600                     | 13                    | 0.43                                       | 40,42,43 |
| 2SK3798     | $\pi$ -MOSIV       | TO-220SIS   | 900                     | 4                     | 3.5  | 43       |
| 2SK3799     | $\pi$ -MOSIV       | TO-220SIS   | 900                     | 8                     | 1.3  | 43       |
| 2SK3842     | U-MOSIII           | TFP         | 60                      | 75                    | 0.0058                                     | 38       |
| 2SK3843     | U-MOSIII           | TFP         | 40                      | 75                    | 0.0035                                     | 38       |
| 2SK3844     | U-MOSIII           | TO-220NIS   | 60                      | 45                    | 0.0058                                     | 38       |
| 2SK3845     | U-MOSIII           | TO-3P (N)   | 60                      | 70                    | 0.0058                                     | 38       |
| 2SK3846     | U-MOSIII           | TO-220NIS   | 40                      | 26                    | 0.018                                      | 38       |
| 2SK3847     | U-MOSIII           | TO-220SM    | 40                      | 32                    | 0.016                                      | 38       |
| 2SK3863     | $\pi$ -MOSVI       | DP          | 500                     | 5                     | 1.5  | 43       |
| 2SK3868     | $\pi$ -MOSVI (HSD) | TO-220SIS   | 500                     | 5                     | 1.7  | 42       |
| 2SK3869     | $\pi$ -MOSVI       | TO-220SIS   | 450                     | 10                    | 0.68                                       | 43       |

| Part Number | Series                 | Package      | Main Characteristics    |                       |                                   | Page  |
|-------------|------------------------|--------------|-------------------------|-----------------------|-----------------------------------|-------|
|             |                        |              | V <sub>bss</sub><br>(V) | I <sub>b</sub><br>(A) | R <sub>DS(ON)</sub><br>Max<br>(Ω) |       |
| 2SK3878     | π-MOSIV                | TO-3P (N)    | 900                     | 9                     | 1.3                               | 43    |
| 2SK3879     | π-MOSIV                | TO-220FL/SM  | 800                     | 6.5                   | 1.7                               | 43    |
| 2SK3880     | π-MOSIV                | TO-3P (N)IS  | 800                     | 6.5                   | 1.7                               | 43    |
| 2SK3903     | π-MOSVI                | TO-3P (N)    | 600                     | 14                    | 0.44                              | 43    |
| 2SK3904     | π-MOSVI                | TO-3P (N)    | 450                     | 19                    | 0.26                              | 43    |
| 2SK3905     | π-MOSVI                | TO-3P (N)    | 500                     | 17                    | 0.31                              | 43    |
| 2SK3906     | MACH (HSD)             | TO-3P (N)    | 600                     | 20                    | 0.33                              | 42    |
| 2SK3907     | MACH                   | TO-3P (N)    | 500                     | 23                    | 0.23                              | 42    |
| 2SK3911     | MACH                   | TO-3P (N)    | 600                     | 20                    | 0.32                              | 41,42 |
| 2SK3934     | π-MOSVI                | TO-220SIS    | 500                     | 15                    | 0.3                               | 40,43 |
| 2SK3935     | π-MOSVI                | TO-220SIS    | 450                     | 17                    | 0.25                              | 43    |
| 2SK3936     | MACH (HSD)             | TO-3P (N)    | 500                     | 23                    | 0.25                              | 42    |
| 2SK3947     | π-MOSVI (HSD)          | TO-220SIS    | 600                     | 6                     | 1.4                               | 42    |
| 2SK3975     | π-MOSV                 | New PW-Mold  | 600                     | 3                     | 2.2                               | 45    |
| 2SK3994     | π-MOSV                 | TO-220NIS    | 250                     | 20                    | 0.105                             | 44    |
| 2SK4002     | π-MOSV                 | New PW-Mold2 | 600                     | 2                     | 5                                 | 40,45 |
| 2SK4003     | π-MOSV                 | New PW-Mold2 | 600                     | 3                     | 2.2                               | 45    |
| 2SK4012     | π-MOSVI                | TO-220SIS    | 500                     | 13                    | 0.4                               | 40,43 |
| 2SK4013     | π-MOSIV                | TO-220SIS    | 800                     | 6                     | 1.7                               | 43    |
| 2SK4014     | π-MOSIV                | TO-220SIS    | 900                     | 6                     | 2                                 | 43    |
| 2SK4015     | π-MOSVI (HSD)          | TO-220SIS    | 600                     | 10                    | 0.86                              | 42    |
| 2SK4016     | π-MOSVI (HSD)          | TO-220SIS    | 600                     | 13                    | 0.5                               | 42    |
| 2SK4017     | U-MOSIII               | New PW-Mold2 | 60                      | 5                     | 0.1                               | 38    |
| 2SK4018     | L <sup>2</sup> -π-MOSV | New PW-Mold2 | 100                     | 3                     | 0.35                              | 44    |
| 2SK4019     | L <sup>2</sup> -π-MOSV | New PW-Mold2 | 100                     | 5                     | 0.23                              | 44    |
| 2SK4020     | π-MOSV                 | New PW-Mold2 | 200                     | 5                     | 0.8                               | 44    |
| 2SK4021     | π-MOSV                 | New PW-Mold2 | 250                     | 4.5                   | 1                                 | 44    |
| 2SK4022     | π-MOSV                 | New PW-Mold2 | 250                     | 3                     | 1.7                               | 44    |
| 2SK4023     | π-MOSV                 | New PW-Mold2 | 450                     | 1                     | 4.6                               | 45    |
| 2SK4026     | π-MOSV                 | New PW-Mold2 | 600                     | 1                     | 9                                 | 45    |
| 2SK4033     | U-MOSIII               | New PW-Mold  | 60                      | 5                     | 0.1                               | 38    |
| 2SK4034     | U-MOSIII               | TFP          | 60                      | 75                    | 0.0058                            | 38    |
| 2SK4042     | π-MOSVI (HSD)          | TO-220SIS    | 500                     | 8                     | 0.97                              | 42    |
| 2SK4103     | π-MOSVI                | New PW-Mold  | 500                     | 5                     | 1.5                               | 43    |
| 2SK4107     | π-MOSVI                | TO-3P (N)    | 500                     | 15                    | 0.4                               | 40,43 |
| 2SK4108     | π-MOSVI                | TO-3P (N)    | 500                     | 20                    | 0.27                              | 40,43 |
| 2SK4115     | π-MOSIV                | TO-3P (N)    | 900                     | 7                     | 2                                 | 43    |
| 2SK4207     | π-MOSIV                | TO-3P (N)    | 900                     | 13                    | 0.95                              | 43    |
| S3U72       | U-MOSV-H               | SOP Advance  | 30                      | TBD                   | TBD                               | 35    |
| S3W16       | U-MOSIV-H              | SOP Advance  | 30                      | (40)                  | (0.0035)                          | -     |
| SSM3J01T    | π-MOSVI                | TSM          | -30                     | -1.7                  | 0.4                               | 28    |
| SSM3J02T    | π-MOSVI                | TSM          | -30                     | -1.5                  | 0.5                               | 28    |
| SSM3J05FU   | π-MOSVI                | USM          | -20                     | -0.2                  | 4                                 | 36    |
| SSM3J09FU   | π-MOSVI                | USM          | -30                     | -0.2                  | 4.2                               | 36    |
| SSM3J108TU  | U-MOSIII               | UFM          | -20                     | -1.8                  | 0.158                             | 28    |
| SSM3J109TU  | U-MOSII                | UFM          | -20                     | -2                    | 0.13                              | 28    |
| SSM3J110TU  | U-MOSIII               | UFM          | -12                     | -2.3                  | 0.094                             | 28    |
| SSM3J111TU  | U-MOSIII               | UFM          | -20                     | -1                    | 0.48                              | 28    |
| SSM3J112TU  | U-MOSII                | UFM          | -30                     | -1.1                  | 0.79                              | 28    |
| SSM3J113TU  | U-MOSIII               | UFM          | -20                     | -1.7                  | 0.169                             | 28    |
| SSM3J114TU  | U-MOSIV                | UFM          | -20                     | -1.8                  | 0.149                             | 28    |
| SSM3J115TU  | U-MOSIV                | UFM          | -20                     | -2.2                  | 0.098                             | 28    |
| SSM3J117TU  | U-MOSII                | UFM          | -30                     | -2                    | 0.225                             | 28    |
| SSM3J118TU  | U-MOSII                | UFM          | -30                     | -1.4                  | 0.48                              | 28    |
| SSM3J120TU  | U-MOSIV                | UFM          | -20                     | -4                    | 0.038                             | 28    |

| Part Number | Series     | Package | Main Characteristics    |                       |                                   | Page |
|-------------|------------|---------|-------------------------|-----------------------|-----------------------------------|------|
|             |            |         | V <sub>bss</sub><br>(V) | I <sub>b</sub><br>(A) | R <sub>DS(ON)</sub><br>Max<br>(Ω) |      |
| SSM3J129TU  | U-MOSV     | UFM     | -20                     | -4.6                  | 0.046                             | 28   |
| SSM3J130TU  | U-MOSVI    | UFM     | -20                     | -4.4                  | 0.0258                            | 28   |
| SSM3J132TU  | U-MOSVI    | UFM     | -12                     | -5                    | 0.0178                            | 28   |
| SSM3J13T    | U-MOSIII   | TSM     | -12                     | -3                    | 0.07                              | 28   |
| SSM3J14T    | U-MOSII    | TSM     | -30                     | -2.7                  | 0.17                              | 28   |
| SSM3J15CT   | π-MOSVI    | CST3    | -30                     | -0.1                  | 32                                | 36   |
| SSM3J15F    | π-MOSVI    | S-MINI  | -30                     | -0.1                  | 32                                | 36   |
| SSM3J15FS   | π-MOSVI    | SSM     | -30                     | -0.1                  | 32                                | 36   |
| SSM3J15FU   | π-MOSVI    | USM     | -30                     | -0.1                  | 32                                | 36   |
| SSM3J15FV   | π-MOSVI    | VESM    | -30                     | -0.1                  | 32                                | 36   |
| SSM3J16CT   | π-MOSVI    | CST3    | -20                     | -0.1                  | 45                                | 36   |
| SSM3J16FS   | π-MOSVI    | SSM     | -20                     | -0.1                  | 45                                | 36   |
| SSM3J16FU   | π-MOSVI    | USM     | -20                     | -0.1                  | 45                                | 36   |
| SSM3J16FV   | π-MOSVI    | VESM    | -20                     | -0.1                  | 45                                | 48   |
| SSM3J304T   | U-MOSIII   | TSM     | -20                     | -2.3                  | 0.127                             | 28   |
| SSM3J305T   | U-MOSII    | TSM     | -30                     | -1.7                  | 0.477                             | 28   |
| SSM3J306T   | U-MOSII    | TSM     | -30                     | -2.4                  | 0.225                             | 28   |
| SSM3J307T   | U-MOSV     | TSM     | -20                     | -5.0                  | 0.031                             | 28   |
| SSM3J312T   | U-MOSIII   | TSM     | -12                     | -2.7                  | 0.091                             | 28   |
| SSM3J313T   | U-MOSIII   | TSM     | -20                     | -1.6                  | 0.268                             | 28   |
| SSM3J314T   | U-MOSIII-H | TSM     | -30                     | -3.5                  | 0.1                               | 28   |
| SSM3J317T   | U-MOSIII   | TSM     | -20                     | -3.6                  | 0.107                             | 28   |
| SSM3J321T   | U-MOSV     | TSM     | -20                     | -5.2                  | 0.046                             | 28   |
| SSM3J325F   | U-MOSVI    | S-MINI  | -20                     | -2.0                  | 0.155                             | 28   |
| SSM3J326T   | U-MOSVI    | TSM     | -30                     | -5.6                  | 0.0457                            | 28   |
| SSM3J327F   | U-MOSVI    | S-MINI  | -20                     | -3.5                  | 0.095                             | 28   |
| SSM3J35CT   | π-MOSVI    | CST3    | -20                     | -0.1                  | 44                                | 36   |
| SSM3J35FS   | π-MOSVI    | SSM     | -20                     | -0.1                  | 44                                | 36   |
| SSM3J35MFV  | π-MOSVI    | VESM    | -20                     | -0.1                  | 44                                | 36   |
| SSM3J36FS   | U-MOSIII   | SSM     | -20                     | -0.33                 | 3.6                               | 36   |
| SSM3J36MFV  | U-MOSIII   | VESM    | -20                     | -0.33                 | 3.6                               | 36   |
| SSM3J36TU   | U-MOSIII   | UFM     | -20                     | -0.33                 | 3.6                               | 36   |
| SSM3J46CTB  | U-MOSVI    | CST3B   | -20                     | -2                    | 0.103                             | 28   |
| SSM3K01T    | π-MOSVI    | TSM     | 30                      | 3.2                   | 0.12                              | 29   |
| SSM3K02T    | π-MOSVI    | TSM     | 30                      | 2.5                   | 0.2                               | 29   |
| SSM3K03FV   | π-MOSVI    | VESM    | 20                      | 0.1                   | 12                                | 36   |
| SSM3K04FS   | π-MOSVI    | SSM     | 20                      | 0.1                   | 12                                | 36   |
| SSM3K04FU   | π-MOSVI    | USM     | 20                      | 0.1                   | 12                                | 36   |
| SSM3K04FV   | π-MOSVI    | VESM    | 20                      | 0.1                   | 12                                | 36   |
| SSM3K05FU   | π-MOSVI    | USM     | 20                      | 0.4                   | 1.2                               | 36   |
| SSM3K09FU   | π-MOSVI    | USM     | 30                      | 0.4                   | 1.2                               | 36   |
| SSM3K101TU  | U-MOSIII   | UFM     | 20                      | 2.2                   | 0.103                             | 29   |
| SSM3K102TU  | U-MOSIII   | UFM     | 20                      | 2.6                   | 0.071                             | 29   |
| SSM3K104TU  | U-MOSIII   | UFM     | 20                      | 3                     | 0.056                             | 29   |
| SSM3K105TU  | π-MOSVI    | UFM     | 30                      | 2.1                   | 0.2                               | 29   |
| SSM3K106TU  | π-MOSVII   | UFM     | 20                      | 1.2                   | 0.53                              | 29   |
| SSM3K107TU  | π-MOSVI    | UFM     | 20                      | 1.5                   | 0.41                              | 29   |
| SSM3K116TU  | U-MOSIII   | UFM     | 30                      | 2.2                   | 0.1                               | 29   |
| SSM3K119TU  | U-MOSIII   | UFM     | 30                      | 2.5                   | 0.074                             | 29   |
| SSM3K121TU  | U-MOSIII   | UFM     | 20                      | 3.2                   | 0.048                             | 29   |
| SSM3K122TU  | U-MOSIII   | UFM     | 20                      | 2                     | 0.123                             | 29   |
| SSM3K123TU  | U-MOSIII   | UFM     | 20                      | 4.2                   | 0.028                             | 29   |
| SSM3K124TU  | π-MOSVII   | UFM     | 30                      | 2.4                   | 0.12                              | 29   |
| SSM3K127TU  | U-MOSIII   | UFM     | 30                      | 2                     | 0.123                             | 29   |
| SSM3K128TU  | U-MOSIII   | UFM     | 30                      | 1.5                   | 0.36                              | 29   |

| Part Number  | Series     | Package | Main Characteristics    |                       |                                   | Page |
|--------------|------------|---------|-------------------------|-----------------------|-----------------------------------|------|
|              |            |         | V <sub>BSS</sub><br>(V) | I <sub>D</sub><br>(A) | R <sub>DS(ON)</sub><br>Max<br>(Ω) |      |
| SSM3K12T     | π-MOSVII   | TSM     | 30                      | 3                     | 0.175                             | 29   |
| SSM3K131TU   | U-MOSIV    | UFM     | 30                      | 6.0                   | 0.0415                            | 29   |
| SSM3K14T     | U-MOSII    | TSM     | 30                      | 4                     | 0.067                             | 29   |
| SSM3K15CT    | π-MOSVI    | CST3    | 30                      | 0.1                   | 7                                 | 36   |
| SSM3K15F     | π-MOSVI    | S-MINI  | 30                      | 0.1                   | 7                                 | 36   |
| SSM3K15FS    | π-MOSVI    | SSM     | 30                      | 0.1                   | 7                                 | 36   |
| SSM3K15FU    | π-MOSVI    | USM     | 30                      | 0.1                   | 7                                 | 36   |
| SSM3K15FV    | π-MOSVI    | VESM    | 30                      | 0.1                   | 7                                 | 36   |
| SSM3K16CT    | π-MOSVI    | CST3    | 20                      | 0.1                   | 15                                | 36   |
| SSM3K16FS    | π-MOSVI    | SSM     | 20                      | 0.1                   | 15                                | 36   |
| SSM3K16FU    | π-MOSVI    | USM     | 20                      | 0.1                   | 15                                | 36   |
| SSM3K16FV    | π-MOSVI    | VESM    | 20                      | 0.1                   | 15                                | 36   |
| SSM3K17FU    | π-MOSV     | USM     | 50                      | 0.1                   | 40                                | 36   |
| SSM3K301T    | U-MOSIII   | TSM     | 20                      | 3.5                   | 0.056                             | 29   |
| SSM3K303T    | π-MOSVII   | TSM     | 30                      | 2.9                   | 0.12                              | 29   |
| SSM3K309T    | U-MOSIII   | TSM     | 20                      | 4.7                   | 0.031                             | 29   |
| SSM3K310T    | U-MOSIII   | TSM     | 20                      | 5                     | 0.028                             | 29   |
| SSM3K315T    | U-MOSIV    | TSM     | 30                      | 6                     | 0.0415                            | 29   |
| SSM3K316T    | U-MOSIII   | TSM     | 30                      | 4                     | 0.065                             | 29   |
| SSM3K318T    | U-MOSIV    | TSM     | 60                      | 2.5                   | 0.145                             | 29   |
| SSM3K320T    | U-MOSIV    | TSM     | 30                      | 4.2                   | 0.077                             | 29   |
| SSM3K35CT    | π-MOSVI    | CST3    | 20                      | 0.18                  | 20                                | 36   |
| SSM3K35FS    | π-MOSVI    | SSM     | 20                      | 0.18                  | 20                                | 36   |
| SSM3K35MFV   | π-MOSVI    | VESM    | 20                      | 0.18                  | 20                                | 36   |
| SSM3K36FS    | U-MOSIII   | SSM     | 20                      | 0.5                   | 1.52                              | 36   |
| SSM3K36MFV   | U-MOSIII   | VESM    | 20                      | 0.5                   | 1.52                              | 36   |
| SSM3K36TU    | U-MOSIII   | UFM     | 20                      | 0.5                   | 1.52                              | 36   |
| SSM3K43FS    | U-MOSIII   | SSM     | 20                      | 0.5                   | 1.52                              | 36   |
| SSM3K44FS    | π-MOSVI    | SSM     | 30                      | 0.1                   | 7                                 | 36   |
| SSM3K44MFV   | π-MOSVI    | VESM    | 30                      | 0.1                   | 7                                 | 36   |
| SSM3K7002AF  | π-MOSV     | S-MINI  | 60                      | 0.2                   | 3.3                               | 36   |
| SSM3K7002AFU | π-MOSV     | USM     | 60                      | 0.2                   | 3.3                               | 36   |
| SSM3K7002BF  | U-MOSIV    | S-MINI  | 60                      | 0.2                   | 3.3                               | 36   |
| SSM3K7002BFS | U-MOSIV    | SSM     | 60                      | 0.2                   | 3.3                               | 36   |
| SSM3K7002BFU | U-MOSIV    | USM     | 60                      | 0.2                   | 3.3                               | 36   |
| SSM3K7002F   | π-MOSVI    | S-MINI  | 60                      | 0.2                   | 3.3                               | 36   |
| SSM3K7002FU  | π-MOSVI    | USM     | 60                      | 0.2                   | 3.3                               | 36   |
| SSM4K27CT    | U-MOSIII   | CST4    | 20                      | 0.5                   | 0.205                             | 29   |
| SSM5G01TU    | U-MOSII    | UFV     | -30                     | -1                    | 0.8                               | 30   |
| SSM5G02TU    | U-MOSII    | UFV     | -12                     | -1                    | 0.16                              | 30   |
| SSM5G04TU    | U-MOSII    | UFV     | -12                     | -1                    | 0.24                              | 30   |
| SSM5G09TU    | U-MOSII    | UFV     | -12                     | -1.5                  | 0.13                              | 30   |
| SSM5G10TU    | U-MOSIII   | UFV     | -20                     | -1.5                  | 0.213                             | 30   |
| SSM5G11TU    | U-MOSIII-H | UFV     | -30                     | -1.4                  | 0.403                             | 30   |
| SSM5H01TU    | U-MOSII    | UFV     | 30                      | 1.4                   | 0.45                              | 30   |
| SSM5H03TU    | U-MOSII    | UFV     | 12                      | 1.4                   | 0.3                               | 30   |
| SSM5H05TU    | U-MOSIII   | UFV     | 20                      | 1.5                   | 0.16                              | 30   |
| SSM5H07TU    | π-MOSVII   | UFV     | 20                      | 1.2                   | 0.54                              | 30   |
| SSM5H08TU    | U-MOSIII   | UFV     | 20                      | 1.5                   | 0.16                              | 30   |
| SSM5H10TU    | U-MOSIII   | UFV     | 20                      | 1.6                   | 0.119                             | 30   |
| SSM5H11TU    | U-MOSIII   | UFV     | 30                      | 1.6                   | 0.182                             | 30   |
| SSM5H12TU    | U-MOSIII   | UFV     | 30                      | 1.9                   | 0.133                             | 30   |
| SSM5H14F     | U-MOSIII   | SMV     | 30                      | 3                     | 0.078                             | 31   |
| SSM5N03FE    | π-MOSVI    | ES6     | 20                      | 0.1                   | 12                                | 36   |
| SSM5N05FU    | π-MOSVI    | US6     | 20                      | 0.4                   | 1.2                               | 36   |

| Part Number | Series   | Package | Main Characteristics    |                       |                                   | Page |
|-------------|----------|---------|-------------------------|-----------------------|-----------------------------------|------|
|             |          |         | V <sub>BSS</sub><br>(V) | I <sub>D</sub><br>(A) | R <sub>DS(ON)</sub><br>Max<br>(Ω) |      |
| SSM5N15FE   | π-MOSVI  | ES6     | 30                      | 0.1                   | 7                                 | 36   |
| SSM5N15FU   | π-MOSVI  | US6     | 30                      | 0.1                   | 7                                 | 36   |
| SSM5N16FE   | π-MOSVI  | ES6     | 20                      | 0.1                   | 15                                | 36   |
| SSM5N16FU   | π-MOSVI  | US6     | 20                      | 0.1                   | 15                                | 36   |
| SSM5P05FU   | π-MOSVI  | US6     | -20                     | -0.2                  | 4                                 | 36   |
| SSM5P15FE   | π-MOSVI  | ES6     | -30                     | -0.1                  | 32                                | 36   |
| SSM5P15FU   | π-MOSVI  | US6     | -30                     | -0.1                  | 32                                | 36   |
| SSM5P16FE   | π-MOSVI  | ES6     | -20                     | -0.1                  | 45                                | 36   |
| SSM5P16FU   | π-MOSVI  | US6     | -20                     | -0.1                  | 45                                | 36   |
| SSM6E01TU   | U-MOSIII | UF6     | -12                     | -1                    | 0.16                              | 30   |
| SSM6E02TU   | U-MOSIV  | UF6     | -20                     | -1.8                  | 0.136                             | 30   |
| SSM6E03TU   | U-MOSIII | UF6     | -20                     | -1.8                  | 0.144                             | 30   |
| SSM6J06FU   | π-MOSVI  | US6     | -20                     | -0.65                 | 0.5                               | 28   |
| SSM6J07FU   | π-MOSVI  | US6     | -30                     | -0.8                  | 0.8                               | 28   |
| SSM6J08FU   | U-MOSII  | US6     | -20                     | -1.3                  | 0.18                              | 28   |
| SSM6J205FE  | U-MOSIII | ES6     | -20                     | -0.8                  | 0.234                             | 28   |
| SSM6J206FE  | U-MOSIII | ES6     | -20                     | -2                    | 0.13                              | 28   |
| SSM6J207FE  | U-MOSII  | ES6     | -30                     | -1.3                  | 0.491                             | 28   |
| SSM6J21TU   | U-MOSIII | UF6     | -12                     | -3                    | 0.05                              | 28   |
| SSM6J212FE  | U-MOSVI  | ES6     | -20                     | -3.3                  | 0.0434                            | 28   |
| SSM6J23FE   | U-MOSIII | ES6     | -12                     | -1.2                  | 0.16                              | 28   |
| SSM6J25FE   | U-MOSIII | ES6     | -20                     | -0.5                  | 0.26                              | 28   |
| SSM6J26FE   | U-MOSIII | ES6     | -20                     | -0.5                  | 0.23                              | 28   |
| SSM6J401TU  | U-MOSIII | UF6     | -30                     | -2.5                  | 0.145                             | 28   |
| SSM6J402TU  | U-MOSIII | UF6     | -30                     | -2                    | 0.225                             | 28   |
| SSM6J409TU  | U-MOSV   | UF6     | -20                     | -9.5                  | 0.0221                            | 28   |
| SSM6J50TU   | U-MOSIV  | UF6     | -20                     | -2.5                  | 0.064                             | 28   |
| SSM6J51TU   | U-MOSIV  | UF6     | -12                     | -4                    | 0.054                             | 28   |
| SSM6J53FE   | U-MOSIV  | ES6     | -20                     | -1.8                  | 0.136                             | 28   |
| SSM6K06FU   | π-MOSVI  | US6     | 20                      | 1.1                   | 0.16                              | 29   |
| SSM6K07FU   | π-MOSVI  | US6     | 30                      | 1.5                   | 0.22                              | 29   |
| SSM6K08FU   | U-MOSII  | US6     | 20                      | 1.6                   | 0.105                             | 29   |
| SSM6K18TU   | U-MOSIII | UF6     | 20                      | 4                     | 0.04                              | 29   |
| SSM6K202FE  | U-MOSIII | ES6     | 30                      | 2.3                   | 0.085                             | 29   |
| SSM6K203FE  | U-MOSIII | ES6     | 20                      | 2.8                   | 0.061                             | 29   |
| SSM6K204FE  | U-MOSIII | ES6     | 20                      | 2                     | 0.126                             | 29   |
| SSM6K208FE  | U-MOSIII | ES6     | 30                      | 1.9                   | 0.133                             | 29   |
| SSM6K210FE  | U-MOSIII | ES6     | 30                      | 1.4                   | 0.371                             | 29   |
| SSM6K211FE  | U-MOSIII | ES6     | 20                      | 3.2                   | 0.047                             | 29   |
| SSM6K22FE   | U-MOSIII | ES6     | 20                      | 1.4                   | 0.17                              | 29   |
| SSM6K24FE   | U-MOSIII | ES6     | 30                      | 0.5                   | 0.145                             | 29   |
| SSM6K25FE   | U-MOSIII | ES6     | 20                      | 0.5                   | 0.145                             | 29   |
| SSM6K30FE   | π-MOSVII | ES6     | 20                      | 1.2                   | 0.42                              | 29   |
| SSM6K31FE   | π-MOSVII | ES6     | 20                      | 1.2                   | 0.54                              | 29   |
| SSM6K32TU   | π-MOSV   | UF6     | 60                      | 2                     | 0.44                              | 29   |
| SSM6K34TU   | U-MOSIII | UF6     | 30                      | 3                     | 0.077                             | 29   |
| SSM6K403TU  | U-MOSIII | UF6     | 20                      | 4.2                   | 0.028                             | 29   |
| SSM6K404TU  | U-MOSIII | UF6     | 20                      | 3                     | 0.055                             | 29   |
| SSM6K405TU  | U-MOSIII | UF6     | 20                      | 2                     | 0.126                             | 29   |
| SSM6K406TU  | U-MOSIV  | UF6     | 30                      | 4.4                   | 0.0385                            | 29   |
| SSM6K407TU  | π-MOSV   | UF6     | 60                      | 2                     | 0.44                              | 29   |
| SSM6L05FU   | π-MOSVI  | US6     | 20                      | 0.4                   | 1.2                               | 36   |
| SSM6L09FU   | π-MOSVI  | US6     | 30                      | 0.4                   | 1.2                               | 36   |
| SSM6L10TU   | U-MOSIII | UF6     | 20                      | 0.5                   | 0.145                             | 30   |
| SSM6L11TU   | U-MOSIII | UF6     | 20                      | 0.5                   | 0.145                             | 30   |

| Part Number  | Series       | Package     | Main Characteristics    |                       |  | Page  |
|--------------|--------------|-------------|-------------------------|-----------------------|--|-------|
|              |              |             | V <sub>DSS</sub><br>(V) | I <sub>D</sub><br>(A) | R <sub>DS(ON)</sub><br>Max<br>( $\Omega$ ) |       |
| SSM6L12TU    | U-MOSIII     | UF6         | 30                      | 0.5                   | 0.145                                      | 30    |
| SSM6L13TU    | U-MOSIII     | UF6         | 20                      | 0.8                   | 0.143                                      | 30    |
| SSM6L16FE    | $\pi$ -MOSVI | ES6         | 20                      | 0.1                   | 15   | 36    |
| SSM6L35FE    | $\pi$ -MOSVI | ES6         | 20                      | 0.18                  | 20   | 36    |
| SSM6L35FU    | $\pi$ -MOSVI | US6         | 20                      | 0.18                  | 20   | 36    |
| SSM6L36FE    | U-MOSIII     | ES6         | 20                      | 0.5                   | 1.52                                       | 36    |
| SSM6L36TU    | U-MOSIII     | UF6         | 20                      | 0.5                   | 1.52                                       | 36    |
| SSM6L39TU    | U-MOSIII     | UF6         | 20                      | 1.6                   | 0.119                                      | 30    |
| SSM6L40TU    | U-MOSIII     | UF6         | 30                      | 1.6                   | 0.182                                      | 30    |
| SSM6N03FE    | $\pi$ -MOSVI | ES6         | 20                      | 0.1                   | 12   | 36    |
| SSM6N04FU    | $\pi$ -MOSVI | US6         | 20                      | 0.1                   | 12   | 36    |
| SSM6N05FU    | $\pi$ -MOSVI | US6         | 20                      | 0.4                   | 1.2  | 36    |
| SSM6N09FU    | $\pi$ -MOSVI | US6         | 30                      | 0.4                   | 1.2  | 36    |
| SSM6N15FE    | $\pi$ -MOSVI | ES6         | 30                      | 0.1                   | 7  | 36    |
| SSM6N15FU    | $\pi$ -MOSVI | US6         | 30                      | 0.1                   | 7  | 36    |
| SSM6N16FE    | $\pi$ -MOSVI | ES6         | 20                      | 0.1                   | 15   | 36    |
| SSM6N16FU    | $\pi$ -MOSVI | US6         | 20                      | 0.1                   | 15   | 36    |
| SSM6N17FU    | $\pi$ -MOSV  | US6         | 50                      | 0.1                   | 40   | 36    |
| SSM6N24TU    | U-MOSIII     | UF6         | 30                      | 0.5                   | 0.145                                      | 30    |
| SSM6N25TU    | U-MOSIII     | UF6         | 20                      | 0.5                   | 0.145                                      | 30    |
| SSM6N29TU    | U-MOSIII     | UF6         | 20                      | 0.8                   | 0.143                                      | 30    |
| SSM6N35FE    | $\pi$ -MOSVI | ES6         | 20                      | 0.18                  | 20   | 36    |
| SSM6N35FU    | $\pi$ -MOSVI | US6         | 20                      | 0.18                  | 20   | 36    |
| SSM6N36FE    | U-MOSIII     | ES6         | 20                      | 0.5                   | 1.52                                       | 36    |
| SSM6N36TU    | U-MOSIII     | UF6         | 20                      | 0.5                   | 1.52                                       | 36    |
| SSM6N37CTD   | U-MOSIII     | CST6D       | 20                      | 0.25                  | 5.6  | 36    |
| SSM6N39TU    | U-MOSIII     | UF6         | 20                      | 1.6                   | 0.119                                      | 30    |
| SSM6N40TU    | U-MOSIII     | UF6         | 30                      | 1.6                   | 0.182                                      | 30    |
| SSM6N42FE    | U-MOSIII     | ES6         | 20                      | 0.77                  | 0.26                                       | 30    |
| SSM6N43FU    | U-MOSIII     | US6         | 20                      | 0.5                   | 1.52                                       | 36    |
| SSM6N44FE    | $\pi$ -MOSVI | ES6         | 30                      | 0.1                   | 7  | 36    |
| SSM6N44FU    | $\pi$ -MOSVI | US6         | 30                      | 0.1                   | 7  | 36    |
| SSM6N7002AFU | $\pi$ -MOSV  | US6         | 60                      | 0.2                   | 3.3  | 36    |
| SSM6N7002BFE | U-MOSIV      | ES6         | 60                      | 0.2                   | 3.3  | 36    |
| SSM6N7002BFU | U-MOSIV      | US6         | 60                      | 0.2                   | 3.3  | 36    |
| SSM6N7002FU  | $\pi$ -MOSVI | US6         | 60                      | 0.2                   | 3.3  | 36    |
| SSM6P05FU    | $\pi$ -MOSVI | US6         | -20                     | -0.2                  | 4  | 36    |
| SSM6P09FU    | $\pi$ -MOSVI | US6         | -30                     | -0.2                  | 4.2  | 36    |
| SSM6P15FE    | $\pi$ -MOSVI | ES6         | -30                     | -0.1                  | 32   | 36    |
| SSM6P15FU    | $\pi$ -MOSVI | US6         | -30                     | -0.1                  | 32   | 36    |
| SSM6P16FE    | $\pi$ -MOSVI | ES6         | -20                     | -0.1                  | 45   | 36    |
| SSM6P16FU    | $\pi$ -MOSVI | US6         | -20                     | -0.1                  | 45   | 36    |
| SSM6P25TU    | U-MOSIII     | UF6         | -20                     | -0.5                  | 0.26                                       | 30    |
| SSM6P26TU    | U-MOSIII     | UF6         | -20                     | -0.5                  | 0.23                                       | 30    |
| SSM6P28TU    | U-MOSIII     | UF6         | -20                     | -0.8                  | 0.234                                      | 30    |
| SSM6P35FE    | $\pi$ -MOSVI | ES6         | -20                     | -0.1                  | 44   | 36    |
| SSM6P35FU    | $\pi$ -MOSVI | US6         | -20                     | -0.1                  | 44   | 36    |
| SSM6P36FE    | U-MOSIII     | ES6         | -20                     | -0.33                 | 3.6  | 36    |
| SSM6P36TU    | U-MOSIII     | UF6         | -20                     | -0.33                 | 3.6  | 36    |
| SSM6P39TU    | U-MOSIII     | UF6         | -20                     | -1.5                  | 0.213                                      | 30    |
| SSM6P40TU    | U-MOSIII     | UF6         | -30                     | -1.4                  | 0.403                                      | 30    |
| SSM6P41FE    | U-MOSV       | ES6         | -20                     | -0.72                 | 0.3  | 30    |
| SSM6P54TU    | U-MOSIV      | UF6         | -20                     | -1.2                  | 0.228                                      | 30    |
| TJ20A10M3    | U-MOSVI      | TO-220SIS   | -100                    | -20                   | 0.09                                       | 38    |
| TJ70A06J3    | U-MOSIII     | TO-220SIS   | -60                     | -70                   | 0.008                                      | 38    |
| TJ120F06J3   | U-MOSIII     | TO-220SM(W) | -60                     | -120                  | 0.008                                      | 37,38 |

| Part Number | Series        | Package     | Main Characteristics    |                       |  | Page  |
|-------------|---------------|-------------|-------------------------|-----------------------|--|-------|
|             |               |             | V <sub>DSS</sub><br>(V) | I <sub>D</sub><br>(A) | R <sub>DS(ON)</sub><br>Max<br>( $\Omega$ ) |       |
| TK100F04K3  | U-MOSIV       | TO-220SM(W) | 40                      | 100                   | 0.003                                      | 37,38 |
| TK100F04K3L | U-MOSIV       | TO-220SM(W) | 40                      | 100                   | 0.003                                      | 37,38 |
| TK100F06K3  | U-MOSIV       | TO-220SM(W) | 60                      | 100                   | 0.005                                      | 37,38 |
| TK10A50D    | $\pi$ -MOSVII | TO-220SIS   | 500                     | 10                    | 0.72                                       | 40    |
| TK10A60D    | $\pi$ -MOSVII | TO-220SIS   | 600                     | 10                    | 0.75                                       | 40    |
| TK11A50D    | $\pi$ -MOSVII | TO-220SIS   | 500                     | 11                    | 0.6  | 40    |
| TK11A55D    | $\pi$ -MOSVII | TO-220SIS   | 550                     | 11                    | 0.63                                       | 40    |
| TK11A60D    | $\pi$ -MOSVII | TO-220SIS   | 600                     | 11                    | 0.65                                       | 40    |
| TK12A50D    | $\pi$ -MOSVII | TO-220SIS   | 500                     | 12                    | 0.52                                       | 40    |
| TK12A53D    | $\pi$ -MOSVII | TO-220SIS   | 525                     | 12                    | 0.58                                       | 40    |
| TK12A55D    | $\pi$ -MOSVII | TO-220SIS   | 550                     | 12                    | 0.57                                       | 40    |
| TK12A60D    | $\pi$ -MOSVII | TO-220SIS   | 600                     | 12                    | 0.55                                       | 40    |
| TK12A60U    | DTMOSII       | TO-220SIS   | 600                     | 12                    | 0.4  | 41    |
| TK12D60U    | DTMOSII       | TO-220(W)   | 600                     | 12                    | 0.4  | 41    |
| TK12J55D    | $\pi$ -MOSVII | TO-3P(N)    | 550                     | 12                    | 0.57                                       | 40    |
| TK12J60U    | DTMOSII       | TO-3P(N)    | 600                     | 12                    | 0.4  | 41    |
| TK12X53D    | $\pi$ -MOSVII | TFP         | 550                     | 12                    | 0.58                                       | 40    |
| TK130F06K3  | U-MOSIV       | TO-220SM(W) | 60                      | 130                   | 0.0034                                     | 37    |
| TK13A45D    | $\pi$ -MOSVII | TO-220SIS   | 450                     | 13                    | 0.46                                       | 40    |
| TK13A50D    | $\pi$ -MOSVII | TO-220SIS   | 500                     | 13                    | 0.4  | 40    |
| TK13A50DA   | $\pi$ -MOSVII | TO-220SIS   | 500                     | 12.5                  | 0.47                                       | 40    |
| TK13A55DA   | $\pi$ -MOSVII | TO-220SIS   | 550                     | 12.5                  | 0.48                                       | 40    |
| TK13A60D    | $\pi$ -MOSVII | TO-220SIS   | 600                     | 13                    | 0.43                                       | 40    |
| TK13A65U    | DTMOSII       | TO-220SIS   | 650                     | 13                    | 0.38                                       | 41    |
| TK14A55D    | $\pi$ -MOSVII | TO-220SIS   | 550                     | 14                    | 0.37                                       | 40    |
| TK150F04K3  | U-MOSIV       | TO-220SM(W) | 40                      | 150                   | 0.0021                                     | 37    |
| TK150F04K3L | U-MOSIV       | TO-220SM(W) | 40                      | 150                   | 0.0021                                     | 37    |
| TK15A50D    | $\pi$ -MOSVII | TO-220SIS   | 500                     | 15                    | 0.3  | 40    |
| TK15A60D    | $\pi$ -MOSVII | TO-220SIS   | 600                     | 15                    | 0.37                                       | 40    |
| TK15A60U    | DTMOSII       | TO-220SIS   | 600                     | 15                    | 0.3  | 41    |
| TK15D60U    | DTMOSII       | TO-220(W)   | 600                     | 15                    | 0.3  | 41    |
| TK15J50D    | $\pi$ -MOSVII | TO-3P(N)    | 500                     | 15                    | 0.4  | 40    |
| TK15J60T    | DTMOSI        | TO-3P(N)    | 600                     | 15                    | 0.28                                       | 41    |
| TK15J60U    | DTMOSII       | TO-3P(N)    | 600                     | 15                    | 0.3  | 41    |
| TK16J55D    | $\pi$ -MOSVII | TO-3P(N)    | 550                     | 16                    | 0.37                                       | 40    |
| TK18A50D    | $\pi$ -MOSVII | TO-220SIS   | 500                     | 18                    | 0.27                                       | 40    |
| TK20A60T    | DTMOSI        | TO-220SIS   | 600                     | 20                    | 0.19                                       | 41    |
| TK20A60U    | DTMOSII       | TO-220SIS   | 600                     | 20                    | 0.19                                       | 41    |
| TK20D60T    | DTMOSI        | TO-220(W)   | 600                     | 20                    | 0.19                                       | 41    |
| TK20D60U    | DTMOSII       | TO-220(W)   | 600                     | 20                    | 0.19                                       | 41    |
| TK20J50D    | $\pi$ -MOSVII | TO-3P(N)    | 500                     | 20                    | 0.27                                       | 40    |
| TK20J60T    | DTMOSI        | TO-3P(N)    | 600                     | 20                    | 0.19                                       | 41    |
| TK20J60U    | DTMOSII       | TO-3P(N)    | 600                     | 20                    | 0.19                                       | 41    |
| TK25A10K3   | U-MOSIV       | TO-220SIS   | 100                     | 25                    | 0.04                                       | 38    |
| TK2Q60D     | $\pi$ -MOSVII | NewPW-Mold2 | 600                     | 2                     | 5  | 40    |
| TK30A06J3A  | U-MOSIII      | TO-220SIS   | 60                      | 30                    | 0.026                                      | 38    |
| TK3A60DA    | $\pi$ -MOSVII | TO-220SIS   | 600                     | 2.5                   | 2.8  | 40    |
| TK40A08K3   | U-MOSIV       | TO-220SIS   | 75                      | 40                    | 0.009                                      | 39    |
| TK40A10J1   | U-MOSIII-H    | TO-220SIS   | 100                     | 40                    | 0.015                                      | 39    |
| TK40A10K3   | U-MOSIV       | TO-220SIS   | 100                     | 40                    | 0.015                                      | 39    |
| TK40D10J1   | U-MOSIII-H    | TO-220(W)   | 100                     | 40                    | 0.015                                      | 39    |
| TK40J60T    | DTMOSI        | TO-3P(N)    | 600                     | 40                    | 0.08                                       | 41    |
| TK40P03M1   | U-MOSVI-H     | DPAK        | 30                      | 40                    | 0.0108                                     | 35    |
| TK40P04M1   | U-MOSVI-H     | DPAK        | 40                      | 40                    | 0.0103                                     | 35    |
| TK40X10J1   | U-MOSIII-H    | TFP         | 100                     | 40                    | 0.02                                       | 38,39 |
| TK4A50D     | $\pi$ -MOSVII | TO-220SIS   | 500                     | 4                     | 2  | 40    |

| Part Number | Series     | Package     | Main Characteristics    |                       |                                   | Page  |
|-------------|------------|-------------|-------------------------|-----------------------|-----------------------------------|-------|
|             |            |             | V <sub>DSS</sub><br>(V) | I <sub>D</sub><br>(A) | R <sub>DS(ON)</sub><br>Max<br>(Ω) |       |
| TK4A53D     | π-MOSVII   | TO-220SIS   | 525                     | 4                     | 1.7                               | 40    |
| TK4A55D     | π-MOSVII   | TO-220SIS   | 550                     | 4                     | 1.9                               | 40    |
| TK4A55DA    | π-MOSVII   | TO-220SIS   | 550                     | 3.5                   | 2.45                              | 40    |
| TK4A60D     | π-MOSVII   | TO-220SIS   | 600                     | 4                     | 1.7                               | 40    |
| TK4A60DA    | π-MOSVII   | TO-220SIS   | 600                     | 3.5                   | 2.2                               | 40    |
| TK4A60DB    | π-MOSVII   | TO-220SIS   | 600                     | 3.7                   | 2                                 | 40    |
| TK50F15J1   | U-MOSIII   | TO-220SM(W) | 150                     | 50                    | 0.03                              | 37,38 |
| TK50P03M1   | U-MOSVI-H  | DPAK        | 30                      | 50                    | 0.0075                            | 35    |
| TK50P04M1   | U-MOSVI-H  | DPAK        | 40                      | 50                    | 0.0087                            | 35    |
| TK50X15J1   | U-MOSIII-H | TFP         | 150                     | 50                    | 0.03                              | 39    |
| TK55A10J1   | U-MOSIII-H | TO-220SIS   | 100                     | 55                    | 0.0105                            | 39    |
| TK55D10J1   | U-MOSIII-H | TO-220(W)   | 100                     | 55                    | 0.0105                            | 39    |
| TK5A50D     | π-MOSVII   | TO-220SIS   | 500                     | 5                     | 1.5                               | 40    |
| TK5A53D     | π-MOSVII   | TO-220SIS   | 525                     | 5                     | 1.5                               | 40    |
| TK5A55D     | π-MOSVII   | TO-220SIS   | 550                     | 5                     | 1.88                              | 40    |
| TK5A65D     | π-MOSVII   | TO-220SIS   | 650                     | 5                     | 1.45                              | 40    |
| TK60A08J1   | U-MOSIII-H | TO-220SIS   | 75                      | 60                    | 0.0078                            | 39    |
| TK60D08J1   | U-MOSIII-H | TO-220(W)   | 75                      | 60                    | 0.0078                            | 39    |
| TK6A50D     | π-MOSVII   | TO-220(W)   | 500                     | 6                     | 1.4                               | 40    |
| TK6A53D     | π-MOSVII   | TO-220SIS   | 525                     | 6                     | 1.3                               | 40    |
| TK6A55DA    | π-MOSVII   | TO-220SIS   | 550                     | 5.5                   | 1.48                              | 40    |
| TK6A60D     | π-MOSVII   | TO-220SIS   | 600                     | 6                     | 1.25                              | 40    |
| TK6A65D     | π-MOSVII   | TO-220SIS   | 650                     | 6                     | 1.11                              | 40    |
| TK6P53D     | π-MOSVII   | DPAK        | 525                     | 6                     | 1.3                               | 40    |
| TK70A06J1   | U-MOSIII-H | TO-220SIS   | 60                      | 70                    | 0.0064                            | 39    |
| TK70D06J1   | U-MOSIII-H | TO-220(W)   | 60                      | 70                    | 0.0064                            | 39    |
| TK70J04J3   | U-MOSIII   | TO-3P(N)    | 40                      | 70                    | 0.0038                            | 38    |
| TK70X04K3   | U-MOSIV    | TFP         | 40                      | 70                    | 0.0056                            | 38    |
| TK70X04K3L  | U-MOSIV    | TFP         | 40                      | 70                    | 0.0056                            | -     |
| TK70X04K3Z  | U-MOSIV    | TFP         | 40                      | 70                    | 0.0056                            | 38    |
| TK70X06K3   | U-MOSIV    | TFP         | 60                      | 70                    | 0.008                             | 38    |
| TK7A50D     | π-MOSVII   | TO-220SIS   | 500                     | 7                     | 1.22                              | 40    |
| TK80A08K3   | U-MOSIV    | TO-220SIS   | 75                      | 80                    | 0.0045                            | 39    |
| TK80D08K3   | U-MOSIV    | TO-220(W)   | 75                      | 80                    | 0.0045                            | 39    |
| TK80X04K3   | U-MOSIV    | TFP         | 40                      | 80                    | 0.0035                            | 38    |
| TK8A50D     | π-MOSVII   | TO-220SIS   | 500                     | 8                     | 0.85                              | 40    |
| TK8A50DA    | π-MOSVII   | TO-220SIS   | 500                     | 7.5                   | 1.0                               | 40    |
| TK8A55DA    | π-MOSVII   | TO-220SIS   | 550                     | 7.5                   | 1.07                              | 40    |
| TK8A60DA    | π-MOSVII   | TO-220SIS   | 600                     | 7.5                   | 1                                 | 40    |
| TK8A65D     | π-MOSVII   | TO-220SIS   | 650                     | 8                     | 0.84                              | 40    |
| TK9A55DA    | π-MOSVII   | TO-220SIS   | 550                     | 8.5                   | 0.86                              | 40    |
| TPC6004     | U-MOSIII   | VS-6        | 20                      | 6                     | 0.024                             | 31    |
| TPC6005     | U-MOSIII   | VS-6        | 30                      | 6                     | 0.028                             | 31    |
| TPC6006-H   | U-MOSIII-H | VS-6        | 40                      | 3.9                   | 0.075                             | 24,31 |
| TPC6007-H   | U-MOSIII-H | VS-6        | 30                      | 5                     | 0.054                             | 24,31 |
| TPC6011     | U-MOSIV    | VS-6        | 30                      | 6                     | 0.020                             | 31    |
| TPC6103     | U-MOSIII   | VS-6        | -12                     | -5.5                  | 0.035                             | 31    |
| TPC6105     | U-MOSIII   | VS-6        | -20                     | -2.7                  | 0.11                              | 31    |
| TPC6107     | U-MOSIV    | VS-6        | -20                     | -4.5                  | 0.055                             | 31    |
| TPC6108     | U-MOSIV    | VS-6        | -30                     | -4.5                  | 0.06                              | 31    |
| TPC6109-H   | U-MOSIII-H | VS-6        | -30                     | -5                    | 0.059                             | 24,31 |
| TPC6111     | U-MOSV     | VS-6        | -20                     | -5.5                  | 0.04                              | 31    |
| TPC6201     | U-MOSII    | VS-6        | 30                      | 2.5                   | 0.095                             | -     |
| TPC8012-H   | π-MOSV     | SOP-8       | 200                     | 1.8                   | 0.4                               | 34    |
| TPC8014     | U-MOSIII   | SOP-8       | 30                      | 11                    | 0.014                             | 27    |
| TPC8017-H   | U-MOSIII-H | SOP-8       | 30                      | 15                    | 0.0066                            | -     |

| Part Number | Series              | Package | Main Characteristics    |                       |                                   | Page  |
|-------------|---------------------|---------|-------------------------|-----------------------|-----------------------------------|-------|
|             |                     |         | V <sub>DSS</sub><br>(V) | I <sub>D</sub><br>(A) | R <sub>DS(ON)</sub><br>Max<br>(Ω) |       |
| TPC8018-H   | U-MOSIII-H          | SOP-8   | 30                      | 18                    | 0.0046                            | -     |
| TPC8020-H   | U-MOSIII-H          | SOP-8   | 30                      | 13                    | 0.009                             | -     |
| TPC8021-H   | U-MOSIII-H          | SOP-8   | 30                      | 11                    | 0.017                             | 24,33 |
| TPC8022-H   | U-MOSIII-H          | SOP-8   | 40                      | 7.5                   | 0.027                             | 24,34 |
| TPC8025     | U-MOSIV             | SOP-8   | 30                      | 11                    | 0.009                             | 27,33 |
| TPC8026     | U-MOSIV             | SOP-8   | 30                      | 13                    | 0.0066                            | 27,33 |
| TPC8027     | U-MOSIV             | SOP-8   | 30                      | 18                    | 0.0027                            | 27,34 |
| TPC8028     | U-MOSIV             | SOP-8   | 30                      | 18                    | 0.0043                            | 27,34 |
| TPC8029     | U-MOSIV             | SOP-8   | 30                      | 18                    | 0.0038                            | 27,34 |
| TPC8030     | U-MOSIV             | SOP-8   | 30                      | 11                    | 0.0095                            | 27,33 |
| TPC8031-H   | U-MOSV-H            | SOP-8   | 30                      | 11                    | 0.0133                            | 24    |
| TPC8032-H   | U-MOSV-H            | SOP-8   | 30                      | 15                    | 0.0065                            | 24,33 |
| TPC8033-H   | U-MOSV-H            | SOP-8   | 30                      | 17                    | 0.0053                            | 24,33 |
| TPC8034-H   | U-MOSV-H            | SOP-8   | 30                      | 18                    | 0.0035                            | 24,34 |
| TPC8035-H   | U-MOSVI-H           | SOP-8   | 30                      | 18                    | 0.0032                            | 24,34 |
| TPC8036-H   | U-MOSVI-H           | SOP-8   | 30                      | 18                    | 0.0045                            | 24,34 |
| TPC8037-H   | U-MOSV-H            | SOP-8   | 30                      | 12                    | 0.0114                            | 24,33 |
| TPC8038-H   | U-MOSV-H            | SOP-8   | 30                      | 12                    | 0.0114                            | 24,33 |
| TPC8039-H   | U-MOSVI-H           | SOP-8   | 30                      | 17                    | 0.006                             | 24,33 |
| TPC8040-H   | U-MOSVI-H           | SOP-8   | 30                      | 13                    | 0.0097                            | 24,33 |
| TPC8045-H   | U-MOSVI-H           | SOP-8   | 40                      | 18                    | 0.0039                            | 24,34 |
| TPC8046-H   | U-MOSVI-H           | SOP-8   | 40                      | 18                    | 0.0057                            | 24,34 |
| TPC8047-H   | U-MOSVI-H           | SOP-8   | 40                      | 16                    | 0.0076                            | 24,34 |
| TPC8048-H   | U-MOSVI-H           | SOP-8   | 60                      | 16                    | 0.0069                            | 25,34 |
| TPC8049-H   | U-MOSVI-H           | SOP-8   | 60                      | 13                    | 0.0107                            | 25,34 |
| TPC8050-H   | U-MOSVI-H           | SOP-8   | 60                      | 11                    | 0.0145                            | 25,34 |
| TPC8051-H   | U-MOSVI-H           | SOP-8   | 80                      | 13                    | 0.0097                            | 25,34 |
| TPC8052-H   | U-MOSVI-H           | SOP-8   | 40                      | 12                    | 0.0115                            | 24,34 |
| TPC8053-H   | U-MOSVI-H           | SOP-8   | 60                      | 9                     | 0.0225                            | 25,34 |
| TPC8107     | U-MOSIII            | SOP-8   | -30                     | -13                   | 0.007                             | -     |
| TPC8109     | U-MOSIII            | SOP-8   | -30                     | -10                   | 0.02                              | -     |
| TPC8110     | U-MOSIII            | SOP-8   | -40                     | -8                    | 0.025                             | 34    |
| TPC8111     | U-MOSIV             | SOP-8   | -30                     | -11                   | 0.012                             | 34    |
| TPC8112     | U-MOSIII            | SOP-8   | -30                     | -13                   | 0.006                             | -     |
| TPC8113     | U-MOSIV             | SOP-8   | -30                     | -11                   | 0.01                              | 27,34 |
| TPC8114     | U-MOSIV             | SOP-8   | -30                     | -18                   | 0.0045                            | 27,34 |
| TPC8115     | U-MOSIV             | SOP-8   | -20                     | -10                   | 0.01                              | 27,34 |
| TPC8116-H   | U-MOSIII-H          | SOP-8   | -40                     | -7.5                  | 0.03                              | 25,34 |
| TPC8117     | U-MOSV              | SOP-8   | -30                     | -18                   | 0.0039                            | 27,34 |
| TPC8118     | U-MOSV              | SOP-8   | 30                      | 13                    | 0.007                             | 27,34 |
| TPC8120     | U-MOSVI             | SOP-8   | -30                     | -18                   | 0.0032                            | 27,34 |
| TPC8122     | U-MOSV              | SOP-8   | -30                     | -11                   | 0.008                             | 27,34 |
| TPC8123     | U-MOSVI             | SOP-8   | -30                     | -11                   | 0.0095                            | 27,34 |
| TPC8207     | U-MOSIII            | SOP-8   | 20                      | 6                     | 0.02                              | 27,34 |
| TPC8208     | U-MOSIII            | SOP-8   | 20                      | 5                     | 0.05                              | 27,34 |
| TPC8210     | U-MOSIII            | SOP-8   | 30                      | 8                     | 0.015                             | 27,34 |
| TPC8211     | U-MOSIII            | SOP-8   | 30                      | 5.5                   | 0.036                             | 27,34 |
| TPC8212-H   | U-MOSIII-H          | SOP-8   | 30                      | 6                     | 0.021                             | 34    |
| TPC8213-H   | U-MOSIII-H          | SOP-8   | 60                      | 5                     | 0.05                              | 25,34 |
| TPC8214-H   | U-MOSIII-H          | SOP-8   | 100                     | 2.2                   | 0.18                              | 25,34 |
| TPC8218-H   | U-MOSVI-H           | SOP-8   | 60                      | 3.8                   | 0.057                             | 25,34 |
| TPC8404     | π-MOSV/π-MOSV       | SOP-8   | -250/250                | 1.1/-0.9              | 1.7/2.55                          | 34    |
| TPC8405     | U-MOSIV/U-MOSIII    | SOP-8   | -30/30                  | -4.5/6                | 0.027                             | 27,34 |
| TPC8406-H   | U-MOSIII-H          | SOP-8   | 40                      | 6.5                   | 0.03                              | 25,34 |
| TPC8406-H   | U-MOSIII-H          | SOP-8   | -40                     | -6.5                  | 0.025                             | 25,34 |
| TPC8A01     | High-speed U-MOSIII | SOP-8   | 30                      | 6                     | 0.018                             | 34    |

| Part Number | Series        | Package     | Main Characteristics    |                       |  | Page  |
|-------------|---------------|-------------|-------------------------|-----------------------|--|-------|
|             |               |             | V <sub>bss</sub><br>(V) | I <sub>D</sub><br>(A) | R <sub>DS(ON)</sub><br>Max<br>( $\Omega$ ) |       |
| TPC8A01     | U-MOSIII      | SOP-8       | 30                      | 8.5/1                 | 0.0056                                     | 34    |
| TPC8A02-H   | U-MOSIII-H    | SOP-8       | 30                      | 16/1                  | 0.0056                                     | –     |
| TPC8A03-H   | U-MOSV-H      | SOP-8       | 30                      | 17/1                  | 0.0036                                     | 25,34 |
| TPC8A04-H   | U-MOSV-H      | SOP-8       | 30                      | 18/1                  | 0.0133                                     | 25,34 |
| TPC8A05-H   | U-MOSV-H      | SOP-8       | 30                      | 10/1                  | 0.0066                                     | 25,34 |
| TPC8A06-H   | U-MOSV-H      | SOP-8       | 30                      | 12                    | 0.0101                                     | 25,34 |
| TPCA8003-H  | U-MOSIII-H    | SOP Advance | 30                      | 35                    | 0.0046                                     | –     |
| TPCA8004-H  | U-MOSIII-H    | SOP Advance | 30                      | 40                    | 0.009                                      | –     |
| TPCA8005-H  | U-MOSIII-H    | SOP Advance | 30                      | 27                    | 0.067                                      | –     |
| TPCA8006-H  | $\pi$ -MOSVII | SOP Advance | 100                     | 18                    | 0.58                                       | 35    |
| TPCA8008-H  | $\pi$ -MOSV   | SOP Advance | 250                     | 4                     | 0.35                                       | 25,35 |
| TPCA8009-H  | $\pi$ -MOSV   | SOP Advance | 150                     | 7                     | 0.45                                       | 25,35 |
| TPCA8010-H  | $\pi$ -MOSV   | SOP Advance | 200                     | 5.5                   | 0.0035                                     | 25,35 |
| TPCA8011-H  | U-MOSIII-H    | SOP Advance | 20                      | 40                    | 0.0049                                     | 24,35 |
| TPCA8012-H  | U-MOSV-H      | SOP Advance | 30                      | 35                    | 0.0049                                     | 24,35 |
| TPCA8014-H  | U-MOSIII-H    | SOP Advance | 40                      | 30                    | 0.0054                                     | 24,35 |
| TPCA8015-H  | U-MOSIII-H    | SOP Advance | 40                      | 35                    | 0.021                                      | 24,35 |
| TPCA8016-H  | U-MOSIII-H    | SOP Advance | 60                      | 25                    | 0.0062                                     | 25,35 |
| TPCA8018-H  | U-MOSV-H      | SOP Advance | 30                      | 27                    | 0.0031                                     | 24,35 |
| TPCA8019-H  | U-MOSV-H      | SOP Advance | 30                      | 40                    | 0.027                                      | 24,35 |
| TPCA8020-H  | U-MOSIII-H    | SOP Advance | 40                      | 7.5                   | 0.027                                      | 24,35 |
| TPCA8022-H  | U-MOSIII-H    | SOP Advance | 100                     | 22                    | 0.026                                      | 25,35 |
| TPCA8023-H  | U-MOSV-H      | SOP Advance | 30                      | 21                    | 0.0129                                     | 24    |
| TPCA8024    | U-MOSIV       | SOP Advance | 30                      | 35                    | 0.0043                                     | 27,35 |
| TPCA8025    | U-MOSIV       | SOP Advance | 30                      | 40                    | 0.0036                                     | 27,35 |
| TPCA8026    | U-MOSIV       | SOP Advance | 30                      | 45                    | 0.0022                                     | 27,35 |
| TPCA8027-H  | U-MOSIII      | SOP Advance | 40                      | 30                    | 0.01                                       | 24,35 |
| TPCA8028-H  | U-MOSVI-H     | SOP Advance | 30                      | 50                    | 0.0028                                     | 24,35 |
| TPCA8030-H  | U-MOSV-H      | SOP Advance | 30                      | 24                    | 0.011                                      | 24,35 |
| TPCA8031-H  | U-MOSV-H      | SOP Advance | 30                      | 24                    | 0.011                                      | 24,35 |
| TPCA8036-H  | U-MOSVI-H     | SOP Advance | 30                      | 38                    | 0.0042                                     | 24,35 |
| TPCA8039-H  | U-MOSVI-H     | SOP Advance | 30                      | 34                    | 0.0057                                     | 24,35 |
| TPCA8040-H  | U-MOSVI-H     | SOP Advance | 30                      | 23                    | 0.0094                                     | 24,35 |
| TPCA8045-H  | U-MOSVI-H     | SOP Advance | 40                      | 46                    | 0.0036                                     | 24,35 |
| TPCA8046-H  | U-MOSVI-H     | SOP Advance | 40                      | 38                    | 0.0054                                     | 24,35 |
| TPCA8047-H  | U-MOSVI-H     | SOP Advance | 40                      | 32                    | 0.0073                                     | 24,35 |
| TPCA8048-H  | U-MOSVI-H     | SOP Advance | 60                      | 35                    | 0.0066                                     | 25,35 |
| TPCA8049-H  | U-MOSVI-H     | SOP Advance | 60                      | 28                    | 0.0104                                     | 25,35 |
| TPCA8050-H  | U-MOSVI-H     | SOP Advance | 60                      | 24                    | 0.0142                                     | 25,35 |
| TPCA8051-H  | U-MOSVI-H     | SOP Advance | 80                      | 28                    | 0.0094                                     | 25,35 |
| TPCA8052-H  | U-MOSVI-H     | SOP Advance | 40                      | 20                    | 0.0113                                     | 24,35 |
| TPCA8053-H  | U-MOSVI-H     | SOP Advance | 60                      | 15                    | 0.0223                                     | 25,35 |
| TPCA8060-H  | U-MOSVI-H     | SOP Advance | 30                      | 45                    | 0.0034                                     | 24,35 |
| TPCA8101    | U-MOSIII      | SOP Advance | –30                     | –40                   | 0.007                                      | –     |
| TPCA8102    | U-MOSIII      | SOP Advance | –30                     | –40                   | 0.006                                      | –     |
| TPCA8103    | U-MOSIV       | SOP Advance | –30                     | –40                   | 0.0042                                     | 27,35 |
| TPCA8104    | U-MOSIII      | SOP Advance | –60                     | –40                   | 0.016                                      | 35,38 |
| TPCA8105    | U-MOSIII      | SOP Advance | –12                     | –6                    | 0.0033                                     | 27,35 |
| TPCA8106    | U-MOSV        | SOP Advance | –30                     | –40                   | 0.0037                                     | 27,35 |
| TPCA8107-H  | U-MOSIII-H    | SOP Advance | –40                     | –7.5                  | 0.03                                       | 25,35 |
| TPCA8108    | U-MOSIII      | SOP Advance | –40                     | –40                   | 0.0095                                     | 35    |
| TPCA8A01-H  | U-MOSIII-H    | SOP Advance | 30                      | 36                    | 0.0056                                     | –     |
| TPCA8A02-H  | U-MOSV-H      | SOP Advance | 30                      | 34                    | 0.0053                                     | 25,35 |
| TPCA8A04-H  | U-MOSV-H      | SOP Advance | 30                      | 44                    | 0.0032                                     | 25,35 |
| TPCA8A05-H  | U-MOSV-H      | SOP Advance | 30                      | 10                    | 0.0129                                     | 25,35 |
| TPCA8A08-H  | U-MOSV-H      | SOP Advance | 30                      | 38                    | 0.0042                                     | 25,35 |

| Part Number | Series           | Package       | Main Characteristics    |                       |  | Page  |
|-------------|------------------|---------------|-------------------------|-----------------------|--|-------|
|             |                  |               | V <sub>bss</sub><br>(V) | I <sub>D</sub><br>(A) | R <sub>DS(ON)</sub><br>Max<br>( $\Omega$ ) |       |
| TPCC8001-H  | U-MOSV-H         | TSOP Advance  | 30                      | 22                    | 0.0083                                     | 24,33 |
| TPCC8002-H  | U-MOSV-H         | TSOP Advance  | 30                      | 22                    | 0.0083                                     | 24,33 |
| TPCC8003-H  | U-MOSIV-H        | TSOP Advance  | 30                      | 13                    | 0.0169                                     | 24,33 |
| TPCC8005-H  | U-MOSV-H         | TSOP Advance  | 30                      | 26                    | 0.0064                                     | 24,33 |
| TPCC8006-H  | U-MOSIV-H        | TSOP Advance  | 30                      | 22                    | 0.008                                      | 24,33 |
| TPCC8007    | U-MOSIV          | TSOP Advance  | 20                      | 27                    | (0.0046)                                   | 27,33 |
| TPCC8008    | U-MOSIV          | TSOP Advance  | 30                      | 25                    | 0.0068                                     | 27,33 |
| TPCC8102    | U-MOSV           | TSOP Advance  | –30                     | –15                   | 0.0189                                     | 27,33 |
| TPCC8103    | U-MOSV           | TSOP Advance  | –30                     | –18                   | 0.012                                      | 27,33 |
| TPCC8A01-H  | U-MOSV-H         | TSOP Advance  | 30                      | 21                    | 0.0099                                     | 25,33 |
| TPCF8002    | U-MOSIV          | VS-8          | 30                      | 7                     | 0.023                                      | 31    |
| TPCF8101    | U-MOSIII         | VS-8          | –12                     | –6                    | 0.028                                      | 31    |
| TPCF8102    | U-MOSIII         | VS-8          | –20                     | –6                    | 0.03                                       | 31    |
| TPCF8103    | U-MOSIII         | VS-8          | –20                     | –2.7                  | 0.11                                       | 31    |
| TPCF8104    | U-MOSIII         | VS-8          | –30                     | –6                    | 0.028                                      | 31    |
| TPCF8201    | U-MOSIII         | VS-8          | 20                      | 3                     | 0.049                                      | 31    |
| TPCF8301    | U-MOSIII         | VS-8          | –20                     | –2.7                  | 0.11                                       | 31    |
| TPCF8302    | U-MOSIII         | VS-8          | –20                     | –3                    | 0.059                                      | 31    |
| TPCF8303    | U-MOSIII         | VS-8          | –20                     | –3                    | 0.058                                      | 31    |
| TPCF8304    | U-MOSIV          | VS-8          | –30                     | –3.2                  | 0.072                                      | 31    |
| TPCF8402    | U-MOSIII         | VS-8          | –30/30                  | –3.2/4                | 0.072/0.05                                 | 31    |
| TPCF8A01    | U-MOSIII         | VS-8          | 20                      | 3                     | 0.049                                      | 31    |
| TPCF8B01    | U-MOSIII         | VS-8          | –20                     | –2.7                  | 0.11                                       | 31    |
| TPCL4201    | U-MOSV           | Chip LGA      | 20                      | 6                     | 0.031                                      | 27,32 |
| TPCL4202    | U-MOSV           | Chip LGA      | 30                      | 6                     | 0.04                                       | 27,32 |
| TPCL4203    | U-MOSV           | Chip LGA      | 24                      | 6                     | 0.036                                      | 27,32 |
| TPCM8001-H  | U-MOSIII-H       | TSSOP Advance | 30                      | 20                    | 0.0095                                     | 33    |
| TPCM8002-H  | U-MOSV-H         | TSSOP Advance | 30                      | 30                    | 0.0062                                     | 24,33 |
| TPCM8003-H  | U-MOSV-H         | TSSOP Advance | 30                      | 21                    | 0.0129                                     | 24,33 |
| TPCM8004-H  | U-MOSV-H         | TSSOP Advance | 30                      | 24                    | 0.011                                      | 24,33 |
| TPCM8A05-H  | U-MOSV-H         | TSSOP Advance | 30                      | 20                    | 0.0129                                     | 25,33 |
| TPCP8001-H  | U-MOSIII-H       | PS-8          | 30                      | 7.2                   | 0.016                                      | 32    |
| TPCP8003-H  | U-MOSIII-H       | PS-8          | 100                     | 2.2                   | 0.19                                       | 25,32 |
| TPCP8004    | U-MOSIV          | PS-8          | 30                      | 8.3                   | 0.009                                      | 27,32 |
| TPCP8005-H  | U-MOSV-H         | PS-8          | 30                      | 11                    | 0.0133                                     | 24,32 |
| TPCP8006    | U-MOSIV          | PS-8          | 20                      | 9.1                   | 0.01                                       | 27,32 |
| TPCP8101    | U-MOSIII         | PS-8          | –20                     | –5.6                  | 0.03                                       | 32    |
| TPCP8102    | U-MOSIV          | PS-8          | –20                     | –7.6                  | 0.018                                      | 32    |
| TPCP8103-H  | U-MOSIII-H       | PS-8          | –40                     | –4.8                  | 0.04                                       | 25,32 |
| TPCP8201    | U-MOSIII         | PS-8          | 30                      | 4.2                   | 0.05                                       | 32    |
| TPCP8202    | U-MOSIV          | PS-8          | 30                      | 5.5                   | 0.023                                      | 27,32 |
| TPCP8203    | U-MOSIII         | PS-8          | 40                      | 4.7                   | 0.04                                       | 32    |
| TPCP8301    | U-MOSIV          | PS-8          | –20                     | –5                    | 0.031                                      | 32    |
| TPCP8302    | U-MOSIV          | PS-8          | –20                     | –5                    | 0.033                                      | 32    |
| TPCP8303    | U-MOSV           | PS-8          | –20                     | –3.8                  | 0.04                                       | 32    |
| TPCP8401    | U-MOSIII         | PS-8          | –12/20                  | –5.5/0.1              | 0.038/3                                    | 32    |
| TPCP8402    | U-MOSIII         | PS-8          | –30/30                  | –3.4/4.2              | 0.048/0.072                                | 32    |
| TPCP8403    | U-MOSIV/U-MOSIII | PS-8          | –40/40                  | –3.4/4.7              | 0.170/0.040                                | 32    |
| TPCP8404    | U-MOSV/U-MOSIV   | PS-8          | –30/30                  | –4/4                  | 0.05/0.05                                  | 32    |
| TPCP8A05-H  | U-MOSV-H         | PS-8          | 30                      | 8                     | 0.0175                                     | 32    |
| TPCP8AA1    | U-MOSII          | PS-8          | 20                      | 1.6                   | 0.105                                      | 32    |
| TPCP8BA1    | U-MOSII          | PS-8          | –20                     | –1.3                  | 0.18                                       | 32    |
| TPCP8J01    | U-MOSIV          | PS-8          | –32/50                  | –6/0.1                | 0.035                                      | 32    |
| TPCT4203    | U-MOSIV          | STP2          | 20                      | 6                     | 0.031                                      | 27,32 |
| TPCT4204    | U-MOSIV          | STP2          | 30                      | 6                     | 0.038                                      | 27,32 |

## 8-1 End-of-Life Products

The part numbers in the left-hand column below are end-of-life or obsolete products. When ordering, please choose from the replacement products in the right-hand column.

| End-of-Life Products |                            |                    |                            | Replacement Products |              |                            |                    |                            |            |
|----------------------|----------------------------|--------------------|----------------------------|----------------------|--------------|----------------------------|--------------------|----------------------------|------------|
| Part Number          | Electrical Characteristics |                    |                            | Package              | Part Number  | Electrical Characteristics |                    |                            | Package    |
|                      | V <sub>DSS</sub> (V)       | I <sub>D</sub> (A) | R <sub>DS(ON)</sub> Max(Ω) |                      |              | V <sub>DSS</sub> (V)       | I <sub>D</sub> (A) | R <sub>DS(ON)</sub> Max(Ω) |            |
| 2SJ148               | -60                        | -0.2               | 2                          | TO-92                | 2SJ168       | -60                        | -0.2               | 2                          | S-MINI     |
| 2SJ167               | -60                        | -0.2               | 2                          | N-MINI               | 2SJ168       | -60                        | -0.2               | 2                          | S-MINI     |
| 2SJ200               | -16                        | -2                 | 0.71                       | PW-Mini              | TPC6105      | -20                        | -2.7               | 0.11                       | VS-6       |
| 2SJ342               | -50                        | -0.05              | 50                         | N-MINI               | 2SJ343       | -50                        | -0.05              | 50                         | S-MINI     |
| 2SJ345               | -20                        | -0.05              | 40                         | S-MINI               | SSM3J16FU    | -20                        | -0.1               | 45                         | USM        |
| 2SJ346               | -20                        | -0.05              | 40                         | USM                  | SSM3J16FU    | -20                        | -0.1               | 45                         | USM        |
| 2SJ347               | -20                        | -0.05              | 40                         | SSM                  | SSM3J16FS    | -20                        | -0.1               | 45                         | SSM        |
| 2SJ511               | -30                        | -2                 | 0.76                       | PW-Mini              | TPC6108      | -30                        | -4.5               | 0.006                      | VS-6       |
| 2SJ525               | -30                        | -5                 | 0.12                       | TPS                  | TPCF8104     | -30                        | -6                 | 0.028                      | VS-8       |
| 2SK1061              | 60                         | 0.2                | 1                          | N-MINI               | SSM3K7002BF  | 60                         | 0.2                | 2.1                        | S-MINI     |
| 2SK1120              | 1000                       | 8                  | 1.8                        | TO-3P (N)            | 2SK2613      | 1000                       | 8                  | 1.7                        | TO-3P (N)  |
| 2SK1825              | 50                         | 0.05               | 50                         | N-MINI               | SSM3K7002BF  | 60                         | 0.2                | 2.1                        | S-MINI     |
| 2SK1826              | 50                         | 0.05               | 50                         | S-MINI               | SSM3K7002BF  | 60                         | 0.2                | 2.1                        | S-MINI     |
| 2SK1827              | 50                         | 0.05               | 50                         | USM                  | SSM3K7002BFU | 60                         | 0.2                | 2.1                        | USM        |
| 2SK1828              | 20                         | 0.05               | 40                         | S-MINI               | SSM3K15F     | 30                         | 0.1                | 7                          | S-MINI     |
| 2SK1829              | 20                         | 0.05               | 40                         | USM                  | SSM3K15FU    | 30                         | 0.1                | 7                          | USM        |
| 2SK1830              | 20                         | 0.05               | 40                         | SSM                  | SSM3K15FS    | 30                         | 0.1                | 7                          | SSM        |
| 2SK2033              | 20                         | 0.1                | 12                         | S-MINI               | SSM3K15F     | 30                         | 0.1                | 7                          | S-MINI     |
| 2SK2034              | 20                         | 0.1                | 12                         | USM                  | SSM3K15FU    | 30                         | 0.1                | 7                          | USM        |
| 2SK2035              | 20                         | 0.1                | 12                         | SSM                  | SSM3K15FS    | 30                         | 0.1                | 7                          | SSM        |
| 2SK2036              | 20                         | 0.1                | 6                          | S-MINI               | SSM3K15F     | 30                         | 0.1                | 7                          | S-MINI     |
| 2SK2037              | 20                         | 0.1                | 6                          | USM                  | SSM3K15FU    | 30                         | 0.1                | 7                          | USM        |
| 2SK2312              | 60                         | 45                 | 0.017                      | TO-220NIS            | 2SK3844      | 60                         | 45                 | 0.0058                     | TO-220NIS  |
| 2SK2466              | 100                        | 30                 | 0.046                      | TO-220NIS            | TK40A10K3    | 100                        | 40                 | 0.015                      | TO-220SIS  |
| 2SK2543              | 500                        | 8                  | 0.85                       | TO-220NIS            | TK8A50D      | 500                        | 8                  | 0.85                       | TO-220SIS  |
| 2SK2544              | 600                        | 6                  | 1.25                       | TO-220AB             | 2SK3761      | 600                        | 6                  | 1.25                       | TO-220AB   |
| 2SK2545              | 600                        | 6                  | 1.25                       | TO-220NIS            | TK6A60D      | 600                        | 6                  | 1.25                       | TO-220SIS  |
| 2SK2549              | 16                         | 2                  | 0.29                       | PW-Mini              | TPC6004      | 20                         | 6                  | 0.024                      | VS-6       |
| 2SK2604              | 800                        | 5                  | 2.2                        | TO-3P (N)            | 2SK3633      | 800                        | 7                  | 1.7                        | TO-3P (N)  |
| 2SK2605              | 800                        | 5                  | 2.2                        | TO-220NIS            | 2SK4013      | 800                        | 6                  | 1.7                        | TO-220SIS  |
| 2SK2610              | 900                        | 5                  | 2.5                        | TO-3P (N)            | 2SK3700      | 900                        | 5                  | 2.5                        | TO-3P (N)  |
| 2SK2611              | 900                        | 9                  | 1.4                        | TO-3P (N)            | 2SK3878      | 900                        | 9                  | 1.3                        | TO-3P (N)  |
| 2SK2661              | 500                        | 5                  | 1.5                        | TO-220AB             | 2SK3758      | 500                        | 5                  | 1.5                        | TO-220AB   |
| 2SK2662              | 500                        | 5                  | 1.5                        | TO-220NIS            | TK5A50D      | 500                        | 5                  | 1.5                        | TO-220SIS  |
| 2SK2698              | 500                        | 15                 | 0.4                        | TO-3P (N)            | TK15J50D     | 500                        | 15                 | 0.4                        | TO-3P (N)  |
| 2SK2700              | 900                        | 3                  | 4.3                        | TO-220NIS            | 2SK3564      | 900                        | 3                  | 4.3                        | TO-220SIS  |
| 2SK2717              | 900                        | 5                  | 2.5                        | TO-220NIS            | 2SK3565      | 900                        | 5                  | 2.5                        | TO-220SIS  |
| 2SK2718              | 900                        | 2.5                | 6.4                        | TO-220NIS            | 2SK3566      | 900                        | 2.5                | 6.4                        | TO-220SIS  |
| 2SK2746              | 800                        | 7                  | 1.7                        | TO-3P (N)            | 2SK3633      | 800                        | 7                  | 1.7                        | TO-3P (N)  |
| 2SK2749              | 900                        | 7                  | 2                          | TO-3P (N)            | 2SK4115      | 900                        | 7                  | 2                          | TO-3P (N)  |
| 2SK2750              | 600                        | 3.5                | 2.2                        | TO-220NIS            | TK4A60DA     | 600                        | 3.5                | 2.2                        | TO-220SIS  |
| 2SK2823              | 20                         | 0.1                | 40                         | S-MINI               | SSM3K35FS    | 20                         | 0.18               | 20                         | SSM        |
| 2SK2824              | 20                         | 0.1                | 40                         | USM                  | SSM3K35FS    | 20                         | 0.18               | 20                         | SSM        |
| 2SK2825              | 20                         | 0.1                | 40                         | SSM                  | SSM3K35FS    | 20                         | 0.18               | 20                         | SSM        |
| 2SK2837              | 500                        | 20                 | 0.27                       | TO-3P (N)            | TK20J50D     | 500                        | 20                 | 0.27                       | TO-3P (N)  |
| 2SK2842              | 500                        | 12                 | 0.52                       | TO-220NIS            | TK12A50D     | 500                        | 12                 | 0.52                       | TO-220SIS  |
| 2SK2843              | 600                        | 10                 | 0.75                       | TO-220NIS            | TK10A60D     | 600                        | 10                 | 0.75                       | TO-220SIS  |
| 2SK2844              | 30                         | 35                 | 0.02                       | TO-220AB             | TK70D06J1    | 60                         | 70                 | 0.0064                     | TO-220 (W) |
| 2SK2915              | 600                        | 16                 | 0.4                        | TO-3P (N)            | 2SK3903      | 600                        | 14                 | 0.44                       | TO-3P (N)  |
| 2SK2996              | 600                        | 10                 | 1                          | TO-220NIS            | 2SK4112      | 600                        | 10                 | 1                          | TO-220HIS  |

| End-of-Life Products |                            |                    |                            |             | Replacement Products |                            |                    |                            |            |
|----------------------|----------------------------|--------------------|----------------------------|-------------|----------------------|----------------------------|--------------------|----------------------------|------------|
| Part Number          | Electrical Characteristics |                    |                            | Package     | Part Number          | Electrical Characteristics |                    |                            | Package    |
|                      | V <sub>DSS</sub> (V)       | I <sub>D</sub> (A) | R <sub>DS(ON)</sub> Max(Ω) |             |                      | V <sub>DSS</sub> (V)       | I <sub>D</sub> (A) | R <sub>DS(ON)</sub> Max(Ω) |            |
| 2SK2964              | 30                         | 2                  | 0.18                       | PW-Mini     | TPC6003              | 30                         | 6                  | 0.024                      | VS-6       |
| 2SK3067              | 600                        | 2                  | 5                          | TO-220NIS   | 2SK3767              | 600                        | 2                  | 4.5                        | TO-220SIS  |
| 2SK3084              | 100                        | 30                 | 0.046                      | TO-220FL/SM | -                    | -                          | -                  | -                          | -          |
| 2SK3089              | 30                         | 40                 | 0.03                       | TO-220FL/SM | 2SK3847              | 40                         | 32                 | 0.018                      | TO-220SM   |
| 2SK3090              | 30                         | 45                 | 0.02                       | TO-220FL/SM | 2SK3847              | 40                         | 32                 | 0.018                      | TO-220SM   |
| 2SK3125              | 30                         | 70                 | 0.007                      | TO-3PSM     | 2SK3843              | 40                         | 75                 | 0.0035                     | TFP        |
| 2SK3126              | 450                        | 10                 | 0.65                       | TO-220NIS   | 2SK3869              | 450                        | 10                 | 0.68                       | TO-220SIS  |
| 2SK3127              | 30                         | 45                 | 0.012                      | TO-220FL/SM | 2SK3847              | 40                         | 32                 | 0.018                      | TO-220SM   |
| 2SK3128              | 30                         | 60                 | 0.012                      | TO-3P (N)   | 2SK3843              | 40                         | 75                 | 0.0035                     | TFP        |
| 2SK3129              | 50                         | 60                 | 0.007                      | TO-3P (N)   | 2SK3845              | 60                         | 70                 | 0.0058                     | TO-3P (N)  |
| 2SK3130              | 600                        | 6                  | 1.55                       | TO-220NIS   | 2SK3947              | 600                        | 6                  | 1.4                        | TO-220SIS  |
| 2SK3236              | 60                         | 35                 | 0.02                       | TO-220NIS   | 2SK3662              | 60                         | 35                 | 0.0125                     | TO-220NIS  |
| 2SK3316              | 500                        | 5                  | 1.8                        | TO-220NIS   | 2SK3868              | 500                        | 5                  | 1.7                        | TO-220NIS  |
| 2SK3389              | 30                         | 75                 | 0.005                      | TFP         | 2SK3843              | 40                         | 75                 | 0.008                      | TFP        |
| 2SK3397              | 30                         | 75                 | 0.006                      | TFP         | 2SK3843              | 40                         | 75                 | 0.0035                     | TFP        |
| 2SK3407              | 450                        | 10                 | 0.65                       | TO-220NIS   | 2SK3869              | 450                        | 10                 | 0.68                       | TO-220SIS  |
| 2SK3439              | 30                         | 75                 | 0.005                      | TFP         | 2SK3843              | 40                         | 75                 | 0.0035                     | TFP        |
| 2SK3440              | 60                         | 50                 | 0.008                      | TFP         | 2SK3842              | 60                         | 75                 | 0.0058                     | TFP        |
| 2SK3441              | 60                         | 75                 | 0.0058                     | TFP         | 2SK4034              | 60                         | 75                 | 0.0058                     | TFP        |
| 2SK3442              | 100                        | 45                 | 0.02                       | TFP         | TK40D10J1            | 100                        | 40                 | 0.015                      | TO-220 (W) |
| 2SK3443              | 150                        | 30                 | 0.055                      | TFP         | TK50X15J1            | 150                        | 50                 | 0.03                       | TFP        |
| 2SK3499              | 400                        | 10                 | 0.55                       | TFP         | TK10X40D*            | 400                        | 10                 | 0.55                       | TFP        |
| 2SK3543              | 450                        | 2                  | 2.45                       | TO-220NIS   | 2SK3757              | 450                        | 2                  | 2.45                       | TO-220SIS  |
| 2SK982               | 60                         | 0.2                | 1                          | TO-92       | SSM3K7002BF          | 60                         | 0.2                | 2.1                        | S-MINI     |
| HN1J02FU             | -20                        | -0.05              | 40                         | US6         | SSM6P16FU            | -20                        | -0.1               | 45                         | US6        |
| HN1K02FU             | 20                         | 0.05               | 40                         | US6         | SSM6N16FU            | 20                         | 0.1                | 15                         | US6        |
| HN1K03FU             | 20                         | 0.1                | 12                         | US6         | SSM6N16FU            | 20                         | 0.1                | 15                         | US6        |
| HN1K04FU             | 50                         | 0.05               | 50                         | US6         | SSM6K7002BFU         | 60                         | 0.2                | 2.1                        | US6        |
| HN1K05FU             | 20                         | 0.1                | 40                         | US6         | SSM6N35FU            | 20                         | 0.18               | 20                         | US6        |
| HN1K06FU             | 20                         | 0.1                | 6                          | US6         | SSM6N15FU            | 30                         | 0.1                | 7                          | US6        |
| HN1L02FU             | 20                         | 0.05               | 40                         | US6         | SSM6L35FU            | 20                         | 0.18               | 20                         | US6        |
| HN1L03FU             | 50                         | 0.05               | 50                         | US6         | -                    | -                          | -                  | -                          | -          |
| HN4K03JU             | 20                         | 0.1                | 12                         | UFV         | SSM5N15FU            | 30                         | 0.1                | 7                          | USV        |
| SSM3J01F             | -30                        | -0.7               | 0.6                        | S-MINI      | SSM3J01T             | -30                        | -1.7               | 0.6                        | TSM        |
| SSM3J02F             | -30                        | -0.6               | 0.7                        | S-MINI      | SSM3J02T             | -30                        | -1.6               | 0.7                        | TSM        |
| SSM3J15TE            | -30                        | -0.1               | 32                         | TESM        | SSM3J15FV            | -30                        | -0.1               | 32                         | VESM       |
| SSM3J16TE            | -20                        | -0.1               | 45                         | TESM        | SSM3J16FV            | -20                        | -0.1               | 45                         | VESM       |
| SSM3K01F             | 30                         | 1.3                | 0.15                       | S-MINI      | SSM3K01T             | 30                         | 3.2                | 0.15                       | TSM        |
| SSM3K02F             | 30                         | 1                  | 0.25                       | S-MINI      | SSM3K02T             | 30                         | 2.5                | 0.25                       | TSM        |
| SSM3K03C             | 20                         | 0.1                | 12                         | SS-CSP      | SSM3K16CT            | 20                         | 0.1                | 15                         | CST3       |
| SSM3K03FE            | 20                         | 0.1                | 12                         | ESM         | SSM3K16FS            | 20                         | 0.1                | 15                         | SSM        |
| SSM3K03TE            | 20                         | 0.1                | 12                         | TESM        | SSM3K16FV            | 20                         | 0.1                | 15                         | VESM       |
| SSM3K04FE            | 20                         | 0.1                | 12                         | ESM         | SSM3K04FS            | 20                         | 0.1                | 12                         | SSM        |
| SSM3K126TU           | 30                         | 3.9                | 0.043                      | UFM         | SSM3K131TU           | 30                         | 6                  | 0.0415                     | UFM        |
| SSM3K15TE            | 30                         | 0.1                | 7                          | TESM        | SSM3K15FV            | 30                         | 0.1                | 7                          | VESM       |
| SSM3K16TE            | 20                         | 0.1                | 15                         | TESM        | SSM3K16FV            | 20                         | 0.1                | 15                         | VESM       |
| SSM3K302T            | 30                         | 3                  | 0.071                      | TSM         | SSM3K316T            | 30                         | 4                  | 0.065                      | TSM        |
| SSM3K311T            | 30                         | 4.6                | 0.043                      | TSM         | SSM3K315T            | 30                         | 6                  | 0.0415                     | TSM        |
| SSM6G06FE            | -20                        | -0.1               | 45                         | ES6         | -                    | -                          | -                  | -                          | -          |
| SSM6H06FE            | 20                         | 0.1                | 15                         | ES6         | -                    | -                          | -                  | -                          | -          |
| TPC6106              | -40                        | -3.9               | 0.08                       | VS-6        | -                    | -                          | -                  | -                          | -          |
| TPCT4201             | 20                         | 6                  | 0.031                      | STP         | TPCT4203             | 20                         | 6                  | 0.031                      | STP2       |
| TPCT4202             | 30                         | 6                  | 0.038                      | STP         | TPCT4204             | 30                         | 6                  | 0.038                      | STP2       |
| TPC6201              | 30                         | 2.5                | 0.095                      | VS-6        | TPCP8202             | 30                         | 5.5                | 0.023                      | PS-8       |
| TPC8301              | -30                        | -3.5               | 0.12                       | SOP-8       | TPCF8304             | -30                        | 3.2                | 0.105                      | SOP-8      |
| TPC8303              | -30                        | -4.5               | 0.035                      | SOP-8       | -                    | -                          | -                  | -                          | -          |

\*: Under development





■ UFM

Unit: mm

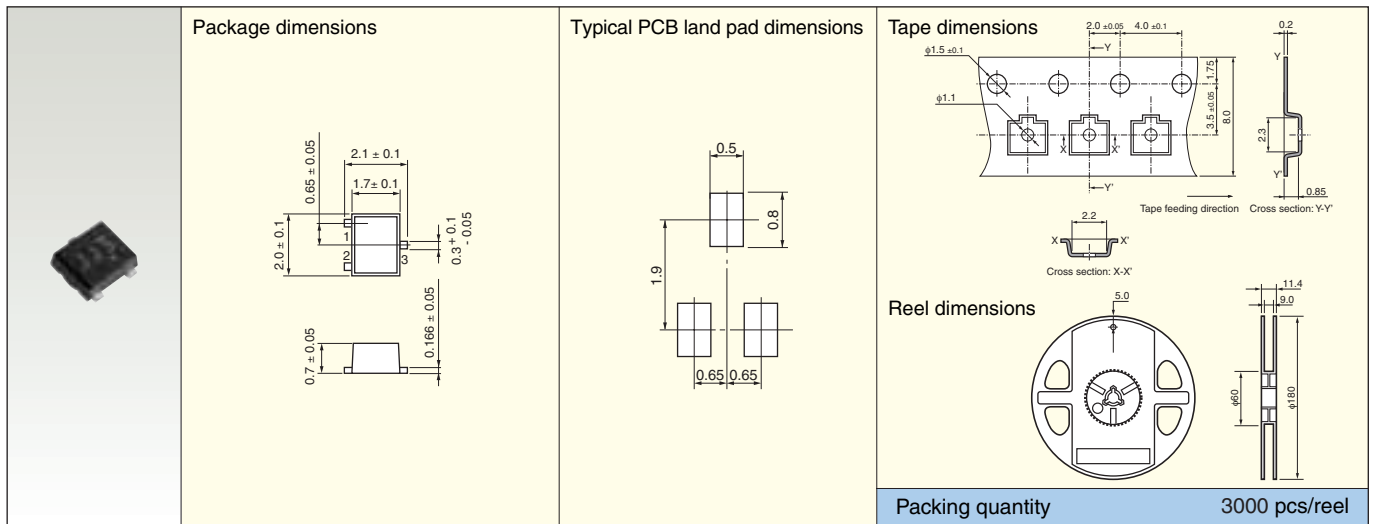

■ S-Mini (SOT-346)(SC-59)

Unit: mm

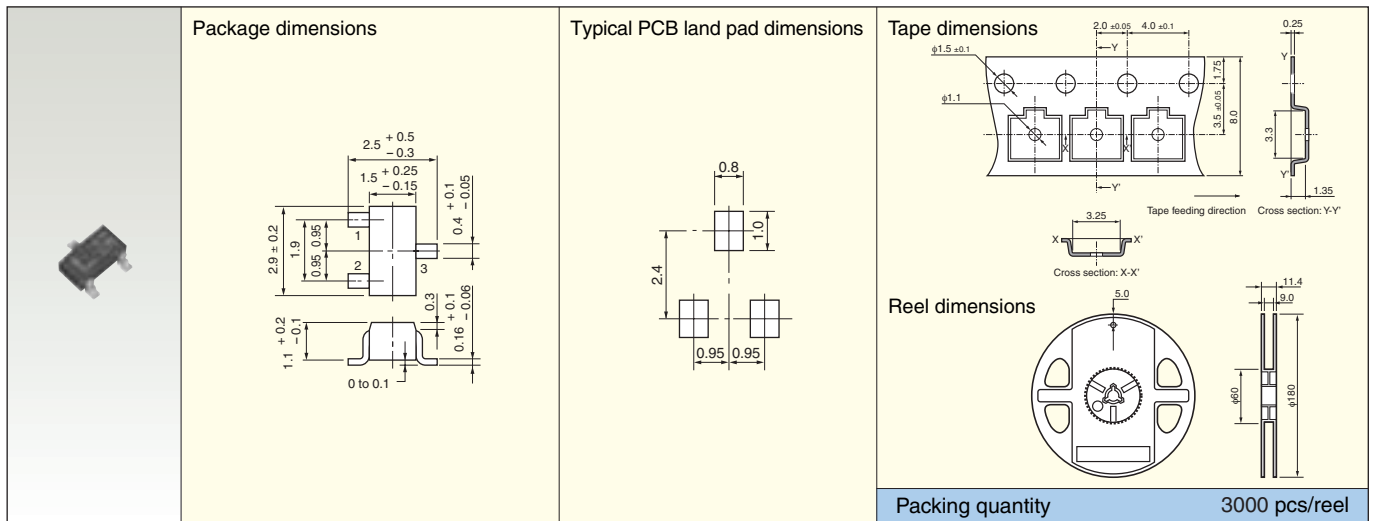

■ TSM

Unit: mm

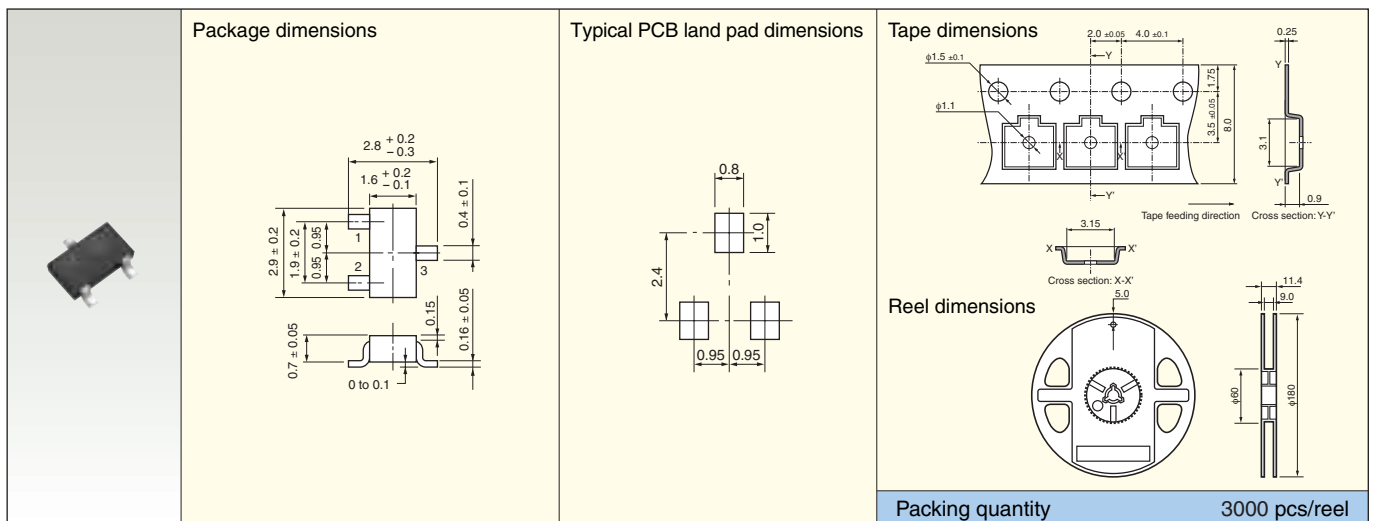

## ■ CST4

Unit: mm

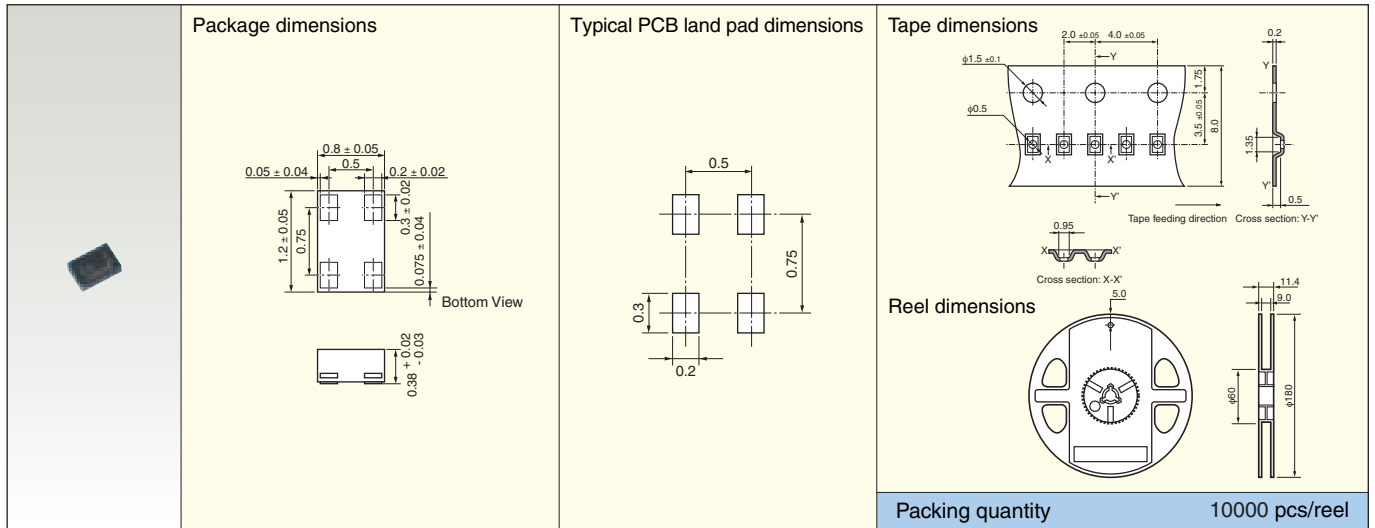

## ■ ESV (SOT-553)

Unit: mm

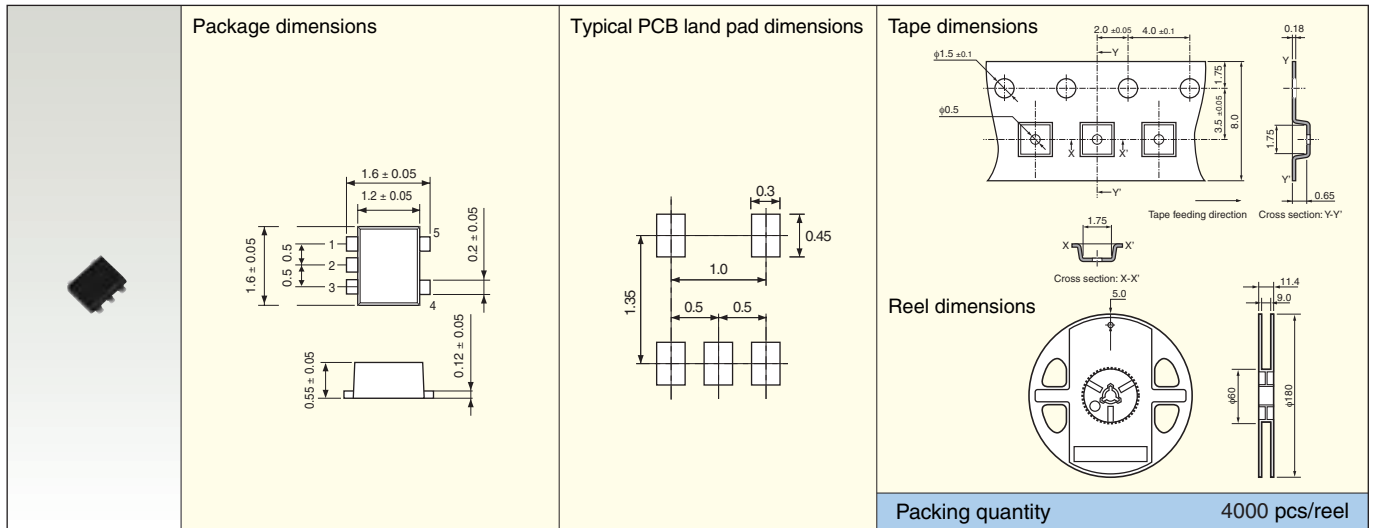

## ■ USV (SOT-353)(SC-88A)

Unit: mm

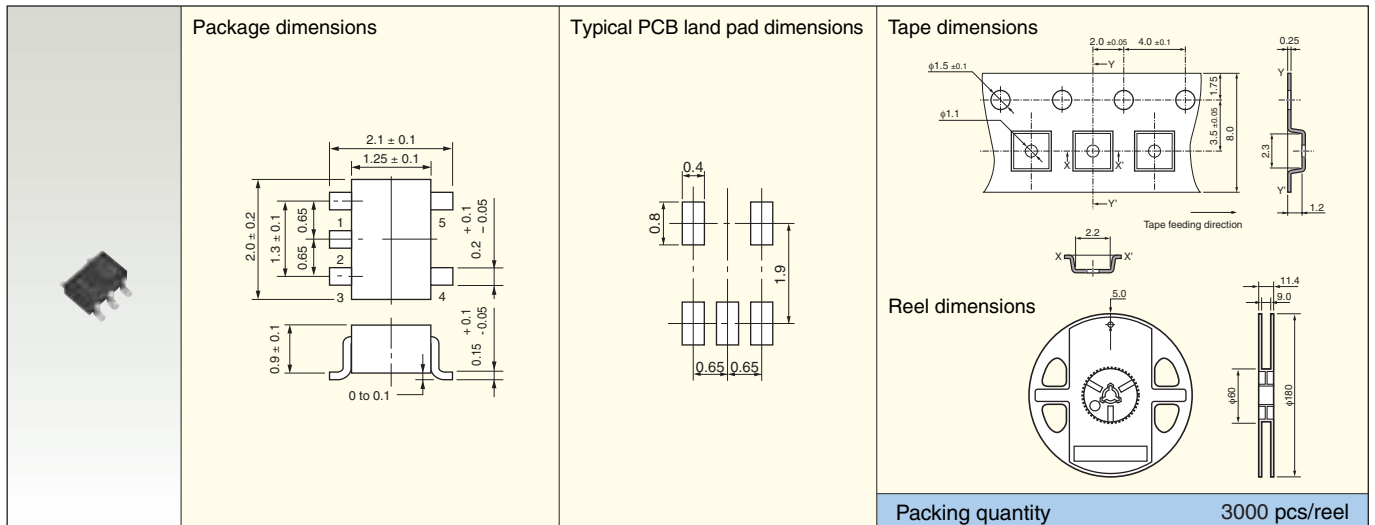

■ UFV

Unit: mm



■ SMV (SOT-25)(SC-74A)

Unit: mm



■ CST6D

Unit: mm

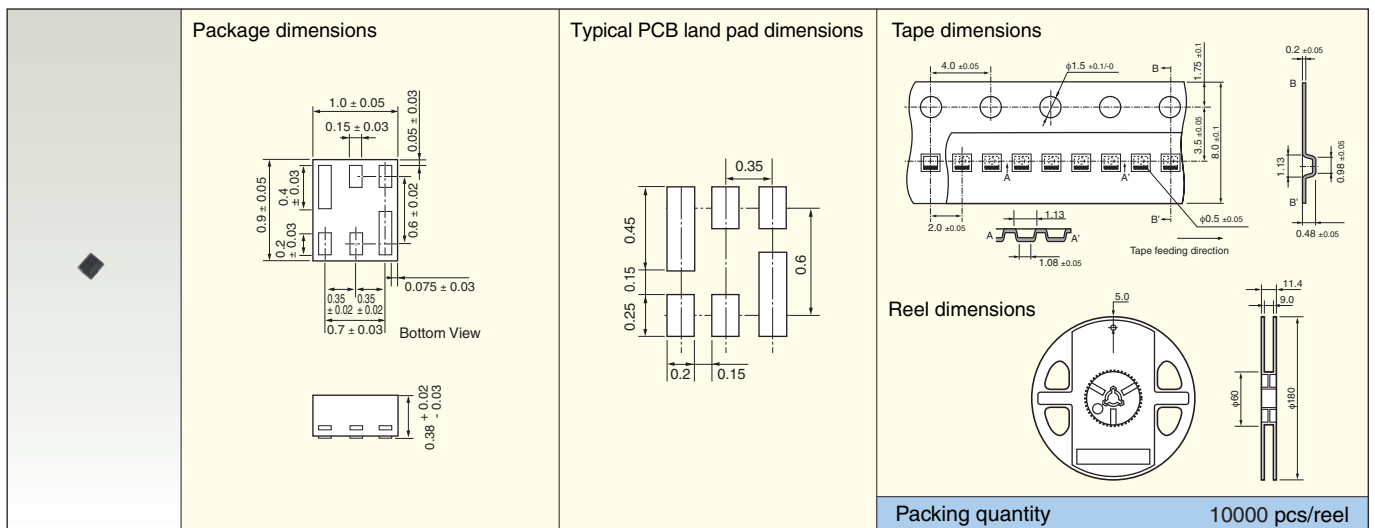

■ ES6 (SOT-563)

Unit: mm

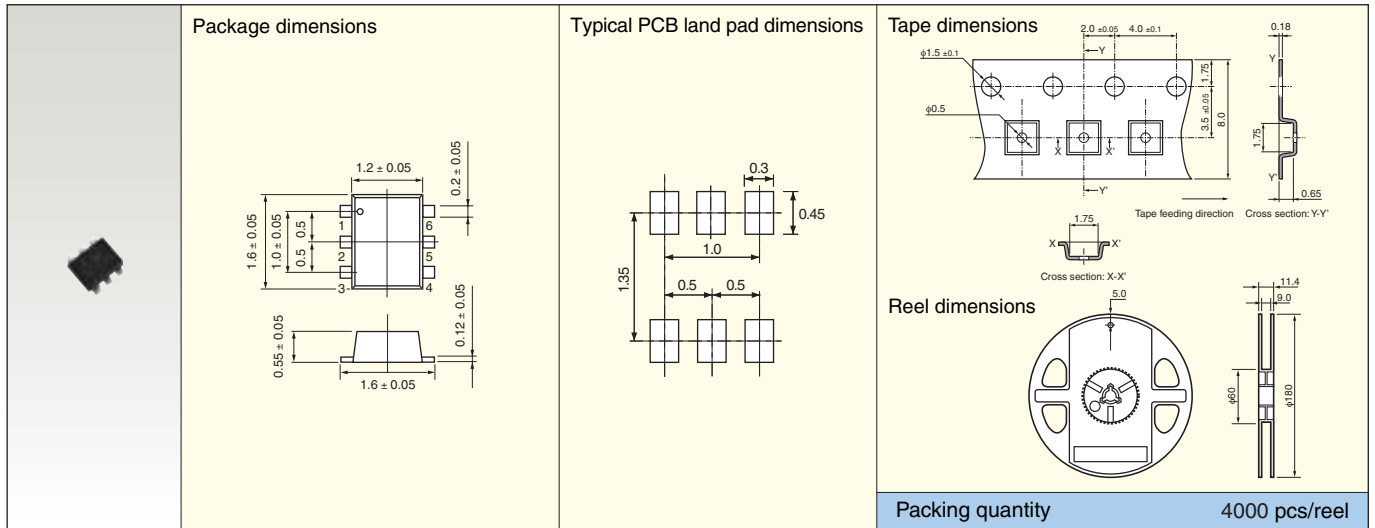

■ US6 (SOT-363)(SC-88)

Unit: mm

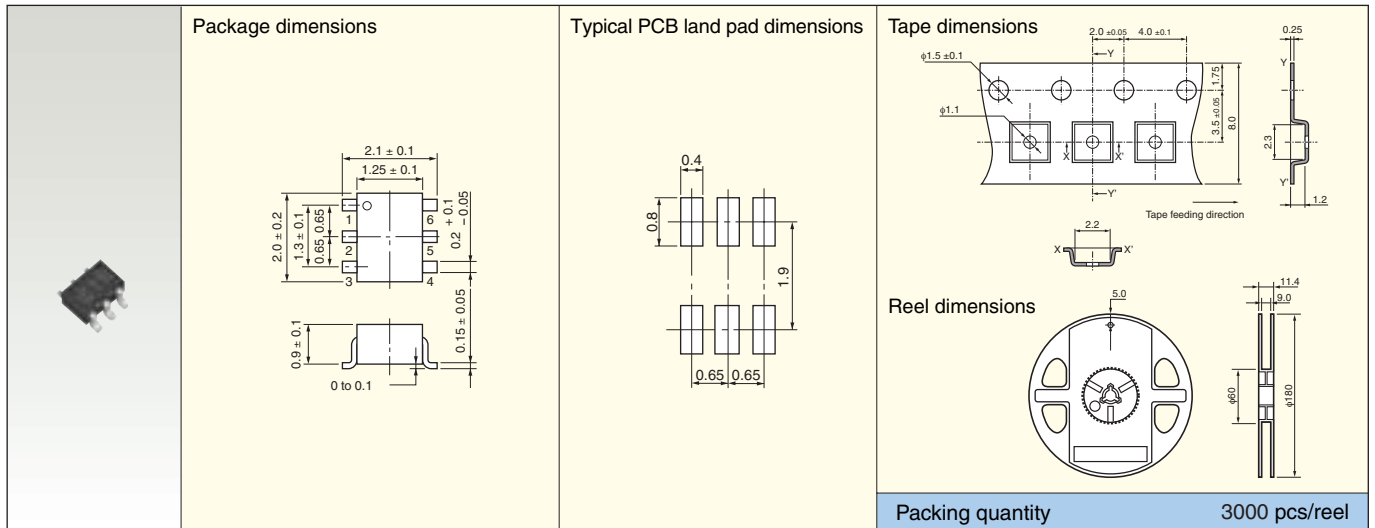

■ UF6

Unit: mm

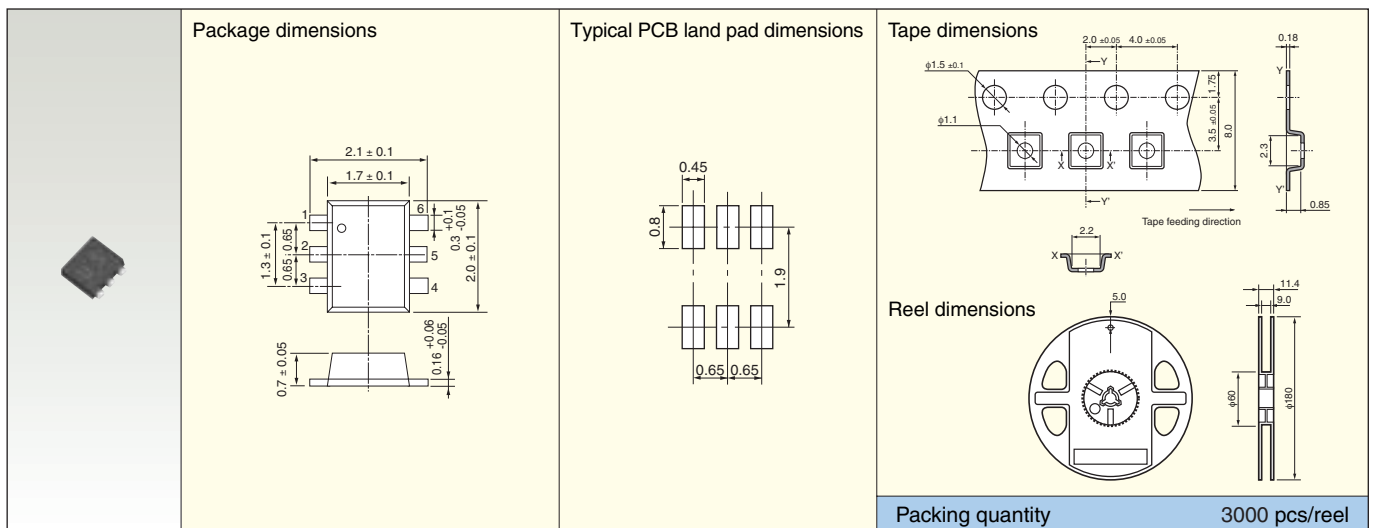

■ VS-6

Unit: mm



■ VS-8

Unit: mm



■ PS-8

Unit: mm

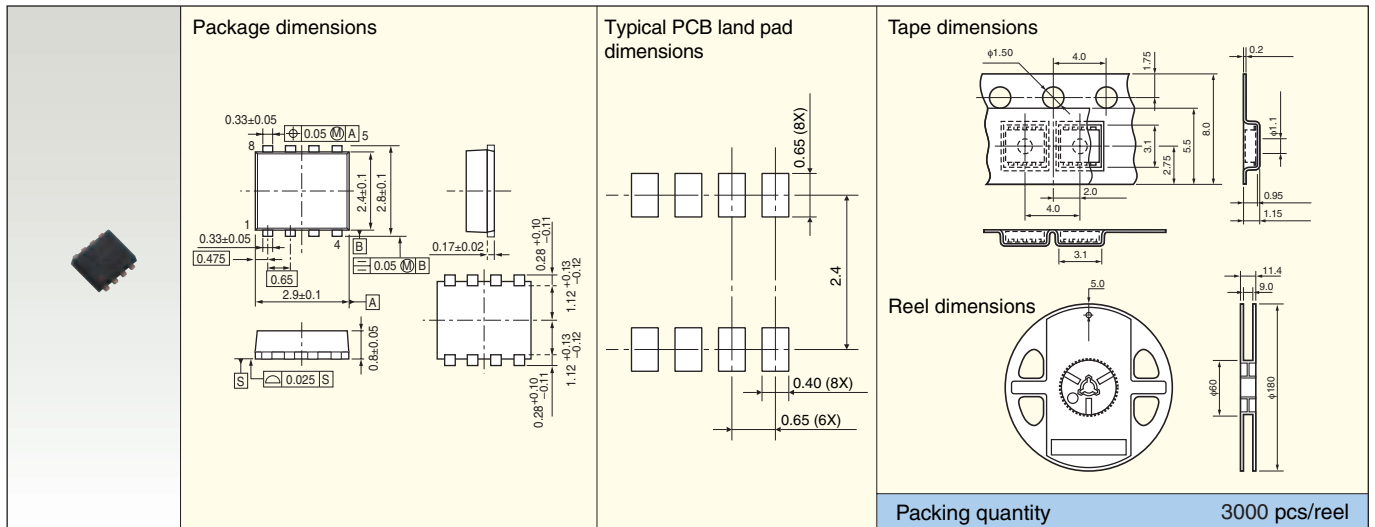



## ■ TSSOP Advance

Unit: mm



## ■ TSSOP-8

Unit: mm

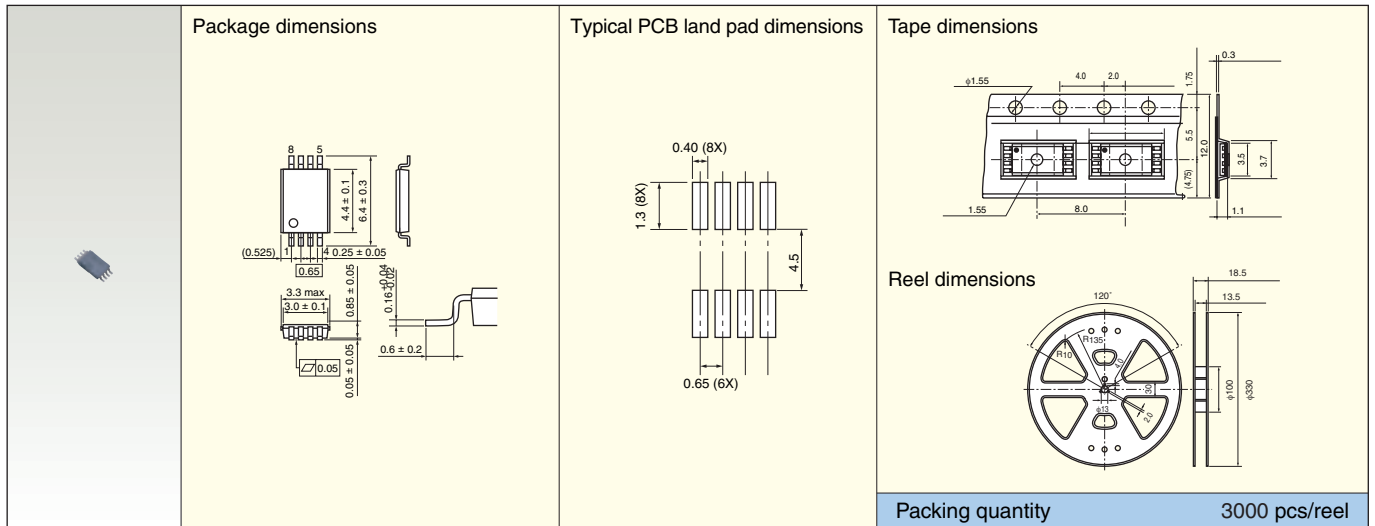

## ■ SOP-8

Unit: mm

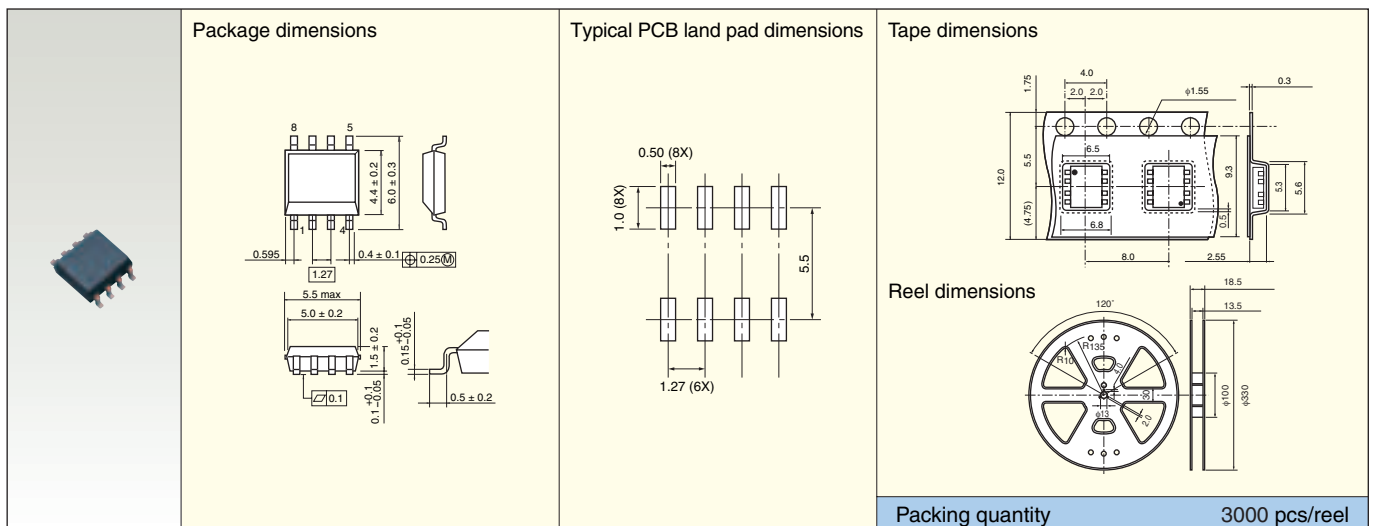

## ■ SOP Advance

Unit: mm



## ■ PW-Mini

Unit: mm



## ■ DP

Unit: mm



### ■ New PW-Mold

Unit: mm

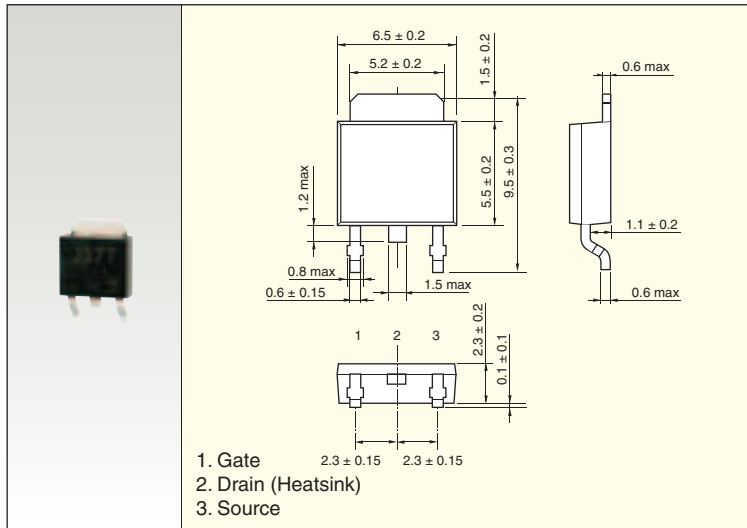

#### Tape dimensions

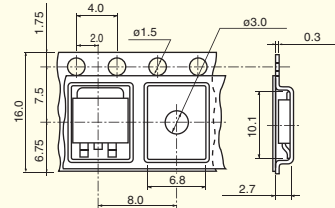

#### Reel dimensions

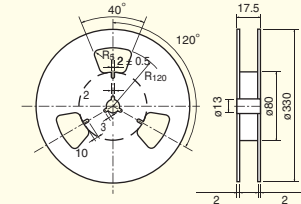

Packing quantity

2000 pcs/reel

### ■ DPAK

Unit: mm

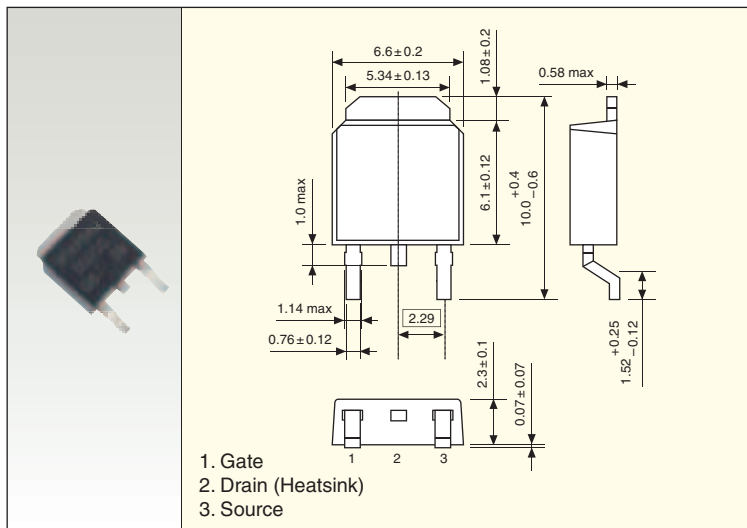

#### Tape dimensions

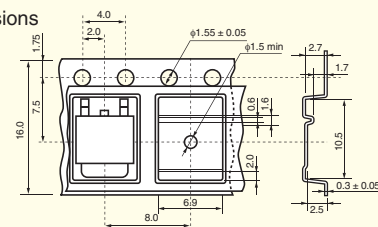

#### Reel dimensions

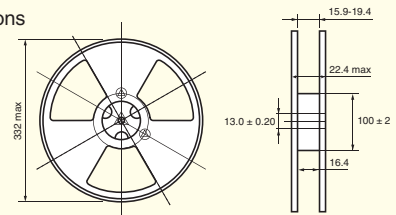

Packing quantity

2000 pcs/reel

### ■ TO-220SM

Unit: mm

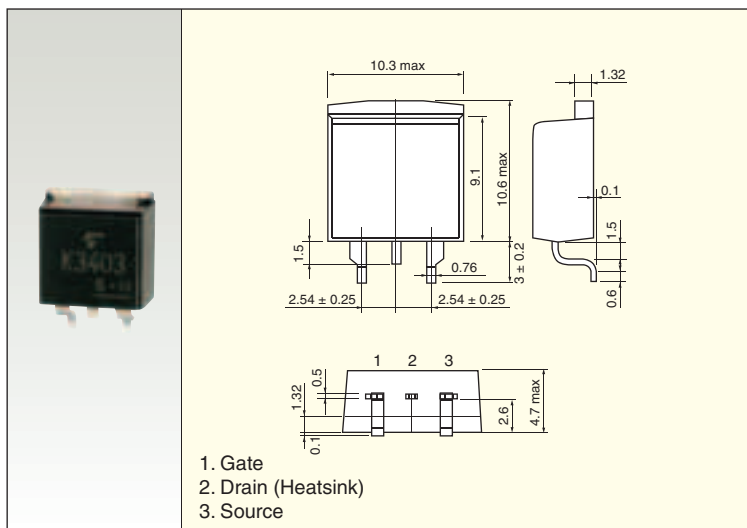

#### Tape dimensions

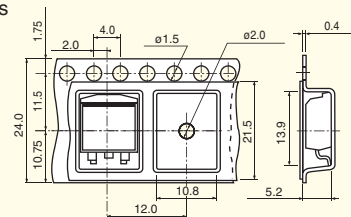

#### Reel dimensions

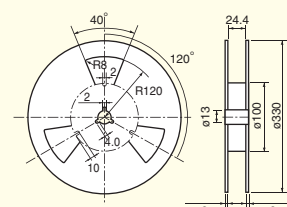

Packing quantity

1000 pcs/reel

## TO-220SM(W)

Unit: mm

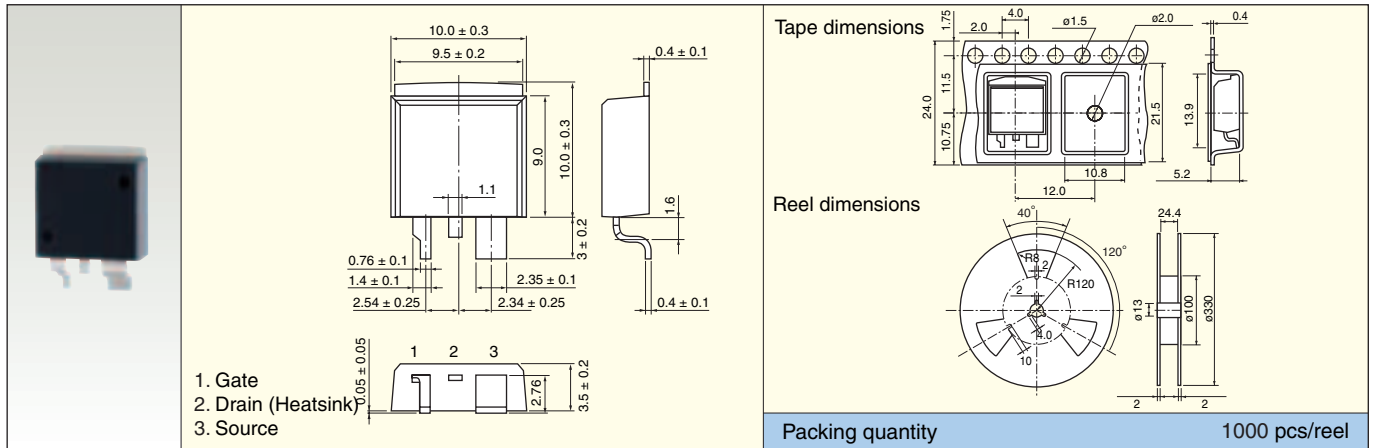

## TFP

Unit: mm

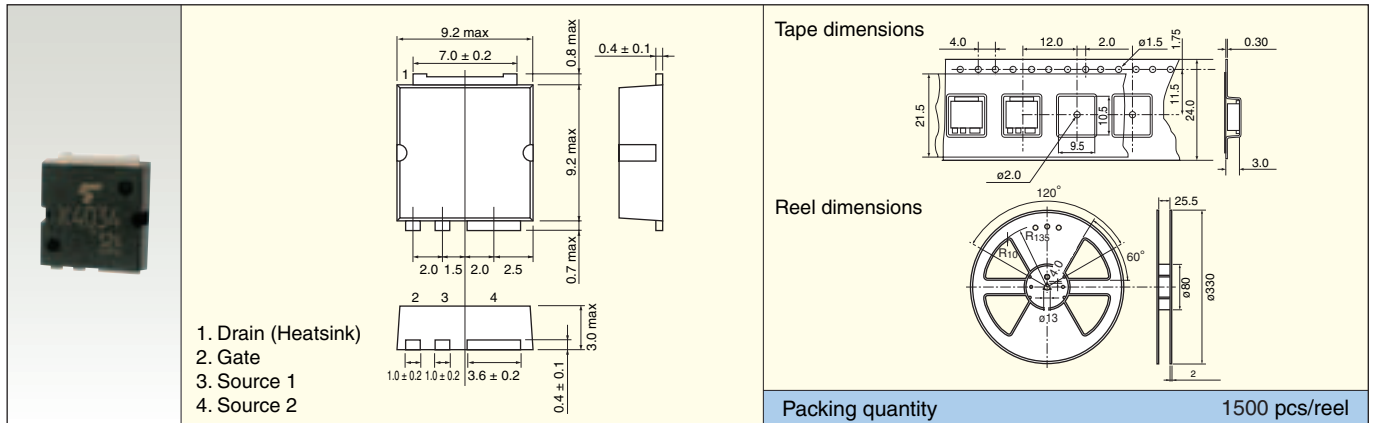

## 9-2 Through-Hole Packages

### LSTM

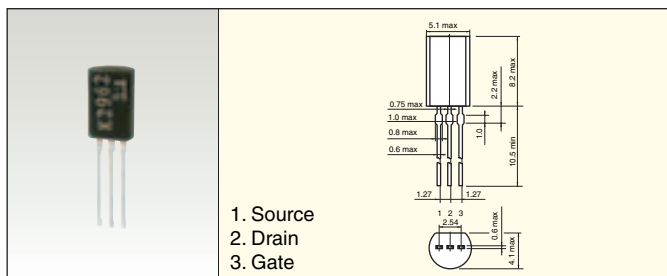

### PW-Mold (Straight)

Unit: mm

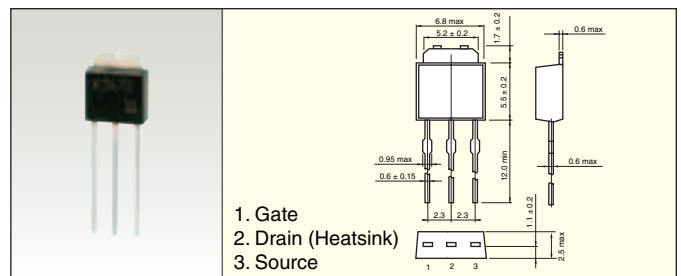

### New PW-Mold2

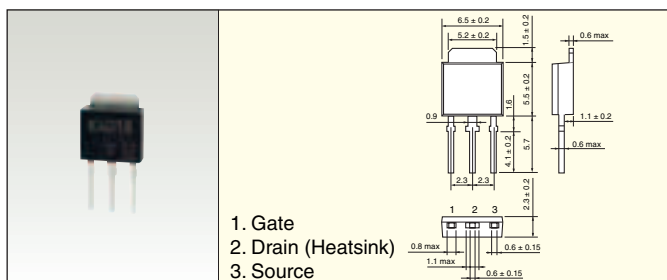

### DP (Straight)

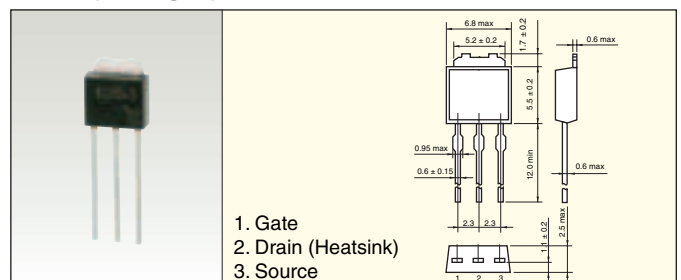

■ TPS

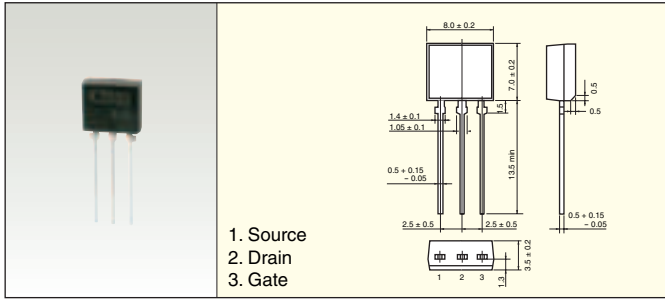

■ TO-220AB

Unit: mm

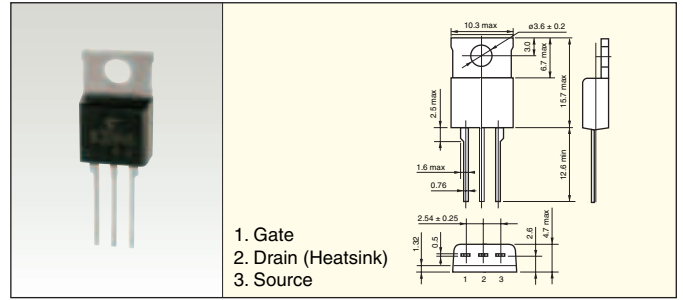

■ TO-220(W)

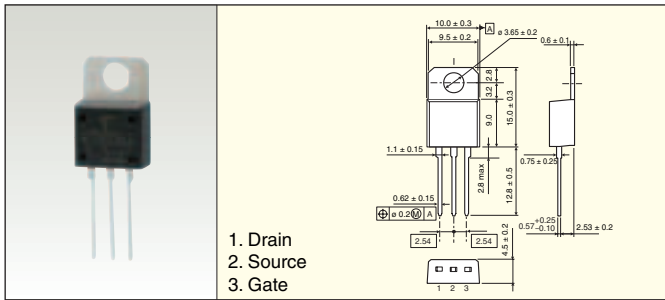

■ TO-220NIS

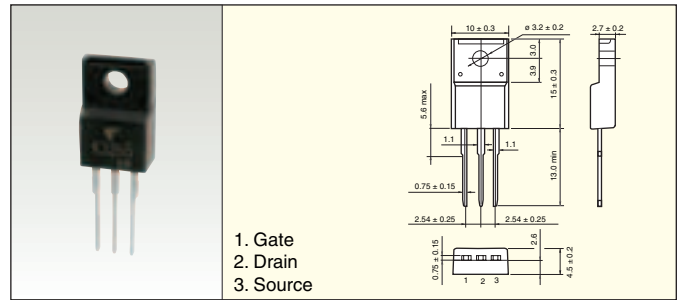

■ TO-220SIS

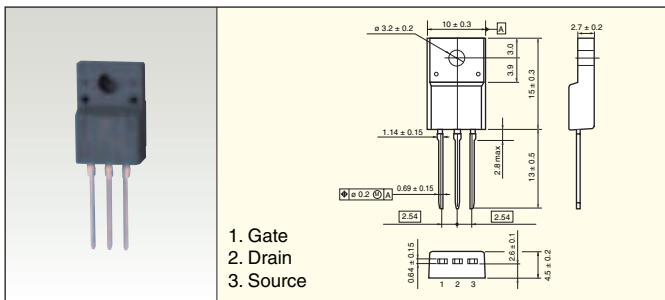

■ TO-220FL

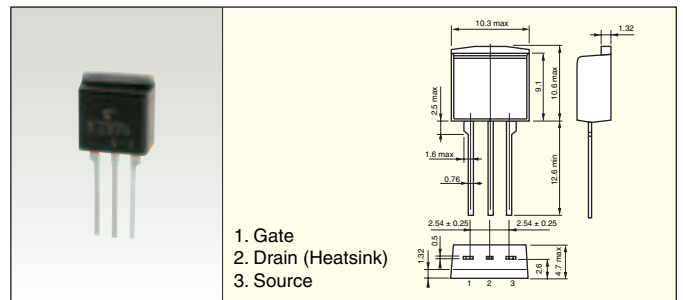

■ TO-3P(N)

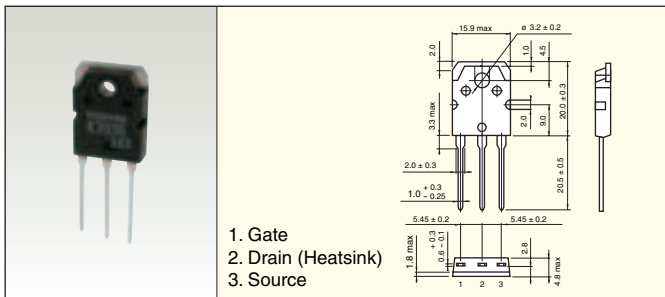

■ TO-3P(N)IS

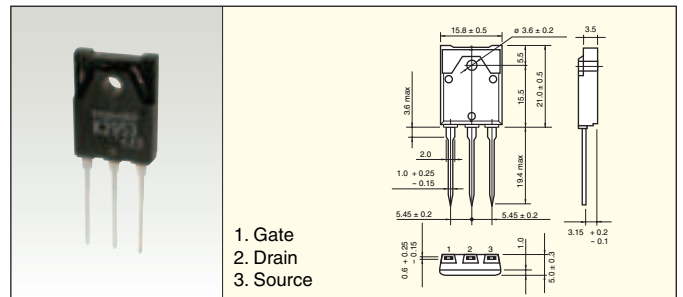

■ TO-3P(L)

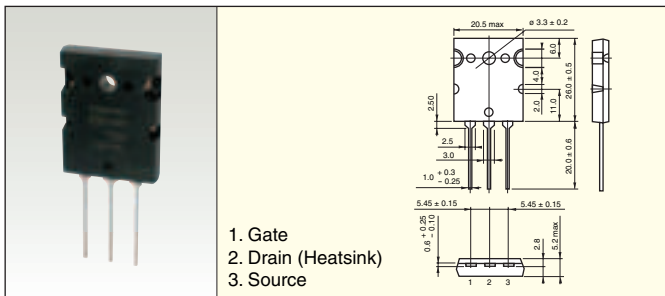

**Toshiba America****Electronic Components, Inc.**

- Headquarters-Irvine, CA  
Tel: (949)623-2900 Fax: (949)474-1330
- Buffalo Grove (Chicago)  
Tel: (847)484-2400 Fax: (847)541-7287
- Duluth, GA (Atlanta)  
Tel: (770)931-3363 Fax: (770)931-7602
- San Jose Engineering Center, CA  
Tel: (408)526-2400 Fax: (408)526-2410
- Wixom (Detroit)  
Tel: (248)347-2607 Fax: (248)347-2602

**Toshiba Electronics do Brasil Ltda.**

Tel: (011)2539-6681 Fax: (011)2539-6675

**Toshiba India Private Ltd.**

Tel: (011)2331-8422 Fax: (011)2371-4603

**Toshiba Electronics Europe GmbH**

- Düsseldorf Head Office  
Tel: (0211)5296-0 Fax: (0211)5296-400
- France Branch  
Tel: (1)48-12-48-12 Fax: (1)48-94-51-15
- Italy Branch  
Tel: (039)68701 Fax: (039)6870205
- Spain Branch  
Tel: (91)660-6798 Fax: (91)660-6799
- U.K. Branch  
Tel: (0870)060-2370 Fax: (01252)53-0250
- Sweden Branch  
Tel: (08)704-0900 Fax: (08)80-8459

**Toshiba Electronics Asia (Singapore) Pte. Ltd.**

Tel: (6278)5252 Fax: (6271)5155

**Toshiba Electronics Service (Thailand) Co., Ltd.**

Tel: (02)501-1635 Fax: (02)501-1638

**Toshiba Electronics Trading (Malaysia) Sdn. Bhd.**

- Kuala Lumpur Head Office  
Tel: (03)5631-6311 Fax: (03)5631-6307
- Penang Office  
Tel: (04)226-8523 Fax: (04)226-8515

**Toshiba Electronics Philippines, Inc.**

Tel: (02)750-5510 Fax: (02)750-5511

**Toshiba Electronics Asia, Ltd.**

- Hong Kong Head Office  
Tel: 2375-6111 Fax: 2375-0969
- Beijing Office  
Tel: (010)6590-8796 Fax: (010)6590-8791
- Chengdu Office  
Tel: (028)8675-1773 Fax: (028)8675-1065
- Qingdao Office  
Tel: (532)8579-3328 Fax: (532)8579-3329

**Toshiba Electronics Shenzhen Co., Ltd.**

Tel: (0755)2399-6897 Fax: (0755)2399-5573

**Toshiba Electronics (Shanghai) Co., Ltd.**

- Shanghai Head Office  
Tel: (021)6841-0666 Fax: (021)6841-5002
- Hangzhou Office  
Tel: (0571)8717-5004 Fax: (0571)8717-5013
- Nanjing Office  
Tel: (025)8689-0070 Fax: (025)8689-0125

**Toshiba Electronics (Dalian) Co., Ltd.**

Tel: (0411)8368-6882 Fax: (0411)8369-0822

**Tsurong Xiamen Xiangyu Trading Co., Ltd.**

Tel: (0592)226-1398 Fax: (0592)226-1399

**Toshiba Electronics Korea Corporation**

- Seoul Head Office  
Tel: (02)3484-4334 Fax: (02)3484-4302
- Daegu Office  
Tel: (053)428-7610 Fax: (053)428-7617

**Toshiba Electronics Taiwan Corporation**

- Taipei Head Office  
Tel: (02)2508-9988 Fax: (02)2508-9999
- Kaohsiung Office  
Tel: (07)237-0826 Fax: (07)236-0046

- ▶ Toshiba Corporation, and its subsidiaries and affiliates (collectively "TOSHIBA"), reserve the right to make changes to the information in this document, and related hardware, software and systems (collectively "Product") without notice.
- ▶ This document and any information herein may not be reproduced without prior written permission from TOSHIBA. Even with TOSHIBA's written permission, reproduction is permissible only if reproduction is without alteration/omission.
- ▶ Though TOSHIBA works continually to improve Product's quality and reliability, Product can malfunction or fail. Customers are responsible for complying with safety standards and for providing adequate designs and safeguards for their hardware, software and systems which minimize risk and avoid situations in which a malfunction or failure of Product could cause loss of human life, bodily injury or damage to property, including data loss or corruption. Before creating and producing designs and using, customers must also refer to and comply with (a) the latest versions of all relevant TOSHIBA information, including without limitation, this document, the specifications, the data sheets and application notes for Product and the precautions and conditions set forth in the "TOSHIBA Semiconductor Reliability Handbook" and (b) the instructions for the application that Product will be used with or for. Customers are solely responsible for all aspects of their own product design or applications, including but not limited to (a) determining the appropriateness of the use of this Product in such design or applications; (b) evaluating and determining the applicability of any information contained in this document, or in charts, diagrams, programs, algorithms, sample application circuits, or any other referenced documents; and (c) validating all operating parameters for such designs and applications. **TOSHIBA ASSUMES NO LIABILITY FOR CUSTOMERS' PRODUCT DESIGN OR APPLICATIONS.**
- ▶ Product is intended for use in general electronics applications (e.g., computers, personal equipment, office equipment, measuring equipment, industrial robots and home electronics appliances) or for specific applications as expressly stated in this document. Product is neither intended nor warranted for use in equipment or systems that require extraordinarily high levels of quality and/or reliability and/or a malfunction or failure of which may cause loss of human life, bodily injury, serious property damage or serious public impact ("Unintended Use"). Unintended Use includes, without limitation, equipment used in nuclear facilities, equipment used in the aerospace industry, medical equipment, equipment used for automobiles, trains, ships and other transportation, traffic signaling equipment, equipment used to control combustions or explosions, safety devices, elevators and escalators, devices related to electric power, and equipment used in finance-related fields. Do not use Product for Unintended Use unless specifically permitted in this document.
- ▶ Do not disassemble, analyze, reverse-engineer, alter, modify, translate or copy Product, whether in whole or in part.
- ▶ Product shall not be used for or incorporated into any products or systems whose manufacture, use, or sale is prohibited under any applicable laws or regulations.
- ▶ The information contained herein is presented only as guidance for Product use. No responsibility is assumed by TOSHIBA for any infringement of patents or any other intellectual property rights of third parties that may result from the use of Product. No license to any intellectual property right is granted by this document, whether express or implied, by estoppel or otherwise.
- ▶ **ABSENT A WRITTEN SIGNED AGREEMENT, EXCEPT AS PROVIDED IN THE RELEVANT TERMS AND CONDITIONS OF SALE FOR PRODUCT, AND TO THE MAXIMUM EXTENT ALLOWABLE BY LAW, TOSHIBA (1) ASSUMES NO LIABILITY WHATSOEVER, INCLUDING WITHOUT LIMITATION, INDIRECT, CONSEQUENTIAL, SPECIAL, OR INCIDENTAL DAMAGES OR LOSS, INCLUDING WITHOUT LIMITATION, LOSS OF PROFITS, LOSS OF OPPORTUNITIES, BUSINESS INTERRUPTION AND LOSS OF DATA, AND (2) DISCLAIMS ANY AND ALL EXPRESS OR IMPLIED WARRANTIES AND CONDITIONS RELATED TO SALE, USE OF PRODUCT, OR INFORMATION, INCLUDING WARRANTIES OR CONDITIONS OF MERCHANTABILITY, FITNESS FOR A PARTICULAR PURPOSE, ACCURACY OF INFORMATION, OR NONINFRINGEMENT.**
- ▶ Do not use or otherwise make available Product or related software or technology for any military purposes, including without limitation, for the design, development, use, stockpiling or manufacturing of nuclear, chemical, or biological weapons or missile technology products (mass destruction weapons). Product and related software and technology may be controlled under the Japanese Foreign Exchange and Foreign Trade Law and the U.S. Export Administration Regulations. Export and re-export of Product or related software or technology are strictly prohibited except in compliance with all applicable export laws and regulations.
- ▶ Please contact your TOSHIBA sales representative for details as to environmental matters such as the RoHS compatibility of Product. Please use Product in compliance with all applicable laws and regulations that regulate the inclusion or use of controlled substances, including without limitation, the EU RoHS Directive. TOSHIBA assumes no liability for damages or losses occurring as a result of noncompliance with applicable laws and regulations.

**TOSHIBA****TOSHIBA CORPORATION**  
Semiconductor CompanyWebsite: <http://www.semicon.toshiba.co.jp/eng>

©2009 TOSHIBA CORPORATION

Previous edition: BCE0082A  
2009-9(1k)SO-DQ

MOSFETS

## Looking for pricing, stock, or lifecycle information?

Click below to explore more details on WIN SOURCE:

- ⊖ [View TPCA8107-H on WIN SOURCE](#)
- ⊖ [Toshiba Semiconductor and Storage Information](#)

## Optimize Your Supply Chain with WIN SOURCE Solutions

- ✓ Global Sourcing Solution
- ✓ Obsolete Management
- ✓ Cost Control Management
- ✓ Shortage Management
- ✓ Alternative Solution
- ✓ Excess Inventory Management