



## TMP302 Easy-to-Use, Low-Power, Low-Supply Temperature Switch in Micropackage

### 1 Features

- Low Power: 15  $\mu$ A (Maximum)
- SOT563 Package: 1.6-mm  $\times$  1.6-mm  $\times$  0.6 mm
- Trip-Point Accuracy:  $\pm 0.2^\circ\text{C}$  (Typical) From  $+40^\circ\text{C}$  to  $+125^\circ\text{C}$
- Pin-Selectable Trip Points
- Open-Drain Output
- Pin-Selectable Hysteresis:  $5^\circ\text{C}$  and  $10^\circ\text{C}$
- Low Supply Voltage Range: 1.4 V to 3.6 V

### 2 Applications

- Cell Phone Handsets
- Portable Media Players
- Consumer Electronics
- Servers
- Power-Supply Systems
- DC-DC Modules
- Thermal Monitoring
- Electronic Protection Systems

### 3 Description

The TMP302 device is a temperature switch in a micropackage (SOT563). The TMP302 offers low power (15- $\mu$ A maximum) and ease-of-use through pin-selectable trip points and hysteresis.

These devices require no additional components for operation; they can function independent of microprocessors or microcontrollers.

The TMP302 is available in several different versions. For additional trip points, contact a TI representative.

#### Device Information<sup>(1)</sup>

PART NUMBER	PACKAGE	SELECTABLE TRIP POINTS ( $^\circ\text{C}$ ) <sup>(2)</sup>
TMP302A	SOT (6)	50, 55, 60, 65
TMP302B	SOT (6)	70, 75, 80, 85
TMP302C	SOT (6)	90, 95, 100, 105
TMP302D	SOT (6)	110, 115, 120, 125

(1) For all available packages, see the orderable addendum at the end of the data sheet.

(2) For other available trip points, contact a TI representative.

**Trip Threshold Accuracy**

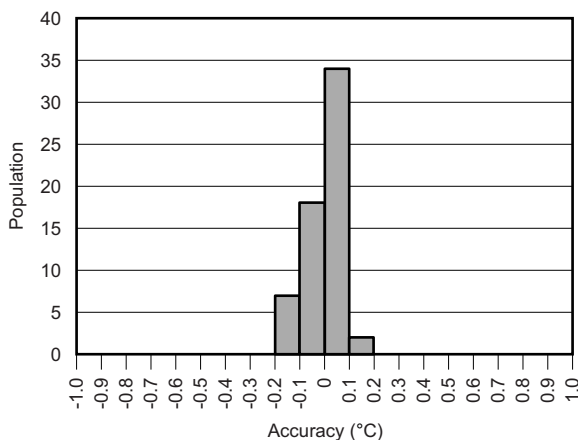

## Table of Contents

<b>1 Features</b> .....	<b>1</b>	7.4 Device Functional Modes.....	<b>8</b>
<b>2 Applications</b> .....	<b>1</b>	<b>8 Application and Implementation</b> .....	<b>9</b>
<b>3 Description</b> .....	<b>1</b>	8.1 Application Information.....	<b>9</b>
<b>4 Revision History</b> .....	<b>2</b>	8.2 Typical Application .....	<b>9</b>
<b>5 Pin Configuration and Functions</b> .....	<b>2</b>	<b>9 Power Supply Recommendations</b> .....	<b>11</b>
<b>6 Specifications</b> .....	<b>4</b>	<b>10 Layout</b> .....	<b>11</b>
6.1 Absolute Maximum Ratings .....	4	10.1 Layout Guidelines .....	11
6.2 ESD Ratings.....	4	10.2 Layout Example .....	11
6.3 Recommended Operating Conditions.....	4	<b>11 Device and Documentation Support</b> .....	<b>12</b>
6.4 Thermal Information .....	4	11.1 Receiving Notification of Documentation Updates	12
6.5 Electrical Characteristics.....	5	11.2 Community Resources.....	12
6.6 Typical Characteristics.....	5	11.3 Trademarks .....	12
<b>7 Detailed Description</b> .....	<b>7</b>	11.4 Electrostatic Discharge Caution.....	12
7.1 Overview .....	7	11.5 Glossary .....	12
7.2 Functional Block Diagram .....	7	<b>12 Mechanical, Packaging, and Orderable</b>	
7.3 Feature Description.....	8	<b>Information</b> .....	<b>12</b>

## 4 Revision History

NOTE: Page numbers for previous revisions may differ from page numbers in the current version.

### Changes from Revision D (October 2018) to Revision E Page

- Changed the input pin supply voltage maximum value from: :  $V_S + 0.5$  and  $\leq 4$  V to: :  $V_S + 0.3$  and  $\leq 4$  V ..... **4**

### Changes from Revision B (December 2014) to Revision C Page

- Changed device names by simplifying from TMP302A, TMP302B, TMP302C, and TMP302D to TMP302 ..... **1**
- Added plus-minus symbol to Machine Model value in *ESD Ratings* table..... **4**
- Moved Specified Operating Temperature parameter from *Electrical Characteristics* table to *Recommended Operating Conditions* table ..... **4**
- Added *Community Resources* section ..... **12**

### Changes from Revision A (September 2009) to Revision B Page

- Added *ESD Ratings* table, *Feature Description* section, *Device Functional Modes*, *Application and Implementation* section, *Power Supply Recommendations* section, *Layout* section, *Device and Documentation Support* section, and *Mechanical, Packaging, and Orderable Information* section: ..... **1**

## 5 Pin Configuration and Functions

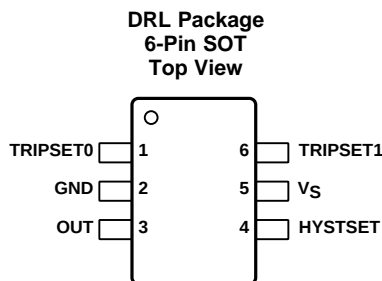

### Pin Functions

PIN		TYPE	DESCRIPTION
NO.	NAME		
1	TRIPSET0	Digital Input	Used in combination with TRIPSET1 to select the temperature at which the device trips
2	GND	Ground	Ground
3	$\overline{\text{OUT}}$	Digital Output	Open drain, active-low output
4	HYSTSET	Digital Input	Used to set amount of thermal hysteresis
5	$V_S$	Power Supply	Power supply
6	TRIPSET1	Digital Input	Used in combination with TRIPSET0 to select the temperature at which the device trips

## 6 Specifications

### 6.1 Absolute Maximum Ratings

 over operating free-air temperature range (unless otherwise noted)<sup>(1)</sup>

		MIN	MAX	UNIT
Voltage	Supply		4	V
	Input pin (TRIPSET0, TRIPSET1, HYSTSET)	-0.5	$V_S + 0.3$ and $\leq 4$	
	Output pin ( $\overline{\text{OUT}}$ )	-0.5	4	
Current	Output pin ( $\overline{\text{OUT}}$ )		10	mA
Temperature	Operating	-55	130	°C
	Junction		150	
	Storage	-60	150	

(1) Stresses beyond those listed under *Absolute Maximum Ratings* may cause permanent damage to the device. These are stress ratings only, which do not imply functional operation of the device at these or any other conditions beyond those indicated under *Recommended Operating Conditions*. Exposure to absolute-maximum-rated conditions for extended periods may affect device reliability.

### 6.2 ESD Ratings

		VALUE	UNIT
$V_{\text{(ESD)}}$ Electrostatic discharge	Human-body model (HBM), per ANSI/ESDA/JEDEC JS-001 <sup>(1)</sup>	±2000	V
	Charged-device model (CDM), per JEDEC specification JESD22-C101 <sup>(2)</sup>	±1000	
	Machine model (MM)	±500	

(1) JEDEC document JEP155 states that 500-V HBM allows safe manufacturing with a standard ESD control process.

(2) JEDEC document JEP157 states that 250-V CDM allows safe manufacturing with a standard ESD control process.

### 6.3 Recommended Operating Conditions

over operating free-air temperature range (unless otherwise noted)

		MIN	NOM	MAX	UNIT
$V_S$	Power supply voltage	1.4	3.3	3.6	V
$R_{\text{pullup}}$	Pullup resistor connected from $\overline{\text{OUT}}$ to $V_S$	10		100	k $\Omega$
$T_A$	Specified temperature	-40		125	°C

### 6.4 Thermal Information

THERMAL METRIC <sup>(1)</sup>		TMP302	UNIT
		DRL (SOT)	
		6 PINS	
$R_{\theta\text{JA}}$	Junction-to-ambient thermal resistance	210.3	°C/W
$R_{\theta\text{JC(top)}}$	Junction-to-case (top) thermal resistance	105.0	°C/W
$R_{\theta\text{JB}}$	Junction-to-board thermal resistance	87.5	°C/W
$\Psi_{\text{JT}}$	Junction-to-top characterization parameter	6.1	°C/W
$\Psi_{\text{JB}}$	Junction-to-board characterization parameter	87.0	°C/W

(1) For more information about traditional and new thermal metrics, see the [Semiconductor and IC Package Thermal Metrics](#) application report (SPRA953).

## 6.5 Electrical Characteristics

At  $T_A = -40^\circ\text{C}$  to  $+125^\circ\text{C}$ , and  $V_S = 1.4$  to  $3.6$  V (unless otherwise noted). 100% of all units are production tested at  $T_A = 25^\circ\text{C}$ ; overtemperature specifications are specified by design.

PARAMETER	TEST CONDITIONS	MIN	TYP	MAX	UNIT
<b>TEMPERATURE MEASUREMENT</b>					
Trip point accuracy			$\pm 0.2$	$\pm 2$	$^\circ\text{C}$
Trip point accuracy versus supply			$\pm 0.2$	$\pm 0.5$	$^\circ\text{C}/\text{V}$
Trip point hysteresis	HYSTSET = GND		5		$^\circ\text{C}$
	HYSTSET = $V_S$		10		$^\circ\text{C}$
<b>TEMPERATURE TRIP POINT SET</b>					
Temperature trip point set	TRIPSET1 = GND, TRIPSET0 = GND		Default		$^\circ\text{C}$
	TRIPSET1 = GND, TRIPSET0 = $V_S$		Default + 5		$^\circ\text{C}$
	TRIPSET1 = $V_S$ , TRIPSET0 = GND		Default + 10		$^\circ\text{C}$
	TRIPSET1 = $V_S$ , TRIPSET0 = $V_S$		Default + 15		$^\circ\text{C}$
<b>HYSTERESIS SET INPUT</b>					
$V_{IH}$ Input logic level high		$0.7 \times V_S$		$V_S$	V
$V_{IL}$ Input logic level low		-0.5		$0.3 \times V_S$	V
$I_I$ Input current	$0 < V_I < 3.6$ V			1	$\mu\text{A}$
<b>DIGITAL OUTPUT</b>					
$V_{OL}$ Output logic level low	$V_S > 2$ V, $I_{OL} = 3$ mA	0		0.4	V
	$V_S < 2$ V, $I_{OL} = 3$ mA	0		$0.2 \times V_S$	V
<b>POWER SUPPLY</b>					
Operating Supply Range		1.4		3.6	V
$I_Q$ Quiescent Current	$T_A = -40^\circ\text{C}$ to $+125^\circ\text{C}$		8	15	$\mu\text{A}$
	$V_S = 3.3$ V, $T_A = 50^\circ\text{C}$		7		$\mu\text{A}$

## 6.6 Typical Characteristics

At  $T_A = 25^\circ\text{C}$  and  $V_S = 3.3$  V, unless otherwise noted.

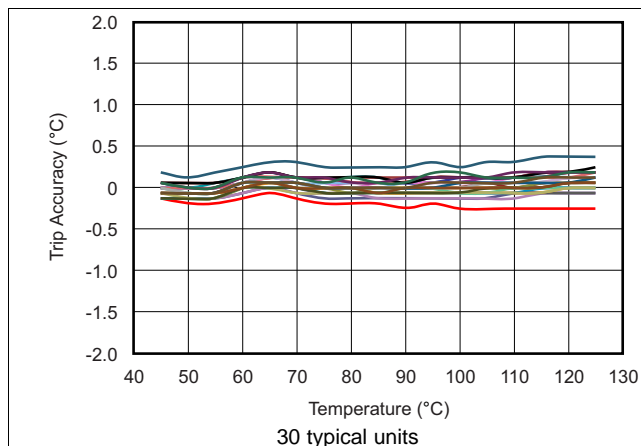

Figure 1. Trip Accuracy Error vs Temperature

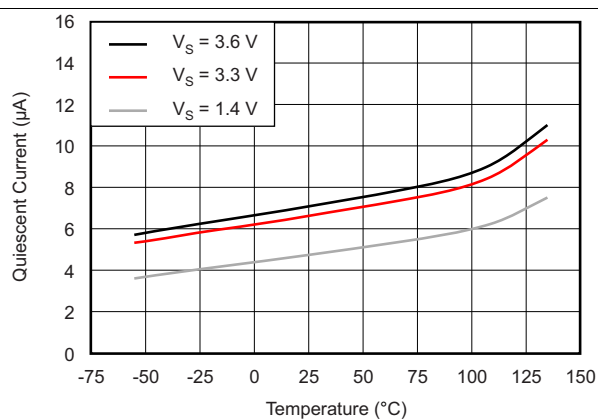

Figure 2. Quiescent Current vs Temperature

### Typical Characteristics (continued)

At  $T_A = 25^\circ\text{C}$  and  $V_S = 3.3\text{ V}$ , unless otherwise noted.

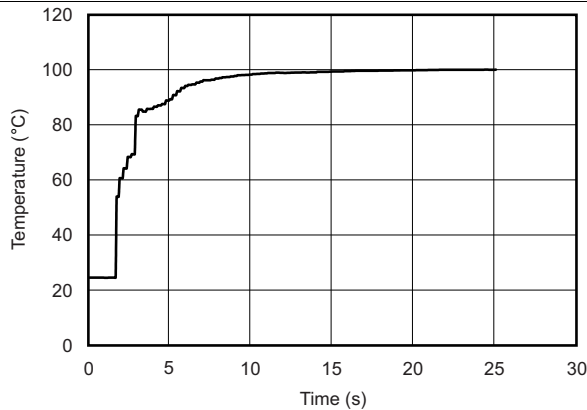

Figure 3. Temperature Step Response in Perfluorinated Fluid at 100°C vs Time

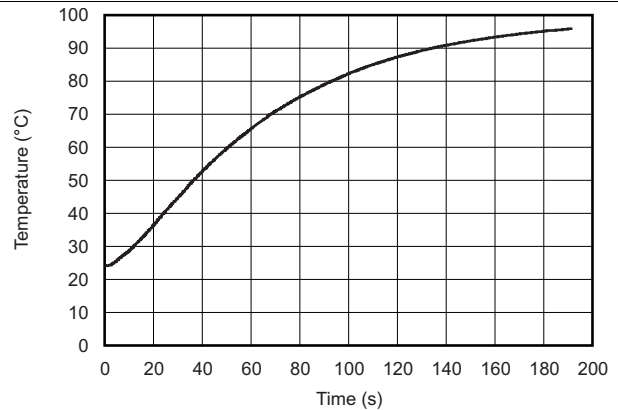

Figure 4. Thermal Step Response in Air at 100°C vs Time

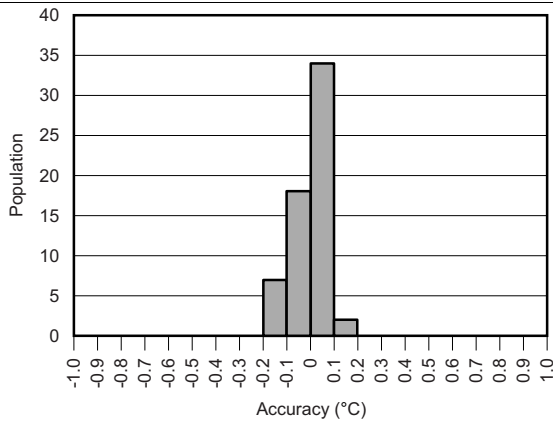

Figure 5. Trip Threshold Accuracy

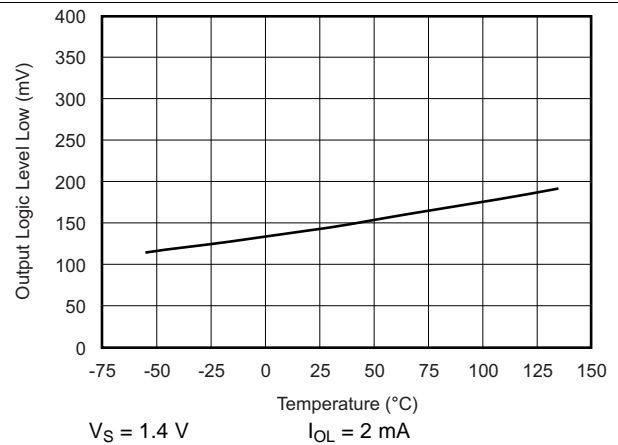

Figure 6. Output Logic-Level Low  $V_{OL}$  vs Temperature

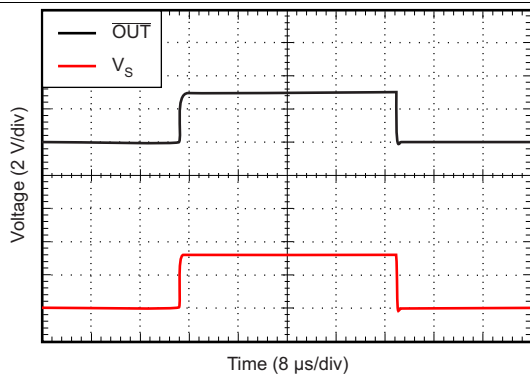

Figure 7. Power-Up and Power-Down Response

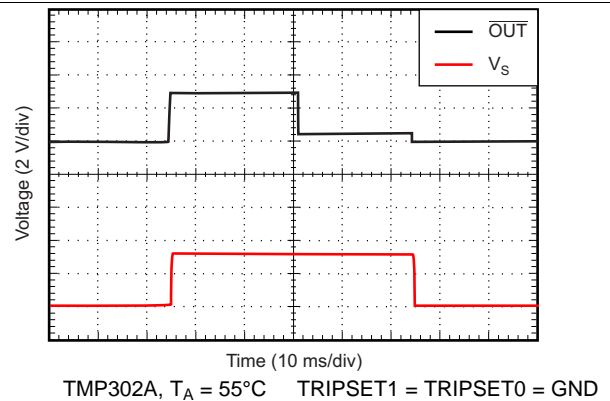

Figure 8. Power-Up, Trip, and Power-Down Response

## 7 Detailed Description

### 7.1 Overview

The TMP302 temperature switch is optimal for ultra low-power applications that require accurate trip thresholds. A temperature switch is a device that issues an alert response when a temperature threshold is reached or exceeded. The trip thresholds are programmable to four different settings using the TRIPSET1 and TRIPSET0 pins. Table 1 lists the pin settings versus trip points.

**Table 1. Trip Point versus TRIPSET1 and TRIPSET0**

TRIPSET1	TRIPSET0	TMP302A	TMP302B	TMP302C	TMP302D
GND	GND	50°C	70°C	90°C	110°C
GND	V <sub>S</sub>	55°C	75°C	95°C	115°C
V <sub>S</sub>	GND	60°C	80°C	100°C	120°C
V <sub>S</sub>	V <sub>S</sub>	65°C	85°C	105°C	125°C

### 7.2 Functional Block Diagram

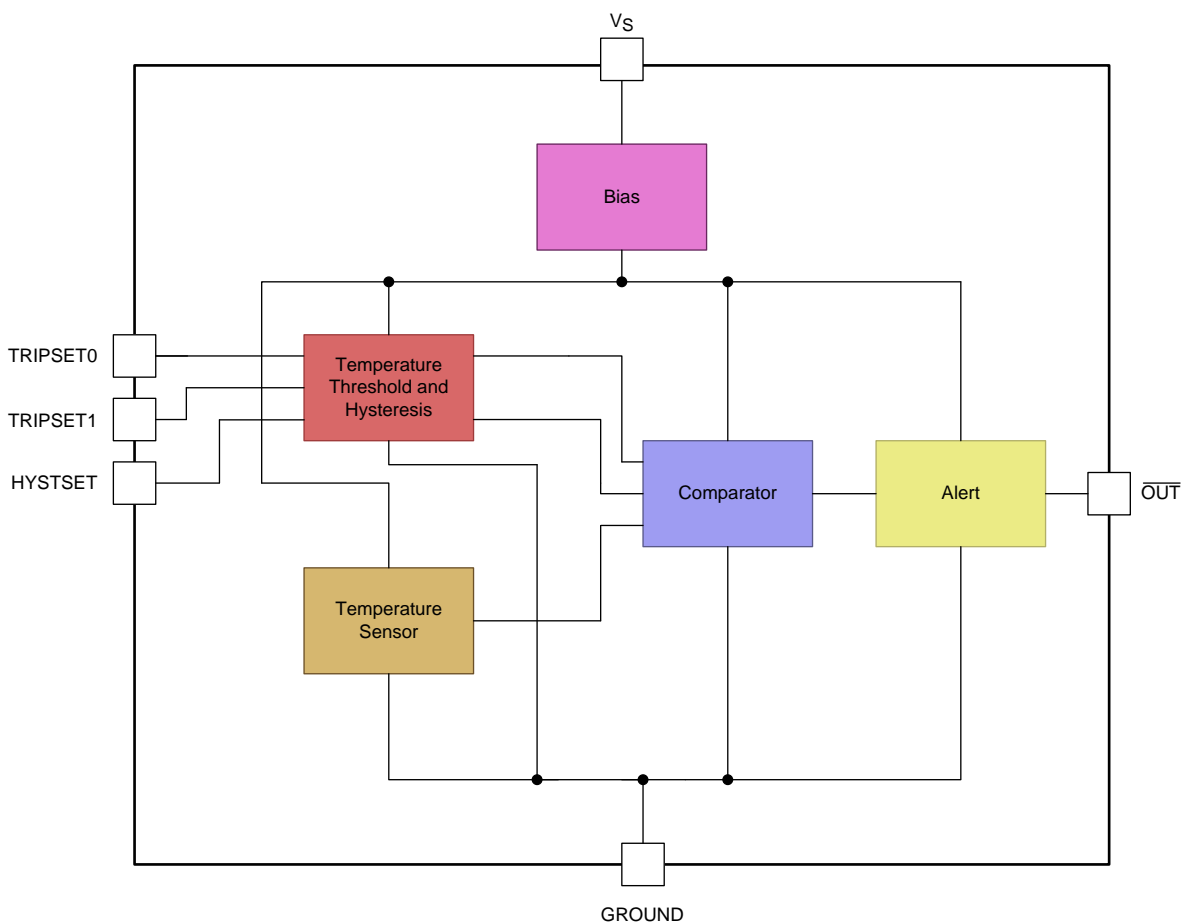

## 7.3 Feature Description

### 7.3.1 HYSTSET

If the temperature trip threshold is crossed, the open-drain, active low output ( $\overline{\text{OUT}}$ ) goes low and does not return to the original high state (that is,  $V_S$ ) until the temperature returns to a value within a hysteresis window set by the HYSTSET pin. The HYSTSET pin allows the user to choose between a 5°C and a 10°C hysteresis window. [Table 2](#) lists the hysteresis window that corresponds to the HYSTSET setting.

**Table 2. HYSTSET Window**

HYSTSET	THRESHOLD HYSTERESIS
GND	5°C
$V_S$	10°C

For the specific case of the device, if the HYSTSET pin is set to 10°C (that is, connected to  $V_S$ ) and the device is configured with a 60°C trip point ( $\text{TRIPSET1} = V_S$ ,  $\text{TRIPSET0} = \text{GND}$ ), when this threshold is exceeded the output does not return to the original high state until it reaches 50°C. This case is more clearly shown in [Figure 9](#).

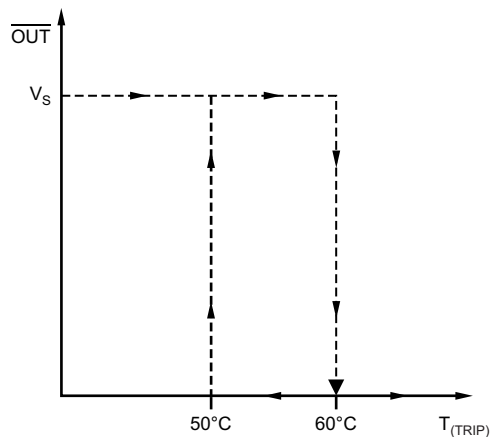

**Figure 9. TMP302A: HYSTSET =  $V_S$ , TRIPSET1 =  $V_S$ , TRIPSET0 = GND**

## 7.4 Device Functional Modes

The TMP302 family of devices has a single functional mode. Normal operation for the TMP302 family of devices occurs when the power-supply voltage applied between the  $V_S$  pin and GND is within the specified operating range of 1.4 to 3.6 V. The temperature threshold is selected by connecting the TRIPSET0 and TRIPSET1 pins to either the GND or  $V_S$  pins (see [Table 1](#)). Hysteresis is selected by connecting the HYSTSET pin to either the GND or  $V_S$  pins (see [Table 2](#)). The output pin,  $\overline{\text{OUT}}$ , remains high when the temperature is below the selected temperature threshold. The  $\overline{\text{OUT}}$  pin remains low when the temperature is at or above the selected temperature threshold. The  $\overline{\text{OUT}}$  pin returns from a low state back to the high state based upon the amount of selected hysteresis (see the [HYSTSET](#) section).

## 8 Application and Implementation

### NOTE

Information in the following applications sections is not part of the TI component specification, and TI does not warrant its accuracy or completeness. TI's customers are responsible for determining suitability of components for their purposes. Customers should validate and test their design implementation to confirm system functionality.

### 8.1 Application Information

#### 8.1.1 Configuring the TMP302

The TMP302 family of devices is simple to configure. The only external components that the device requires are a bypass capacitor and pullup resistor. Power-supply bypassing is strongly recommended. Use a 0.1- $\mu$ F capacitor placed as close as possible to the supply pin. To minimize the internal power dissipation of the TMP302 family of devices, use a pullup resistor value greater than 10 k $\Omega$  from the  $\overline{\text{OUT}}$  pin to the  $V_S$  pin. Refer to Table 1 for trip-point temperature configuration. The TRIPSET pins can be toggled dynamically; however, the voltage of these pins must not exceed  $V_S$ . To ensure a proper logic high, the voltage must not drop below  $0.7 V \times V_S$ .

### 8.2 Typical Application

Figure 10 shows the typical circuit configuration for the TMP302 family of devices. The TMP302 family of devices is configured for the default temperature threshold by connecting the TRIPSET0 and TRIPSET1 pins directly to ground. Connecting the HYSTSET pin to ground configures the device for 5°C of hysteresis. Place a 10-k $\Omega$  pullup resistor between the  $\overline{\text{OUT}}$  and  $V_S$  pins. Place a 0.1- $\mu$ F bypass capacitor between the  $V_S$  pin and ground, close to the TMP302 device.

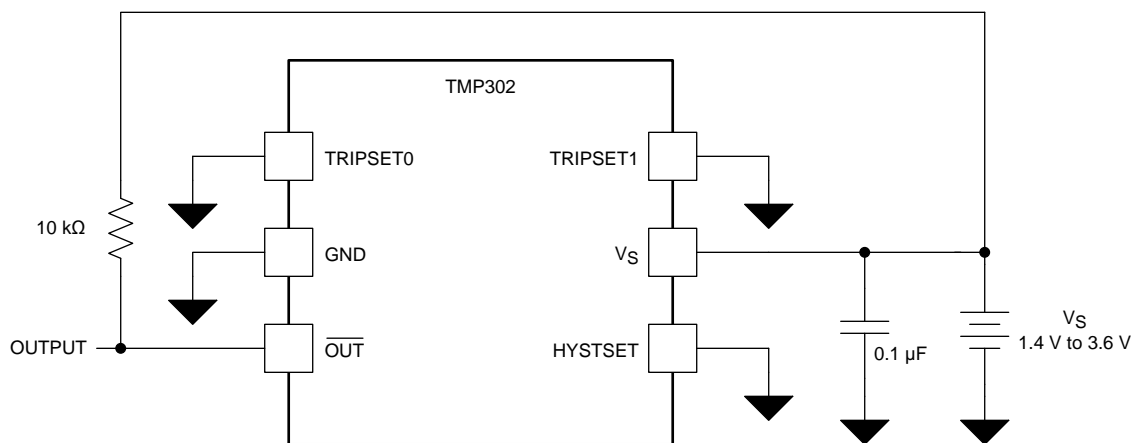
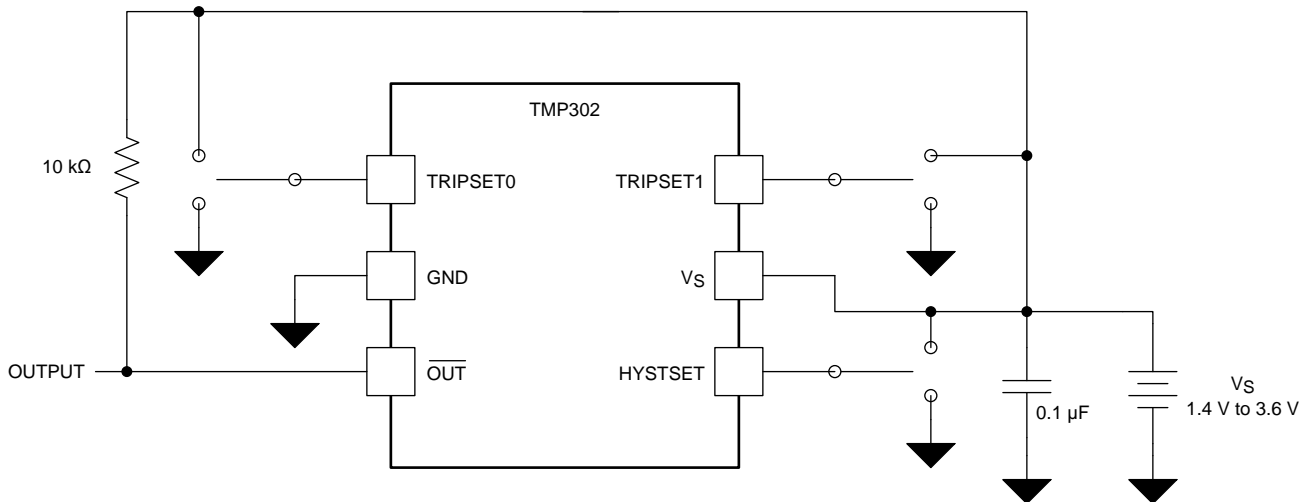

Figure 10. TMP302 Typical Application Schematic

Figure 11 shows the most generic implementation of the TMP302 family of devices. Switches are shown connecting the TRIPSET0, TRIPSET1 and HYSTSET pins to either  $V_S$  or ground. The use of switches is not strictly required; the switches are shown only to illustrate the various pin connection combinations. In practice, connecting the TRIPSET0, TRIPSET1 and HYSTSET pins to ground or directly to the  $V_S$  pin is sufficient and minimizes space and cost. If additional flexibility is desired, connections from the TRIPSET0, TRIPSET1 and HYSTSET pins can be made through 0- $\Omega$  resistors which can be either populated or not populated depending upon the desired connection.

## Typical Application (continued)



**Figure 11. TMP302 Generic Application Schematic**

### 8.2.1 Design Requirements

Designing with the TMP302 family of devices is simple. The TMP302 family of devices is a temperature switch commonly used to signal a microprocessor in the event of an over temperature condition. The temperature at which the TMP302 family of devices issues an active low alert is determined by the configuration of the TRIPSET0 and TRIPSET1 pins. These two pins are digital inputs and must be tied either high or low, according to Table 1. The TMP302 family of devices issues an active low alert when the temperature threshold is exceeded. The device has built-in hysteresis to avoid the device from signaling the microprocessor as soon as the temperature drops below the temperature threshold. The amount of hysteresis is determined by the HYSTSET pin. This pin is a digital input and must be tied either high or low, according to Table 2.

See Figure 10 and Figure 11 for typical circuit configurations.

### 8.2.2 Detailed Design Procedure

Determine the threshold temperature and hysteresis required for the application. Connect the TRIPSET0, TRIPSET1, and HYSTSET pins according to the design requirements. Refer to Table 1 and Table 2. Use a 10-kΩ pullup resistor from the  $\overline{\text{OUT}}$  pin to the  $V_S$  pin. To minimize power, a larger-value pullup resistor can be used but must not exceed 100 kΩ. Place a 0.1-μF bypass capacitor close to the TMP302 device to reduce noise coupled from the power supply.

### 8.2.3 Application Curves

Figure 12 and Figure 13 show the TMP302A power-on response with the ambient temperature less than 50°C and greater than 50°C respectively. The TMP302A was configured with trip point set to 50°C. The TMP302B, TMP302C, and TMP302D devices behave similarly with regards to power on response with  $T_A$  below or above the trip point. Note that the  $\overline{\text{OUT}}$  signal typically requires 35 ms following power on to become valid.

Typical Application (continued)

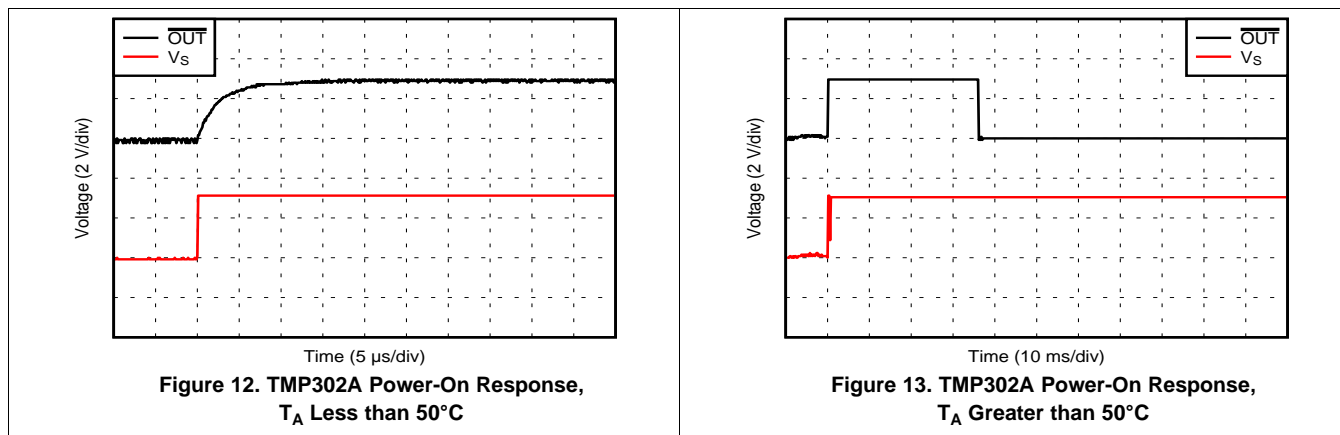

9 Power Supply Recommendations

The TMP302 family of devices is designed to operate from a single power supply within the range 1.4 V and 3.6 V. No specific power supply sequencing with respect to any of the input or output pins is required. The TMP302 family of devices is fully functional within 35 ms of the voltage at the  $V_S$  pin reaching or exceeding 1.4 V.

10 Layout

10.1 Layout Guidelines

Place the power supply bypass capacitor as close as possible to the  $V_S$  and GND pins. The recommended value for this bypass capacitor is 0.1- $\mu\text{F}$ . Additional bypass capacitance can be added to compensate for noisy or high-impedance power supplies. Place a 10-k $\Omega$  pullup resistor from the open drain  $\text{OUT}$  pin to the power supply pin  $V_S$ .

10.2 Layout Example

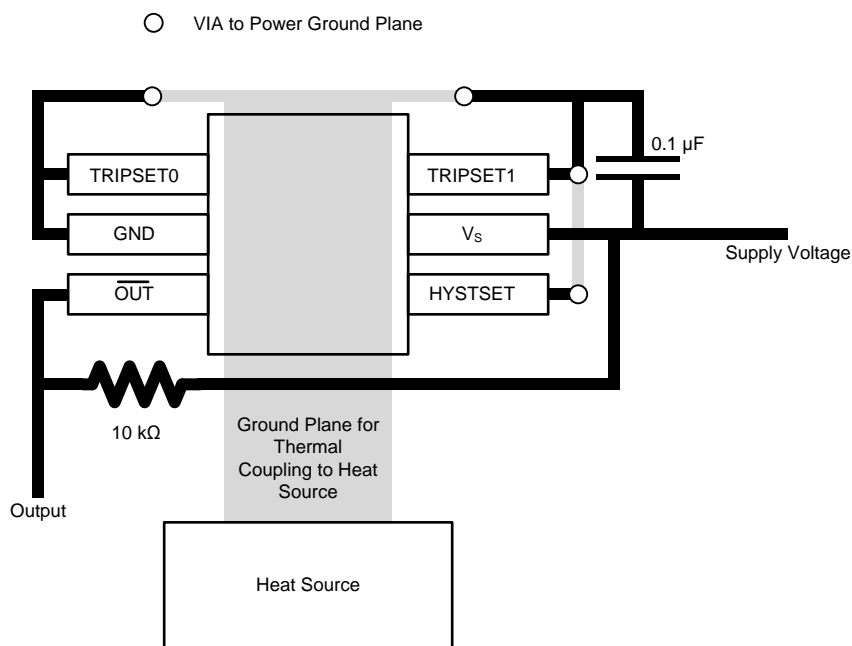

Figure 14. Layout Example

## 11 Device and Documentation Support

### 11.1 Receiving Notification of Documentation Updates

To receive notification of documentation updates, navigate to the device product folder on ti.com. In the upper right corner, click on *Alert me* to register and receive a weekly digest of any product information that has changed. For change details, review the revision history included in any revised document.

### 11.2 Community Resources

The following links connect to TI community resources. Linked contents are provided "AS IS" by the respective contributors. They do not constitute TI specifications and do not necessarily reflect TI's views; see TI's [Terms of Use](#).

**TI E2E™ Online Community** *TI's Engineer-to-Engineer (E2E) Community*. Created to foster collaboration among engineers. At e2e.ti.com, you can ask questions, share knowledge, explore ideas and help solve problems with fellow engineers.

**Design Support** *TI's Design Support* Quickly find helpful E2E forums along with design support tools and contact information for technical support.

### 11.3 Trademarks

E2E is a trademark of Texas Instruments.  
All other trademarks are the property of their respective owners.

### 11.4 Electrostatic Discharge Caution



This integrated circuit can be damaged by ESD. Texas Instruments recommends that all integrated circuits be handled with appropriate precautions. Failure to observe proper handling and installation procedures can cause damage.

ESD damage can range from subtle performance degradation to complete device failure. Precision integrated circuits may be more susceptible to damage because very small parametric changes could cause the device not to meet its published specifications.

### 11.5 Glossary

**SLYZ022** — *TI Glossary*.

This glossary lists and explains terms, acronyms, and definitions.

## 12 Mechanical, Packaging, and Orderable Information

The following pages include mechanical, packaging, and orderable information. This information is the most current data available for the designated devices. This data is subject to change without notice and revision of this document. For browser-based versions of this data sheet, refer to the left-hand navigation.

**PACKAGING INFORMATION**

Orderable Device	Status (1)	Package Type	Package Drawing	Pins	Package Qty	Eco Plan (2)	Lead/Ball Finish (6)	MSL Peak Temp (3)	Op Temp (°C)	Device Marking (4/5)	Samples
TMP302ADRLR	ACTIVE	SOT-5X3	DRL	6	4000	Green (RoHS & no Sb/Br)	CU NIPDAU   CU NIPDAUAG	Level-1-260C-UNLIM	-40 to 125	OCP	<a href="#">Samples</a>
TMP302ADRLT	ACTIVE	SOT-5X3	DRL	6	250	Green (RoHS & no Sb/Br)	CU NIPDAU   CU NIPDAUAG	Level-1-260C-UNLIM	-40 to 125	OCP	<a href="#">Samples</a>
TMP302BDRLR	ACTIVE	SOT-5X3	DRL	6	4000	Green (RoHS & no Sb/Br)	CU NIPDAU   CU NIPDAUAG	Level-1-260C-UNLIM	-40 to 125	OCT	<a href="#">Samples</a>
TMP302BDRLT	ACTIVE	SOT-5X3	DRL	6	250	Green (RoHS & no Sb/Br)	CU NIPDAU   CU NIPDAUAG	Level-1-260C-UNLIM	-40 to 125	OCT	<a href="#">Samples</a>
TMP302CDRLR	ACTIVE	SOT-5X3	DRL	6	4000	Green (RoHS & no Sb/Br)	CU NIPDAU   CU NIPDAUAG	Level-1-260C-UNLIM	-40 to 125	OCR	<a href="#">Samples</a>
TMP302CDRLT	ACTIVE	SOT-5X3	DRL	6	250	Green (RoHS & no Sb/Br)	CU NIPDAU   CU NIPDAUAG	Level-1-260C-UNLIM	-40 to 125	OCR	<a href="#">Samples</a>
TMP302DDRLR	ACTIVE	SOT-5X3	DRL	6	4000	Green (RoHS & no Sb/Br)	CU NIPDAU   CU NIPDAUAG	Level-1-260C-UNLIM	-40 to 125	OCS	<a href="#">Samples</a>
TMP302DDRLT	ACTIVE	SOT-5X3	DRL	6	250	Green (RoHS & no Sb/Br)	CU NIPDAU   CU NIPDAUAG	Level-1-260C-UNLIM	-40 to 125	OCS	<a href="#">Samples</a>

(1) The marketing status values are defined as follows:

**ACTIVE:** Product device recommended for new designs.

**LIFEBUY:** TI has announced that the device will be discontinued, and a lifetime-buy period is in effect.

**NRND:** Not recommended for new designs. Device is in production to support existing customers, but TI does not recommend using this part in a new design.

**PREVIEW:** Device has been announced but is not in production. Samples may or may not be available.

**OBSOLETE:** TI has discontinued the production of the device.

(2) **RoHS:** TI defines "RoHS" to mean semiconductor products that are compliant with the current EU RoHS requirements for all 10 RoHS substances, including the requirement that RoHS substance do not exceed 0.1% by weight in homogeneous materials. Where designed to be soldered at high temperatures, "RoHS" products are suitable for use in specified lead-free processes. TI may reference these types of products as "Pb-Free".

**RoHS Exempt:** TI defines "RoHS Exempt" to mean products that contain lead but are compliant with EU RoHS pursuant to a specific EU RoHS exemption.

**Green:** TI defines "Green" to mean the content of Chlorine (Cl) and Bromine (Br) based flame retardants meet JS709B low halogen requirements of <=100ppm threshold. Antimony trioxide based flame retardants must also meet the <=1000ppm threshold requirement.

(3) MSL, Peak Temp. - The Moisture Sensitivity Level rating according to the JEDEC industry standard classifications, and peak solder temperature.

(4) There may be additional marking, which relates to the logo, the lot trace code information, or the environmental category on the device.

(5) Multiple Device Markings will be inside parentheses. Only one Device Marking contained in parentheses and separated by a "-" will appear on a device. If a line is indented then it is a continuation of the previous line and the two combined represent the entire Device Marking for that device.

(6) Lead/Ball Finish - Orderable Devices may have multiple material finish options. Finish options are separated by a vertical ruled line. Lead/Ball Finish values may wrap to two lines if the finish value exceeds the maximum column width.

**Important Information and Disclaimer:**The information provided on this page represents TI's knowledge and belief as of the date that it is provided. TI bases its knowledge and belief on information provided by third parties, and makes no representation or warranty as to the accuracy of such information. Efforts are underway to better integrate information from third parties. TI has taken and continues to take reasonable steps to provide representative and accurate information but may not have conducted destructive testing or chemical analysis on incoming materials and chemicals. TI and TI suppliers consider certain information to be proprietary, and thus CAS numbers and other limited information may not be available for release.

In no event shall TI's liability arising out of such information exceed the total purchase price of the TI part(s) at issue in this document sold by TI to Customer on an annual basis.

**OTHER QUALIFIED VERSIONS OF TMP302 :**

- Automotive: [TMP302-Q1](#)

NOTE: Qualified Version Definitions:

- Automotive - Q100 devices qualified for high-reliability automotive applications targeting zero defects

**TAPE AND REEL INFORMATION**

**QUADRANT ASSIGNMENTS FOR PIN 1 ORIENTATION IN TAPE**

\*All dimensions are nominal

Device	Package Type	Package Drawing	Pins	SPQ	Reel Diameter (mm)	Reel Width W1 (mm)	A0 (mm)	B0 (mm)	K0 (mm)	P1 (mm)	W (mm)	Pin1 Quadrant
TMP302ADRLR	SOT-5X3	DRL	6	4000	180.0	8.4	1.98	1.78	0.69	4.0	8.0	Q3
TMP302ADRLT	SOT-5X3	DRL	6	250	180.0	8.4	1.98	1.78	0.69	4.0	8.0	Q3
TMP302BDRLR	SOT-5X3	DRL	6	4000	180.0	9.5	1.78	1.78	0.69	4.0	8.0	Q3
TMP302BDRLR	SOT-5X3	DRL	6	4000	180.0	8.4	1.98	1.78	0.69	4.0	8.0	Q3
TMP302BDRLT	SOT-5X3	DRL	6	250	180.0	8.4	1.98	1.78	0.69	4.0	8.0	Q3
TMP302BDRLT	SOT-5X3	DRL	6	250	180.0	9.5	1.78	1.78	0.69	4.0	8.0	Q3
TMP302CDRLR	SOT-5X3	DRL	6	4000	180.0	8.4	1.98	1.78	0.69	4.0	8.0	Q3
TMP302CDRLR	SOT-5X3	DRL	6	4000	180.0	9.5	1.78	1.78	0.69	4.0	8.0	Q3
TMP302CDRLT	SOT-5X3	DRL	6	250	180.0	9.5	1.78	1.78	0.69	4.0	8.0	Q3
TMP302DDRLR	SOT-5X3	DRL	6	4000	180.0	8.4	1.98	1.78	0.69	4.0	8.0	Q3
TMP302DDRLR	SOT-5X3	DRL	6	4000	180.0	9.5	1.78	1.78	0.69	4.0	8.0	Q3
TMP302DDRLT	SOT-5X3	DRL	6	250	180.0	9.5	1.78	1.78	0.69	4.0	8.0	Q3
TMP302DDRLT	SOT-5X3	DRL	6	250	180.0	8.4	1.98	1.78	0.69	4.0	8.0	Q3

**TAPE AND REEL BOX DIMENSIONS**

\*All dimensions are nominal

Device	Package Type	Package Drawing	Pins	SPQ	Length (mm)	Width (mm)	Height (mm)
TMP302ADRLR	SOT-5X3	DRL	6	4000	202.0	201.0	28.0
TMP302ADRLT	SOT-5X3	DRL	6	250	202.0	201.0	28.0
TMP302BDRLR	SOT-5X3	DRL	6	4000	184.0	184.0	19.0
TMP302BDRLR	SOT-5X3	DRL	6	4000	202.0	201.0	28.0
TMP302BDRLT	SOT-5X3	DRL	6	250	202.0	201.0	28.0
TMP302BDRLT	SOT-5X3	DRL	6	250	184.0	184.0	19.0
TMP302CDRLR	SOT-5X3	DRL	6	4000	202.0	201.0	28.0
TMP302CDRLR	SOT-5X3	DRL	6	4000	184.0	184.0	19.0
TMP302CDRLT	SOT-5X3	DRL	6	250	184.0	184.0	19.0
TMP302DDRLR	SOT-5X3	DRL	6	4000	202.0	201.0	28.0
TMP302DDRLR	SOT-5X3	DRL	6	4000	184.0	184.0	19.0
TMP302DDRLT	SOT-5X3	DRL	6	250	184.0	184.0	19.0
TMP302DDRLT	SOT-5X3	DRL	6	250	202.0	201.0	28.0

# DRL0006A

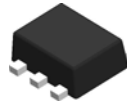

# PACKAGE OUTLINE

## SOT - 0.6 mm max height

PLASTIC SMALL OUTLINE

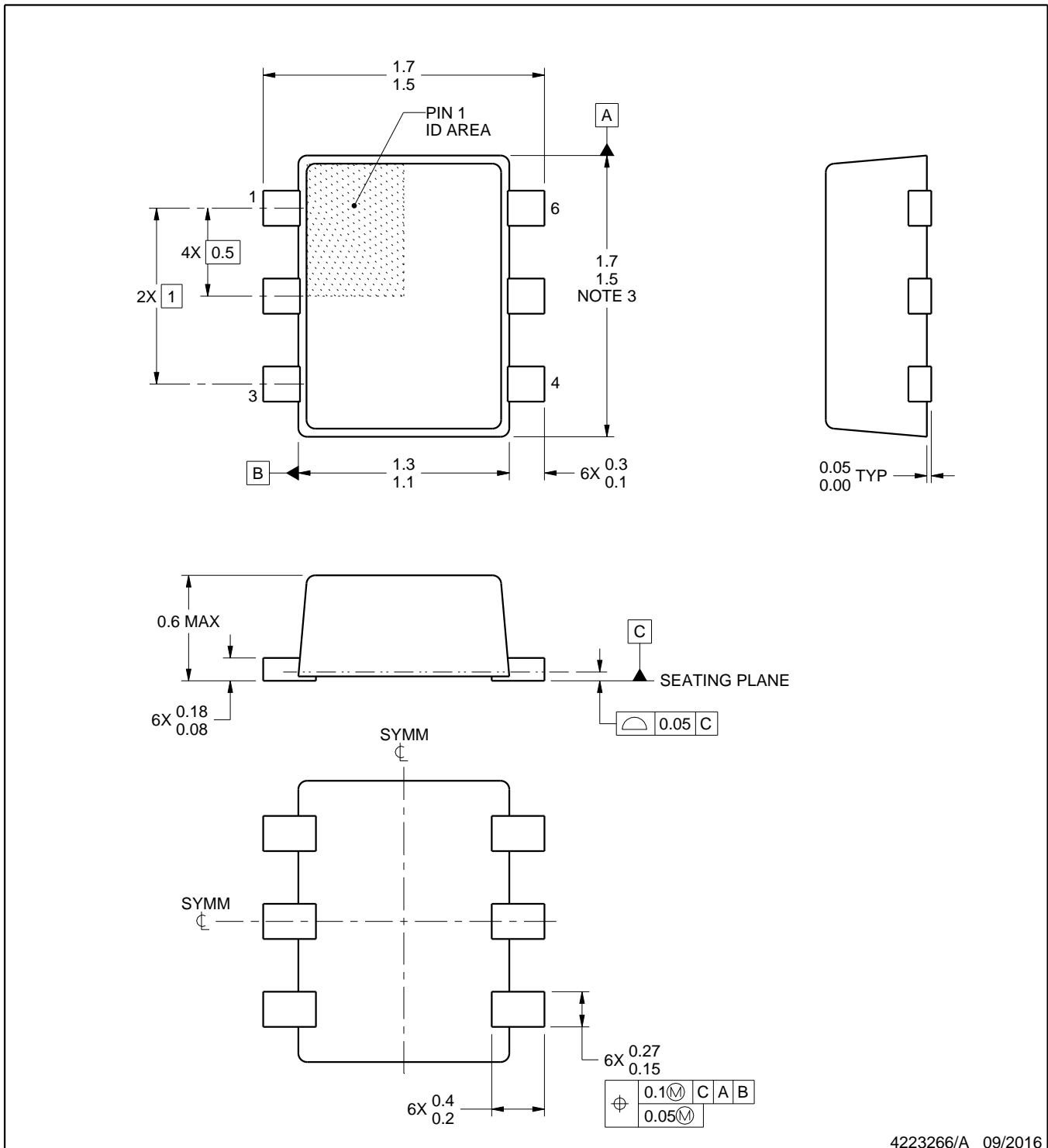

4223266/A 09/2016

### NOTES:

1. All linear dimensions are in millimeters. Any dimensions in parenthesis are for reference only. Dimensioning and tolerancing per ASME Y14.5M.
2. This drawing is subject to change without notice.
3. This dimension does not include mold flash, protrusions, or gate burrs. Mold flash, protrusions, or gate burrs shall not exceed 0.15 mm per side.

# EXAMPLE BOARD LAYOUT

DRL0006A

SOT - 0.6 mm max height

PLASTIC SMALL OUTLINE

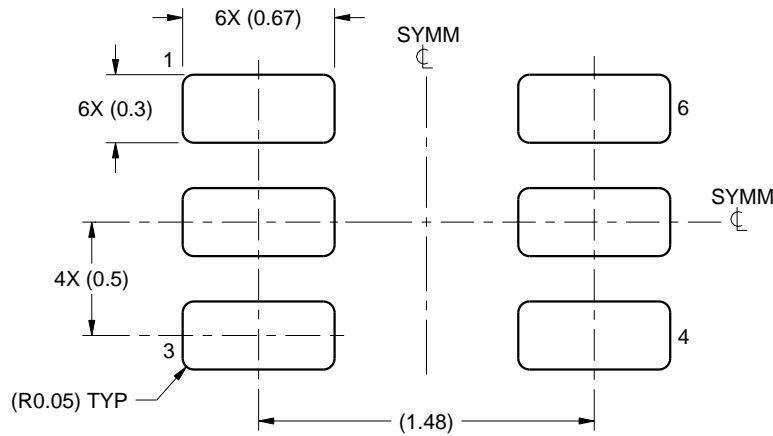

LAND PATTERN EXAMPLE  
SCALE:30X

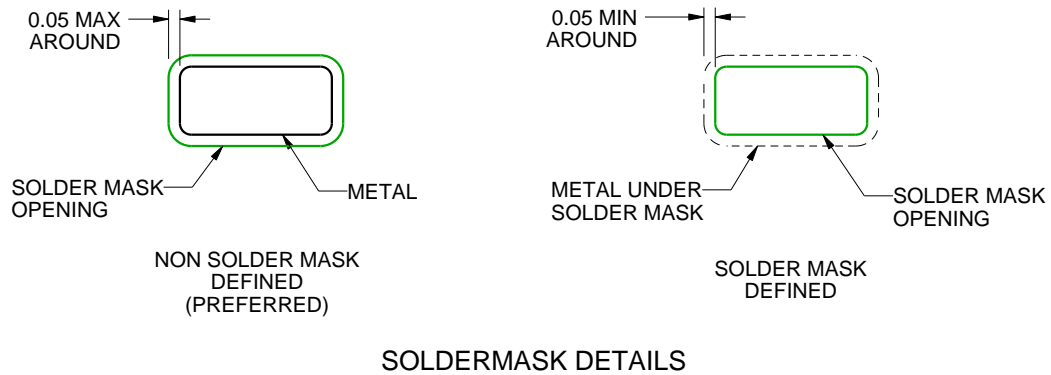

SOLDERMASK DETAILS

4223266/A 09/2016

NOTES: (continued)

- 4. Publication IPC-7351 may have alternate designs.
- 5. Solder mask tolerances between and around signal pads can vary based on board fabrication site.

# EXAMPLE STENCIL DESIGN

DRL0006A

SOT - 0.6 mm max height

PLASTIC SMALL OUTLINE

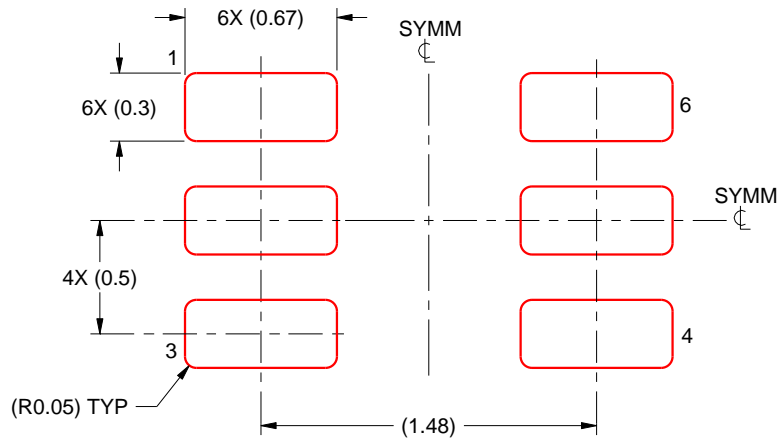

SOLDER PASTE EXAMPLE  
BASED ON 0.1 mm THICK STENCIL  
SCALE:30X

4223266/A 09/2016

NOTES: (continued)

6. Laser cutting apertures with trapezoidal walls and rounded corners may offer better paste release. IPC-7525 may have alternate design recommendations.
7. Board assembly site may have different recommendations for stencil design.

## IMPORTANT NOTICE AND DISCLAIMER

TI PROVIDES TECHNICAL AND RELIABILITY DATA (INCLUDING DATASHEETS), DESIGN RESOURCES (INCLUDING REFERENCE DESIGNS), APPLICATION OR OTHER DESIGN ADVICE, WEB TOOLS, SAFETY INFORMATION, AND OTHER RESOURCES "AS IS" AND WITH ALL FAULTS, AND DISCLAIMS ALL WARRANTIES, EXPRESS AND IMPLIED, INCLUDING WITHOUT LIMITATION ANY IMPLIED WARRANTIES OF MERCHANTABILITY, FITNESS FOR A PARTICULAR PURPOSE OR NON-INFRINGEMENT OF THIRD PARTY INTELLECTUAL PROPERTY RIGHTS.

These resources are intended for skilled developers designing with TI products. You are solely responsible for (1) selecting the appropriate TI products for your application, (2) designing, validating and testing your application, and (3) ensuring your application meets applicable standards, and any other safety, security, or other requirements. These resources are subject to change without notice. TI grants you permission to use these resources only for development of an application that uses the TI products described in the resource. Other reproduction and display of these resources is prohibited. No license is granted to any other TI intellectual property right or to any third party intellectual property right. TI disclaims responsibility for, and you will fully indemnify TI and its representatives against, any claims, damages, costs, losses, and liabilities arising out of your use of these resources.

TI's products are provided subject to TI's Terms of Sale ([www.ti.com/legal/termsofsale.html](http://www.ti.com/legal/termsofsale.html)) or other applicable terms available either on [ti.com](http://ti.com) or provided in conjunction with such TI products. TI's provision of these resources does not expand or otherwise alter TI's applicable warranties or warranty disclaimers for TI products.

Mailing Address: Texas Instruments, Post Office Box 655303, Dallas, Texas 75265  
Copyright © 2019, Texas Instruments Incorporated

## Looking for pricing, stock, or lifecycle information?

Click below to explore more details on WIN SOURCE:

 [View TMP302ADRLR on WIN SOURCE](#)

 [Texas Instruments](#) Information

## Optimize Your Supply Chain with WIN SOURCE Solutions

-  Global Sourcing Solution
-  Obsolete Management
-  Cost Control Management
-  Shortage Management
-  Alternative Solution
-  Excess Inventory Management