



**THE DATASHEET OF
TLV5636IDR**



2.7-V TO 5.5-V, LOW POWER, 12-BIT, DIGITAL-TO-ANALOG CONVERTER WITH INTERNAL REFERENCE AND POWER DOWN

FEATURES

- 12-Bit Voltage Output DAC
- Programmable Internal Reference
- Programmable Settling Time:
 - 1 μ s in Fast Mode
 - 3.5 μ s in Slow Mode
- Compatible With TMS320 and SPI™ Serial Ports
- Differential Nonlinearity . . . <0.5 LSB Typ
- Monotonic Over Temperature

APPLICATIONS

- Digital Servo Control Loops
- Digital Offset and Gain Adjustment
- Industrial Process Control
- Machine and Motion Control Devices
- Mass Storage Devices

D OR DGK PACKAGE
(TOP VIEW)

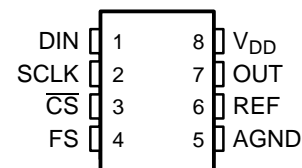

DESCRIPTION

The TLV5636 is a 12-bit voltage output DAC with a flexible 4-wire serial interface. The serial interface allows glueless interface to TMS320 and SPI™, QSPI™, and Microwire™ serial ports. It is programmed with a 16-bit serial string containing 4 control and 12 data bits.

The resistor string output voltage is buffered by a x2 gain rail-to-rail output buffer. The programmable settling time of the DAC allows the designer to optimize speed vs power dissipation. With its on-chip programmable precision voltage reference, the TLV5636 simplifies overall system design.

Because of its ability to source up to 1 mA, the reference can also be used as a system reference. Implemented with a CMOS process, the device is designed for single supply operation from 2.7 V to 5.5 V. It is available in an 8-pin SOIC and 8-pin MSOP package to reduce board space in standard commercial and industrial temperature ranges

AVAILABLE OPTIONS

T _A	PACKAGE	
	SOIC (D)	MSOP (DGK)
0°C to 70°C	TLV5636CD	TLV5636CDGK
-40°C to 85°C	TLV5636ID	TLV5636IDGK



Please be aware that an important notice concerning availability, standard warranty, and use in critical applications of Texas Instruments semiconductor products and disclaimers thereto appears at the end of this data sheet.

SPI, QSPI are trademarks of Motorola, Inc..

Microwire is a trademark of National Semiconductor Corporation.



These devices have limited built-in ESD protection. The leads should be shorted together or the device placed in conductive foam during storage or handling to prevent electrostatic damage to the MOS gates.

FUNCTIONAL BLOCK DIAGRAM

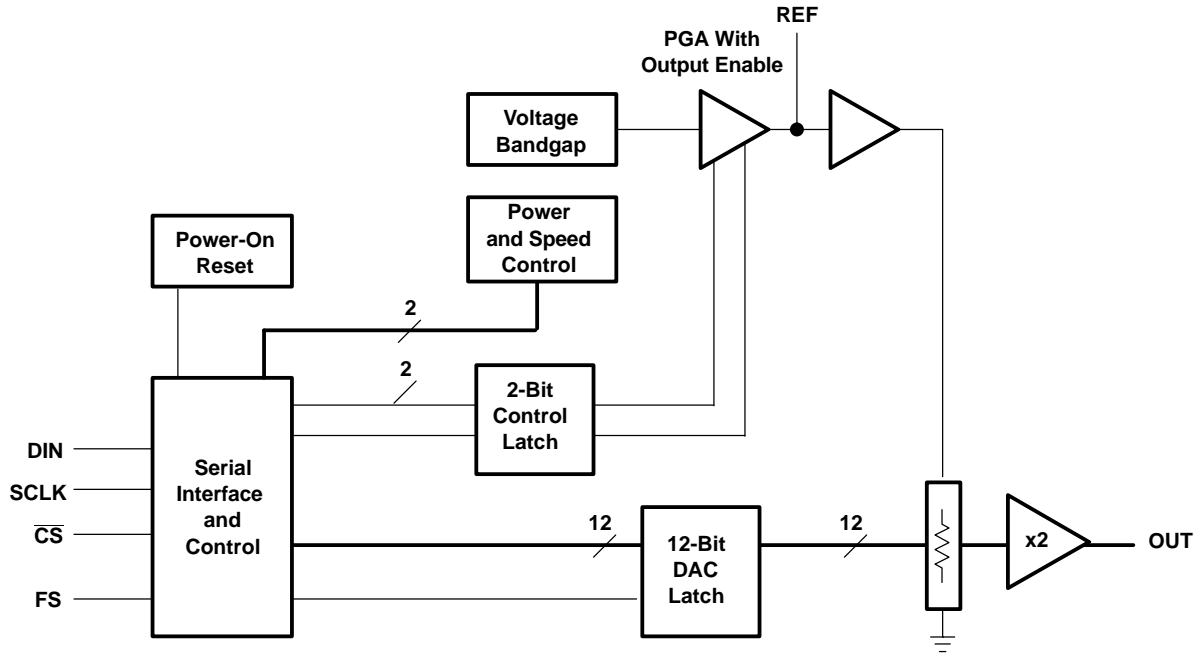

Terminal Functions

TERMINAL		I/O/P	DESCRIPTION
NAME	NO.		
AGND	5	P	Ground
\overline{CS}	3	I	Chip select. Digital input active low, used to enable/disable inputs
DIN	1	I	Digital serial data input
FS	4	I	Frame sync input
OUT	7	O	DAC A analog voltage output
REF	6	I/O	Analog reference voltage input/output
SCLK	2	I	Digital serial clock input
V_{DD}	8	P	Positive power supply

ABSOLUTE MAXIMUM RATINGS

over operating free-air temperature range (unless otherwise noted)⁽¹⁾

		UNIT
Supply voltage (V_{DD} to AGND)		7 V
Reference input voltage		- 0.3 V to $V_{DD} + 0.3$ V
Digital input voltage range		- 0.3 V to $V_{DD} + 0.3$ V
Operating free-air temperature range, T_A	TLV5636C	0°C to 70°C
	TLV5636I	-40°C to 85°C
Storage temperature range, T_{stg}		-65°C to 150°C
Lead temperature 1,6 mm (1/16 inch) from case for 10 seconds		260°C

(1) Stresses beyond those listed under *absolute maximum ratings* may cause permanent damage to the device. These are stress ratings only, and functional operation of the device at these or any other conditions beyond those indicated under *recommended operating conditions* is not implied. Exposure to absolute-maximum-rated conditions for extended periods may affect device reliability.

RECOMMENDED OPERATING CONDITIONS

		MIN	NOM	MAX	UNIT
Supply voltage, V_{DD}	$V_{DD} = 5$ V	4.5	5	5.5	V
	$V_{DD} = 3$ V	2.7	3	3.3	V
Power on Reset, POR		0.55		2	V
High-level digital input voltage, V_{IH}	$DV_{DD} = 2.7$ V	2			V
	$DV_{DD} = 5.5$ V	2.4			V
Low-level digital input voltage, V_{IL}	$DV_{DD} = 2.7$ V			0.6	V
	$DV_{DD} = 5.5$ V			1	V
Reference voltage, V_{ref} to REF terminal	$V_{DD} = 5$ V ⁽¹⁾	AGND	2.048	$V_{DD} - 1.5$	V
	$V_{DD} = 3$ V ⁽¹⁾	AGND	1.024	$V_{DD} - 1.5$	V
Load resistance, R_L		2			k Ω
Load capacitance, C_L				100	pF
Clock frequency, f_{CLK}				20	MHz
Operating free-air temperature, T_A	TLV5636C	0		70	°C
	TLV5636I	-40		85	°C

(1) Due to the x2 output buffer, a reference input voltage $(V_{DD} - 0.4$ V)/2 causes clipping of the transfer function. The output buffer of the internal reference must be disabled, if an external reference is used.

ELECTRICAL CHARACTERISTICS

over recommended operating free-air temperature range, supply voltages, and reference voltages (unless otherwise noted)

POWER SUPPLY							
PARAMETER		TEST CONDITIONS		MIN	TYP	MAX	UNIT
I_{DD}	Power supply current	No load, All inputs = AGND or V_{DD} , DAC latch = 0x800	Fast		2.3	3.3	mA
			Slow		1.5	1.9	
	Power-down supply current	See Figure 8			0.01	10	μ A
PSRR	Power supply rejection ratio	Zero scale ⁽¹⁾			-65		dB
		Full Scale ⁽²⁾			-65		

(1) Power supply rejection ratio at zero scale is measured by varying V_{DD} and is given by:

$$PSRR = 20 \log [(E_{ZS}(V_{DDmax}) - E_{ZS}(V_{DDmin})) / V_{DDmax}]$$

(2) Power supply rejection ratio at full scale is measured by varying V_{DD} and is given by:

$$PSRR = 20 \log [(E_G(V_{DDmax}) - E_G(V_{DDmin})) / V_{DDmax}]$$

ELECTRICAL CHARACTERISTICS

over recommended operating free-air temperature range, supply voltages, and reference voltages (unless otherwise noted)

STATIC DAC SPECIFICATIONS						
PARAMETER		TEST CONDITIONS	MIN	TYP	MAX	UNIT
Resolution			12			Bits
INL	Integral nonlinearity	See note (1)		±2	±4	LSB
DNL	Differential nonlinearity	See note (2)		±0.5	±1	LSB
E_{ZS}	Zero-scale error (offset error at zero scale)	See note (3)			±20	mV
E_{ZS} TC	Zero-scale-error temperature coefficient	See note (4)		10		$\mu\text{V}/^\circ\text{C}$
E_G	Gain error	See note (5)			±0.6	% of FS voltage
E_G TC	Gain error temperature coefficient	See note (6)		10		ppm/ $^\circ\text{C}$

- (1) The relative accuracy or integral nonlinearity (INL) sometimes referred to as linearity error, is the maximum deviation of the output from the line between zero and full scale excluding the effects of zero code and full-scale errors. Tested from code 10 to code 4095.
- (2) The differential nonlinearity (DNL) sometimes referred to as differential error, is the difference between the measured and ideal 1 LSB amplitude change of any two adjacent codes. Monotonic means the output voltage changes in the same direction (or remains constant) as a change in the digital input code. Tested from code 10 to code 4095.
- (3) Zero-scale error is the deviation from zero voltage output when the digital input code is zero.
- (4) Zero-scale-error temperature coefficient is given by: $E_{ZS} \text{ TC} = [E_{ZS} (T_{\text{max}}) - E_{ZS} (T_{\text{min}})]/V_{\text{ref}} \times 10^6/(T_{\text{max}} - T_{\text{min}})$.
- (5) Gain error is the deviation from the ideal output ($2V_{\text{ref}} - 1 \text{ LSB}$) with an output load of 10 k Ω excluding the effects of the zero-error.
- (6) Gain error temperature coefficient is given by: $E_G \text{ TC} = [E_G (T_{\text{max}}) - E_G (T_{\text{min}})]/V_{\text{ref}} \times 10^6/(T_{\text{max}} - T_{\text{min}})$.

OUTPUT SPECIFICATIONS						
PARAMETER		TEST CONDITIONS	MIN	TYP	MAX	UNIT
V_O	Voltage output range	$R_L = 10 \text{ k}\Omega$	0		$V_{DD} - 0.4$	V
Output load regulation accuracy		$V_O = 4.096 \text{ V}, 2.048 \text{ V}, R_L = 2 \text{ k}\Omega$			±0.25	% of FS voltage

REFERENCE PIN CONFIGURED AS OUTPUT (REF)

PARAMETER		TEST CONDITIONS	MIN	TYP	MAX	UNIT
$V_{\text{ref(OUTL)}}$	Low reference voltage		1.003	1.024	1.045	V
$V_{\text{ref(OUTH)}}$	High reference voltage	$V_{DD} > 4.75 \text{ V}$	2.027	2.048	2.068	V
$I_{\text{ref(source)}}$	Output source current				1	mA
$I_{\text{ref(sink)}}$	Output sink current		-1			mA
Load capacitance					100	pF
PSRR	Power supply rejection ratio			-65		dB

REFERENCE INPUT CONFIGURED AS INPUT (REF)

PARAMETER		TEST CONDITIONS	MIN	TYP	MAX	UNIT
V_I	Input voltage		0		$V_{DD} - 1.5$	V
R_i	Input resistance			10		k Ω
C_i	Input capacitance			5		pF
Reference input bandwidth		REF = 0.2 V_{pp} + 1.024 V dc	Fast	1.3		MHz
			Slow	525		
Reference feed through		REF = 1 V_{pp} at 1 kHz + 1.024 V dc ⁽¹⁾		-80		dB

- (1) Reference feedthrough is measured at the DAC output with an input code = 0x000.

DIGITAL INPUT						
PARAMETER		TEST CONDITIONS	MIN	TYP	MAX	UNIT
I_{IH}	High-level digital input current	$V_I = V_{DD}$			1	μA
I_{IL}	Low-level digital input current	$V_I = 0 \text{ V}$	-1			μA
C_i	Input capacitance			8		pF

ELECTRICAL CHARACTERISTICS

over recommended operating free-air temperature range, supply voltages, and reference voltages (unless otherwise noted)

ANALOG OUTPUT DYNAMIC PERFORMANCE							
PARAMETER		TEST CONDITIONS		MIN	TYP	MAX	UNIT
$t_{s(FS)}$	Output settling time (full scale)	$R_L = 10\text{ k}\Omega$, see note ⁽¹⁾	$C_L = 100\text{ pF}$,	Fast	1	3	μs
				Slow	3.5	7	
$t_{s(CC)}$	Output settling time, code to code	$R_L = 10\text{ k}\Omega$, see note ⁽²⁾	$C_L = 100\text{ pF}$,	Fast	0.5	1.5	μs
				Slow	1	2	
SR	Slew rate	$R_L = 10\text{ k}\Omega$, see note ⁽³⁾	$C_L = 100\text{ pF}$,	Fast	8		V/ μs
				Slow	1.5		
Glitch energy		DIN = 0 to 1, $\overline{CS} = V_{DD}$	$f_{out} = 1\text{ kHz}$,		5		nV-s
SNR	Signal-to-noise ratio			71	75		dB
S/(N+D)	Signal-to-noise + distortion			59	66		
THD	Total harmonic distortion	$f_s = 480\text{ kSPS}$, $R_L = 10\text{ k}\Omega$,	$f_{out} = 1\text{ kHz}$, $C_L = 100\text{ pF}$		-67	-59	
Spurious free dynamic range				59	69		

- (1) Settling time is the time for the output signal to remain within +0.5 LSB of the final measured value for a digital input code change of 0x20 to 0xFDF and 0xFDF to 0x020 respectively. Assured by design; not tested.
- (2) Settling time is the time for the output signal to remain within +0.5 LSB of the final measured value for a digital input code change of one count. Assured by design; not tested.
- (3) Slew rate determines the time it takes for a change of the DAC output from 10% to 90% full-scale voltage.

TIMING REQUIREMENTS

DIGITAL INPUTS					
		MIN	NOM	MAX	UNIT
$t_{su(CS-FS)}$	Setup time, \overline{CS} low before FS falling edge	10			ns
$t_{su(FS-CK)}$	Setup time, FS low before first negative SCLK edge	8			ns
$t_{su(C16-FS)}$	Setup time, 16 th negative edge after FS low on which bit D0 is sampled before rising edge of FS.	10			ns
$t_{su(C16-CS)}$	Setup time, 16 th positive SCLK edge (first positive after D0 is sampled) before \overline{CS} rising edge. If FS is used instead of 16 th positive edge to update DAC, then setup time between FS rising edge and \overline{CS} rising edge.	10			ns
t_{wH}	SCLK pulse duration high	25			ns
t_{wL}	SCLK pulse duration low	25			ns
$t_{su(D)}$	Setup time, data ready before SCLK falling edge	8			ns
$t_{h(D)}$	Hold time, data held valid after SCLK falling edge	5			ns
$t_{wH(FS)}$	FS duration high	25			ns

PARAMETER MEASUREMENT INFORMATION

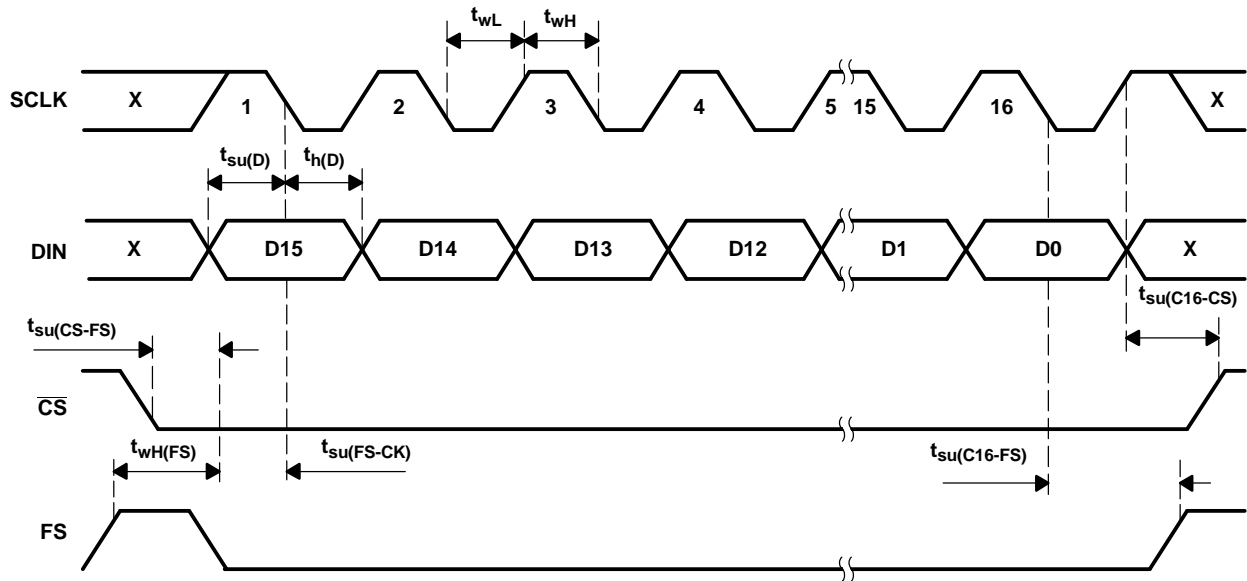
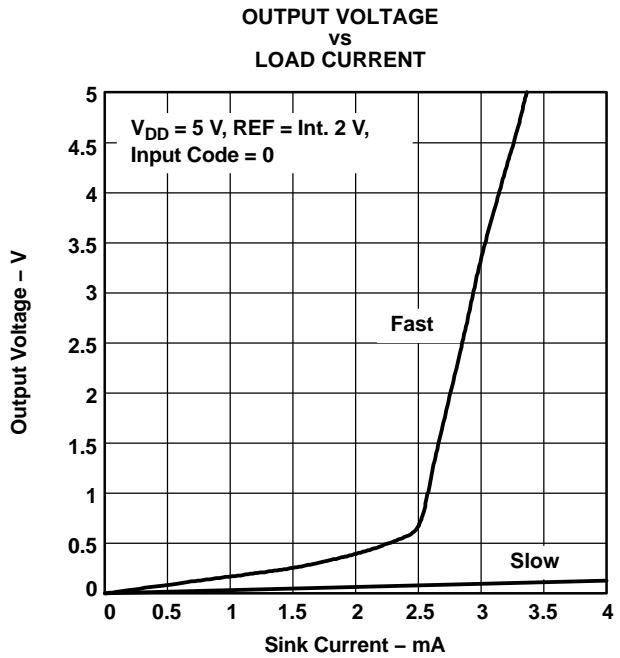
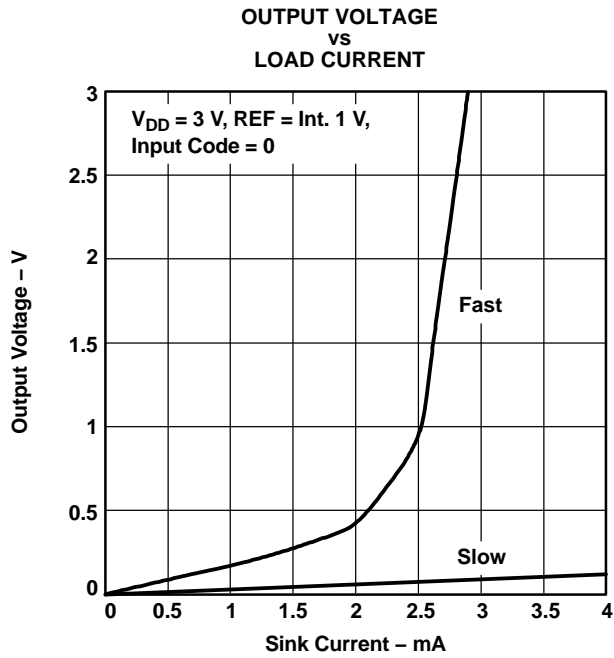
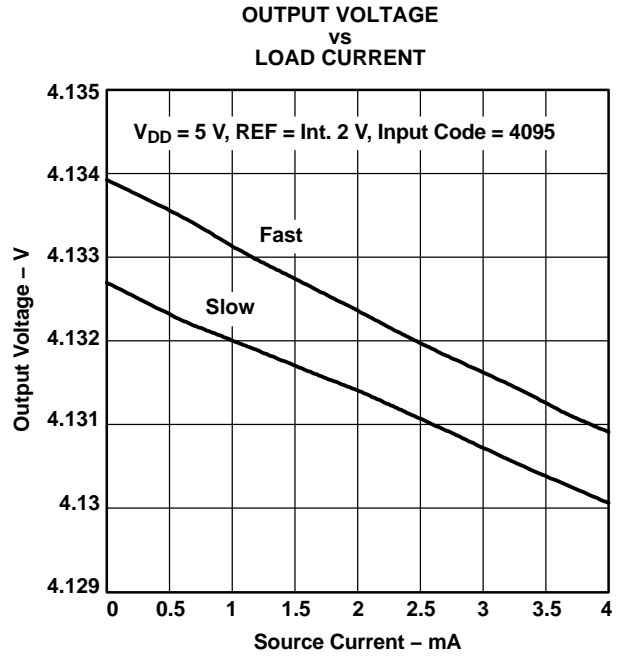
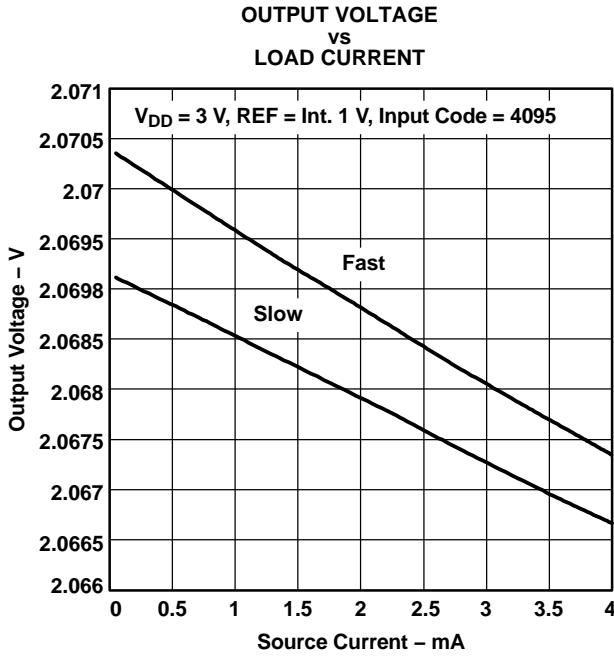

Figure 1. Timing Diagram

TYPICAL CHARACTERISTICS



TYPICAL CHARACTERISTICS (continued)

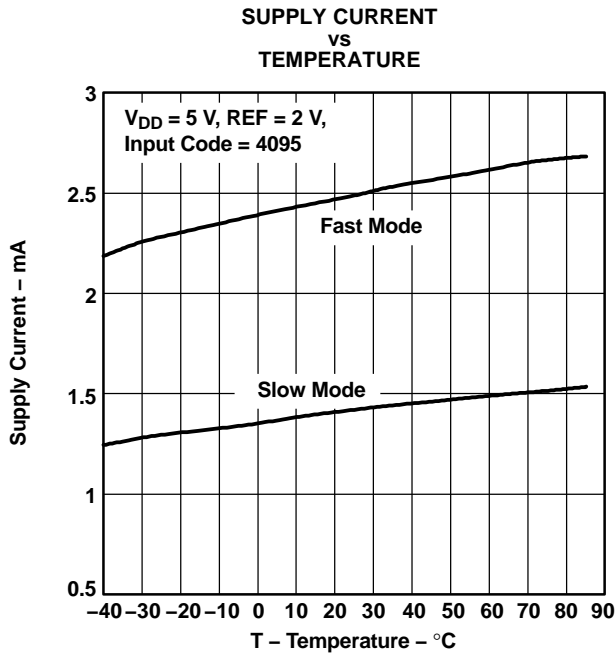

Figure 6.

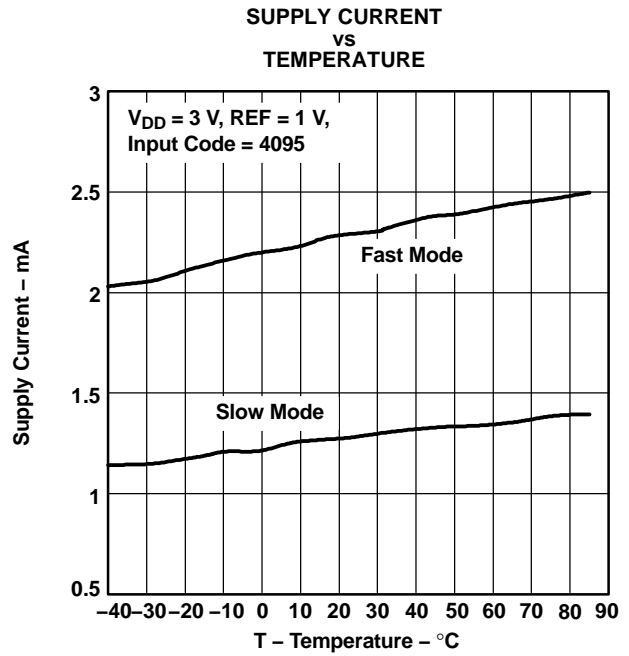

Figure 7.

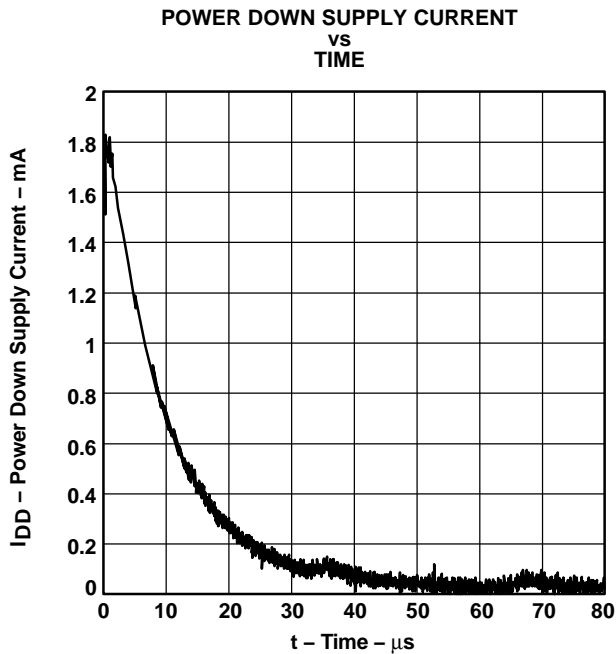

Figure 8.

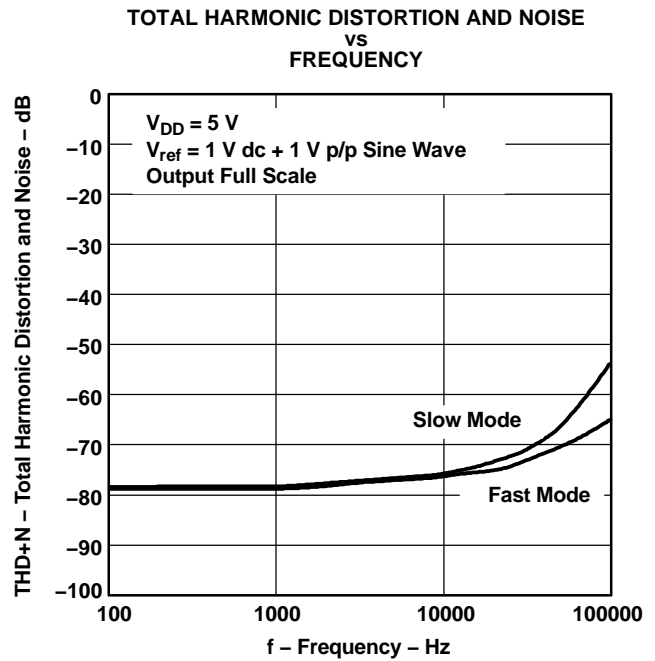
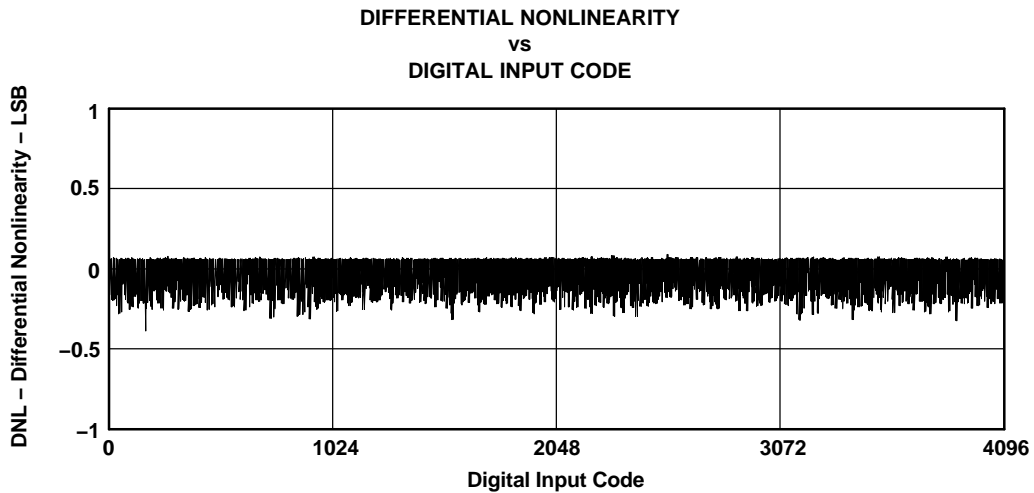
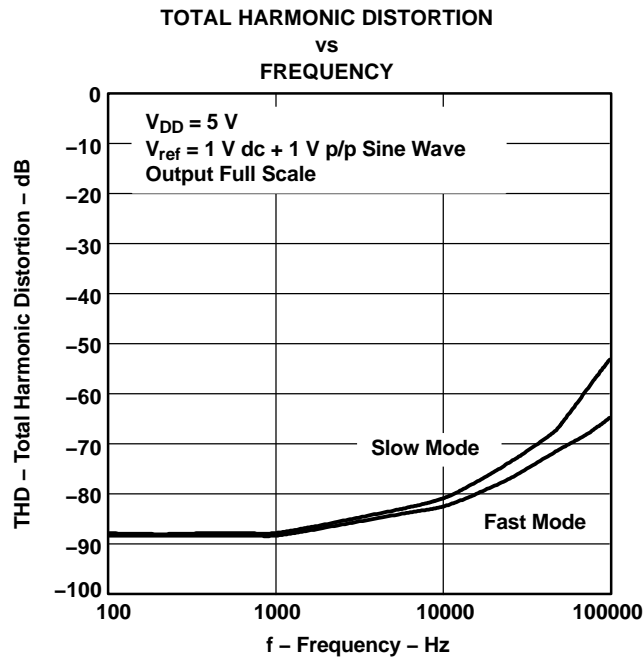

Figure 9.

TYPICAL CHARACTERISTICS (continued)



TYPICAL CHARACTERISTICS (continued)

**INTEGRAL NONLINEARITY
vs
DIGITAL INPUT CODE**

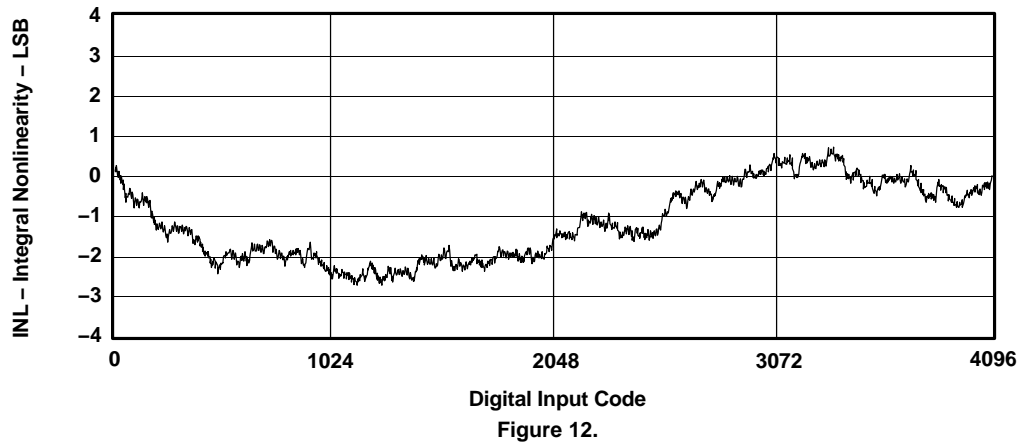

APPLICATION INFORMATION

GENERAL FUNCTION

The TLV5636 is a 12-bit, single supply DAC, based on a resistor string architecture. It consists of a serial interface, a speed and power-down control logic, a programmable internal reference, a resistor string, and a rail-to-rail output buffer.

The output voltage (full scale determined by external reference) for each channel is given by:

$$2 \text{ REF } \frac{\text{CODE}}{2^n} \text{ [V]}$$

where REF is the reference voltage and CODE is the digital input value within the range of 0_{10} to 2^{n-1} , where $n = 12$ (bits). The 16-bit data word, consisting of control bits and the new DAC value, is illustrated in the *data format* section. A power-on reset initially resets the internal latches to a defined state (all bits zero).

SERIAL INTERFACE

The device has to be enabled with $\overline{\text{CS}}$ set to low. A falling edge of FS starts shifting the data bit-per-bit (starting with the MSB) to the internal register on high-low transitions of SCLK. After 16 bits have been transferred or FS rises, the content of the shift register is moved to the DAC latch, which updates the voltage output to the new level.

The serial interface of the TLV5636 can be used in two basic modes:

- Four wire (with chip select)
- Three wire (without chip select)

Using chip select (four-wire mode), it is possible to have more than one device connected to the serial port of the data source (DSP or microcontroller). [Figure 13](#) shows an example with two TLV5636s connected directly to a TMS320 DSP.

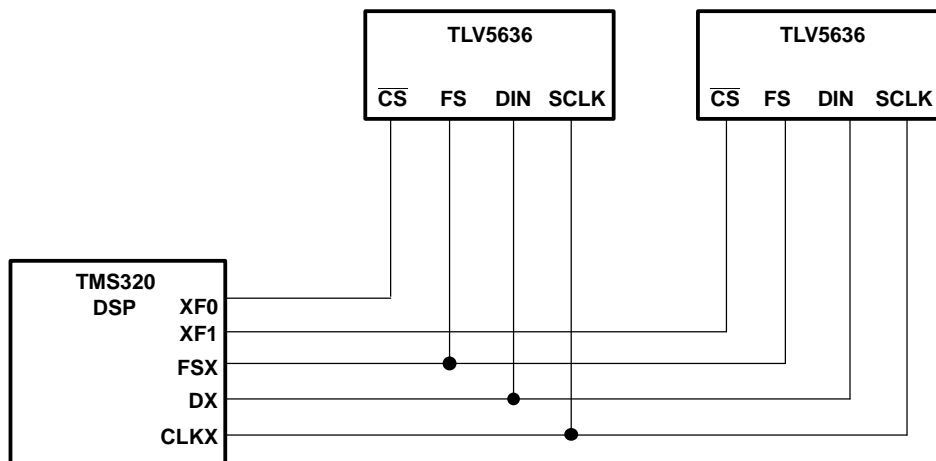

Figure 13. TMS320 Interface

If there is no need to have more than one device on the serial bus, then $\overline{\text{CS}}$ can be tied low. Figure 14 shows an example of how to connect the TLV5636 to TMS320, SPI™ or Microwire™ using only three pins.

APPLICATION INFORMATION (continued)

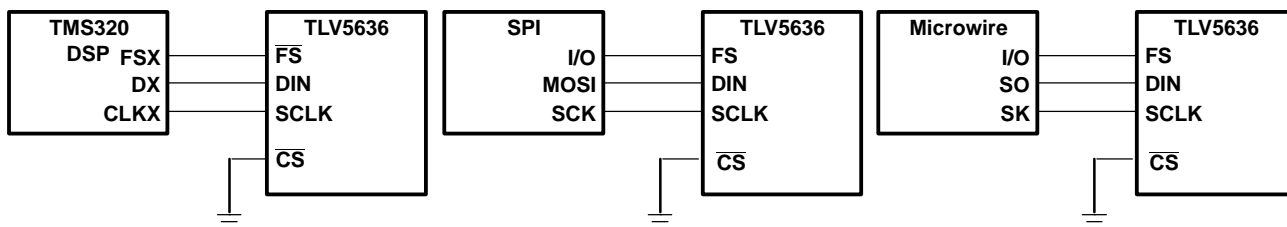

Figure 14. Three Wire Interface

Notes on SPI and Microwire: Before the controller starts the data transfer, the software has to generate a falling edge on the I/O pin connected to FS. If the word width is 8 bits (SPI and Microwire), two write operations must be performed to program the TLV5636. After the write operation(s), the DAC output is updated automatically on the next positive clock edge following the sixteenth falling clock edge.

SERIAL CLOCK AND UPDATE RATE

The maximum serial clock frequency is given by:

$$f_{sclmax} = \frac{1}{t_{whmin} + t_{wlmin}} = 20 \text{ MHz} \tag{1}$$

The maximum update rate is:

$$f_{updatemax} = \frac{1}{16(t_{whmin} + t_{wlmin})} = 1.25 \text{ MHz} \tag{2}$$

Note that the maximum update rate is just a theoretical value for the serial interface, as the settling time of the TLV5636 has to be considered, too.

DATA FORMAT

The 16-bit data word for the TLV5636 consists of two parts:

- Program bits (D15..D12)
- New data (D11..D0)

D15	D14	D13	D12	D11	D10	D9	D8	D7	D6	D5	D4	D3	D2	D1	D0
R1	SPD	PWR	R0	12 Data bits											

- SPD : Speed control bit 1 = fast mode 0 = slow mode
- PWR : Power control bit 1 = power down 0 = normal operation

The following table lists the possible combination of the register select bits:

Register Select Bits

R1	R0	REGISTER
0	0	Write data to DAC
0	1	Reserved
1	0	Reserved
1	1	Write data to control register

The meaning of the 12 data bits depends on the selected register. For the DAC register, the 12 data bits determine the new DAC output value:

Data Bits: DAC

D11	D10	D9	D8	D7	D6	D5	D4	D3	D2	D1	D0
New DAC value											

If the control register is selected, then D1, D0 of the 12 data bits are used to program the reference voltage:

Data Bits: CONTROL

D11	D10	D9	D8	D7	D6	D5	D4	D3	D2	D1	D0
X ⁽¹⁾	X	X	X	X	X	X	X	X	X	REF1	REF0

(1) X = don't care

REF1 and REF0 determine the reference source. If internal reference is selected, REF1 and REF0 determine the reference voltage.

Reference Bits

REF1	REF0	REFERENCE
0	0	External
0	1	1.024 V
1	0	2.048 V
1	1	External

CAUTION:

If external reference voltage is applied to the REF pin, external reference MUST be selected.

EXAMPLE:

- Set DAC output, select fast mode, select internal reference at 2.048 V:

Set reference voltage to 2.048 V (CONTROL register):

D15	D14	D13	D12	D11	D10	D9	D8	D7	D6	D5	D4	D3	D2	D1	D0
1	1	0	1	0	0	0	0	0	0	0	0	0	0	1	0

Write new DAC value and update DAC output:

D15	D14	D13	D12	D11	D10	D9	D8	D7	D6	D5	D4	D3	D2	D1	D0
0	1	0	0	New DAC output value											

The DAC output is updated on the rising clock edge after D0 is sampled.

To output data consecutively using the same DAC configuration, it is not necessary to program the CONTROL register again.

LINEARITY, OFFSET, AND GAIN ERROR USING SINGLE END SUPPLIES

When an amplifier is operated from a single supply, the voltage offset can still be either positive or negative. With a positive offset, the output voltage changes on the first code change. With a negative offset, the output voltage may not change with the first code, depending on the magnitude of the offset voltage.

The output amplifier attempts to drive the output to a negative voltage. However, because the most negative supply rail is ground, the output cannot drive below ground and clamps the output at 0 V.

The output voltage then remains at zero until the input code value produces a sufficient positive output voltage to overcome the negative offset voltage, resulting in the transfer function shown in [Figure 15](#).

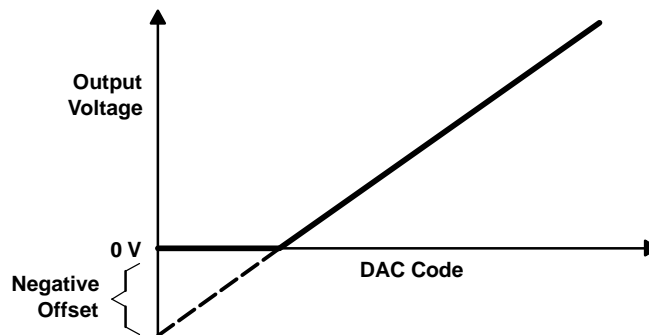

Figure 15. Effect of Negative Offset (Single Supply)

This offset error, not the linearity error, produces this breakpoint. The transfer function would have followed the dotted line if the output buffer could drive below the ground rail.

For a DAC, linearity is measured between zero-input code (all inputs 0) and full-scale code (all inputs 1) after offset and full scale are adjusted out or accounted for in some way. However, single supply operation does not allow for adjustment when the offset is negative due to the breakpoint in the transfer function. So the linearity is measured between full-scale code and the lowest code that produces a positive output voltage.

POWER-SUPPLY BYPASSING AND GROUND MANAGEMENT

Printed-circuit boards that use separate analog and digital ground planes offer the best system performance. Wire-wrap boards do not perform well and should not be used. The two ground planes should be connected together at the low-impedance power-supply source. The best ground connection may be achieved by connecting the DAC AGND terminal to the system analog ground plane, making sure that analog ground currents are well managed and there are negligible voltage drops across the ground plane.

A 0.1- μF ceramic-capacitor bypass should be connected between V_{DD} and AGND and mounted with short leads as close as possible to the device. Use of ferrite beads may further isolate the system analog supply from the digital power supply.

[Figure 16](#) shows the ground plane layout and bypassing technique.

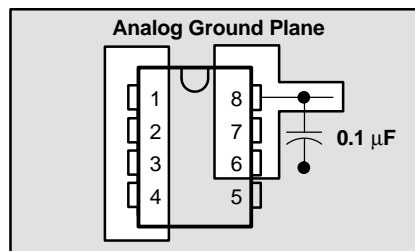

Figure 16. Power-Supply Bypassing

DEFINITIONS OF SPECIFICATIONS AND TERMINOLOGY

Integral Nonlinearity (INL)

The relative accuracy or integral nonlinearity (INL), sometimes referred to as linearity error, is the maximum deviation of the output from the line between zero and full scale excluding the effects of zero code and full-scale errors.

Differential Nonlinearity (DNL)

The differential nonlinearity (DNL), sometimes referred to as differential error, is the difference between the measured and ideal 1 LSB amplitude change of any two adjacent codes. Monotonic means the output voltage changes in the same direction (or remains constant) as a change in the digital input code.

Zero-Scale Error (E_{ZS})

Zero-scale error is defined as the deviation of the output from 0 V at a digital input value of 0.

Gain Error (E_G)

Gain error is the error in slope of the DAC transfer function.

Total Harmonic Distortion (THD)

THD is the ratio of the rms value of the first six harmonic components to the value of the fundamental signal. The value for THD is expressed in decibels.

Signal-To-Noise Ratio + Distortion (S/N+D)

S/N+D is the ratio of the rms value of the output signal to the rms sum of all other spectral components below the Nyquist frequency, including harmonics but excluding dc. The value for S/N+D is expressed in decibels.

Spurious Free Dynamic Range (SFDR)

Spurious free dynamic range is the difference between the rms value of the output signal and the rms value of the largest spurious signal within a specified bandwidth. The value for SFDR is expressed in decibels.

PACKAGING INFORMATION

Orderable Device	Status (1)	Package Type	Package Drawing	Pins	Package Qty	Eco Plan (2)	Lead finish/ Ball material (6)	MSL Peak Temp (3)	Op Temp (°C)	Device Marking (4/5)	Samples
TLV5636CD	ACTIVE	SOIC	D	8	75	RoHS & Green	NIPDAU	Level-1-260C-UNLIM	0 to 70	5636C	Samples
TLV5636CDGK	ACTIVE	VSSOP	DGK	8	80	RoHS & Green	NIPDAUAG	Level-1-260C-UNLIM	0 to 70	AJF	Samples
TLV5636CDGKR	ACTIVE	VSSOP	DGK	8	2500	RoHS & Green	NIPDAUAG	Level-1-260C-UNLIM	0 to 70	AJF	Samples
TLV5636ID	ACTIVE	SOIC	D	8	75	RoHS & Green	NIPDAU	Level-1-260C-UNLIM	-40 to 85	5636I	Samples
TLV5636IDGK	ACTIVE	VSSOP	DGK	8	80	RoHS & Green	NIPDAUAG	Level-1-260C-UNLIM	-40 to 85	AJG	Samples
TLV5636IDGKR	ACTIVE	VSSOP	DGK	8	2500	RoHS & Green	NIPDAUAG	Level-1-260C-UNLIM	-40 to 85	AJG	Samples
TLV5636IDR	ACTIVE	SOIC	D	8	2500	RoHS & Green	NIPDAU	Level-1-260C-UNLIM	-40 to 85	5636I	Samples

(1) The marketing status values are defined as follows:

ACTIVE: Product device recommended for new designs.

LIFEBUY: TI has announced that the device will be discontinued, and a lifetime-buy period is in effect.

NRND: Not recommended for new designs. Device is in production to support existing customers, but TI does not recommend using this part in a new design.

PREVIEW: Device has been announced but is not in production. Samples may or may not be available.

OBSOLETE: TI has discontinued the production of the device.

(2) **RoHS:** TI defines "RoHS" to mean semiconductor products that are compliant with the current EU RoHS requirements for all 10 RoHS substances, including the requirement that RoHS substance do not exceed 0.1% by weight in homogeneous materials. Where designed to be soldered at high temperatures, "RoHS" products are suitable for use in specified lead-free processes. TI may reference these types of products as "Pb-Free".

RoHS Exempt: TI defines "RoHS Exempt" to mean products that contain lead but are compliant with EU RoHS pursuant to a specific EU RoHS exemption.

Green: TI defines "Green" to mean the content of Chlorine (Cl) and Bromine (Br) based flame retardants meet JS709B low halogen requirements of <=1000ppm threshold. Antimony trioxide based flame retardants must also meet the <=1000ppm threshold requirement.

(3) MSL, Peak Temp. - The Moisture Sensitivity Level rating according to the JEDEC industry standard classifications, and peak solder temperature.

(4) There may be additional marking, which relates to the logo, the lot trace code information, or the environmental category on the device.

(5) Multiple Device Markings will be inside parentheses. Only one Device Marking contained in parentheses and separated by a "~" will appear on a device. If a line is indented then it is a continuation of the previous line and the two combined represent the entire Device Marking for that device.

⁽⁶⁾ Lead finish/Ball material - Orderable Devices may have multiple material finish options. Finish options are separated by a vertical ruled line. Lead finish/Ball material values may wrap to two lines if the finish value exceeds the maximum column width.

Important Information and Disclaimer:The information provided on this page represents TI's knowledge and belief as of the date that it is provided. TI bases its knowledge and belief on information provided by third parties, and makes no representation or warranty as to the accuracy of such information. Efforts are underway to better integrate information from third parties. TI has taken and continues to take reasonable steps to provide representative and accurate information but may not have conducted destructive testing or chemical analysis on incoming materials and chemicals. TI and TI suppliers consider certain information to be proprietary, and thus CAS numbers and other limited information may not be available for release.

In no event shall TI's liability arising out of such information exceed the total purchase price of the TI part(s) at issue in this document sold by TI to Customer on an annual basis.

TAPE AND REEL INFORMATION

QUADRANT ASSIGNMENTS FOR PIN 1 ORIENTATION IN TAPE

*All dimensions are nominal

Device	Package Type	Package Drawing	Pins	SPQ	Reel Diameter (mm)	Reel Width W1 (mm)	A0 (mm)	B0 (mm)	K0 (mm)	P1 (mm)	W (mm)	Pin1 Quadrant
TLV5636CDGKR	VSSOP	DGK	8	2500	330.0	12.4	5.3	3.4	1.4	8.0	12.0	Q1
TLV5636IDGKR	VSSOP	DGK	8	2500	330.0	12.4	5.3	3.4	1.4	8.0	12.0	Q1
TLV5636IDR	SOIC	D	8	2500	330.0	12.4	6.4	5.2	2.1	8.0	12.0	Q1

TAPE AND REEL BOX DIMENSIONS

*All dimensions are nominal

Device	Package Type	Package Drawing	Pins	SPQ	Length (mm)	Width (mm)	Height (mm)
TLV5636CDGKR	VSSOP	DGK	8	2500	350.0	350.0	43.0
TLV5636IDGKR	VSSOP	DGK	8	2500	350.0	350.0	43.0
TLV5636IDR	SOIC	D	8	2500	350.0	350.0	43.0

TUBE

*All dimensions are nominal

Device	Package Name	Package Type	Pins	SPQ	L (mm)	W (mm)	T (μm)	B (mm)
TLV5636CD	D	SOIC	8	75	505.46	6.76	3810	4
TLV5636CDGK	DGK	VSSOP	8	80	331.47	6.55	3000	2.88
TLV5636ID	D	SOIC	8	75	505.46	6.76	3810	4
TLV5636IDGK	DGK	VSSOP	8	80	331.47	6.55	3000	2.88

DGK0008A

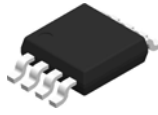

PACKAGE OUTLINE

VSSOP - 1.1 mm max height

SMALL OUTLINE PACKAGE



4214862/A 04/2023

NOTES:

PowerPAD is a trademark of Texas Instruments.

1. All linear dimensions are in millimeters. Any dimensions in parenthesis are for reference only. Dimensioning and tolerancing per ASME Y14.5M.
2. This drawing is subject to change without notice.
3. This dimension does not include mold flash, protrusions, or gate burrs. Mold flash, protrusions, or gate burrs shall not exceed 0.15 mm per side.
4. This dimension does not include interlead flash. Interlead flash shall not exceed 0.25 mm per side.
5. Reference JEDEC registration MO-187.

EXAMPLE BOARD LAYOUT

DGK0008A

™ VSSOP - 1.1 mm max height

SMALL OUTLINE PACKAGE



LAND PATTERN EXAMPLE
EXPOSED METAL SHOWN
SCALE: 15X

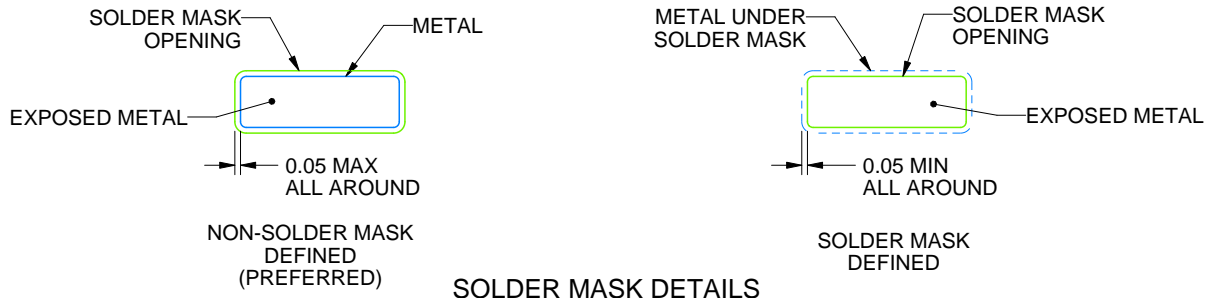

SOLDER MASK DETAILS

4214862/A 04/2023

NOTES: (continued)

6. Publication IPC-7351 may have alternate designs.
7. Solder mask tolerances between and around signal pads can vary based on board fabrication site.
8. Vias are optional depending on application, refer to device data sheet. If any vias are implemented, refer to their locations shown on this view. It is recommended that vias under paste be filled, plugged or tented.
9. Size of metal pad may vary due to creepage requirement.

EXAMPLE STENCIL DESIGN

DGK0008A

™ VSSOP - 1.1 mm max height

SMALL OUTLINE PACKAGE



SOLDER PASTE EXAMPLE
SCALE: 15X

4214862/A 04/2023

NOTES: (continued)

11. Laser cutting apertures with trapezoidal walls and rounded corners may offer better paste release. IPC-7525 may have alternate design recommendations.
12. Board assembly site may have different recommendations for stencil design.



D0008A

PACKAGE OUTLINE

SOIC - 1.75 mm max height

SMALL OUTLINE INTEGRATED CIRCUIT



4214825/C 02/2019

NOTES:

1. Linear dimensions are in inches [millimeters]. Dimensions in parenthesis are for reference only. Controlling dimensions are in inches. Dimensioning and tolerancing per ASME Y14.5M.
2. This drawing is subject to change without notice.
3. This dimension does not include mold flash, protrusions, or gate burrs. Mold flash, protrusions, or gate burrs shall not exceed $.006$ [0.15] per side.
4. This dimension does not include interlead flash.
5. Reference JEDEC registration MS-012, variation AA.

EXAMPLE BOARD LAYOUT

D0008A

SOIC - 1.75 mm max height

SMALL OUTLINE INTEGRATED CIRCUIT



LAND PATTERN EXAMPLE
EXPOSED METAL SHOWN
SCALE:8X



SOLDER MASK DETAILS

4214825/C 02/2019

NOTES: (continued)

- 6. Publication IPC-7351 may have alternate designs.
- 7. Solder mask tolerances between and around signal pads can vary based on board fabrication site.

EXAMPLE STENCIL DESIGN

D0008A

SOIC - 1.75 mm max height

SMALL OUTLINE INTEGRATED CIRCUIT



SOLDER PASTE EXAMPLE
BASED ON .005 INCH [0.125 MM] THICK STENCIL
SCALE:8X

4214825/C 02/2019

NOTES: (continued)

8. Laser cutting apertures with trapezoidal walls and rounded corners may offer better paste release. IPC-7525 may have alternate design recommendations.
9. Board assembly site may have different recommendations for stencil design.

IMPORTANT NOTICE AND DISCLAIMER

TI PROVIDES TECHNICAL AND RELIABILITY DATA (INCLUDING DATA SHEETS), DESIGN RESOURCES (INCLUDING REFERENCE DESIGNS), APPLICATION OR OTHER DESIGN ADVICE, WEB TOOLS, SAFETY INFORMATION, AND OTHER RESOURCES "AS IS" AND WITH ALL FAULTS, AND DISCLAIMS ALL WARRANTIES, EXPRESS AND IMPLIED, INCLUDING WITHOUT LIMITATION ANY IMPLIED WARRANTIES OF MERCHANTABILITY, FITNESS FOR A PARTICULAR PURPOSE OR NON-INFRINGEMENT OF THIRD PARTY INTELLECTUAL PROPERTY RIGHTS.

These resources are intended for skilled developers designing with TI products. You are solely responsible for (1) selecting the appropriate TI products for your application, (2) designing, validating and testing your application, and (3) ensuring your application meets applicable standards, and any other safety, security, regulatory or other requirements.

These resources are subject to change without notice. TI grants you permission to use these resources only for development of an application that uses the TI products described in the resource. Other reproduction and display of these resources is prohibited. No license is granted to any other TI intellectual property right or to any third party intellectual property right. TI disclaims responsibility for, and you will fully indemnify TI and its representatives against, any claims, damages, costs, losses, and liabilities arising out of your use of these resources.

TI's products are provided subject to [TI's Terms of Sale](#) or other applicable terms available either on [ti.com](https://www.ti.com) or provided in conjunction with such TI products. TI's provision of these resources does not expand or otherwise alter TI's applicable warranties or warranty disclaimers for TI products.

TI objects to and rejects any additional or different terms you may have proposed.

Mailing Address: Texas Instruments, Post Office Box 655303, Dallas, Texas 75265
Copyright © 2024, Texas Instruments Incorporated

Looking for pricing, stock, or lifecycle information?

Click below to explore more details on WIN SOURCE:

 [View TLV5636IDR on WIN SOURCE](#)

 [Texas Instruments](#) Information

Optimize Your Supply Chain with WIN SOURCE Solutions

-  Global Sourcing Solution
-  Obsolete Management
-  Cost Control Management
-  Shortage Management
-  Alternative Solution
-  Excess Inventory Management