

TOSHIBA Photocoupler IRED & Photo-Transistor

TLP785, TLP785F

Office Equipment
Home Electric Appliances
Solid-State Relays
Switching Power Supplies
Contactless Controller Outputs
Simplex/Multiplex Data Transmission

The TOSHIBA TLP785 consists of a silicone phototransistor optically coupled to an infrared emitting diode in a four lead plastic DIP (DIP4) with having high isolation voltage (AC: 5000 Vrms (min)).
TLP785F is a lead forming type for the long creepage surface mounting of TLP785.

- TLP785: 7.62 mm pitch type DIP4
- TLP785F: 10.16 mm pitch type DIP4
- Collector-emitter voltage: 80 V (min)
- Current transfer ratio: 50% (min)
Rank GB: 100% (min)
- Isolation voltage: 5000 Vrms (min)
- UL-recognized : UL 1577, File No.E67349
- cUL-recognized :CSA Component Acceptance Service No.5A
File No.E67349
- VDE-approved : EN 60747-5-5 (Note 1)
- CQC-approved: GB4943.1, GB8898 China Factory
- SEMKO-approved : EN 62368-1

Note 1 : When a VDE approved type is needed, please designate the **Option(D4)**.

- Construction mechanical rating

	7.62 mm Pitch Standard Type	10.16 mm Pitch TLPxxxF Type
Creepage distance	7.0 mm (min)	8.0 mm (min)
Clearance	7.0 mm (min)	8.0 mm (min)
Insulation thickness	0.4 mm (min)	0.4 mm (min)
Inner creepage distance	4.0 mm (min)	4.0 mm (min)

TLP785

Unit: mm

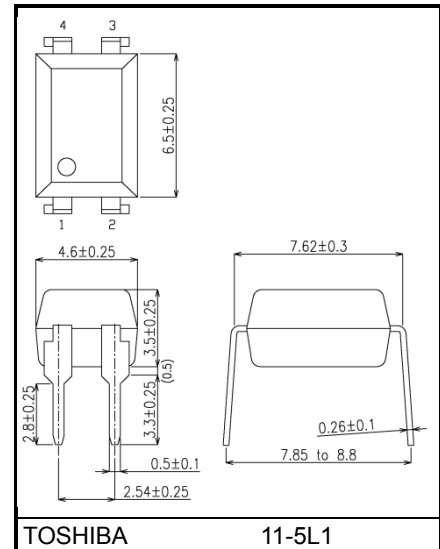

Weight: 0.25 g (typ.)

TLP785F

Unit: mm

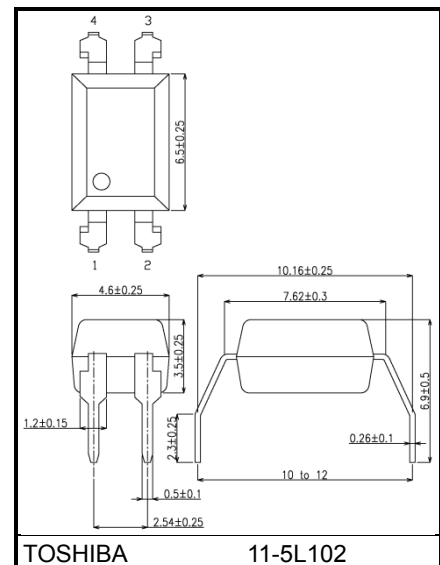

Weight: 0.25 g (typ.)

Pin Configurations (top view)

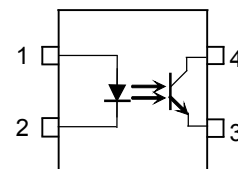

- 1 : Anode
- 2 : Cathode
- 3 : Emitter
- 4 : Collector

Start of commercial production
2010-11

Current Transfer Ratio (Note)

Type	Classification (Note 1)	Current Transfer Ratio (%) (I_C / I_F)		Marking of Classification
		$I_F = 5\text{mA}, V_{CE} = 5\text{V}, T_a = 25^\circ\text{C}$		
		Min	Max	
TLP785	None	50	600	Blank
	Rank Y	50	150	YE
	Rank GR	100	300	GR
	Rank BL	200	600	BL
	Rank GB	100	600	GB
	Rank YH	75	150	Y+
	Rank GRL	100	200	G
	Rank GRH	150	300	G+
	Rank BLL	200	400	B

Note 1: e.g. rank GB: TLP785 (GB)

Note: Application type name for certification (IC test), please use standard product type name, e.g. TLP785 (GB): TLP785

Absolute Maximum Ratings (Note) ($T_a = 25^\circ\text{C}$)

Characteristics		Symbol	Rating	Unit
LED	Forward current	I_F	60	mA
	Forward current derating ($T_a \geq 39^\circ\text{C}$)	$\Delta I_F / ^\circ\text{C}$	-0.7	mA / $^\circ\text{C}$
	Pulse forward current (Note 2)	I_{FP}	1	A
	Power dissipation	P_D	90	mW
	Power dissipation derating ($T_a \geq 39^\circ\text{C}$)	$\Delta P_D / ^\circ\text{C}$	-0.9	mW / $^\circ\text{C}$
	Reverse voltage	V_R	5	V
	Junction temperature	T_j	125	$^\circ\text{C}$
Detector	Collector-emitter voltage	V_{CEO}	80	V
	Emitter-collector voltage	V_{ECO}	7	V
	Collector current	I_C	50	mA
	Power dissipation (single circuit)	P_C	150	mW
	Power dissipation derating ($T_a \geq 25^\circ\text{C}$)	$\Delta P_C / ^\circ\text{C}$	-1.5	mW / $^\circ\text{C}$
	Junction temperature	T_j	125	$^\circ\text{C}$
Operating temperature range		T_{opr}	-55 to 110	$^\circ\text{C}$
Storage temperature range		T_{stg}	-55 to 125	$^\circ\text{C}$
Lead soldering temperature (10 s)		T_{sol}	260	$^\circ\text{C}$
Total package power dissipation		P_T	240	mW
Total package power dissipation derating ($T_a \geq 25^\circ\text{C}$)		$\Delta P_T / ^\circ\text{C}$	-2.4	mW / $^\circ\text{C}$
Isolation voltage (Note 3)		BV_S	5000	V_{rms}

Note: Using continuously under heavy loads (e.g. the application of high temperature/current/voltage and the significant change in temperature, etc.) may cause this product to decrease in the reliability significantly even if the operating conditions (i.e. operating temperature/current/voltage, etc.) are within the absolute maximum ratings.

Please design the appropriate reliability upon reviewing the Toshiba Semiconductor Reliability Handbook ("Handling Precautions"/"Derating Concept and Methods") and individual reliability data (i.e. reliability test report and estimated failure rate, etc.).

Note 2: Pulse Width: 100 μs or less, 100 Hz frequency

Note 3: AC, 60 s., R.H. $\leq 60\%$. Apply voltage to LED pin and detector pin together.

Recommended Operating Conditions (Note)

Characteristics	Symbol	Min	Typ.	Max	Unit
Supply voltage	V_{CC}	—	5	24	V
Forward current	I_F	—	16	25	mA
Collector current	I_C	—	1	10	mA
Operating temperature	T_{opr}	-25	—	85	°C

Note: Recommended operating conditions are given as a design guideline to obtain expected performance of the device. Additionally, each item is an independent guideline respectively. In developing designs using this product, please confirm specified characteristics shown in this document.

Individual Electrical Characteristics (Ta = 25°C)

Characteristics		Symbol	Test Condition	Min	Typ.	Max	Unit
LED	Forward voltage	V_F	$I_F = 10 \text{ mA}$	1.0	1.15	1.3	V
	Reverse current	I_R	$V_R = 5 \text{ V}$	—	—	10	μA
	Capacitance	C_T	$V = 0 \text{ V}, f = 1 \text{ MHz}$	—	30	—	pF
Detector	Collector-emitter breakdown voltage	$V_{(BR) CEO}$	$I_C = 0.5 \text{ mA}$	80	—	—	V
	Emitter-collector breakdown voltage	$V_{(BR) ECO}$	$I_E = 0.1 \text{ mA}$	7	—	—	V
	Collector dark current	$I_D(I_{CEO})$	$V_{CE} = 24 \text{ V}$	—	0.01	0.1	μA
			$V_{CE} = 24 \text{ V}, T_a = 85 \text{ °C}$	—	0.6	50	μA
Capacitance (collector to emitter)	C_{CE}	$V = 0 \text{ V}, f = 1 \text{ MHz}$	—	6	—	pF	

Coupled Electrical Characteristics (Ta = 25°C)

Characteristics	Symbol	Test Condition	Min	Typ.	Max	Unit
Current transfer ratio	I_C / I_F	$I_F = 5 \text{ mA}, V_{CE} = 5 \text{ V}$	50	—	600	%
			Rank GB	100	—	
Saturated CTR	$I_C / I_F (\text{sat})$	$I_F = 1 \text{ mA}, V_{CE} = 0.4 \text{ V}$	—	60	—	%
			Rank GB	30	—	
Collector-emitter saturation voltage	$V_{CE} (\text{sat})$	$I_C = 2.4 \text{ mA}, I_F = 8 \text{ mA}$	—	—	0.4	V
			Rank GB	—	0.2	
		$I_C = 0.2 \text{ mA}, I_F = 1 \text{ mA}$	—	—	0.4	

Isolation Characteristics (Ta = 25°C)

Characteristics	Symbol	Test Condition	Min	Typ.	Max	Unit
Capacitance (input to output)	C_S	$V_S = 0 \text{ V}, f = 1 \text{ MHz}$	—	0.8	—	pF
Isolation resistance	R_S	$V_S = 500 \text{ V}, \text{R.H.} \leq 60 \%$	1×10^{12}	10^{14}	—	Ω
Isolation voltage	BV_S	AC, 60 s	5000	—	—	V_{rms}

Switching Characteristics (Ta = 25°C)

Characteristics	Symbol	Test Condition	Min	Typ.	Max	Unit
Rise time	t_r	$V_{CC} = 10\text{ V}$, $I_C = 2\text{ mA}$ $R_L = 100\ \Omega$	—	2	—	μs
Fall time	t_f		—	3	—	
Turn-on time	t_{on}		—	3	—	
Turn-off time	t_{off}		—	3	—	
Turn-on time	t_{on}	$R_L = 1.9\text{ k}\Omega$ (fig. 1) $V_{CC} = 5\text{ V}$, $I_F = 16\text{ mA}$	—	1.5	—	μs
Storage time	t_s		—	25	—	
Turn-off time	t_{off}		—	50	—	

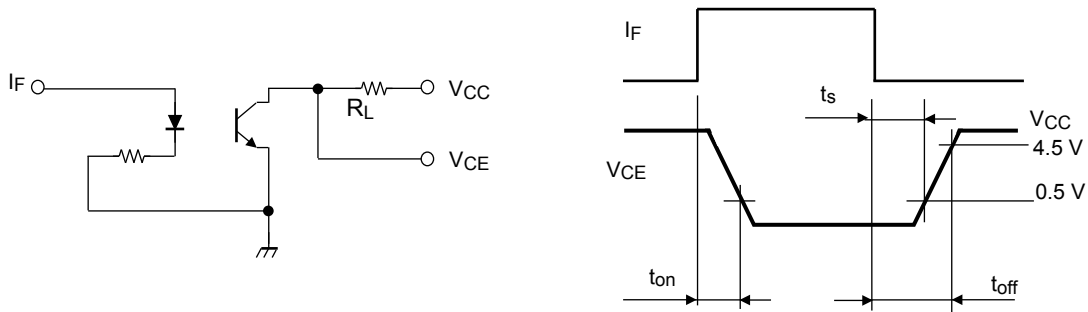
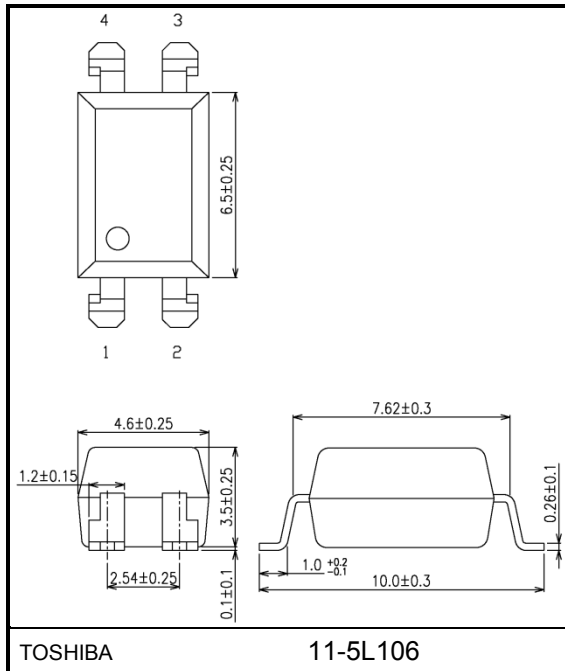

fig. 1: Switching time test circuit

Surface-Mount Lead Form Option

TLP785(LF6)

Unit: mm



Weight: 0.24 g (typ.)

TLP785F(LF7)

Unit: mm

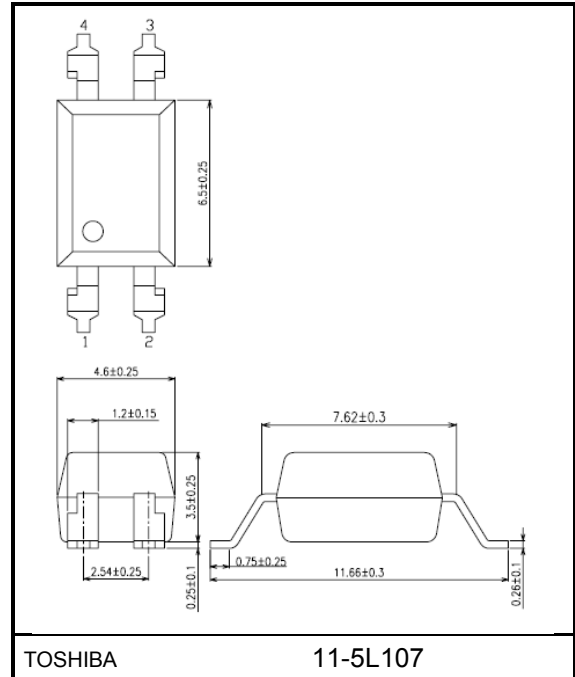

Weight: 0.25 g (typ.)

Option: Specifications for Embossed-Tape Packing; (TP6) / (TP7)

1. Applicable Package

Package Name	Product Type
DIP4LF6	TLP785
DIP4LF7	TLP785F

2. Product Naming System

Type of package used for shipment is denoted by a symbol suffix after a product number. The method of classification is as below.

(Example1)

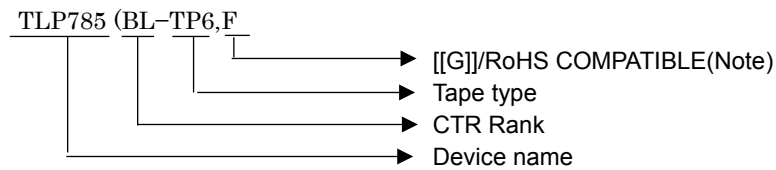

(Example2)

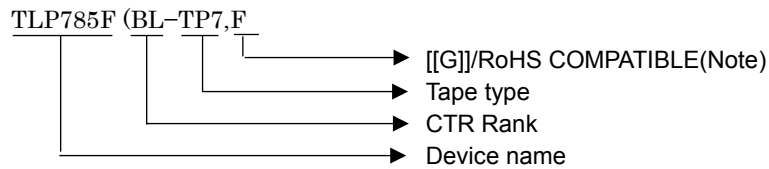

Note: Please contact your Toshiba sales representative for details on environmental information such as the product's RoHS compatibility.

RoHS is the Directive 2011/65/EU of the European Parliament and of the Council of 8 June 2011 on the restriction of the use of certain hazardous substances in electrical and electronics equipment.

3. Tape Dimensions

3.1 Orientation of Device in Relation to Direction of Tape Movement

Device orientation in the recesses is as shown in Figure 2.

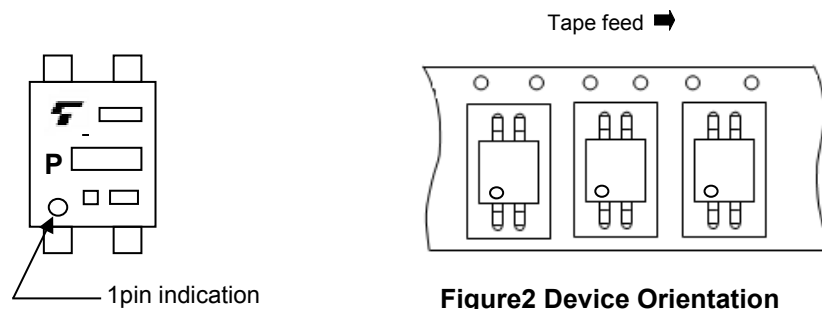

3.2 Tape Packing Quantity: 2000 devices per reel

3.3 Empty Device Recesses Are as Shown in Table 1.

Table 1 Empty Device Recesses

	Standard	Remarks
Occurrences of 2 or more successive empty device recesses	0 device	Within any given 40mm section of tape, not including leader and trailer
Single empty device recesses	6 devices (max) per reel	Not including leader and trailer

3.4 Start and End of Tape

The start of the tape has 30 or more empty holes. The end of the tape has 50 or more empty holes.

3.5 Tape Specification

[1] TLP785(TP6) / TLP785F(TP7)

- Tape material: Synthetic Resin
- Dimensions: The tape dimensions are as shown in Figure 3.

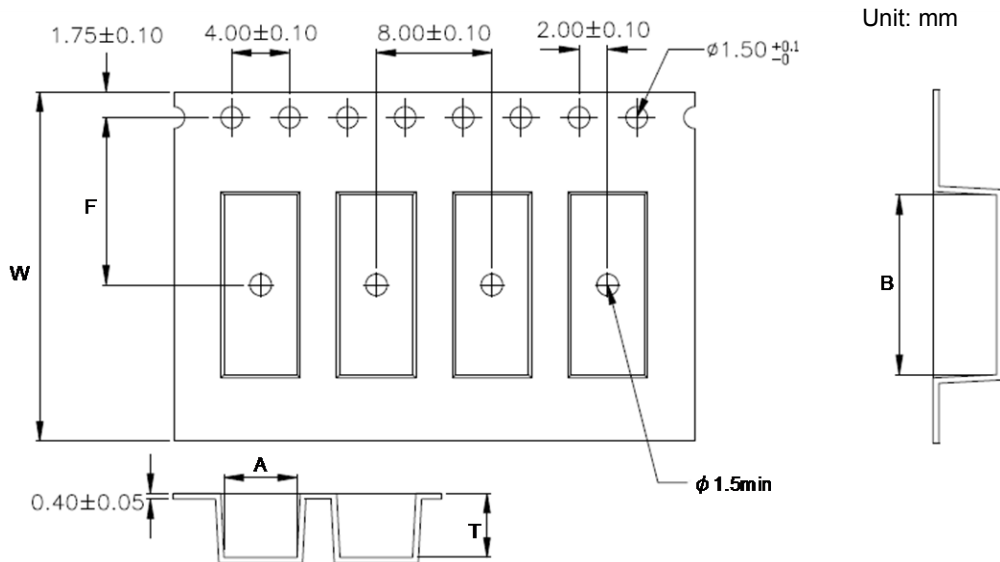

Figure 3 Tape Forms

	TP6 Type	TP7 Type
A	5.1±0.1	5.05±0.1
B	10.6±0.1	12.35±0.1
W	16.0±0.3	24.0±0.3
F	7.5±0.1	11.5±0.1
T	4.2±0.15	4.4±0.1

3.6 Reel Specification

[1] TLP785(TP6) / TLP785F(TP7)

- Material: Synthetic Resin
- Dimensions: The reel dimensions are as shown in Figure 4.

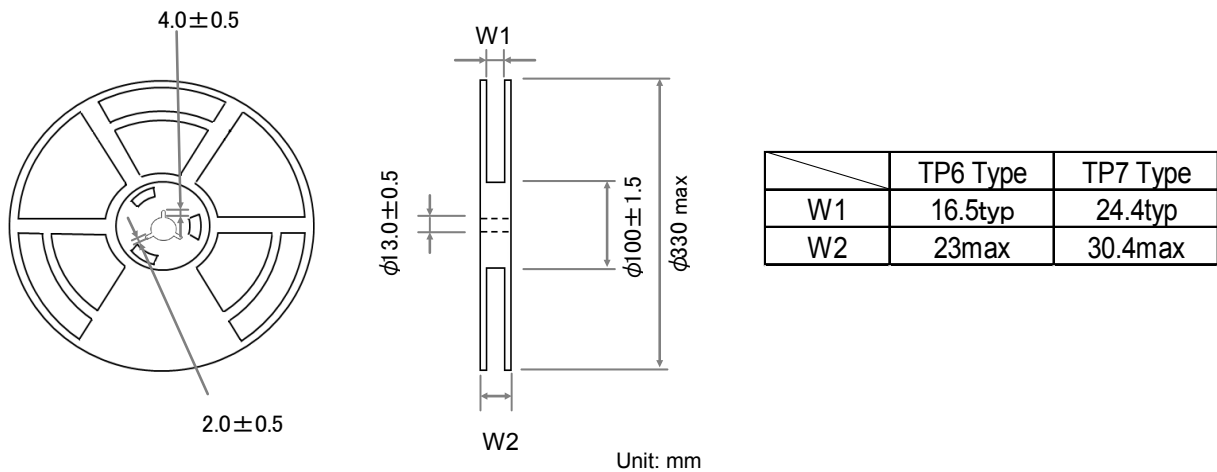

Figure 4 Reel Forms

4. Packing

Two reels of photocouplers are packed in a shipping carton.

5. Label Indication

The carton bears a label indicating the product number, the symbol representing classification of standard, the quantity, the lot number and the Toshiba company name.

6. Ordering Information

When placing an order, please specify the product number, the CTR rank, the tape type and the quantity as shown in the following example.

(Example)

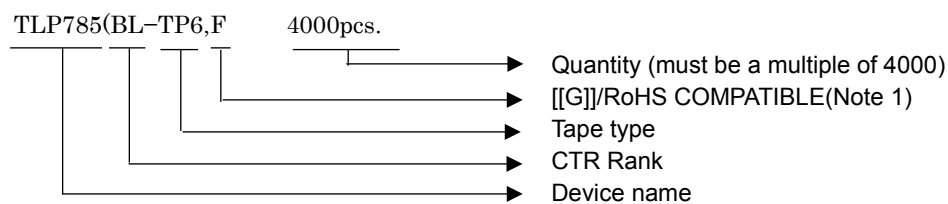

Note: The order code may be suffixed with a letter or a digit.

Please contact your nearest Toshiba sales representative for more details.

Note 1: Please contact your Toshiba sales representative for details on environmental information such as the product's RoHS compatibility.

RoHS is the Directive 2011/65/EU of the European Parliament and of the Council of 8 June 2011 on the restriction of the use of certain hazardous substances in electrical and electronics equipment.

7. Soldering and Storage

7.1. Precautions for Soldering

The soldering temperature should be controlled as closely as possible to the conditions shown below, irrespective of whether a soldering iron or a reflow soldering method is used.

- When using soldering reflow
 - The soldering temperature profile is based on the package surface temperature. (See the figure shown below, which is based on the package surface temperature.)
 - Reflow soldering must be performed once or twice.
 - The mounting should be completed with the interval from the first to the last mountings being 2 weeks.

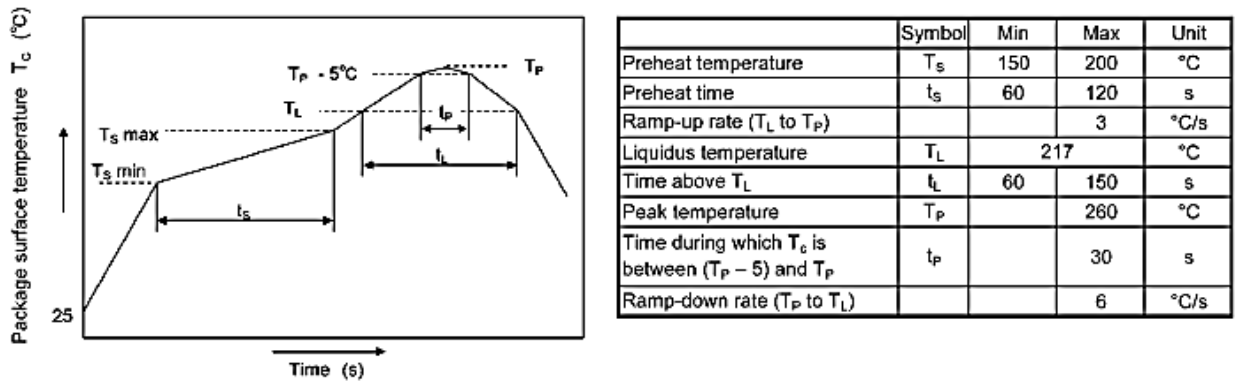



Fig. 7.1 An Example of a Temperature Profile When Lead(Pb)-Free Solder Is Used

- When using soldering flow
 - Preheat the device at a temperature of 150 °C (package surface temperature) for 60 to 120 seconds.
 - Mounting condition of 260 °C within 10 seconds is recommended.
 - Flow soldering must be performed once.
- When using soldering Iron
 - Complete soldering within 10 seconds for lead temperature not exceeding 260 °C or within 3 seconds not exceeding 350 °C
 - Heating by soldering iron must be done only once per lead.

7.2. Precautions for General Storage

- Avoid storage locations where devices may be exposed to moisture or direct sunlight.
- Follow the precautions printed on the packing label of the device for transportation and storage.
- Keep the storage location temperature and humidity within a range of 5°C to 35°C and 45% to 75%, respectively.
- Do not store the products in locations with poisonous gases (especially corrosive gases) or in dusty conditions.
- Store the products in locations with minimal temperature fluctuations. Rapid temperature changes during storage can cause condensation, resulting in lead oxidation or corrosion, which will deteriorate the solderability of the leads.
- When restoring devices after removal from their packing, use anti-static containers.
- Do not allow loads to be applied directly to devices while they are in storage.
- If devices have been stored for more than two years under normal storage conditions, it is recommended that you check the leads for ease of soldering prior to use.

Insulation Related Specifications

		 7.62 mm pitch TLPxxx type	 10.16 mm pitch TLPxxxF type
Minimum creepage distance	Cr	7.0 mm	8.0 mm
Minimum clearance	Cl	7.0 mm	8.0 mm
Minimum insulation thickness	ti	0.4 mm	
Comparative tracking index	CTI	175	

- (1) If a printed circuit is incorporated, the creepage distance and clearance may be reduced below this value. (e.g. at a standard distance between soldering eye centres of 7.5mm). If this is not permissible, the user shall take suitable measures.
- (2) This photocoupler is suitable for 'safe electrical isolation' only within the safety limit data. Maintenance of the safety data shall be ensured by means of protective circuits.

VDE test sign: Marking on product
for EN 60747

4

Marking on packing
for EN 60747



Marking Example: TLP785, TLP785F

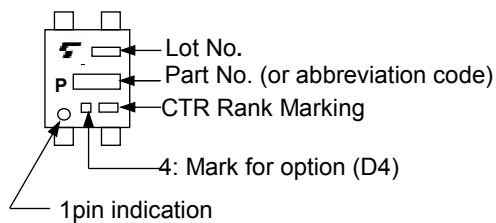

Figure 1 Partial discharge measurement procedure according to EN 60747
Destructive test for qualification and sampling tests.

Method A

(for type and sampling tests,
destructive tests)

- t_1, t_2 = 1 to 10 s
- t_3, t_4 = 1 s
- t_p (Measuring time for partial discharge) = 10 s
- t_b = 12 s
- t_{ini} = 60 s

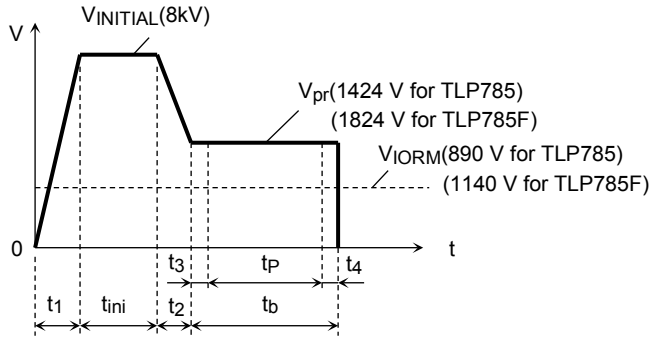

Figure 2 Partial discharge measurement procedure according to EN 60747
Non-destructive test for 100% inspection.

Method B

(for sample test, non-destructive test)

- t_3, t_4 = 0.1 s
- t_p (Measuring time for partial discharge) = 1 s
- t_b = 1.2 s

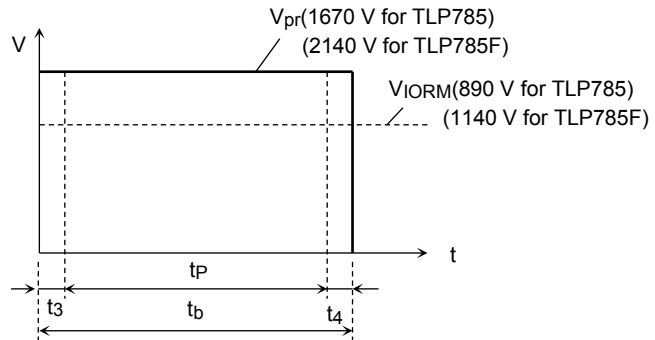
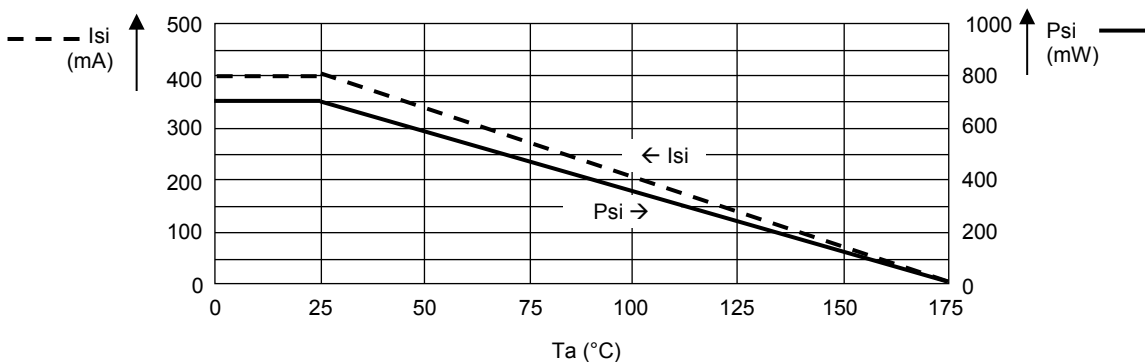
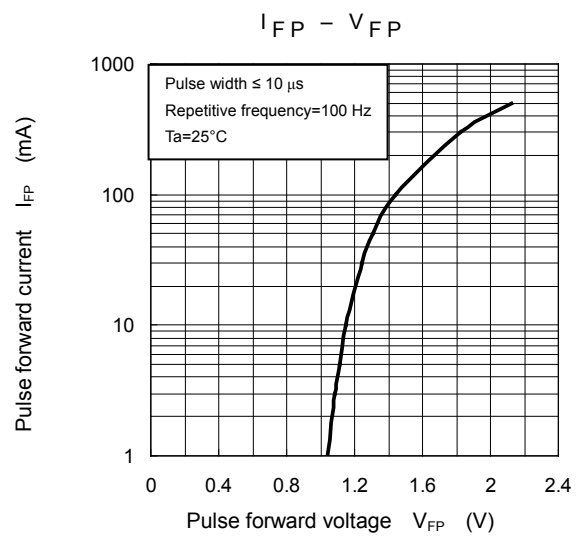
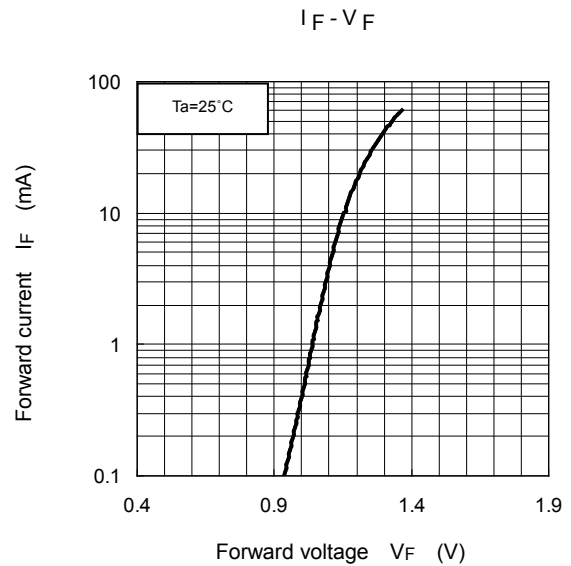
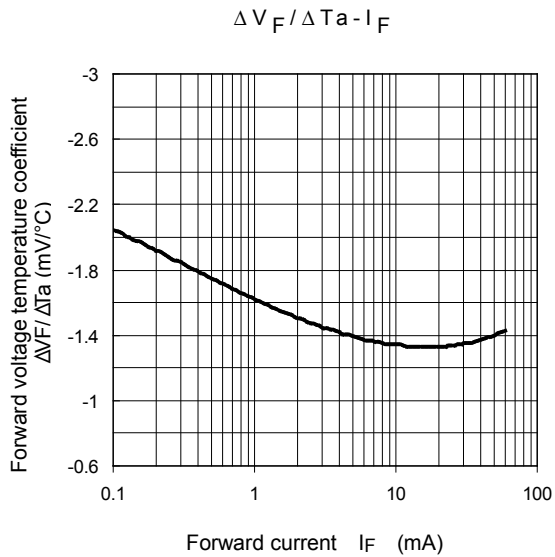
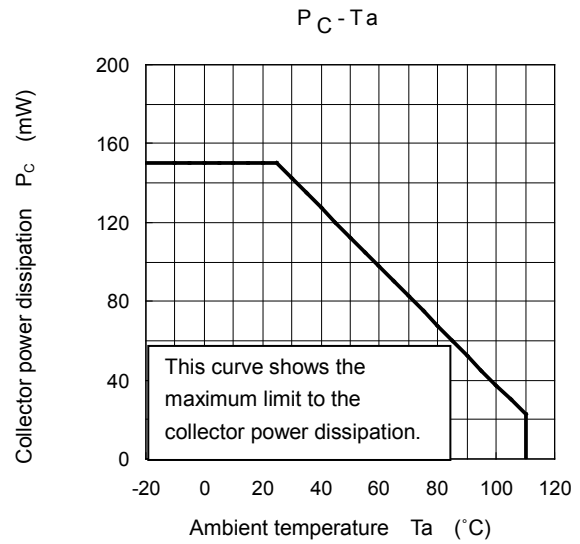
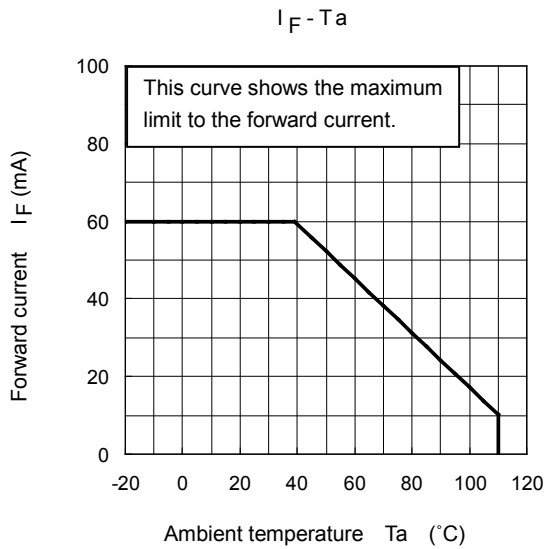
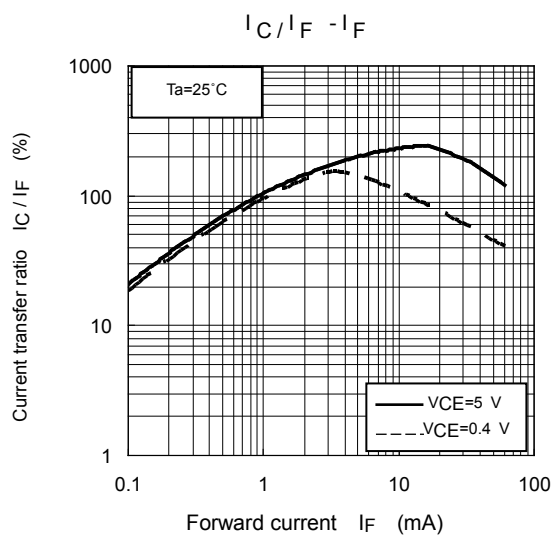
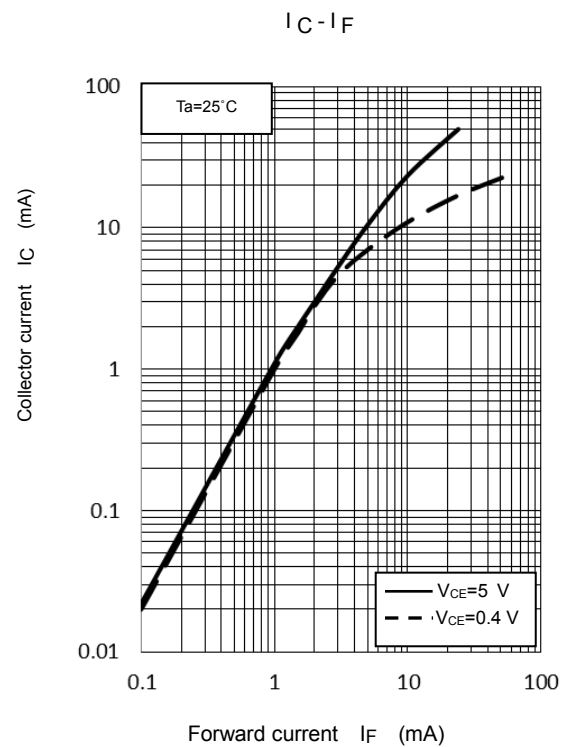
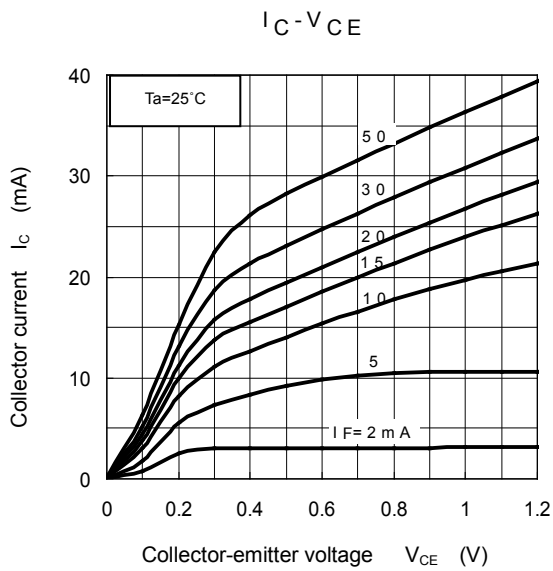
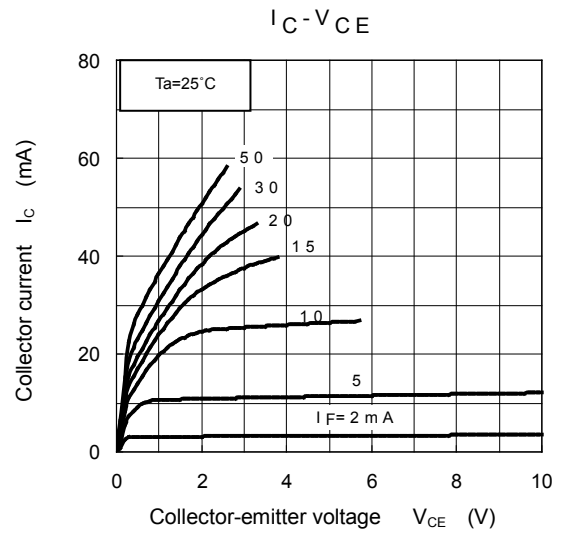
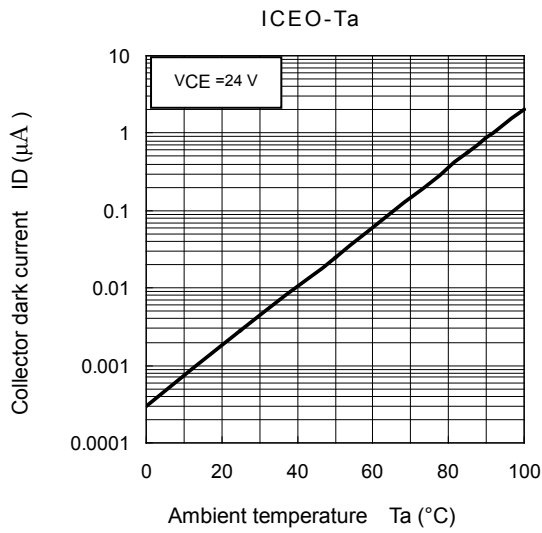

Figure 3 Dependency of maximum safety ratings on ambient temperature





NOTE: The above characteristics curves are presented for reference only and not guaranteed by production test, unless otherwise noted.



NOTE: The above characteristics curves are presented for reference only and not guaranteed by production test, unless otherwise noted.

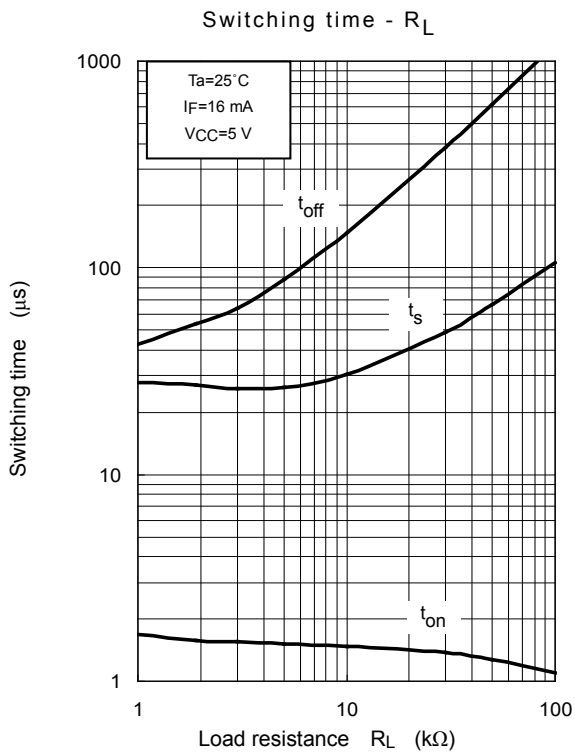
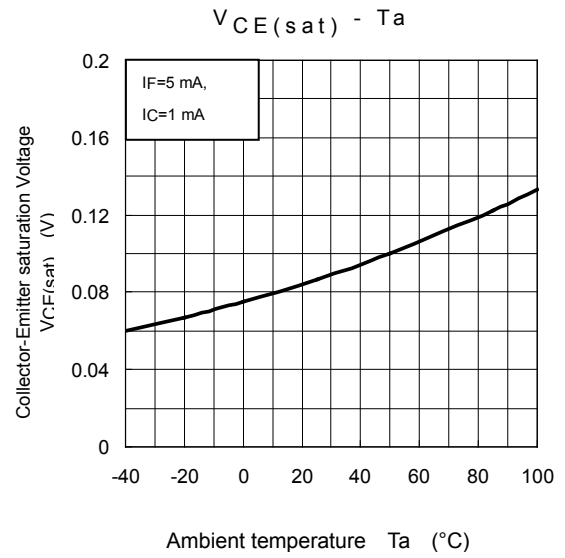
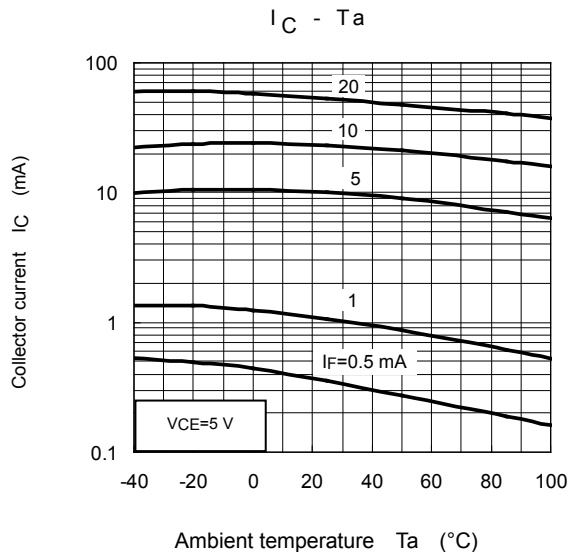

NOTE: The above characteristics curves are presented for reference only and not guaranteed by production test, unless otherwise noted.

RESTRICTIONS ON PRODUCT USE

Toshiba Corporation and its subsidiaries and affiliates are collectively referred to as "TOSHIBA". Hardware, software and systems described in this document are collectively referred to as "Product".

- TOSHIBA reserves the right to make changes to the information in this document and related Product without notice.
- This document and any information herein may not be reproduced without prior written permission from TOSHIBA. Even with TOSHIBA's written permission, reproduction is permissible only if reproduction is without alteration/omission.
- Though TOSHIBA works continually to improve Product's quality and reliability, Product can malfunction or fail. Customers are responsible for complying with safety standards and for providing adequate designs and safeguards for their hardware, software and systems which minimize risk and avoid situations in which a malfunction or failure of Product could cause loss of human life, bodily injury or damage to property, including data loss or corruption. Before customers use the Product, create designs including the Product, or incorporate the Product into their own applications, customers must also refer to and comply with (a) the latest versions of all relevant TOSHIBA information, including without limitation, this document, the specifications, the data sheets and application notes for Product and the precautions and conditions set forth in the "TOSHIBA Semiconductor Reliability Handbook" and (b) the instructions for the application with which the Product will be used with or for. Customers are solely responsible for all aspects of their own product design or applications, including but not limited to (a) determining the appropriateness of the use of this Product in such design or applications; (b) evaluating and determining the applicability of any information contained in this document, or in charts, diagrams, programs, algorithms, sample application circuits, or any other referenced documents; and (c) validating all operating parameters for such designs and applications. **TOSHIBA ASSUMES NO LIABILITY FOR CUSTOMERS' PRODUCT DESIGN OR APPLICATIONS.**
- **PRODUCT IS NEITHER INTENDED NOR WARRANTED FOR USE IN EQUIPMENTS OR SYSTEMS THAT REQUIRE EXTRAORDINARILY HIGH LEVELS OF QUALITY AND/OR RELIABILITY, AND/OR A MALFUNCTION OR FAILURE OF WHICH MAY CAUSE LOSS OF HUMAN LIFE, BODILY INJURY, SERIOUS PROPERTY DAMAGE AND/OR SERIOUS PUBLIC IMPACT ("UNINTENDED USE").** Except for specific applications as expressly stated in this document, Unintended Use includes, without limitation, equipment used in nuclear facilities, equipment used in the aerospace industry, lifesaving and/or life supporting medical equipment, equipment used for automobiles, trains, ships and other transportation, traffic signaling equipment, equipment used to control combustions or explosions, safety devices, elevators and escalators, and devices related to power plant. **IF YOU USE PRODUCT FOR UNINTENDED USE, TOSHIBA ASSUMES NO LIABILITY FOR PRODUCT.** For details, please contact your TOSHIBA sales representative or contact us via our website.
- Do not disassemble, analyze, reverse-engineer, alter, modify, translate or copy Product, whether in whole or in part.
- Product shall not be used for or incorporated into any products or systems whose manufacture, use, or sale is prohibited under any applicable laws or regulations.
- The information contained herein is presented only as guidance for Product use. No responsibility is assumed by TOSHIBA for any infringement of patents or any other intellectual property rights of third parties that may result from the use of Product. No license to any intellectual property right is granted by this document, whether express or implied, by estoppel or otherwise.
- **ABSENT A WRITTEN SIGNED AGREEMENT, EXCEPT AS PROVIDED IN THE RELEVANT TERMS AND CONDITIONS OF SALE FOR PRODUCT, AND TO THE MAXIMUM EXTENT ALLOWABLE BY LAW, TOSHIBA (1) ASSUMES NO LIABILITY WHATSOEVER, INCLUDING WITHOUT LIMITATION, INDIRECT, CONSEQUENTIAL, SPECIAL, OR INCIDENTAL DAMAGES OR LOSS, INCLUDING WITHOUT LIMITATION, LOSS OF PROFITS, LOSS OF OPPORTUNITIES, BUSINESS INTERRUPTION AND LOSS OF DATA, AND (2) DISCLAIMS ANY AND ALL EXPRESS OR IMPLIED WARRANTIES AND CONDITIONS RELATED TO SALE, USE OF PRODUCT, OR INFORMATION, INCLUDING WARRANTIES OR CONDITIONS OF MERCHANTABILITY, FITNESS FOR A PARTICULAR PURPOSE, ACCURACY OF INFORMATION, OR NONINFRINGEMENT.**
- GaAs (Gallium Arsenide) is used in Product. GaAs is harmful to humans if consumed or absorbed, whether in the form of dust or vapor. Handle with care and do not break, cut, crush, grind, dissolve chemically or otherwise expose GaAs in Product.
- Do not use or otherwise make available Product or related software or technology for any military purposes, including without limitation, for the design, development, use, stockpiling or manufacturing of nuclear, chemical, or biological weapons or missile technology products (mass destruction weapons). Product and related software and technology may be controlled under the applicable export laws and regulations including, without limitation, the Japanese Foreign Exchange and Foreign Trade Law and the U.S. Export Administration Regulations. Export and re-export of Product or related software or technology are strictly prohibited except in compliance with all applicable export laws and regulations.
- Please contact your TOSHIBA sales representative for details as to environmental matters such as the RoHS compatibility of Product. Please use Product in compliance with all applicable laws and regulations that regulate the inclusion or use of controlled substances, including without limitation, the EU RoHS Directive. **TOSHIBA ASSUMES NO LIABILITY FOR DAMAGES OR LOSSES OCCURRING AS A RESULT OF NONCOMPLIANCE WITH APPLICABLE LAWS AND REGULATIONS.**

Looking for pricing, stock, or lifecycle information?

Click below to explore more details on WIN SOURCE:

- [View TLP785\(D4-GB,F\) on WIN SOURCE](#)
- [Toshiba Semiconductor and Storage Information](#)

Optimize Your Supply Chain with WIN SOURCE Solutions

- ✓ Global Sourcing Solution
- ✓ Obsolete Management
- ✓ Cost Control Management
- ✓ Shortage Management
- ✓ Alternative Solution
- ✓ Excess Inventory Management