

# TLP285

**Power Supplies**  
**Programmable Controllers**  
**Hybrid ICs**

The Toshiba TLP285 consists of photo transistor, optically coupled to a gallium arsenide infrared emitting diode. TLP285 is housed in the SOP4 package, very small and thin coupler.

Since TLP285 is guaranteed wide operating temperature ( $T_a = -55$  to  $110\text{ }^\circ\text{C}$ ) and high isolation voltage (3750 Vrms), it's suitable for high-density surface mounting applications such as small switching power supplies and programmable controllers.

- Collector-Emitter Voltage : 80 V (min)
- Current Transfer Ratio : 50% (min)  
 Rank GB : 100% (min)
- Isolation Voltage : 3750 Vrms (min)
- Guaranteed performance over  $-55$  to  $110\text{ }^\circ\text{C}$
- UL Recognized : UL1577, File No. E67349
- cUL Recognized : CSA Component Acceptance Service  
 No.5A, File No. E67349

- Option (V4)  
 VDE approved : EN60747-5-5  
 Maximum operating insulation voltage : 707 Vpk  
 Highest permissible over-voltage : 6000 Vpk

**Note: When a EN60747-5-5 approved type is needed, please designate the "Option(V4)"**

**Construction Mechanical Rating**

Creepage Distance	5.0 mm (min)
Clearance	5.0 mm (min)
Insulation Thickness	0.4 mm (min)

Unit: mm

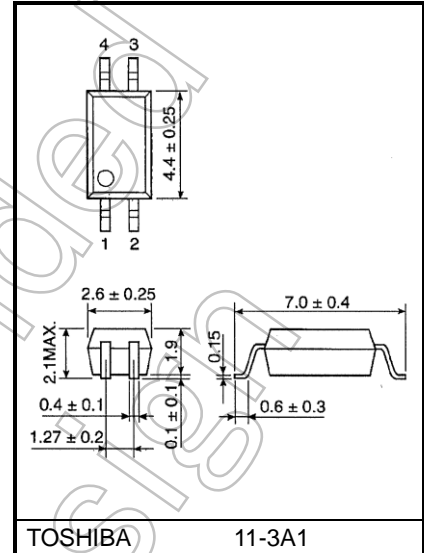

Weight: 0.05 g (typ.)

**Pin Configuration (top view)**

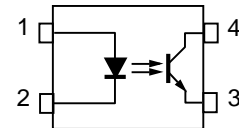

- 1: ANODE
- 2: CATHODE
- 3: EMITTER
- 4: COLLECTOR

Start of commercial production  
 2008-01

## Current Transfer Ratio

TYPE	Classification (Note1)	Current Transfer Ratio (%) (I <sub>C</sub> /I <sub>F</sub> )		Marking of Classification
		I <sub>F</sub> = 5 mA, V <sub>CE</sub> = 5 V, T <sub>a</sub> = 25°C		
		Min	Max	
TLP285	Blank	50	600	Blank, Y <sup>■</sup> , YE, G, G <sup>■</sup> , GR, B, BL, GB
	Rank Y	50	150	YE, Y <sup>■</sup>
	Rank GR	100	300	GR, G, G <sup>■</sup>
	Rank BL	200	600	BL, B
	Rank GB	100	600	GB, GR, G, G <sup>■</sup> , BL, B
	Rank YH	75	150	Y <sup>■</sup>
	Rank GRL	100	200	G
	Rank GRH	150	300	G <sup>■</sup>
	Rank BLL	200	400	B

Note1: Ex. rank GB: TLP285 (GB)

Note: Application type name for certification test, please use standard product type name, i.e.  
TLP285 (GB): TLP285

Not Recommended for New Design

**Absolute Maximum Ratings (Ta = 25°C)**

CHARACTERISTIC		SYMBOL	RATING	UNIT
LED	Forward Current	IF(RMS)	50	mA
	Forward Current Derating (Ta ≥ 75°C)	ΔIF/°C	-1.0	mA/°C
	Pulse Forward Current (Note 1)	IFP	1	A
	Reverse Voltage	VR	5	V
	Diode power dissipation	PD	100	mW
	Diode power dissipation derating (Ta ≥ 75°C)	ΔPD/°C	-2.0	mW/°C
	Junction Temperature	Tj	125	°C
DETECTOR	Collector-Emitter Voltage	VCEO	80	V
	Emitter-Collector Voltage	VECO	7	V
	Collector Current	IC	50	mA
	Collector Power Dissipation	PC	150	mW
	Collector Power Dissipation Derating (Ta ≥ 25°C)	ΔPC/°C	-1.5	mW/°C
	Junction Temperature	Tj	125	°C
Operating Temperature Range		Topr	-55 to 110	°C
Storage Temperature Range		Tstg	-55 to 125	°C
Lead Soldering Temperature (10 s)		Tsol	260	°C
Total Package Power Dissipation		PT	200	mW
Total Package Power Dissipation Derating (Ta ≥ 25°C)		ΔPT/°C	-2.0	mW/°C
Isolation Voltage (Note 2)		BVS	3750	Vrms

Note: Using continuously under heavy loads (e.g. the application of high temperature/current/voltage and the significant change in temperature, etc.) may cause this product to decrease in the reliability significantly even if the operating conditions (i.e. operating temperature/current/voltage, etc.) are within the absolute maximum ratings.

Please design the appropriate reliability upon reviewing the Toshiba Semiconductor Reliability Handbook ("Handling Precautions"/"Derating Concept and Methods") and individual reliability data (i.e. reliability test report and estimated failure rate, etc).

Note 1: Pulse width ≤ 100 μs, frequency 100 Hz

Note 2: AC, 60 s, R.H.≤60%

Device considered a two terminal device : LED side pins shorted together and DETECTOR side pins shorted together.

**Electrical Characteristics (Ta = 25°C)**

CHARACTERISTIC		SYMBOL	TEST CONDITION	MIN	TYP.	MAX	UNIT
LED	Forward Voltage	VF	IF = 10 mA	1.0	1.15	1.3	V
	Reverse Current	IR	VR = 5 V	—	—	10	μA
	Capacitance	CT	V = 0 V, f = 1 MHz	—	30	—	pF
DETECTOR	Collector-Emitter Breakdown Voltage	V(BR)CEO	IC = 0.5 mA	80	—	—	V
	Emitter-Collector Breakdown Voltage	V(BR)ECO	IE = 0.1 mA	7	—	—	V
	Collector Dark Current (Note 2)	ICEO	VCE = 48 V, Ambient Light Below (100 lx) (Note 1)	—	0.01 (2)	0.1 (10)	μA
			VCE = 48 V, Ta = 85°C Ambient Light Below (100 lx) (Note 1)	—	2 (4)	50 (50)	μA
Capacitance (Collector to Emitter)		CCE	V = 0 V, f = 1 MHz	—	10	—	pF

Note 1: Irradiation to marking side using standard light bulb.

Note 2: Because of the construction, leak current might be increased by ambient light.

Please use photocoupler with less ambient light.

**Coupled Electrical Characteristics (Ta = 25°C)**

CHARACTERISTIC	SYMBOL	TEST CONDITION	MIN	TYP.	MAX	UNIT
Current Transfer Ratio	I <sub>C</sub> /I <sub>F</sub>	I <sub>F</sub> = 5 mA, V <sub>CE</sub> = 5 V Rank GB	50	—	600	%
			100	—	600	
Saturated CTR	I <sub>C</sub> /I <sub>F(sat)</sub>	I <sub>F</sub> = 1 mA, V <sub>CE</sub> = 0.4 V Rank GB	—	60	—	%
			30	—	—	
Collector-Emitter Saturation Voltage	V <sub>CE(sat)</sub>	I <sub>C</sub> = 2.4 mA, I <sub>F</sub> = 8 mA I <sub>C</sub> = 0.2 mA, I <sub>F</sub> = 1 mA Rank GB	—	—	0.4	V
			—	0.2	—	
OFF-State Collector Current	I <sub>C(off)</sub>	V <sub>F</sub> = 0.7 V, V <sub>CE</sub> = 48 V	—	—	10	μA

**Isolation Characteristics (Ta = 25°C)**

CHARACTERISTIC	SYMBOL	TEST CONDITION	MIN	TYP.	MAX	UNIT
Capacitance (Input to Output)	C <sub>S</sub>	V <sub>S</sub> = 0 V, f = 1 MHz	—	0.8	—	pF
Isolation Resistance	R <sub>S</sub>	V <sub>S</sub> = 500 V, R.H. ≤ 60%	1 × 10 <sup>12</sup>	10 <sup>14</sup>	—	Ω
Isolation Voltage	BV <sub>S</sub>	AC, 60 s	3750	—	—	V <sub>rms</sub>
		AC, 1 s, in OIL	—	10000	—	V <sub>dc</sub>
		DC, 60 s, in OIL	—	10000	—	

**Switching Characteristics (Ta = 25°C)**

CHARACTERISTIC	SYMBOL	TEST CONDITION	MIN	TYP.	MAX	UNIT
Rise Time	t <sub>r</sub>	V <sub>CC</sub> = 10 V, I <sub>C</sub> = 2 mA R <sub>L</sub> = 100 Ω	—	2	—	μs
Fall Time	t <sub>f</sub>		—	3	—	
Turn-On Time	t <sub>on</sub>		—	3	—	
Turn-Off Time	t <sub>off</sub>		—	3	—	
Turn-On Time	t <sub>ON</sub>	R <sub>L</sub> = 1.9 kΩ V <sub>CC</sub> = 5 V, I <sub>F</sub> = 16 mA (Fig.1)	—	2	—	μs
Storage Time	t <sub>s</sub>		—	25	—	
Turn-Off Time	t <sub>OFF</sub>		—	40	—	

Fig.1: Switching Time Test Circuit

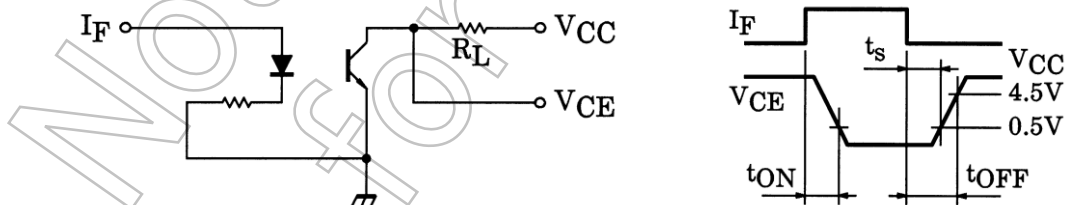

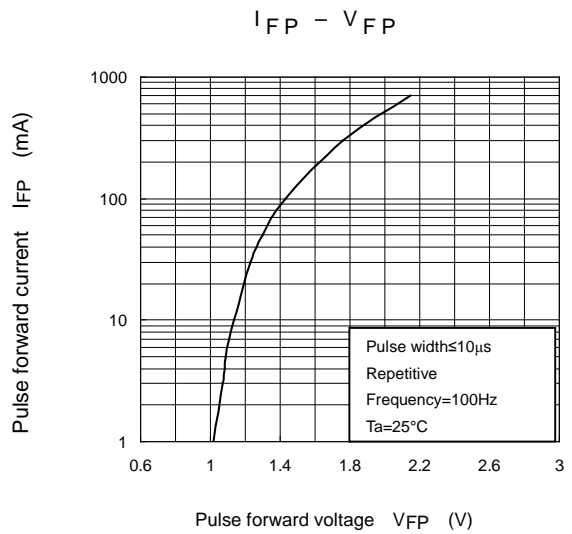
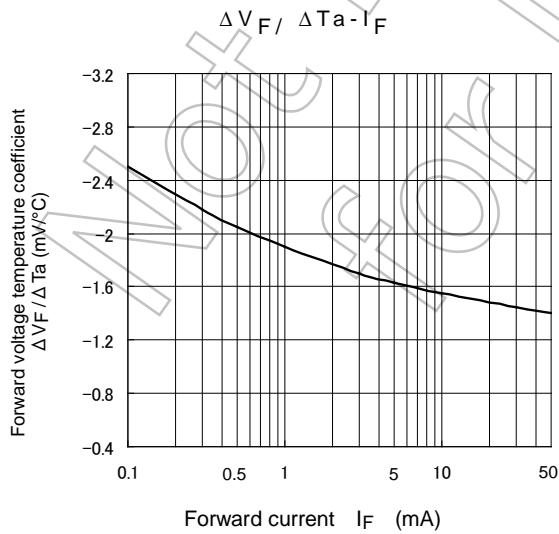
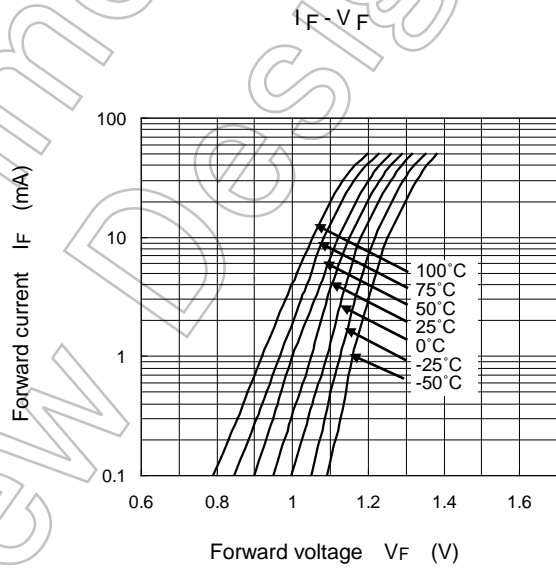
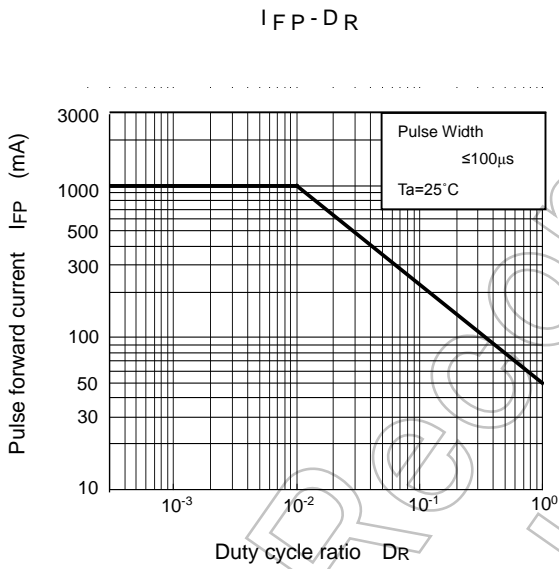
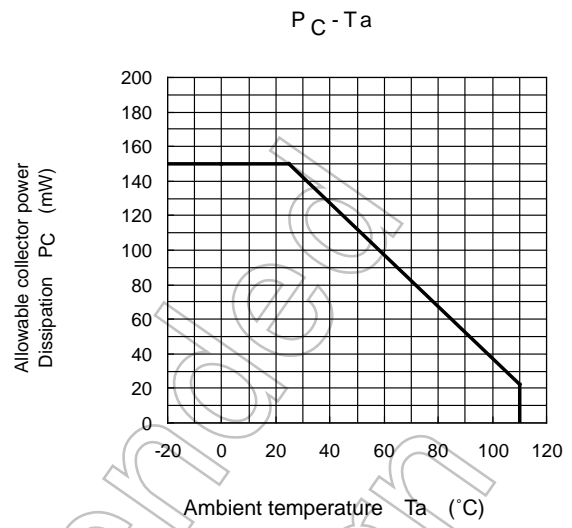
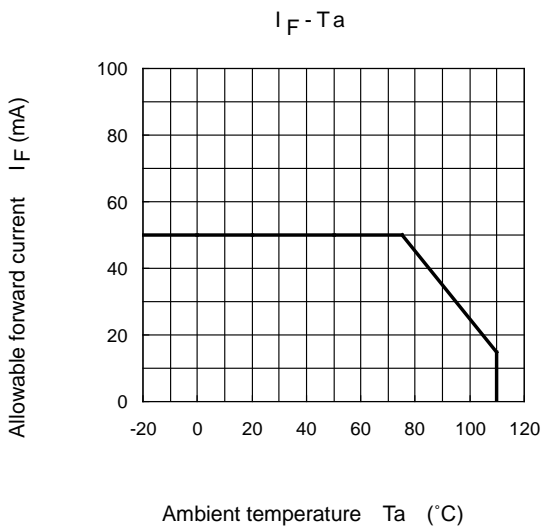

\*The above graphs show typical characteristic.

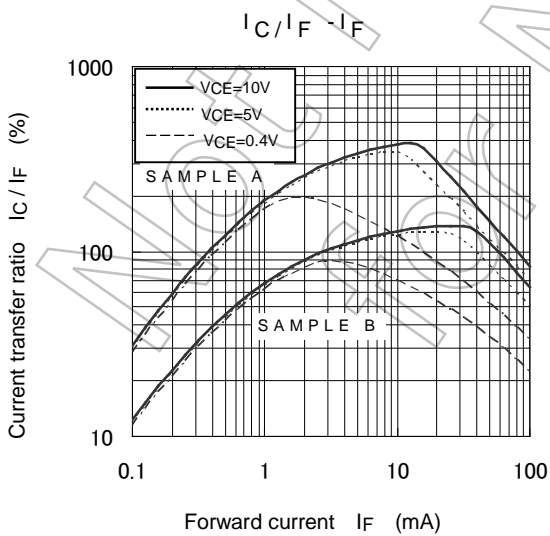
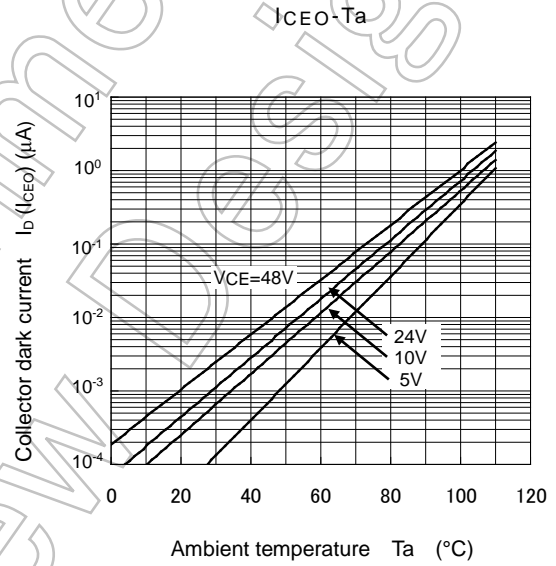
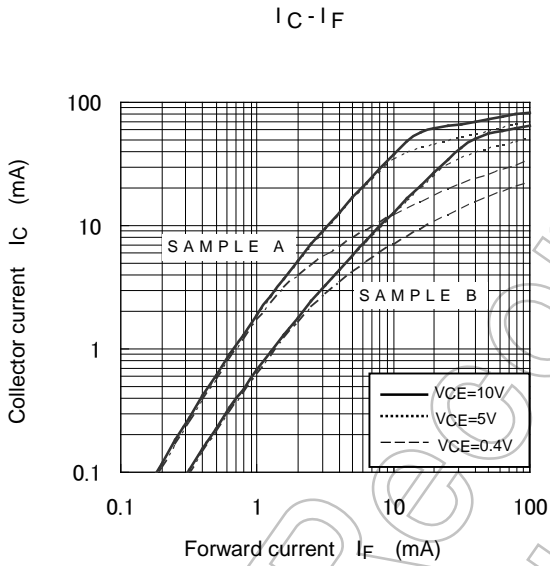
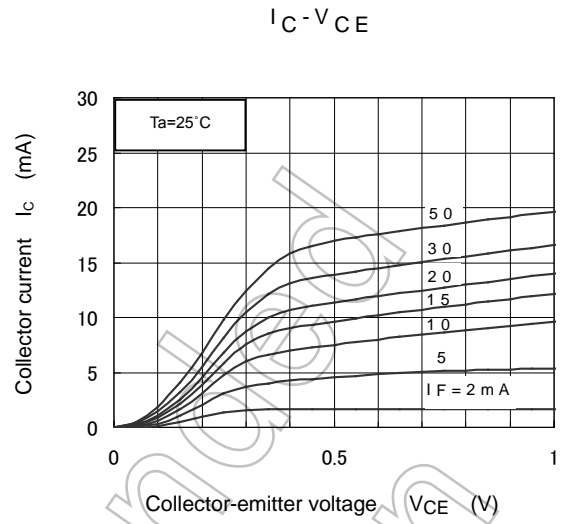
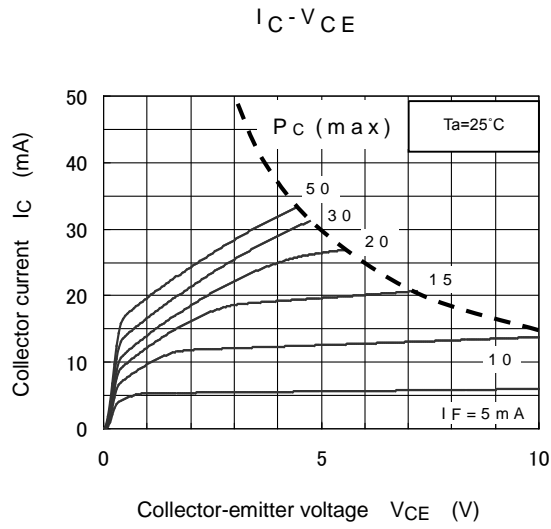

\*The above graphs show typical characteristic.

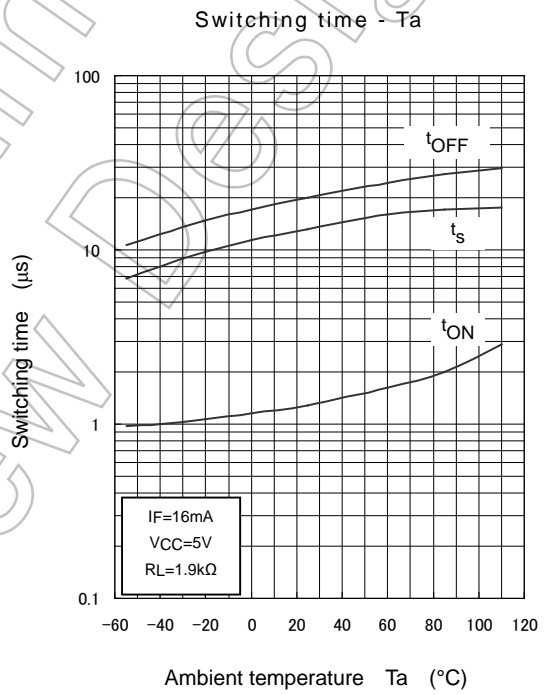
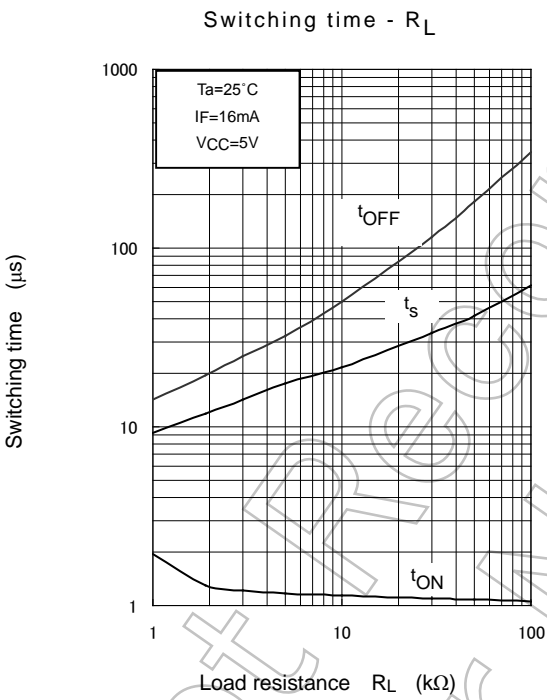
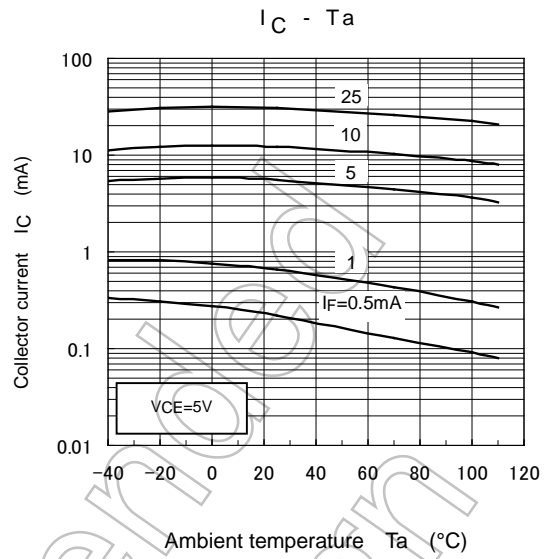
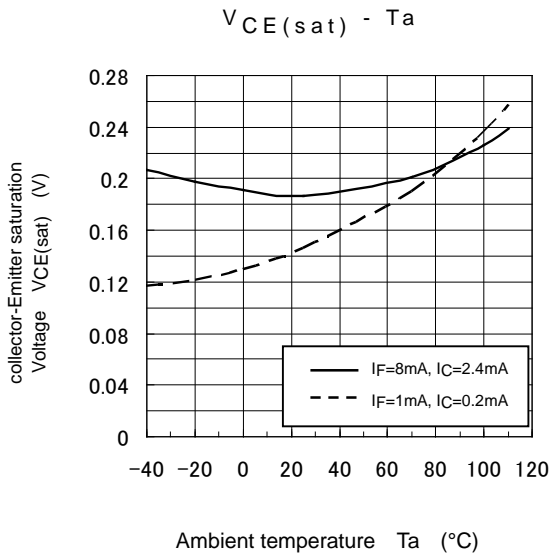

\*The above graphs show typical characteristic.

## Soldering and Storage

### 1. Soldering

#### Soldering

When using a soldering iron or medium infrared ray/hot air reflow, avoid a rise in device temperature as much as possible by observing the following conditions.

#### 1) Using solder reflow

· Temperature profile example of lead (Pb) solder

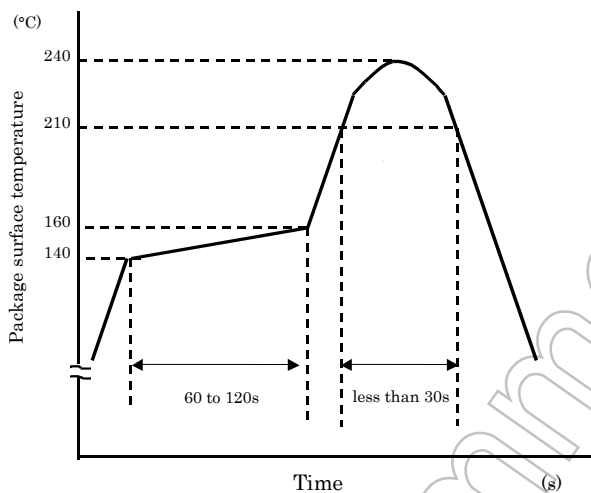

This profile is based on the device's maximum heat resistance guaranteed value. Set the preheat temperature/heating temperature to the optimum temperature corresponding to the solder paste type used by the customer within the described profile.

· Temperature profile example of using lead (Pb)-free solder

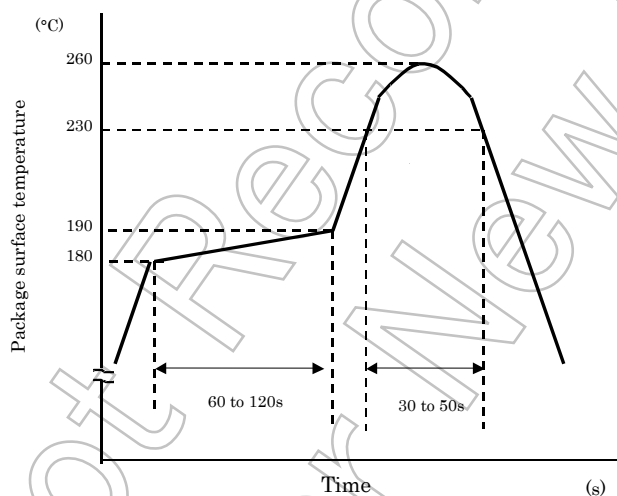

This profile is based on the device's maximum heat resistance guaranteed value. Set the preheat temperature/heating temperature to the optimum temperature corresponding to the solder paste type used by the customer within the described profile.

Reflow soldering must be performed once or twice.

The mounting should be completed with the interval from the first to the last mountings being 2 weeks.

#### 2) Using solder flow (for lead (Pb) solder, or lead (Pb)-free solder)

- Please preheat it at 150°C between 60 and 120 seconds.
- Complete soldering within 10 seconds below 260°C. Each pin may be heated at most once.

#### 3) Using a soldering iron

Complete soldering within 10 seconds below 260°C, or within 3 seconds at 350°C. Each pin may be heated at most once.

## 2. Storage

- 1) Avoid storage locations where devices may be exposed to moisture or direct sunlight.
- 2) Follow the precautions printed on the packing label of the device for transportation and storage.
- 3) Keep the storage location temperature and humidity within a range of 5°C to 35°C and 45% to 75%, respectively.
- 4) Do not store the products in locations with poisonous gases (especially corrosive gases) or in dusty conditions.
- 5) Store the products in locations with minimal temperature fluctuations. Rapid temperature changes during storage can cause condensation, resulting in lead oxidation or corrosion, which will deteriorate the solderability of the leads.
- 6) When restoring devices after removal from their packing, use anti-static containers.
- 7) Do not allow loads to be applied directly to devices while they are in storage.
- 8) If devices have been stored for more than two years under normal storage conditions, it is recommended that you check the leads for ease of soldering prior to use.

Not Recommended  
for New Design

# Embossed-Tape Packing (TP) Specification for Mini-Flat Couplers

## 1. Applicable Package

Package	Product Type
SOP4	Mini-Flat Coupler

## 2. Product Naming System

Type of package used for shipment is denoted by a symbol suffix after a product number. The method of classification is as below.

(Example)

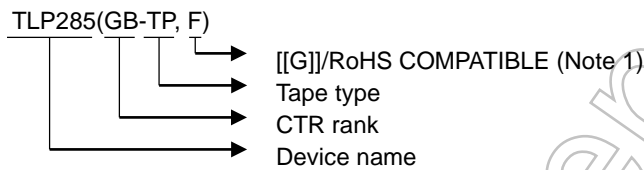

Note 1: Please contact your TOSHIBA sales representative for details as to environmental matters such as the RoHS compatibility of Product.

The RoHS is the Directive 2011/65/EU of the European Parliament and of the Council of 8 June 2011 on the restriction of the use of certain hazardous substances in electrical and electronic equipment.

## 3. Tape Dimensions

### 3.1 Orientation of Device in Relation to Direction of Tape Movement

Device orientation in the recesses is as shown in Figure 2.

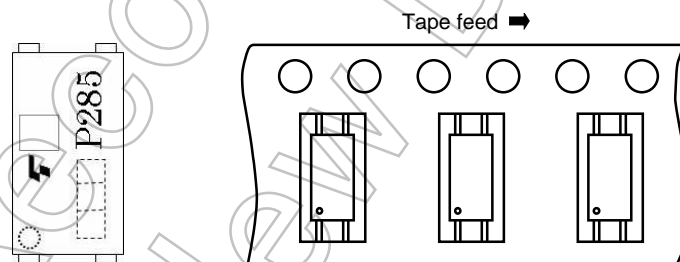

Figure 2 Device Orientation

### 3.2 Tape Packing Quantity: 2500 devices per reel

### 3.3 Empty Device Recesses Are as Shown in Table 1.

Table 1 Empty Device Recesses

	Standard	Remarks
Occurrences of 2 or more successive empty device recesses	0 device	Within any given 40-mm section of tape, not including leader and trailer
Single empty device recesses	6 device (max.) per reel	Not including leader and trailer

### 3.4 Start and End of Tape

The start of the tape has 50 or more empty holes. The end of tape has 50 or more empty holes and two empty turns only for a cover tape.

**3.5 Tape Specification**

- (1) Tape material: Plastic (protection against electrostatics)
- (2) Dimensions: The tape dimensions are as shown in Figure 3 and table 2.

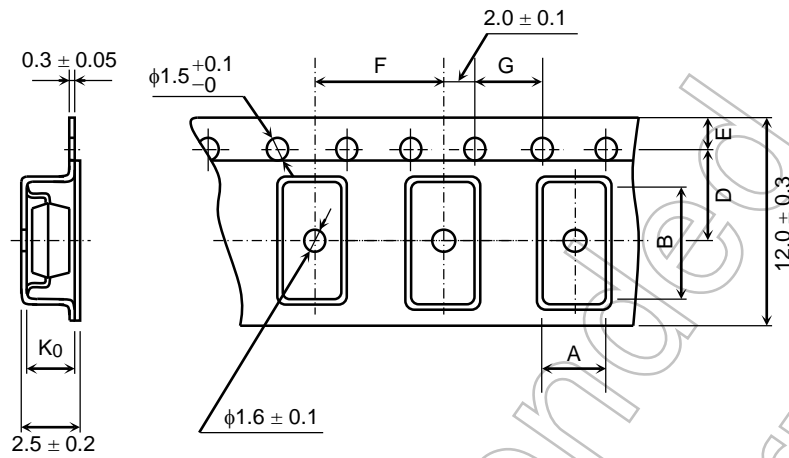

**Figure 3 Tape Forms**

**Table 2 Tape Dimensions**

Unit: mm  
Unless otherwise specified: ±0.1

Symbol	Dimension	Remark
A	3.1	—
B	7.5	—
D	5.5	Center line of indented square hole and sprocket hole
E	1.75	Distance between tape edge and hole center
F	8.0	Cumulative error $\begin{matrix} +0.1 \\ -0.3 \end{matrix}$ (max) per 10 feed holes
G	4.0	Cumulative error $\begin{matrix} +0.1 \\ -0.3 \end{matrix}$ (max) per 10 feed holes
K <sub>0</sub>	2.3	Internal space

**3.6 Reel**

- (1) Material: Plastic
- (2) Dimensions: The reel dimensions are as shown in Figure 4 and Table 3.

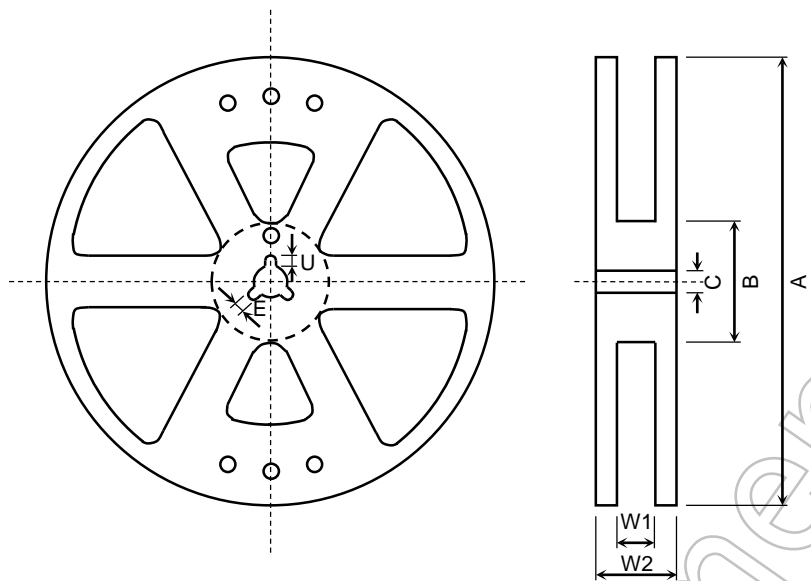

**Figure 4 Reel Form**

**Table 3 Reel Dimensions**

Unit: mm

Symbol	Dimension
A	$\Phi 330 \pm 2$
B	$\Phi 80 \pm 1$
C	$\Phi 13 \pm 0.5$
E	$2.0 \pm 0.5$
U	$4.0 \pm 0.5$
W1	$13.5 \pm 0.5$
W2	$17.5 \pm 1.0$

**4. Packing**

Either one reel or ten reels of photocoupler are packed in a shipping carton.

**5. Label Indication**

The carton bears a label indicating the product number, the symbol representing classification of standard, the quantity, the lot number and the Toshiba company name.

**6. Ordering Method**

When placing an order, please specify the product number, the CTR rank, the tape type and the quantity as shown in the following example.

(Example)

TLP285(GB-TP,F) 2500 pcs

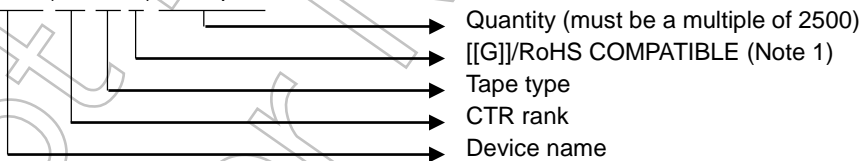

Note 1 : Please contact your TOSHIBA sales representative for details as to environmental matters such as the RoHS compatibility of Product.

The RoHS is the Directive 2011/65/EU of the European Parliament and of the Council of 8 June 2011 on the restriction of the use of certain hazardous substances in electrical and electronic equipment.



**Insulation Related Specifications**

Minimum creepage distance	Cr	5.0 mm
Minimum clearance	Cl	5.0 mm
Minimum insulation thickness	ti	0.4 mm
Comparative tracking index	CTI	175

Note: If a printed circuit is incorporated, the creepage distance and clearance may be reduced below this value. If this is not permissible, the user shall take suitable measures.

Note: This photocoupler is suitable for 'safe electrical isolation' only within the safety limit data. Maintenance of the safety data shall be ensured by means of protective circuit.

VDE test sign:



Marking on packing



Marking Example

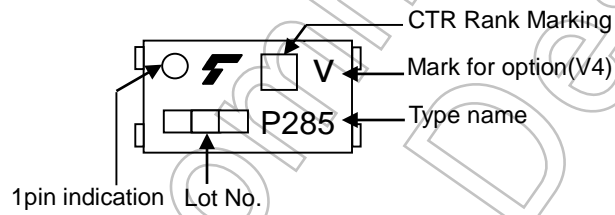

Not Recommended for New Design

Figure 1 Partial discharge measurement procedure according to EN60747  
Destructive test for qualification and sampling tests.

Method A

(for type and sampling tests,  
destructive tests)

- $t_1, t_2$  = 1 to 10 s
- $t_3, t_4$  = 1 s
- $t_p$ (Measuring time for partial discharge) = 10 s
- $t_b$  = 12 s
- $t_{inj}$  = 60 s

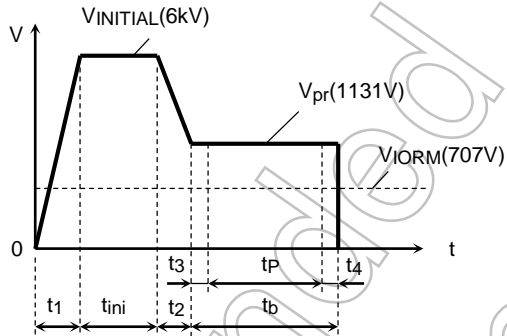

Figure 2 Partial discharge measurement procedure according to EN60747  
Non-destructive test for 100% inspection.

Method B

(for sample test, non-destructive test)

- $t_3, t_4$  = 0.1 s
- $t_p$ (Measuring time for partial discharge) = 1 s
- $t_b$  = 1.2 s

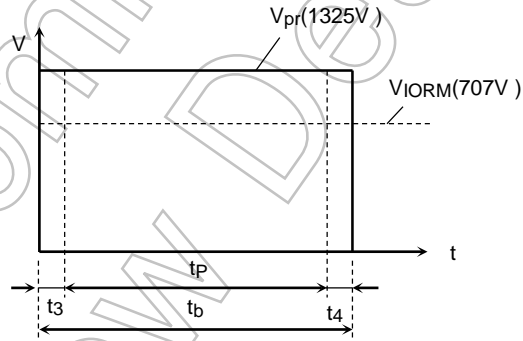
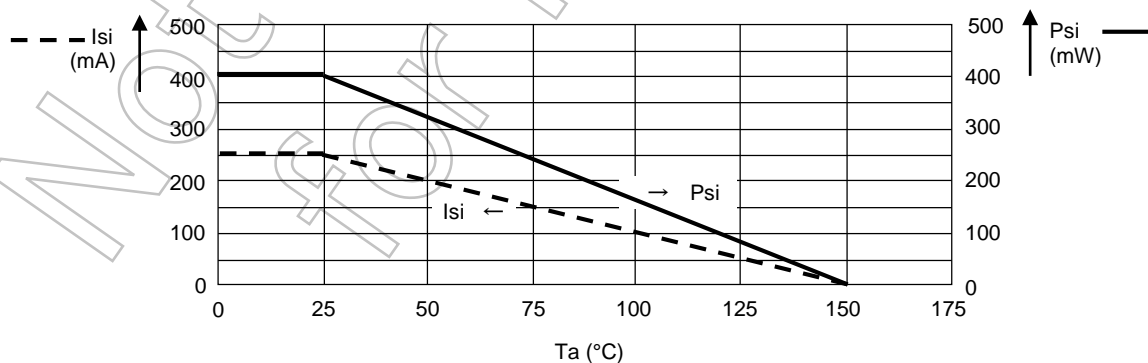

Figure 3 Dependency of maximum safety ratings on ambient temperature



## RESTRICTIONS ON PRODUCT USE

- Toshiba Corporation, and its subsidiaries and affiliates (collectively "TOSHIBA"), reserve the right to make changes to the information in this document, and related hardware, software and systems (collectively "Product") without notice.
- This document and any information herein may not be reproduced without prior written permission from TOSHIBA. Even with TOSHIBA's written permission, reproduction is permissible only if reproduction is without alteration/omission.
- Though TOSHIBA works continually to improve Product's quality and reliability, Product can malfunction or fail. Customers are responsible for complying with safety standards and for providing adequate designs and safeguards for their hardware, software and systems which minimize risk and avoid situations in which a malfunction or failure of Product could cause loss of human life, bodily injury or damage to property, including data loss or corruption. Before customers use the Product, create designs including the Product, or incorporate the Product into their own applications, customers must also refer to and comply with (a) the latest versions of all relevant TOSHIBA information, including without limitation, this document, the specifications, the data sheets and application notes for Product and the precautions and conditions set forth in the "TOSHIBA Semiconductor Reliability Handbook" and (b) the instructions for the application with which the Product will be used with or for. Customers are solely responsible for all aspects of their own product design or applications, including but not limited to (a) determining the appropriateness of the use of this Product in such design or applications; (b) evaluating and determining the applicability of any information contained in this document, or in charts, diagrams, programs, algorithms, sample application circuits, or any other referenced documents; and (c) validating all operating parameters for such designs and applications. **TOSHIBA ASSUMES NO LIABILITY FOR CUSTOMERS' PRODUCT DESIGN OR APPLICATIONS.**
- **PRODUCT IS NEITHER INTENDED NOR WARRANTED FOR USE IN EQUIPMENTS OR SYSTEMS THAT REQUIRE EXTRAORDINARILY HIGH LEVELS OF QUALITY AND/OR RELIABILITY, AND/OR A MALFUNCTION OR FAILURE OF WHICH MAY CAUSE LOSS OF HUMAN LIFE, BODILY INJURY, SERIOUS PROPERTY DAMAGE AND/OR SERIOUS PUBLIC IMPACT ("UNINTENDED USE").** Except for specific applications as expressly stated in this document, Unintended Use includes, without limitation, equipment used in nuclear facilities, equipment used in the aerospace industry, medical equipment, equipment used for automobiles, trains, ships and other transportation, traffic signaling equipment, equipment used to control combustions or explosions, safety devices, elevators and escalators, devices related to electric power, and equipment used in finance-related fields. **IF YOU USE PRODUCT FOR UNINTENDED USE, TOSHIBA ASSUMES NO LIABILITY FOR PRODUCT.** For details, please contact your TOSHIBA sales representative.
- Do not disassemble, analyze, reverse-engineer, alter, modify, translate or copy Product, whether in whole or in part.
- Product shall not be used for or incorporated into any products or systems whose manufacture, use, or sale is prohibited under any applicable laws or regulations.
- The information contained herein is presented only as guidance for Product use. No responsibility is assumed by TOSHIBA for any infringement of patents or any other intellectual property rights of third parties that may result from the use of Product. No license to any intellectual property right is granted by this document, whether express or implied, by estoppel or otherwise.
- **ABSENT A WRITTEN SIGNED AGREEMENT, EXCEPT AS PROVIDED IN THE RELEVANT TERMS AND CONDITIONS OF SALE FOR PRODUCT, AND TO THE MAXIMUM EXTENT ALLOWABLE BY LAW, TOSHIBA (1) ASSUMES NO LIABILITY WHATSOEVER, INCLUDING WITHOUT LIMITATION, INDIRECT, CONSEQUENTIAL, SPECIAL, OR INCIDENTAL DAMAGES OR LOSS, INCLUDING WITHOUT LIMITATION, LOSS OF PROFITS, LOSS OF OPPORTUNITIES, BUSINESS INTERRUPTION AND LOSS OF DATA, AND (2) DISCLAIMS ANY AND ALL EXPRESS OR IMPLIED WARRANTIES AND CONDITIONS RELATED TO SALE, USE OF PRODUCT, OR INFORMATION, INCLUDING WARRANTIES OR CONDITIONS OF MERCHANTABILITY, FITNESS FOR A PARTICULAR PURPOSE, ACCURACY OF INFORMATION, OR NONINFRINGEMENT.**
- GaAs (Gallium Arsenide) is used in Product. GaAs is harmful to humans if consumed or absorbed, whether in the form of dust or vapor. Handle with care and do not break, cut, crush, grind, dissolve chemically or otherwise expose GaAs in Product.
- Do not use or otherwise make available Product or related software or technology for any military purposes, including without limitation, for the design, development, use, stockpiling or manufacturing of nuclear, chemical, or biological weapons or missile technology products (mass destruction weapons). Product and related software and technology may be controlled under the applicable export laws and regulations including, without limitation, the Japanese Foreign Exchange and Foreign Trade Law and the U.S. Export Administration Regulations. Export and re-export of Product or related software or technology are strictly prohibited except in compliance with all applicable export laws and regulations.
- Please contact your TOSHIBA sales representative for details as to environmental matters such as the RoHS compatibility of Product. Please use Product in compliance with all applicable laws and regulations that regulate the inclusion or use of controlled substances, including without limitation, the EU RoHS Directive. **TOSHIBA ASSUMES NO LIABILITY FOR DAMAGES OR LOSSES OCCURRING AS A RESULT OF NONCOMPLIANCE WITH APPLICABLE LAWS AND REGULATIONS.**

## Looking for pricing, stock, or lifecycle information?

Click below to explore more details on WIN SOURCE:

- ⊖ [View TLP285\(V4GHTPR.E.T\) on WIN SOURCE](#)
- ⊖ [Toshiba Semiconductor and Storage Information](#)

## Optimize Your Supply Chain with WIN SOURCE Solutions

- ✓ Global Sourcing Solution
- ✓ Obsolete Management
- ✓ Cost Control Management
- ✓ Shortage Management
- ✓ Alternative Solution
- ✓ Excess Inventory Management