

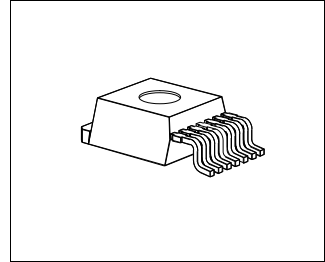

Features

- Adjustable constant current up to 500 mA ($\pm 5\%$)
- Wide input voltage range up to 42 V
- Low drop voltage
- Open load detection
- Overtemperature protection
- Short circuit proof
- Reverse polarity proof
- Wide temperature range: $-40\text{ }^{\circ}\text{C}$ to $150\text{ }^{\circ}\text{C}$
- Green Product (RoHS compliant)
- AEC Qualified

Functional Description

The TLE 4242 G is an integrated adjustable constant current source driving loads up to 500 mA. The output current level can be adjusted via an external resistor. The IC is designed to supply high power LEDs (e.g. Osram Dragon LA W57B) under the severe conditions of automotive applications resulting in constant brightness and extended LED lifetime. It is provided in the surface mounted PG-TO263-7-1 package. Protection circuits prevent damage to the device in case of overload, short circuit, reverse polarity and overheat. The connected LEDs are protected against reverse polarity as well as excess voltages up to 45 V.

The integrated PWM input of the TLE 4242 G permits LED brightness regulation by pulse width modulation. Due to the high input impedance of the PWM input the LITIX™ Linear can be operated as a protected high side switch.

Type	Package
TLE 4242 G	PG-TO263-7-1

Circuit Description

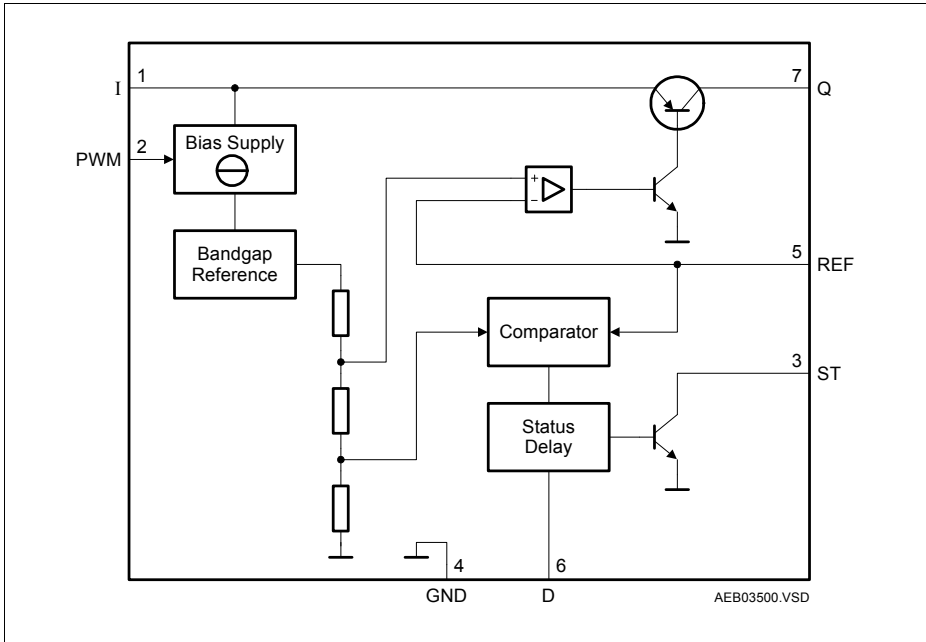

Figure 1 Block Diagram

An external shunt resistor in the ground path of the connected LEDs is used to sense the LED current. A regulation loop holds the voltage drop at the shunt resistor on a constant level of typ. 177 mV. Selecting the shunt resistance permits to adjust the appropriate constant current level. The typ. output current calculates

$$I_{Q, \text{typ}} = \frac{V_{\text{REF}}}{R_{\text{REF}}} \quad (1)$$

where V_{REF} is the reference voltage with a typical level of 177 mV (see [Page 10](#)). The equation applies in a range of $0.39 \Omega \leq R_{\text{REF}} \leq 1.8 \Omega$.

The output current is shown as a function of the reference resistance on [Page 10](#). With the PWM input the LED brightness can be regulated via duty cycle. Also PWM = L sets the TLE 4242 in sleep mode resulting in a very low current consumption of $\ll 1 \mu\text{A}$ typ. Due to the high impedance of the PWM input (see [“PWM Pin Input Current versus PWM Voltage” on Page 11](#)) the PWM pin can thus also be used as an enable input.

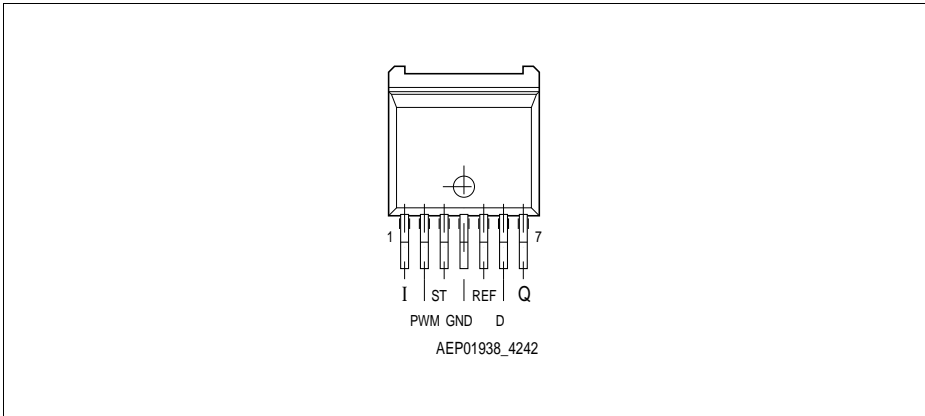

Figure 2 Pin Configuration (top view)

Table 1 Pin Definitions and Functions

Pin No.	Symbol	Function
1	I	Input ; block to GND directly at the IC with a 100 nF ceramic capacitor.
2	PWM	Pulse Width Modulation Input ; if not needed connect to I
3	ST	Status Output ; open collector output, connect to external pull-up resistor ($R_{pull-up} \geq 4.7 \text{ k}\Omega$).
4	GND	Ground
5	REF	Reference Input ; connect to shunt resistor.
6	D	Status Delay ; connect to GND via an optional capacitor to set status reaction delay. Leave open if no ST delay is needed.
7	Q	Output

Application Information

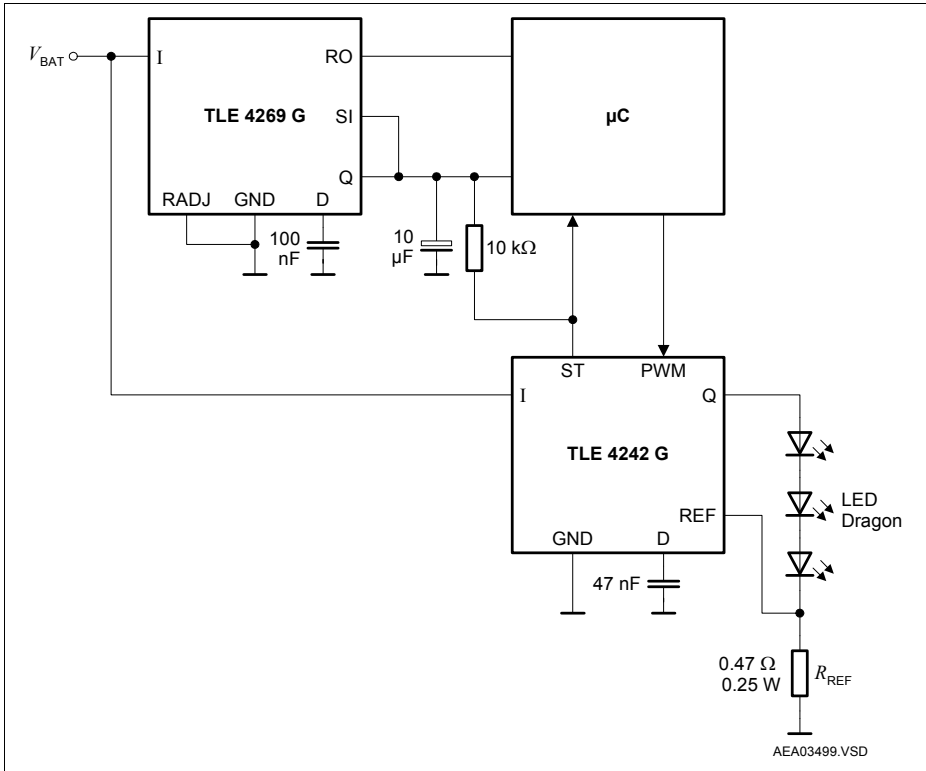

Figure 3 Application Circuit

Figure 3 shows a typical application with the TLE 4242 G LITIX™ Linear. The 3 LEDs are driven with an adequate supply current adjusted by the resistor R_{REF} . Thus brightness variations due to forward voltage spread of the LEDs are prevented. The luminosity spread arising from the LED production process can be compensated via software by an appropriate duty cycle applied to the PWM pin. Hence selection of the LEDs to forward voltage as well as to luminosity classes can be spared. The minimum supply voltage calculates as the sum of the LED forward voltages, the TLE 4242 G drop voltage (max. 0.7 V at a LED current of 300 mA) and the max. voltage drop at the shunt resistor R_{REF} of max. 185 mV.

The status output of the LITIX™ Linear (ST) detects an open load condition enabling to supervise correct LED function. A LED failure is detected if the voltage drop at the shunt resistor R_{REF} falls below typ. 25 mV. In this case the status output pin ST is set low after a delay time adjustable via an optional capacitor connected to the pin D.

The functionality of the ST and PWM as well as their timings are shown in **Figure 4**. The Status delay can be adjusted via the capacitor connected to the timing Pin D. The delay time scales in linear way with the capacitance C_D :

$$t_{STHL,typ} = \frac{C_D}{47 \text{ nF}} \times 10 \text{ ms} \quad t_{STLH,typ} = \frac{C_D}{47 \text{ nF}} \times 10 \text{ }\mu\text{s} \quad (2)$$

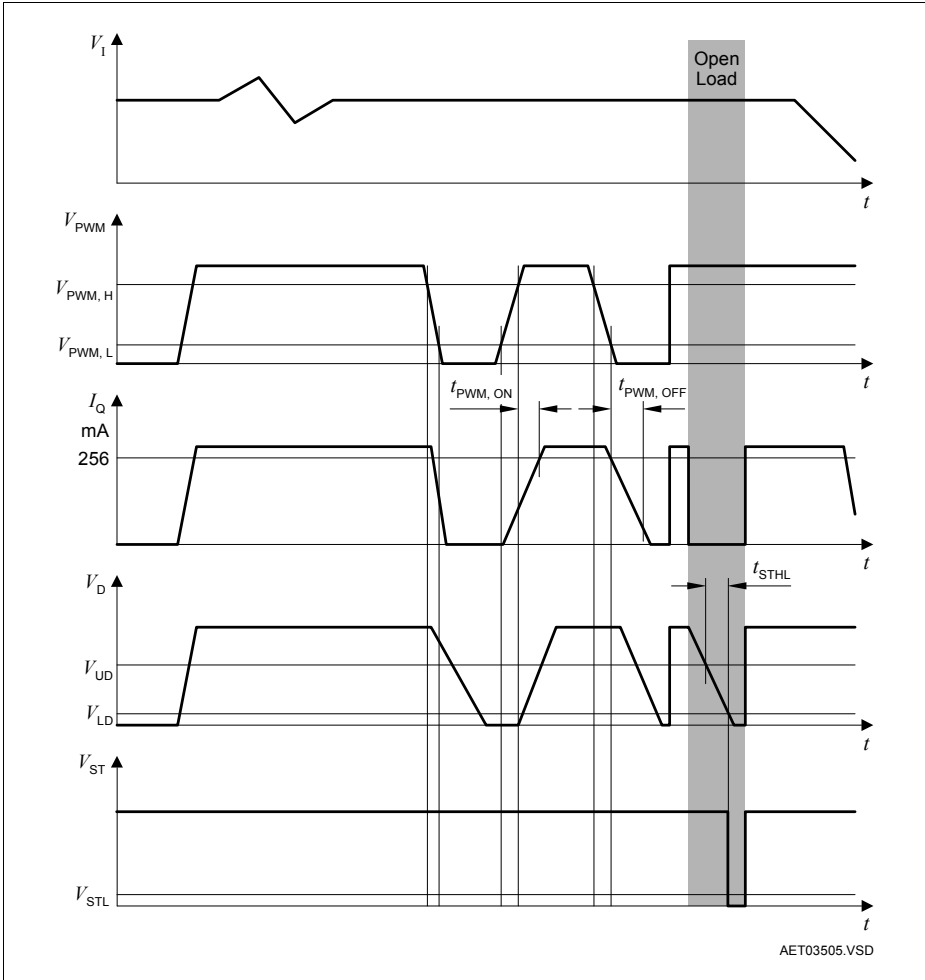

Figure 4 Function and Timing Diagram

Table 2 Absolute Maximum Ratings
 $-40\text{ °C} < T_j < 150\text{ °C}$

Parameter	Symbol	Limit Values		Unit	Remarks
		Min.	Max.		
Input					
Voltage	V_I	-42	45	V	–
Current	I_I	–	–	mA	internally limited
Output					
Voltage	V_Q	-1	40	V	–
Current	I_Q	–	–	mA	internally limited
Status Output					
Voltage	V_{ST}	-0.3	40	V	–
Current	I_{ST}	-5	5	mA	–
Status Delay					
Voltage	V_D	-0.3	7	V	–
Reference Input					
Voltage	V_{REF}	-1	16	V	–
Current	I_{REF}	-2	2	mA	–
Pulse Width Modulation Input					
Voltage	V_{PWM}	-40	40	V	–
Current	–	-1	1	mA	–
Temperatures					
Junction temperature	T_j	-40	150	°C	–
Storage temperature	T_{stg}	-50	150	°C	–
Thermal Resistances					
Junction ambient	R_{thja}	–	78	K/W	Footprint only ¹⁾
		–	52	K/W	300mm ² heat sink area
		–	39	K/W	600mm ² heat sink area
Junction case	R_{thjc}	–	3	K/W	–

1) Worst case regarding peak temperature; mounted on PCB FR4, 80 × 80 × 1.5 mm³, 35 μm Cu.

Note: Maximum ratings are absolute ratings; exceeding any one of these values may cause irreversible damage to the integrated circuit.

Table 3 Operating Range

Parameter	Symbol	Limit Values		Unit	Remarks
		Min.	Max.		
Input voltage	V_I	4.5	42	V	–
Status output voltage	V_{ST}	–	16	V	–
Status Delay capacitance	C_D	0	2.2	μF	–
PWM voltage	V_{PWM}	0	40	V	–
Junction temperature	T_j	-40	150	$^{\circ}\text{C}$	–
Reference resistor	R_{REF}	0	1.8	Ω	–

Table 4 Electrical Characteristics

$V_I = 13.5 \text{ V}$; $R_{REF} = 0.47 \text{ } \Omega$; $V_{PWM} \geq V_{PWM,H}$; $-40 \text{ } ^\circ\text{C} < T_j < 150 \text{ } ^\circ\text{C}$; all voltages with respect to ground; positive current defined flowing into pin; unless otherwise specified

Parameter	Symbol	Limit Values			Unit	Test Condition
		Min.	Typ.	Max.		
Current consumption off mode	I_{qOFF}	–	0.1	2	μA	PWM = L, $T_j < 85 \text{ } ^\circ\text{C}$
Current consumption	I_{qL}	–	12	22	mA	$V_Q = 6.6 \text{ V}$
Output						
Output current	I_Q	357	376	395	mA	$V_Q - V_{REF}^{(1)} = 6.6 \text{ V}$
		168	177	185	mA	$V_Q - V_{REF} = 6.6 \text{ V}$; $R_{REF} = 1.0 \text{ } \Omega$
		431	454	476	mA	$V_Q - V_{REF} = 6.6 \text{ V}$; $R_{REF} = 0.39 \text{ } \Omega$
		357	376	395	mA	$5.4 \text{ V} \leq V_Q - V_{REF} \leq 7.8 \text{ V}$; $9 \text{ V} \leq V_I \leq 16 \text{ V}$
Output current limit	I_{Qmax}	–	600	–	mA	$R_{REF} = 0 \text{ } \Omega$
Drop voltage	V_{dr}	–	0.35	0.7	V	$I_Q = 300 \text{ mA}$
PWM Input						
PWM high level	$V_{PWM,H}$	2.6	–	–	V	–
PWM low level	$V_{PWM,L}$	–	–	0.7	V	–
PWM input current high level	$I_{PWM,H}$	–	220	500	μA	$V_{PWM} = 5.0 \text{ V}$
PWM input current low level	$I_{PWM,L}$	-1	–	1	μA	$V_{PWM} = 0.0 \text{ V}$
Turn on delay time	$t_{PWM,ON}$	0	15	40	μs	70% of I_{Qnom} , see Figure 4
Turn off delay time	$t_{PWM,OFF}$	0	15	40	μs	30% of I_{Qnom} , see Figure 4

Table 4 Electrical Characteristics (cont'd)

$V_I = 13.5\text{ V}$; $R_{REF} = 0.47\ \Omega$; $V_{PWM} \geq V_{PWM,H}$; $-40\text{ }^\circ\text{C} < T_J < 150\text{ }^\circ\text{C}$; all voltages with respect to ground; positive current defined flowing into pin; unless otherwise specified

Parameter	Symbol	Limit Values			Unit	Test Condition
		Min.	Typ.	Max.		
Reference						
Reference Voltage	V_{REF}	168	177	185	mV	$0.39 < R_{REF} < 1.0\ \Omega$
Reference Input Current	I_{REF}	-1	0.1	1	μA	$V_{REF} = 180\text{ mV}$
Status Output						
Lower status switching threshold	V_{IQL}	15	25	–	mV	ST = L
Upper status switching threshold	V_{IQH}	–	30	40	mV	ST = H
Status low voltage	V_{STL}	–	–	0.4	V	$I_{ST} = 1.5\text{ mA}$
Leakage current	I_{STLK}	–	–	5	μA	$V_{ST} = 5.0\text{ V}$
Status Delay						
Status reaction delay	t_{STHL}	6	10	14	ms	$C_D = 47\text{ nF}$, ST H \rightarrow L
Status release delay	t_{STLH}	–	10	20	μs	$C_D = 47\text{ nF}$, ST L \rightarrow H

1) $V_Q - V_{REF}$ equals the forward voltage sum of the connected LEDs, see [Figure 3](#).

Typical Performance Characteristics

Output Current versus External Resistor

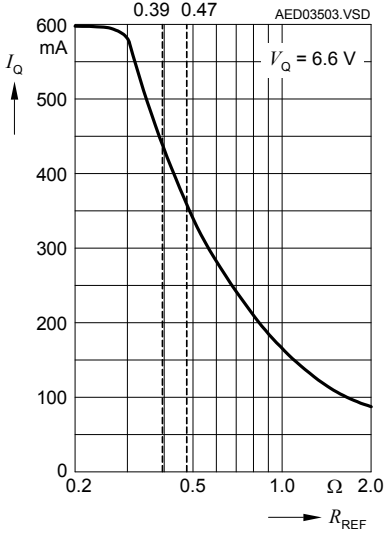

Reference Voltage versus Junction Temperature

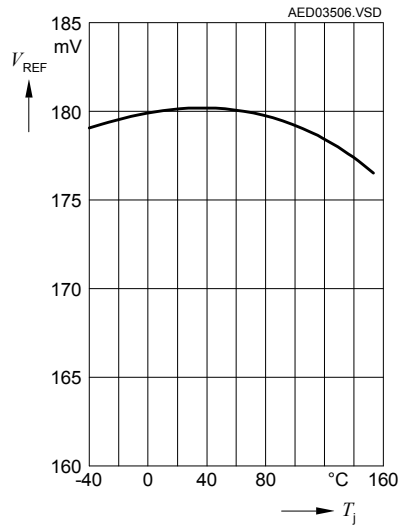

Output Current versus Supply Voltage

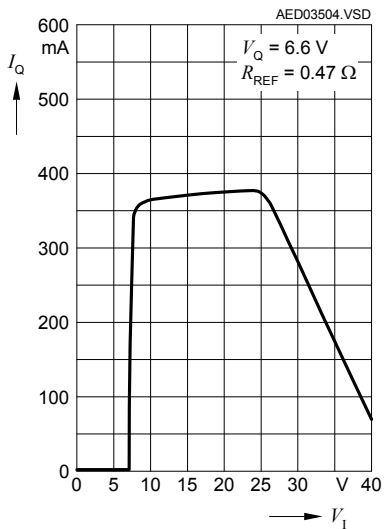

PWM Pin Input Current versus PWM Voltage

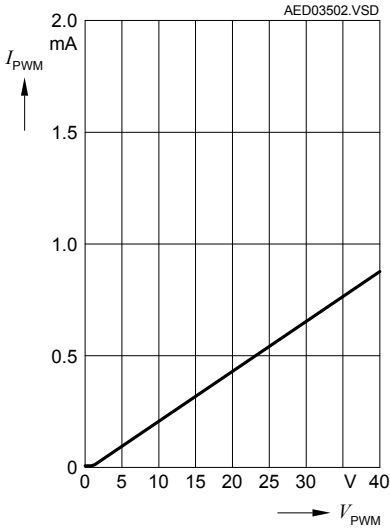

PWM Pin Input Current versus PWM Voltage

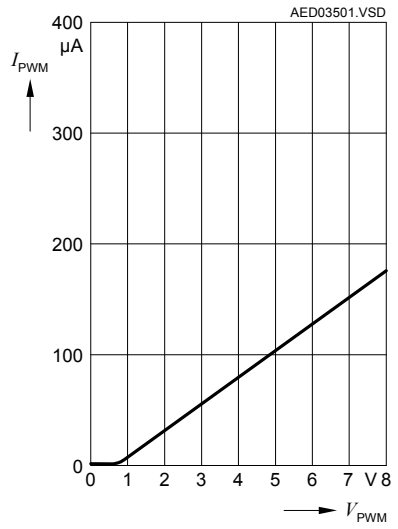

Package Outlines

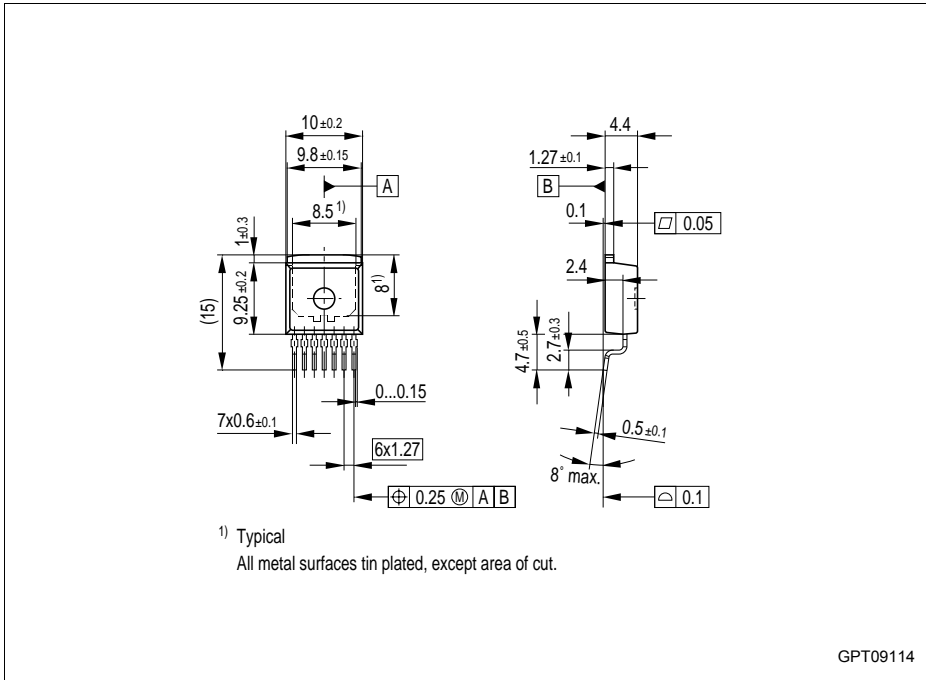

Figure 5 PG-TO263-7-1 (Plastic Transistor Single Outline)

Green Product (RoHS compliant)

To meet the world-wide customer requirements for environmentally friendly products and to be compliant with government regulations the device is available as a green product. Green products are RoHS-Compliant (i.e Pb-free finish on leads and suitable for Pb-free soldering according to IPC/JEDEC J-STD-020).

You can find all of our packages, sorts of packing and others in our Infineon Internet Page "Products": <http://www.infineon.com/products>.

SMD = Surface Mounted Device

Dimensions in mm

Revision History

Version	Date	Changes
Rev. 1.0	2004-01-01	Initial version
Rev. 1.1	2007-03-20	Initial version of RoHS-compliant derivate of TLE 4242 G Page 1 : AEC certified statement added Page 1 and Page 12 : RoHS compliance statement and Green product feature added Page 1 and Page 12 : Package changed to RoHS compliant version Legal Disclaimer updated

Edition 2007-03-20

**Published by
Infineon Technologies AG
81726 Munich, Germany**

**© 2007 Infineon Technologies AG
All Rights Reserved.**

Legal Disclaimer

The information given in this document shall in no event be regarded as a guarantee of conditions or characteristics. With respect to any examples or hints given herein, any typical values stated herein and/or any information regarding the application of the device, Infineon Technologies hereby disclaims any and all warranties and liabilities of any kind, including without limitation, warranties of non-infringement of intellectual property rights of any third party.

Information

For further information on technology, delivery terms and conditions and prices, please contact the nearest Infineon Technologies Office (www.infineon.com).

Warnings

Due to technical requirements, components may contain dangerous substances. For information on the types in question, please contact the nearest Infineon Technologies Office.







Infineon Technologies components may be used in life-support devices or systems only with the express written approval of Infineon Technologies, if a failure of such components can reasonably be expected to cause the failure of that life-support device or system or to affect the safety or effectiveness of that device or system. Life support devices or systems are intended to be implanted in the human body or to support and/or maintain and sustain and/or protect human life. If they fail, it is reasonable to assume that the health of the user or other persons may be endangered.

Looking for pricing, stock, or lifecycle information?

Click below to explore more details on WIN SOURCE:

-  [View TLE4242GATMA3 on WIN SOURCE](#)
-  [Infineon Technologies](#) Information

Optimize Your Supply Chain with WIN SOURCE Sol

-  Global Sourcing Solution
-  Obsolete Management
-  Cost Control Management
-  Shortage Management
-  Alternative Solution
-  Excess Inventory Management