



THE DATASHEET OF TIC226M



- 8 A RMS
- Glass Passivated Wafer
- 400 V to 800 V Off-State Voltage
- Max I_{GT} of 50 mA (Quadrants 1 - 3)

TO-220 PACKAGE
(TOP VIEW)

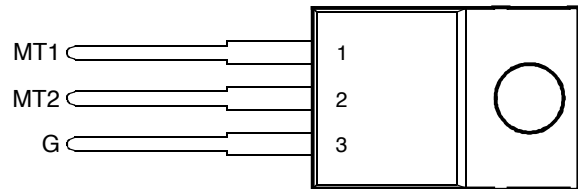

This series is currently available, but not recommended for new designs.



Pin 2 is in electrical contact with the mounting base.

MDC2ACA

absolute maximum ratings over operating case temperature (unless otherwise noted)

| RATING | | SYMBOL | VALUE | UNIT |
|---|---------|--------------|-------------|------|
| Repetitive peak off-state voltage (see Note 1) | TIC226D | V_{DRM} | 400 | V |
| | TIC226M | | 600 | |
| | TIC226S | | 700 | |
| | TIC226N | | 800 | |
| Full-cycle RMS on-state current at (or below) 85°C case temperature (see Note 2) | | $I_{T(RMS)}$ | 8 | A |
| Peak on-state surge current full-sine-wave at (or below) 25°C case temperature (see Note 3) | | I_{TSM} | 70 | A |
| Peak gate current | | I_{GM} | ±1 | A |
| Peak gate power dissipation at (or below) 85°C case temperature (pulse width ≤ 200 μs) | | P_{GM} | 2.2 | W |
| Average gate power dissipation at (or below) 85°C case temperature (see Note 4) | | $P_{G(AV)}$ | 0.9 | W |
| Operating case temperature range | | T_C | -40 to +110 | °C |
| Storage temperature range | | T_{stg} | -40 to +125 | °C |
| Lead temperature 1.6 mm from case for 10 seconds | | T_L | 230 | °C |

- NOTES: 1. These values apply bidirectionally for any value of resistance between the gate and Main Terminal 1.
 2. This value applies for 50-Hz full-sine-wave operation with resistive load. Above 85°C derate linearly to 110°C case temperature at the rate of 320 mA/°C.
 3. This value applies for one 50-Hz full-sine-wave when the device is operating at (or below) the rated value of on-state current. Surge may be repeated after the device has returned to original thermal equilibrium. During the surge, gate control may be lost.
 4. This value applies for a maximum averaging time of 20 ms.

electrical characteristics at 25°C case temperature (unless otherwise noted)

| PARAMETER | TEST CONDITIONS | | | MIN | TYP | MAX | UNIT |
|---|-------------------------------|----------------------|------------------------------|-----|------|------|------|
| I_{DRM} Repetitive peak off-state current | $V_D = \text{rated } V_{DRM}$ | $I_G = 0$ | $T_C = 110^\circ\text{C}$ | | | ±2 | mA |
| I_{GT} Gate trigger current | $V_{supply} = +12\text{ V}†$ | $R_L = 10\ \Omega$ | $t_{p(g)} > 20\ \mu\text{s}$ | | 6 | 50 | mA |
| | $V_{supply} = +12\text{ V}†$ | $R_L = 10\ \Omega$ | $t_{p(g)} > 20\ \mu\text{s}$ | | -12 | -50 | |
| | $V_{supply} = -12\text{ V}†$ | $R_L = 10\ \Omega$ | $t_{p(g)} > 20\ \mu\text{s}$ | | -10 | -50 | |
| | $V_{supply} = -12\text{ V}†$ | $R_L = 10\ \Omega$ | $t_{p(g)} > 20\ \mu\text{s}$ | | 25 | | |
| V_{GT} Gate trigger voltage | $V_{supply} = +12\text{ V}†$ | $R_L = 10\ \Omega$ | $t_{p(g)} > 20\ \mu\text{s}$ | | 0.7 | 2 | V |
| | $V_{supply} = +12\text{ V}†$ | $R_L = 10\ \Omega$ | $t_{p(g)} > 20\ \mu\text{s}$ | | -0.8 | -2 | |
| | $V_{supply} = -12\text{ V}†$ | $R_L = 10\ \Omega$ | $t_{p(g)} > 20\ \mu\text{s}$ | | -0.8 | -2 | |
| | $V_{supply} = -12\text{ V}†$ | $R_L = 10\ \Omega$ | $t_{p(g)} > 20\ \mu\text{s}$ | | 0.9 | 2 | |
| V_T On-state voltage | $I_T = \pm 12\text{ A}$ | $I_G = 50\text{ mA}$ | (see Note 5) | | ±1.5 | ±2.1 | V |

† All voltages are with respect to Main Terminal 1.

PRODUCT INFORMATION

APRIL 1971 - REVISED SEPTEMBER 2002
 Specifications are subject to change without notice.

electrical characteristics at 25°C case temperature (unless otherwise noted) (continued)

| PARAMETER | TEST CONDITIONS | | | MIN | TYP | MAX | UNIT |
|---|--|------------------------|---|---------|-----------|-----------|------------|
| I_H Holding current | $V_{supply} = +12 V \dagger$ $V_{supply} = -12 V \dagger$ | $I_G = 0$ $I_G = 0$ | Init' $I_{TM} = 100 mA$ Init' $I_{TM} = -100 mA$ | | 10 -6 | 30 -30 | mA |
| I_L Latching current | $V_{supply} = +12 V \dagger$ $V_{supply} = -12 V \dagger$ | (see Note 6) | | | | 50 -50 | mA |
| dv/dt Critical rate of rise of off-state voltage | $V_{DRM} = \text{Rated } V_{DRM}$ | $I_G = 0$ | $T_C = 110^\circ C$ | | ± 100 | | V/ μs |
| dv/dt _(c) Critical rise of commutation voltage | $V_{DRM} = \text{Rated } V_{DRM}$ | $I_{TRM} = \pm 12 A$ | $T_C = 85^\circ C$ (see figure 7) | ± 5 | | | V/ μs |

† All voltages are with respect to Main Terminal 1.

NOTES: 5. This parameter must be measured using pulse techniques, $t_p \leq 1 ms$, duty cycle $\leq 2 \%$. Voltage-sensing contacts separate from the current carrying contacts are located within 3.2 mm from the device body.

6. The triacs are triggered by a 15-V (open-circuit amplitude) pulse supplied by a generator with the following characteristics:
 $R_G = 100 \Omega$, $t_{p(g)} = 20 \mu s$, $t_r \leq 15 ns$, $f = 1 kHz$.

thermal characteristics

| PARAMETER | MIN | TYP | MAX | UNIT |
|---|-----|-----|------|--------------|
| $R_{\theta JC}$ Junction to case thermal resistance | | | 1.8 | $^\circ C/W$ |
| $R_{\theta JA}$ Junction to free air thermal resistance | | | 62.5 | $^\circ C/W$ |

TYPICAL CHARACTERISTICS

GATE TRIGGER CURRENT
vs

CASE TEMPERATURE

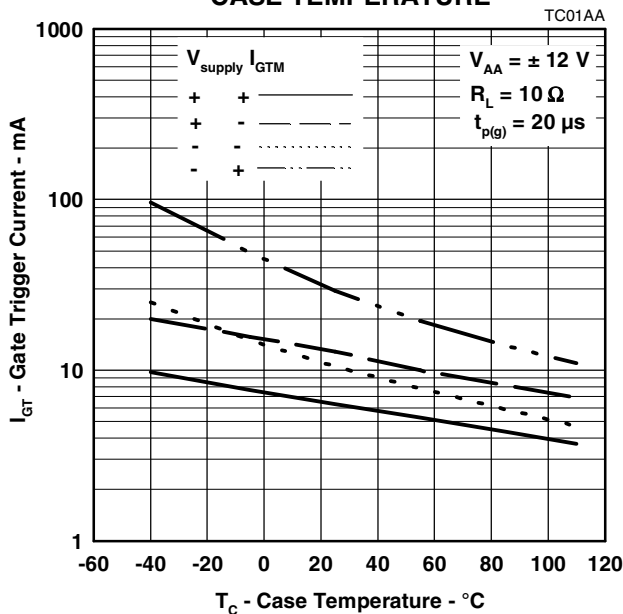

Figure 1.

GATE TRIGGER VOLTAGE
vs

CASE TEMPERATURE

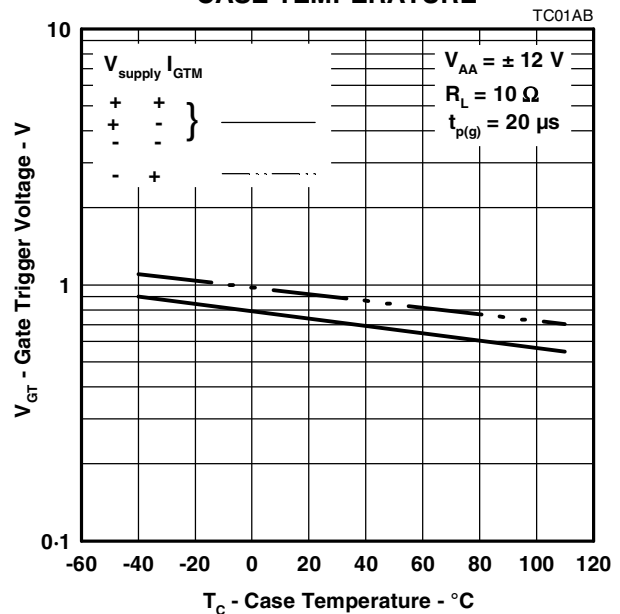
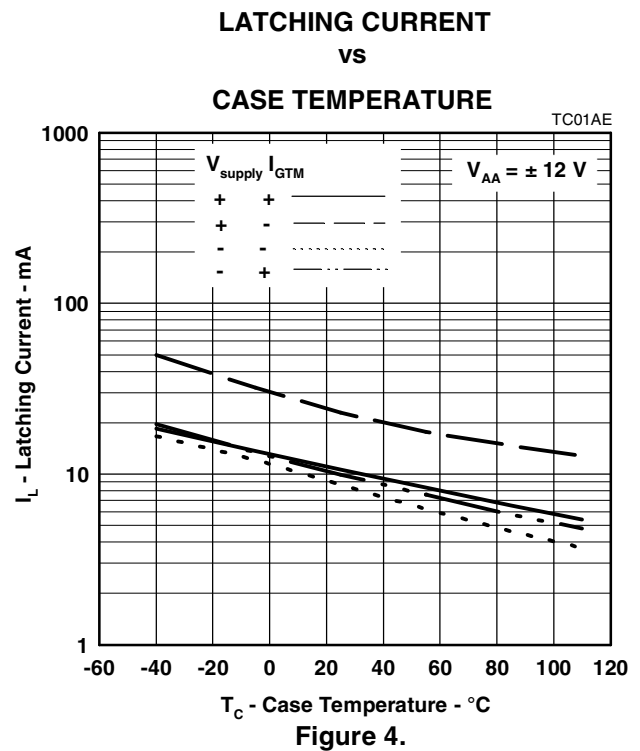
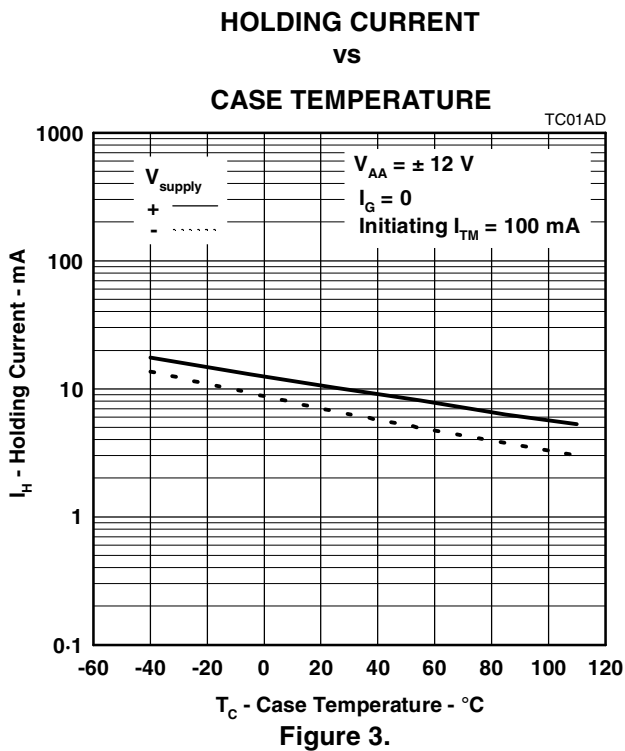

Figure 2.

PRODUCT INFORMATION

APRIL 1971 - REVISED SEPTEMBER 2002
Specifications are subject to change without notice.

TYPICAL CHARACTERISTICS



THERMAL INFORMATION

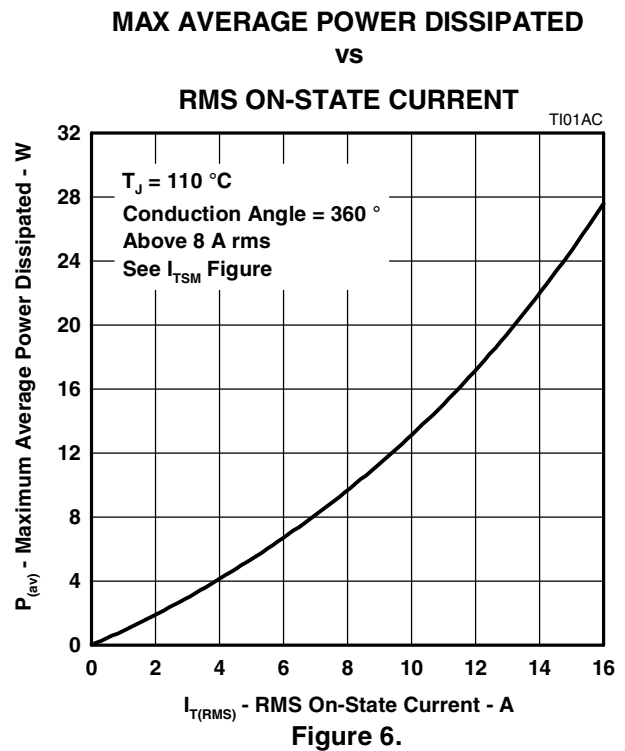
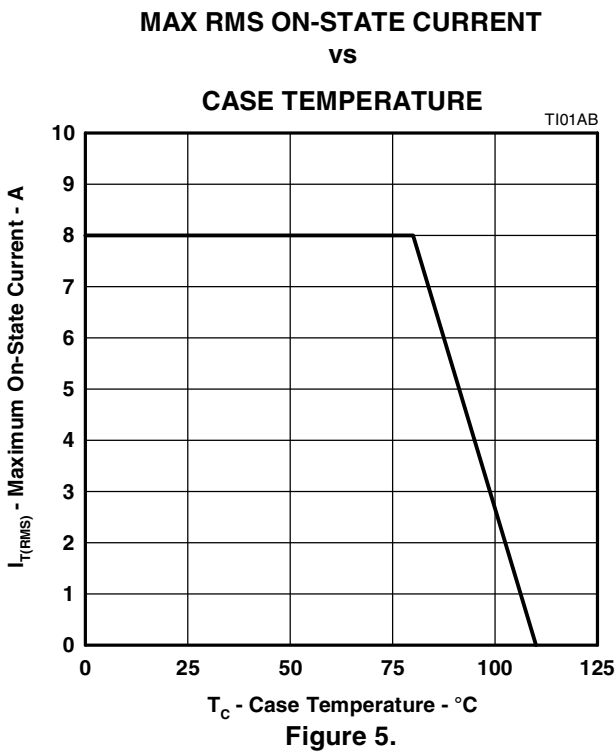

PRODUCT INFORMATION

APRIL 1971 - REVISED SEPTEMBER 2002
Specifications are subject to change without notice.

PARAMETER MEASUREMENT INFORMATION

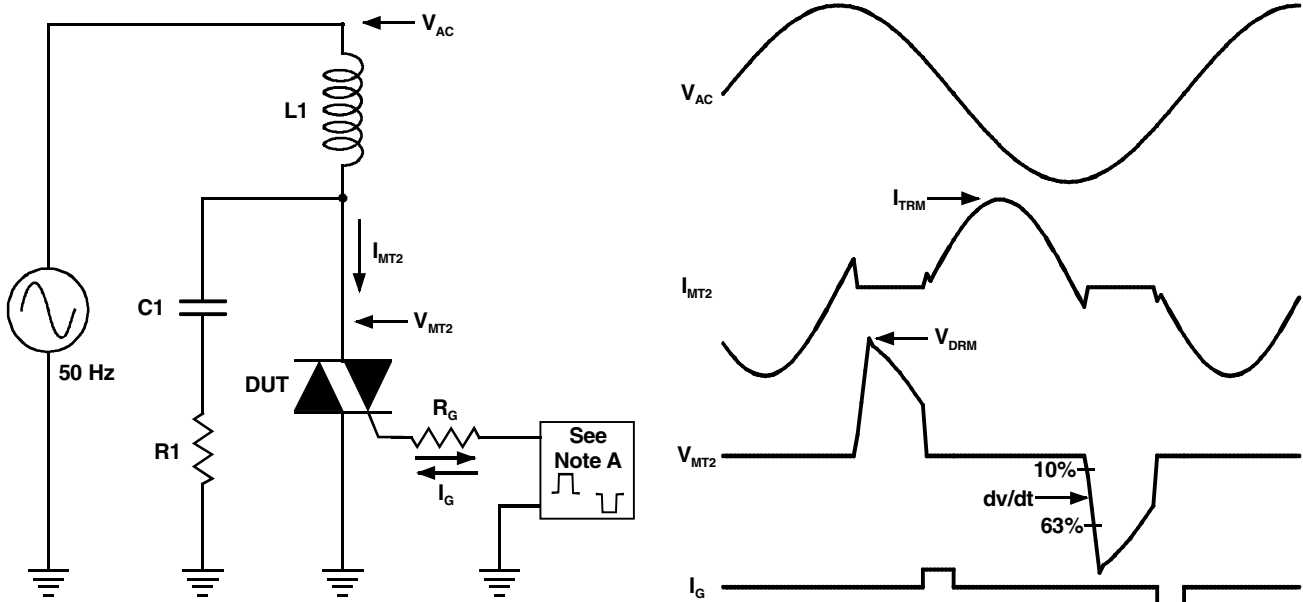

NOTE A: The gate-current pulse is furnished by a trigger circuit which presents essentially an open circuit between pulses. The pulse is timed so that the off-state-voltage duration is approximately 800 μ s.

PMC2AA



Figure 7.

PRODUCT INFORMATION

APRIL 1971 - REVISED SEPTEMBER 2002
Specifications are subject to change without notice.

Looking for pricing, stock, or lifecycle information?

Click below to explore more details on WIN SOURCE:

-  [View TIC226M on WIN SOURCE](#)
-  [Texas Instruments](#) Information

Optimize Your Supply Chain with WIN SOURCE Solutions

-  Global Sourcing Solution
-  Obsolete Management
-  Cost Control Management
-  Shortage Management
-  Alternative Solution
-  Excess Inventory Management