



THE DATASHEET OF
7B34-04-1



FEATURES

Amplifies, Protects, Filters, and interfaces input voltages from a wide variety of two and three-wire platinum, copper and nickel Resistor Temperature Detectors (RTDs).

Module provides a precision output of either +1 V to +5 V or 0 V to +10 V, linear with temperature.

All 7B34 series modules are mix-and-match and Hot Swappable.

APPLICATIONS

Industrial signal conditioning

Industrial signal amplification

Industrial signal filtering

PRODUCT OVERVIEW

The 7B Series of signal conditioners feature small size, low cost and a wide output voltage range for a variety of applications including process control and factory-floor environments. The single-channel 7B modules accept inputs from a range of transducers and are fully rated over the extended -40°C to $+85^{\circ}\text{C}$ industrial temperature range. All 7B Series modules are rated for a nominal power supply input of +24 VDC; and, for maximum flexibility, they will accept supply voltages in the +14 VDC to +35 VDC range. The input modules, with the exception of the 7B21, provide a high-level output voltage that is factory configured for either the +1 V to +5 V or 0 V to +10 V range. The 7B21 is a unity gain, isolated input module with an input/output range of +10V. Output modules are available that provide either isolated process current or isolated bipolar voltage output. Model 7B39 converts either a +1 V to +5 V input to a 4 to 20 mA output or a 0 V to +10 V input to a 0-20 mA output. The input/output ranges of the 7B39 are factory configured. The 7B22 is a unity gain module that provides an isolated +10V output signal. All modules have a universal pin-out and may be readily hot-swapped under full power without disrupting field wiring. Each module accepts analog transducer signals and transfers them to a process control or factory data collection system without the inherent noise, non-linearity, drift and extraneous voltages which frequently accompany the signals.

Rev. 0

Information furnished by Analog Devices is believed to be accurate and reliable. However, no responsibility is assumed by Analog Devices for its use, nor for any infringements of patents or other rights of third parties that may result from its use. Specifications subject to change without notice. No license is granted by implication or otherwise under any patent or patent rights of Analog Devices. Trademarks and registered trademarks are the property of their respective companies.

FUNCTIONAL BLOCK DIAGRAM

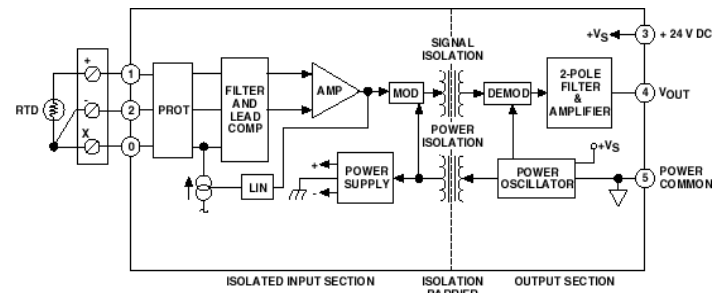

Figure 1. 7B34 Functional Block Diagram

The modules feature a maximum nonlinearity of $\pm 0.02\%$ and are factory calibrated to guarantee a maximum accuracy specification of $\pm 0.1\%$.

The 7B Series offers up to 1500 V rms continuous common mode voltage isolation and 120 V rms of field wiring input protection. The power supplies necessary to drive each of the individual module's input circuitry are internally isolated, enabling the 7B Series modules to offer true channel-to-channel isolation of the input signals.

The modules directly accept analog signals from thermocouples, RTDs, current loop powered transmitters, and other process control signals. The 7B Series modules amplify, linearize, isolate, protect and convert the transducer output signals to standardized analog inputs for high-level analog I/O subsystems. The 7B Series Subsystem consists of 19-inch rack-compatible hardware (model AC 1363), with universal mounting backplane and a family of plug-in (up to 16 per backplane) input and output signal conditioning modules. Four-, eight-, and sixteen-channel backplanes are available. Each backplane incorporates screw terminals for easy power connections and field wiring, and includes a 25-pin D-type connector for interfacing the high-level single-ended voltage outputs to the user's equipment. Gold-plated sockets are provided on each channel of the backplane to ensure the reliability of each module's electrical connection.

GENERAL DESCRIPTION

The 7B34 is a single-channel signal conditioning module that interfaces, amplifies and filters input voltages from a wide variety of two- and three-wire platinum, copper and nickel Resistor Temperature Detectors (RTDs) and provides a protected precision output of either +1 V to +5 V or 0 V to +10 V, linear with RTD temperature. Three-wire lead resistance compensation is provided and 2- or 3-wire RTDs may be used. RTD excitation current, and a predictable upscale open circuit indication provide a complete signal conditioning solution. Model 7B34 features a nonlinearity of $\pm 0.05\%$ maximum (Pt RTDs). To accurately measure low level signals in electrically noisy environments, 1500 V rms of galvanic transformer-based isolation with a common mode rejection (CMR) of 160 dB @ 50/60 Hz and a normal model rejection (NMR) of 60 dB @ 50/60 Hz are provided. Rated to operate with a nominal +24 VDC supply, Model 7B34 is mix-and-match and hot-swappable with other 7B Series input modules, so it can be inserted or removed from any socket in the same backplane without disturbing system power.

The three input pins of Model 7B34 are fully protected up to 120 V rms line voltage. A 250 μ A excitation current is provided to create an input voltage to the 7B34. This current also provides the upscale open circuit indication. A one-pole 3 Hz

filter preconditions the RTD signal prior to amplification, provided by a low drift input amplifier. Amplitude modulation is used to implement transformer isolation (1500 V rms input-to-output and power). Isolated front-end circuitry power is supplied by a DC/DC converter. The output section contains a two-pole low pass filter (-3 dB @ 3 Hz), a buffer amplifier and a power oscillator. The two-pole output filter and subsequent buffer ensures that a low noise, low impedance ($< 1\Omega$) signal is available at the output to drive loads to 2 k Ω minimum.



Figure 2

7B34 Models Available

Model	RTD Sensor(2- or 3-wire)	Input Range	Output Range	Nonlinearity(maximum)	Accuracy (maximum)
7B34-01-1	100 Ω Pt, $\alpha = 0.00385$	-100°C to +100°C	+1 V to +5 V	$\pm 0.05\%$ span	$\pm 0.15\%$ span
7B34-01-2	100 Ω Pt, $\alpha = 0.00385$	-100°C to +100°C	0 V to +10 V	$\pm 0.05\%$ span	$\pm 0.15\%$ span
7B34-02-1	100 Ω Pt, $\alpha = 0.00385$	0°C to +100°C	+1 V to +5 V	$\pm 0.05\%$ span	$\pm 0.2\%$ span
7B34-02-2	100 Ω Pt, $\alpha = 0.00385$	0°C to +100°C	0 V to +10 V	$\pm 0.05\%$ span	$\pm 0.2\%$ span
7B34-03-1	100 Ω Pt, $\alpha = 0.00385$	0°C to +200°C	+1 V to +5 V	$\pm 0.05\%$ span	$\pm 0.15\%$ span
7B34-03-2	100 Ω Pt, $\alpha = 0.00385$	0°C to +200°C	0 V to +10 V	$\pm 0.05\%$ span	$\pm 0.15\%$ span
7B34-04-1	100 Ω Pt, $\alpha = 0.00385$	0°C to +600°C	+1 V to +5 V	$\pm 0.05\%$ span	$\pm 0.1\%$ span
7B34-04-2	100 Ω Pt, $\alpha = 0.00385$	0°C to +600°C	0 V to +10 V	$\pm 0.05\%$ span	$\pm 0.1\%$ span
7B34-05-1	100 Ω Pt, $\alpha = 0.00385$	-50°C to +350°C	+1 V to +5 V	$\pm 0.05\%$ span	$\pm 0.1\%$ span
7B34-05-2	100 Ω Pt, $\alpha = 0.00385$	-50°C to +350°C	0 V to +10 V	$\pm 0.05\%$ span	$\pm 0.1\%$ span
7B34-N-01-1	120 Ω Ni, $\alpha = 0.00672$	0°C to +300°C	+1 V to +5 V	$\pm 0.12\%$ span	$\pm 0.3\%$ span
7B34-N-01-2	120 Ω Ni, $\alpha = 0.00672$	0°C to +300°C	0 V to +10 V	$\pm 0.12\%$ span	$\pm 0.3\%$ span
7B34-N-02-1	120 Ω Ni, $\alpha = 0.00672$	0°C to +200°C	+1 V to +5 V	$\pm 0.14\%$ span	$\pm 0.3\%$ span
7B34-N-02-2	120 Ω Ni, $\alpha = 0.00672$	0°C to +200°C	0 V to +10 V	$\pm 0.14\%$ span	$\pm 0.3\%$ span
7B34-C50-01-1	50 Ω Cu, $\alpha = 0.00214$	-100°C to +100°C	+1 V to +5 V	$\pm 0.10\%$ span	$\pm 0.15\%$ span
7B34-C50-02-1	50 Ω Cu, $\alpha = 0.00214$	0°C to +100°C	+1 V to +5 V	$\pm 0.02\%$ span	$\pm 0.15\%$ span
7B34-C50-06-1	50 Ω Cu, $\alpha = 0.00214$	-50°C to +200°C	+1 V to +5 V	$\pm 0.08\%$ span	$\pm 0.15\%$ span

7B34 Specifications

(typical @ +23°C ± 5 °C and $V_s = +24$ V dc)

Description	Model 7B34
Input Range¹	
RTD Types	100 Ω Platinum, 2-, 3-wire $\alpha = 0.00385$ 120 Ω Nickel, 2-, 3-wire, $\alpha = 0.00672$
Standard Temperature Ranges	Refer to Model Table
Custom Ranges	Not Available*
Output Range Options ($R_L > 2$ kΩ)	+1 V to +5 V or 0 V to +10 V
	Accuracy¹
Initial @ +25°C	Refer to Model Table
Nonlinearity ²	Refer to Model Table

Input Offset vs. Temperature	$\pm 1 \mu\text{V}/^\circ\text{C}$
Zero Suppression vs. Temperature	$\pm 0.002\% (R_z/R_{\text{span}})^3/^\circ\text{C}$
Span vs. Temperature	$\pm 60 \text{ ppm}/^\circ\text{C}$
Output Offset vs. Temperature	$\pm 0.002\% \text{ Span}/^\circ\text{C}$
Lead Resistance Effect	$\pm 0.02^\circ\text{C} / \Omega$
Output Noise	
5 MHz Bandwidth	10 mV peak
10 Hz to 100 kHz Bandwidth	0.4 mV rms
0.1 Hz to 10 Hz Bandwidth	0.6 μV peak
Bandwidth, -3 dB	3 Hz
Output Rise Time, 10% to 90% Span	250 ms
Common-Mode Voltage (CMV)	
Input-to-Output and Power	1500 V rms, continuous
Common Mode Rejection (CMR)	
Input-to-Output and Power @ 50/60 Hz	160 dB
Normal Mode Rejection @ 50/60 Hz	60 dB
Input Protection	120 V rms, continuous ± 35 V dc, continuous
Input Transient Protection	ANSI/IEEE C376.90.1-1989 IEEE-STD 472 IEC 255-4, Class II
Output Resistance	$< 1 \Omega$
Voltage Output Protection	Continuous Short to Ground
Power Supply	
Voltage Range, Operating	+14 V dc to +35 V dc
Current	+25 mA, maximum
Sensitivity	$\pm 0.0001\%/%$ of V_s
Mechanical Dimensions	1.663" x 2.11" x 0.563"(42.24 mm x 53.6 mm x 14.3 mm)
Weight	60 grams
Environmental	
Temperature Range	
Operating	-40°C to $+85^\circ\text{C}$
Storage	-40°C to $+85^\circ\text{C}$
Relative Humidity, 24 hours	0 to 90% @ $+60^\circ\text{C}$ noncondensing
ESD Sensitivity	IEC 801-2, Level 2
RFI Susceptibility	$\pm 0.5\%$ Span error @ 400 MHz, 5 Watt, 3 ft

Warm-up time required to meet specifications is approximately 10 minutes.

* Contact factory for OEM requirements.

¹Includes the combined effects of repeatability, hysteresis, and nonlinearity.

²Nonlinearity is calculated using best-fit straight line method.

³ R_z is the value of the RTD resistance at the lowest measurement point. R_{span} is the change in resistance over the measurement span.

Specifications subject to change without notice.

PIN CONFIGURATIONS AND FUNCTIONAL DESCRIPTIONS

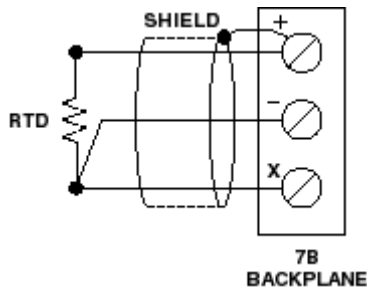

Figure 3 7B34 Input Field Connections

Table 1. Pin Function Descriptions—

Pin No.	Input Module Function	Output Module Function
0	SENSOR INPUT	NOT USED
1	INPUT HIGH	OUTPUT HIGH
2	INPUT LOW	OUTPUT LOW
3	POWER SUPPLY (DC)	POWER SUPPLY (DC)
4	OUTPUT VOLTAGE	INPUT VOLTAGE
5	OUTPUT & POWER COMMON	INPUT AND POWER COMMON

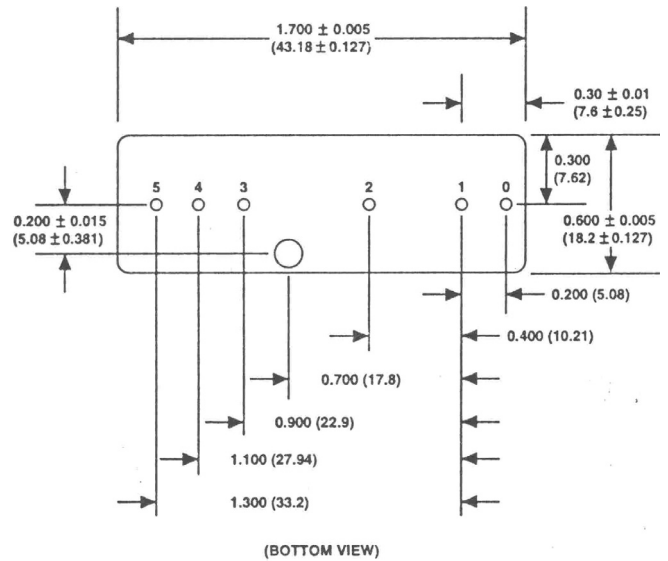

Figure 4 . Model 7B Series Module, with pin-out assignments.

ESD CAUTION

ESD (electrostatic discharge) sensitive device. Electrostatic charges as high as 4000 V readily accumulate on the human body and test equipment and can discharge without detection. Although this product features proprietary ESD protection circuitry, permanent damage may occur on devices subjected to high energy electrostatic discharges. Therefore, proper ESD precautions are recommended to avoid performance degradation or loss of functionality.



OUTLINE DIMENSIONS

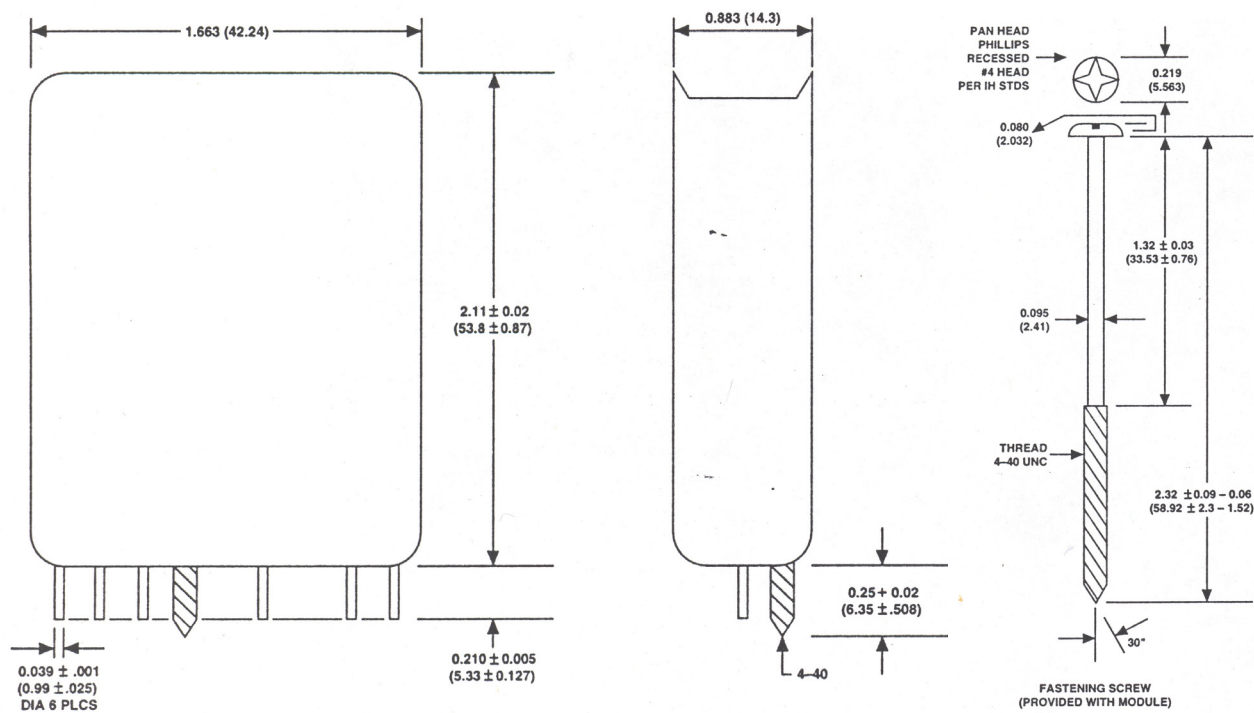



Figure 5. Outline Dimensions

NOTES

NOTES

Looking for pricing, stock, or lifecycle information?

Click below to explore more details on WIN SOURCE:

-  [View 7B34-04-1 on WIN SOURCE](#)
-  [Analog Devices Inc. Information](#)

Optimize Your Supply Chain with WIN SOURCE Solutions

-  Global Sourcing Solution
-  Obsolete Management
-  Cost Control Management
-  Shortage Management
-  Alternative Solution
-  Excess Inventory Management