



**THE DATASHEET OF  
74VCX2245MTCX**



## 74VCX2245

### Low Voltage Bidirectional Transceiver with 3.6V Tolerant Inputs and Outputs and 26Ω Series Resistors in B Outputs

#### General Description

The VCX2245 contains eight non-inverting bidirectional buffers with 3-STATE outputs and is intended for bus oriented applications. The T/R input determines the direction of data flow. The  $\overline{OE}$  input disables both the A and B ports by placing them in a high impedance state.

The 74VCX2245 is designed for low voltage (1.4V to 3.6V)  $V_{CC}$  applications with I/O compatibility up to 3.6V. The VCX2245 is also designed with 26Ω series resistance in the B Port outputs. This design reduces line noise in applications such as memory address drivers, clock drivers, and bus transceivers transmitters.

The 74VCX2245 is fabricated with an advanced CMOS technology to achieve high-speed operation while maintaining low CMOS power dissipation.

#### Features

- 1.4V - 3.6V  $V_{CC}$  supply operation
- 3.6V tolerant inputs and outputs
- 26Ω series resistors in B Port outputs
- Power-off high impedance inputs and outputs
- Supports Live Insertion and Withdrawal (Note 1)
- $t_{PD}$  (A to B)
  - 4.4 ns max for 3.0V to 3.6V  $V_{CC}$
- Static Drive ( $I_{OH}/I_{OL}$  B outputs):
  - ±12 mA @ 3.0V  $V_{CC}$
- Uses patented Quiet Series™ noise/EMI reduction circuitry
- Latchup performance exceeds JEDEC 78 conditions
- ESD performance:
  - Human body model > 2000V
  - Machine model > 200V
- Leadless DQFN Pb-Free package

**Note 1:** To ensure the high impedance state during power up and power down,  $\overline{OE}_n$  should be tied to  $V_{CC}$  through a pull up resistor. The minimum value of the resistor is determined by the current sourcing capability of the driver.

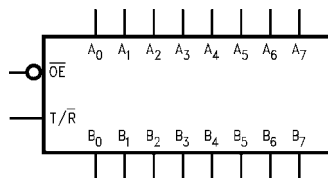
#### Ordering Code:

Order Number	Package Number	Package Description
74VCX2245WM	M20B	20-Lead Small Outline Integrated Circuit (SOIC), JEDEC MS-013, 0.300" Wide
74VCX2245BQX (Note 2)	MLP020B	Pb-Free 20-Terminal Depopulated Quad Very-Thin Flat Pack No Leads (DQFN), JEDEC MO-241, 2.5 x 4.5mm
74VCX2245MTC	MTC20	20-Lead Thin Shrink Small Outline Package (TSSOP), JEDEC MO-153, 4.4mm Wide

Devices also available in Tape and Reel. Specify by appending the suffix letter "X" to the ordering code.  
Pb-Free package per JEDEC J-STD-020B.

**Note 2:** DQFN package available in Tape and Reel only.

#### Logic Symbol



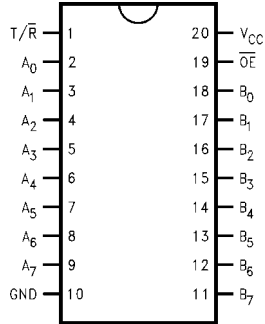
Quiet Series™ is a trademark of Fairchild Semiconductor Corporation.

#### Pin Descriptions

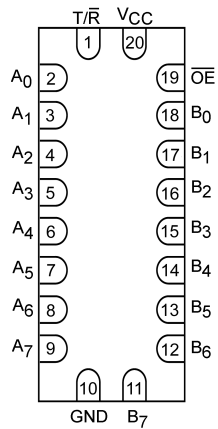
Pin Names	Description
$\overline{OE}$	Output Enable Input (Active LOW)
T/R	Transmit/Receive Input
A <sub>0</sub> -A <sub>7</sub>	Side A Inputs or 3-STATE Outputs
B <sub>0</sub> -B <sub>7</sub>	Side B Inputs or 3-STATE Outputs

### Connection Diagrams

Pin Assignments for SOIC and TSSOP



Pad Assignments for DQFN



(Top Through View)

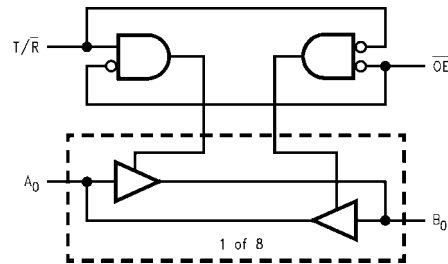
### Truth Table

Inputs		Outputs
$\overline{OE}$	$T/\overline{R}$	
L	L	Bus B <sub>0</sub> -B <sub>7</sub> Data to Bus A <sub>0</sub> -A <sub>7</sub>
L	H	Bus A <sub>0</sub> -A <sub>7</sub> Data to Bus B <sub>0</sub> -B <sub>7</sub>
H	X	HIGH Z State on A <sub>0</sub> -A <sub>7</sub> , B <sub>0</sub> -B <sub>7</sub> (Note 3)

H = HIGH Voltage Level  
 L = LOW Voltage Level  
 X = Immaterial  
 Z = High Impedance

**Note 3:** Unused bus terminals during HIGH Z State must be held HIGH or LOW.

### Logic Diagram



**Absolute Maximum Ratings**(Note 4)

Supply Voltage ( $V_{CC}$ )	-0.5V to +4.6V
DC Input Voltage ( $V_I$ )	-0.5V to +4.6V
DC Output Voltage ( $V_O$ )	
Outputs 3-STATE	-0.5V to +4.6V
Outputs Active (Note 5)	-0.5V to $V_{CC} + 0.5V$
DC Input Diode Current ( $I_{IK}$ ) $V_I < 0V$	-50 mA
DC Output Diode Current ( $I_{OK}$ )	
$V_O < 0V$	-50 mA
$V_O > V_{CC}$	+50 mA
DC Output Source/Sink Current ( $I_{OH}/I_{OL}$ )	$\pm 50$ mA
DC $V_{CC}$ or Ground Current	$\pm 100$ mA
Storage Temperature ( $T_{STG}$ )	-65°C to +150°C

**Recommended Operating Conditions** (Note 6)

Power Supply Voltage ( $V_{CC}$ )	
Operating	1.4V to 3.6V
Input Voltage	-0.3V to 3.6V
Output Voltage ( $V_O$ )	
Output in Active States	0V to $V_{CC}$
Output in 3-STATE	0V to 3.6V
Output Current in $I_{OH}/I_{OL}$ - A Outputs	
$V_{CC} = 3.0V$ to 3.6V	$\pm 24$ mA
$V_{CC} = 2.3V$ to 2.7V	$\pm 18$ mA
$V_{CC} = 1.65V$ to 2.3V	$\pm 6$ mA
$V_{CC} = 1.4V$ to 1.65V	$\pm 2$ mA
Output Current in $I_{OH}/I_{OL}$ - B Outputs	
$V_{CC} = 3.0V$ to 3.6V	$\pm 12$ mA
$V_{CC} = 2.3V$ to 2.7V	$\pm 8$ mA
$V_{CC} = 1.65V$ to 2.3V	$\pm 3$ mA
$V_{CC} = 1.4V$ to 1.65V	$\pm 1$ mA
Free Air Operating Temperature ( $T_A$ )	-40°C to +85°C
Minimum Input Edge Rate ( $\Delta t/\Delta V$ )	
$V_{IN} = 0.8V$ to 2.0V, $V_{CC} = 3.0V$	10 ns/V

**Note 4:** The Absolute Maximum Ratings are those values beyond which the safety of the device cannot be guaranteed. The device should not be operated at these limits. The parametric values defined in the Electrical Characteristics tables are not guaranteed at the Absolute Maximum Ratings. The "Recommended Operating Conditions" table will define the conditions for actual device operation.

**Note 5:**  $I_O$  Absolute Maximum Rating must be observed.

**Note 6:** Floating or unused inputs must be held HIGH or LOW.

**DC Electrical Characteristics**

Symbol	Parameter	Conditions	$V_{CC}$ (V)	Min	Max	Units
$V_{IH}$	HIGH Level Input Voltage		2.7 - 3.6 2.3 - 2.7 1.65 - 2.3 1.4 - 1.6	2.0 1.6 $0.65 \times V_{CC}$ $0.65 \times V_{CC}$		V
$V_{IL}$	LOW Level Input Voltage		2.7 - 3.6 2.3 - 2.7 1.65 - 2.3 1.4 - 1.6		0.8 0.7 $0.35 \times V_{CC}$ $0.35 \times V_{CC}$	V
$V_{OH}$	HIGH Level Output Voltage A Outputs	$I_{OH} = -100 \mu A$ $I_{OH} = -12$ mA $I_{OH} = -18$ mA $I_{OH} = -24$ mA	2.7 - 3.6 2.7 3.0 3.0	$V_{CC} - 0.2$ 2.2 2.4 2.2		V
		$I_{OH} = -100 \mu A$ $I_{OH} = -6$ mA $I_{OH} = -12$ mA $I_{OH} = -18$ mA	2.3 - 2.7 2.3 2.3 2.3	$V_{CC} - 0.2$ 2.0 1.8 1.7		
		$I_{OH} = -100 \mu A$ $I_{OH} = -8$ mA	1.65 - 2.3 1.65	$V_{CC} - 0.2$ 1.25		
		$I_{OH} = -100 \mu A$ $I_{OH} = -2$ mA	1.4 - 1.6 1.4	$V_{CC} - 0.2$ 1.05		

DC Electrical Characteristics (Continued)						
Symbol	Parameter	Conditions	V <sub>CC</sub> (V)	Min	Max	Units
V <sub>OH</sub>	HIGH Level Output Voltage B Outputs	I <sub>OH</sub> = -100 μA	2.7 - 3.6	V <sub>CC</sub> - 0.2		V
		I <sub>OH</sub> = -6 mA	2.7	2.2		
		I <sub>OH</sub> = -8 mA	3.0	2.4		
		I <sub>OH</sub> = -12 mA	3.0	2.2		
		I <sub>OH</sub> = -100 μA	2.3 - 2.7	V <sub>CC</sub> - 0.2		
		I <sub>OH</sub> = -4 mA	2.3	2.0		
		I <sub>OH</sub> = -6 mA	2.3	1.8		
		I <sub>OH</sub> = -8 mA	2.3	1.7		
		I <sub>OH</sub> = -100 μA	1.65 - 2.3	V <sub>CC</sub> - 0.2		
		I <sub>OH</sub> = -3 mA	1.65	1.25		
		I <sub>OH</sub> = -100 μA	1.4 - 1.6	V <sub>CC</sub> - 0.2		
		I <sub>OH</sub> = -1 mA	1.4	1.05		
V <sub>OL</sub>	LOW Level Output Voltage A Outputs	I <sub>OL</sub> = 100 μA	2.7 - 3.6		0.2	V
		I <sub>OL</sub> = 12 mA	2.7		0.4	
		I <sub>OL</sub> = 18 mA	3.0		0.4	
		I <sub>OL</sub> = 24 mA	3.0		0.55	
		I <sub>OL</sub> = 100 μA	2.3 - 2.7		0.2	
		I <sub>OL</sub> = 12 mA	2.3		0.4	
		I <sub>OL</sub> = 18 mA	2.3		0.6	
		I <sub>OL</sub> = 100 μA	1.65 - 2.3		0.2	
		I <sub>OL</sub> = 6 mA	1.65		0.3	
		I <sub>OL</sub> = 100 μA	1.4 - 1.6		0.2	
		I <sub>OL</sub> = 2 mA	1.4		0.35	
		V <sub>OL</sub>	LOW Level Output Voltage B Outputs	I <sub>OL</sub> = 100 μA	2.7 - 3.6	
I <sub>OL</sub> = 6 mA	2.7				0.4	
I <sub>OL</sub> = 8 mA	3.0				0.55	
I <sub>OL</sub> = 12 mA	3.0				0.8	
I <sub>OL</sub> = 100 μA	2.7 - 2.7				0.2	
I <sub>OL</sub> = 6 mA	2.3				0.4	
I <sub>OL</sub> = 8 mA	2.3				0.6	
I <sub>OL</sub> = 100 μA	1.65 - 2.3				0.2	
I <sub>OL</sub> = 3 mA	1.65				0.3	
I <sub>OL</sub> = 100 μA	1.4 - 1.6				0.2	
I <sub>OL</sub> = 1 mA	1.4				0.35	
I <sub>I</sub>	Input Leakage Current			0 ≤ V <sub>I</sub> ≤ 3.6V	1.4 - 3.6	
I <sub>OZ</sub>	3-STATE Output Leakage	0 ≤ V <sub>O</sub> ≤ 3.6V V <sub>I</sub> = V <sub>IH</sub> or V <sub>IL</sub>	1.4 - 3.6		±10	μA
I <sub>OFF</sub>	Power Off Leakage Current	0 ≤ (V <sub>I</sub> , V <sub>O</sub> ) ≤ 3.6V	0		10	μA
I <sub>CC</sub>	Quiescent Supply Current	V <sub>I</sub> = V <sub>CC</sub> or GND V <sub>CC</sub> ≤ (V <sub>I</sub> , V <sub>O</sub> ) ≤ 3.6V (Note 7)	1.4 - 3.6 1.4 - 3.6		20 ±20	μA
ΔI <sub>CC</sub>	Increase in I <sub>CC</sub> per Input	V <sub>IH</sub> = V <sub>CC</sub> - 0.6V	2.7 - 3.6		750	μA
<b>Note 7:</b> Outputs disabled or 3-STATE only.						

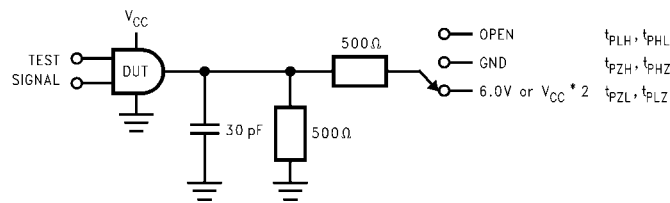
AC Electrical Characteristics (Note 8)							
Symbol	Parameter	Conditions	V <sub>CC</sub> (V)	T <sub>A</sub> = -40°C to +85°C		Units	Figure Number
				Min	Max		
t <sub>PHL</sub> t <sub>PLH</sub>	Propagation Delay B <sub>n</sub> to A <sub>n</sub>	C <sub>L</sub> = 30 pF, R <sub>L</sub> = 500Ω	3.3 ± 0.3	0.6	3.5	ns	Figures 1, 2
			2.5 ± 0.2	0.8	4.2		
	1.8 ± 0.15		1.5	8.4			
		C <sub>L</sub> = 15 pF, R <sub>L</sub> = 2kΩ	1.5 ± 0.1	1.0	16.8		Figures 5, 6
t <sub>PZL</sub> t <sub>PZH</sub>	Output Enable Time B <sub>n</sub> to A <sub>n</sub>	C <sub>L</sub> = 30 pF, R <sub>L</sub> = 500Ω	3.3 ± 0.3	0.6	4.5	ns	Figures 1, 3, 4
			2.5 ± 0.2	0.8	5.6		
			1.8 ± 0.15	1.5	9.8		
		C <sub>L</sub> = 15 pF, R <sub>L</sub> = 2kΩ	1.5 ± 0.1	1.0	19.6		Figures 5, 7, 8
t <sub>PLZ</sub> t <sub>PHZ</sub>	Output Disable Time B <sub>n</sub> to A <sub>n</sub>	C <sub>L</sub> = 30 pF, R <sub>L</sub> = 500Ω	3.3 ± 0.3	0.6	3.6	ns	Figures 1, 3, 4
			2.5 ± 0.2	0.8	4.0		
			1.8 ± 0.15	1.5	7.2		
		C <sub>L</sub> = 15 pF, R <sub>L</sub> = 2kΩ	1.5 ± 0.1	1.0	14.4		Figures 5, 7, 8
t <sub>OSHL</sub> t <sub>OSLH</sub>	Output to Output Skew (Note 9)	C <sub>L</sub> = 30 pF, R <sub>L</sub> = 500Ω	3.3 ± 0.3		0.5	ns	
			2.5 ± 0.2		0.5		
			1.8 ± 0.15		0.75		
		C <sub>L</sub> = 15 pF, R <sub>L</sub> = 2kΩ	1.5 ± 0.1		1.5		
t <sub>PHL</sub> t <sub>PLH</sub>	Propagation Delay A <sub>n</sub> to B <sub>n</sub>	C <sub>L</sub> = 30 pF, R <sub>L</sub> = 500Ω	3.3 ± 0.3	0.6	4.4	ns	Figures 1, 2
			2.5 ± 0.2	0.8	5.6		
			1.8 ± 0.15	1.5	9.8		
		C <sub>L</sub> = 15 pF, R <sub>L</sub> = 2kΩ	1.5 ± 0.1	1.0	19.6		Figures 5, 6
t <sub>PZL</sub> t <sub>PZH</sub>	Output Enable Time A <sub>n</sub> to B <sub>n</sub>	C <sub>L</sub> = 30 pF, R <sub>L</sub> = 500Ω	3.3 ± 0.3	0.6	5.0	ns	Figures 1, 3, 4
			2.5 ± 0.2	0.8	6.6		
			1.8 ± 0.15	1.5	9.8		
		C <sub>L</sub> = 15 pF, R <sub>L</sub> = 2kΩ	1.5 ± 0.1	1.0	19.6		Figures 5, 7, 8
t <sub>PLZ</sub> t <sub>PHZ</sub>	Output Disable Time A <sub>n</sub> to B <sub>n</sub>	C <sub>L</sub> = 30 pF, R <sub>L</sub> = 500Ω	3.3 ± 0.3	0.6	4.2	ns	Figures 1, 3, 4
			2.5 ± 0.2	0.8	4.7		
			1.8 ± 0.15	1.5	8.5		
		C <sub>L</sub> = 15 pF, R <sub>L</sub> = 2kΩ	1.5 ± 0.1	1.0	16.9		Figures 5, 7, 8

**Note 8:** For C<sub>L</sub> = 50 pF, add approximately 300 ps to the AC maximum specification.

**Note 9:** Skew is defined as the absolute value of the difference between the actual propagation delay for any two separate outputs of the same device. The specification applies to any outputs switching in the same direction, either HIGH-to-LOW (t<sub>OSHL</sub>) or LOW-to-HIGH (t<sub>OSLH</sub>).

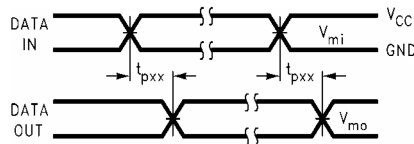
Dynamic Switching Characteristics					
Symbol	Parameter	Conditions	V <sub>CC</sub> (V)	T <sub>A</sub> = 25°C	Units
				Typical	
V <sub>OLP</sub>	Quiet Output Dynamic Peak V <sub>OL</sub> , B to A	C <sub>L</sub> = 30 pF, V <sub>IH</sub> = V <sub>CC</sub> , V <sub>IL</sub> = 0V	1.8	0.3	V
			2.5	0.7	
			3.3	1.0	
V <sub>OLV</sub>	Quiet Output Dynamic Peak V <sub>OL</sub> , A to B	C <sub>L</sub> = 30 pF, V <sub>IH</sub> = V <sub>CC</sub> , V <sub>IL</sub> = 0V	1.8	0.2	V
			2.5	0.45	
			3.3	0.65	
V <sub>OLV</sub>	Quiet Output Dynamic Valley V <sub>OL</sub> , B to A	C <sub>L</sub> = 30 pF, V <sub>IH</sub> = V <sub>CC</sub> , V <sub>IL</sub> = 0V	1.8	-0.3	V
			2.5	-0.7	
			3.3	-1.0	
V <sub>OLV</sub>	Quiet Output Dynamic Valley, V <sub>OL</sub> , A to B	C <sub>L</sub> = 30 pF, V <sub>IH</sub> = V <sub>CC</sub> , V <sub>IL</sub> = 0V	1.8	-0.2	V
			2.5	-0.45	
			3.3	-0.65	
V <sub>OHV</sub>	Quiet Output Dynamic Valley V <sub>OH</sub> , B to A	C <sub>L</sub> = 30 pF, V <sub>IH</sub> = V <sub>CC</sub> , V <sub>IL</sub> = 0V	1.8	1.3	V
			2.5	1.7	
			3.3	2.0	
V <sub>OHV</sub>	Quiet Output Dynamic Valley V <sub>OH</sub> , A to B	C <sub>L</sub> = 30 pF, V <sub>IH</sub> = V <sub>CC</sub> , V <sub>IL</sub> = 0V	1.8	1.5	V
			2.5	2.0	
			3.3	2.5	
Capacitance					
Symbol	Parameter	Conditions	T <sub>A</sub> = +25°C		Units
			Typical		
C <sub>IN</sub>	Input Capacitance	V <sub>I</sub> = 0V or V <sub>CC</sub> , V <sub>CC</sub> = 1.8V, 2.5V or 3.3V	6		pF
C <sub>I/O</sub>	Input/Output Capacitance	V <sub>I</sub> = 0V or V <sub>CC</sub> , V <sub>CC</sub> = 1.8V, 2.5V or 3.3V	7		pF
C <sub>PD</sub>	Power Dissipation Capacitance	V <sub>I</sub> = 0V or V <sub>CC</sub> , f = 10 MHz, V <sub>CC</sub> = 1.8V, 2.5V or 3.3V	20		pF

**AC Loading and Waveforms ( $V_{CC} 3.3V \pm 0.3V$  to  $1.8V \pm 0.15V$ )**

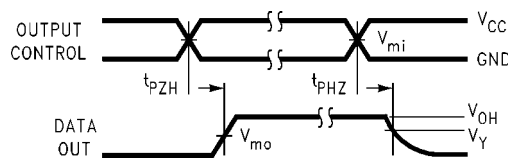


**FIGURE 1. AC Test Circuit**

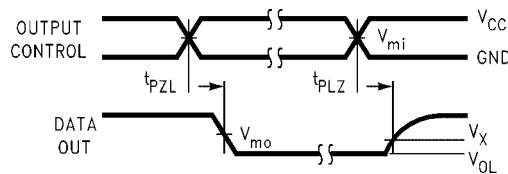
TEST	SWITCH
$t_{PLH}, t_{PHL}$	Open
$t_{PZL}, t_{PLZ}$	6V at $V_{CC} = 3.3 \pm 0.3V$ ; $V_{CC} \times 2$ at $V_{CC} = 2.5V \pm 0.2V; 1.8V \pm 0.15V$
$t_{PZH}, t_{PHZ}$	GND



**FIGURE 2. Waveform for Inverting and Non-inverting Functions**



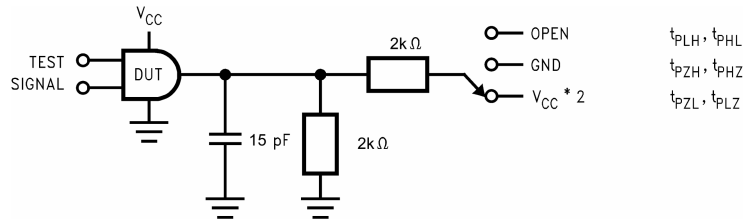
**FIGURE 3. 3-STATE Output High Enable and Disable Times for Low Voltage Logic**



**FIGURE 4. 3-STATE Output Low Enable and Disable Times for Low Voltage Logic**

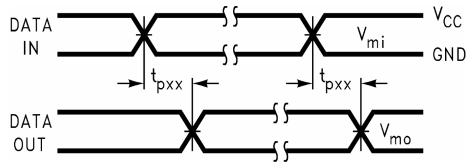
Symbol	$V_{CC}$		
	$3.3V \pm 0.3V$	$2.5V \pm 0.2V$	$1.8V \pm 0.15V$
$V_{mi}$	1.5V	$V_{CC}/2$	$V_{CC}/2$
$V_{mo}$	1.5V	$V_{CC}/2$	$V_{CC}/2$
$V_x$	$V_{OL} + 0.3V$	$V_{OL} + 0.15V$	$V_{OL} + 0.15V$
$V_y$	$V_{OH} - 0.3V$	$V_{OH} - 0.15V$	$V_{OH} - 0.15V$

**AC Loading and Waveforms ( $V_{CC} 1.5V \pm 0.1V$ )**

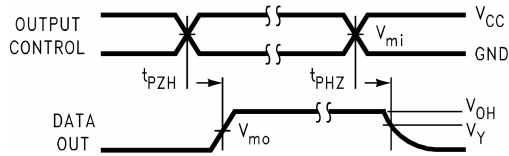


**FIGURE 5. AC Test Circuit**

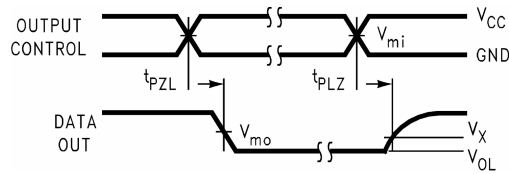
TEST	SWITCH
$t_{PLH}, t_{PHL}$	Open
$t_{PZL}, t_{PLZ}$	$V_{CC} \times 2$ at $V_{CC} = 1.5V \pm 0.1V$
$t_{PZH}, t_{PHZ}$	GND



**FIGURE 6. Waveform for Inverting and Non-inverting Functions**



**FIGURE 7. 3-STATE Output High Enable and Disable Times for Low Voltage Logic**



**FIGURE 8. 3-STATE Output Low Enable and Disable Times for Low Voltage Logic**

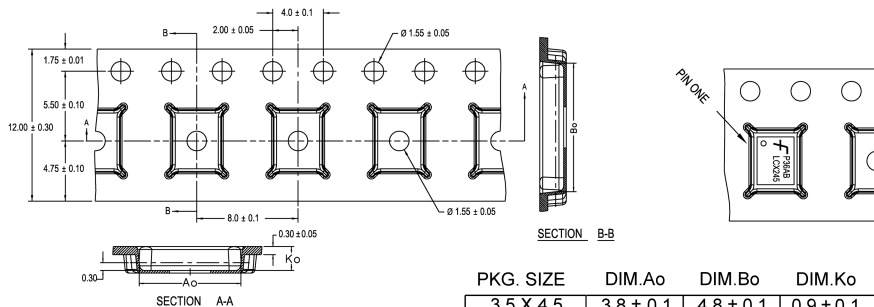
Symbol	$V_{CC}$
	$1.5V \pm 0.1V$
$V_{mi}$	$V_{CC}/2$
$V_{mo}$	$V_{CC}/2$
$V_x$	$V_{OL} + 0.1V$
$V_y$	$V_{OH} - 0.1V$

## Tape and Reel Specification

### Tape Format for DQFN

Package Designator	Tape Section	Number Cavities	Cavity Status	Cover Tape Status
BQX	Leader (Start End)	125 (typ)	Empty	Sealed
	Carrier	2500/3000	Filled	Sealed
	Trailer (Hub End)	75 (typ)	Empty	Sealed

### TAPE DIMENSIONS inches (millimeters)



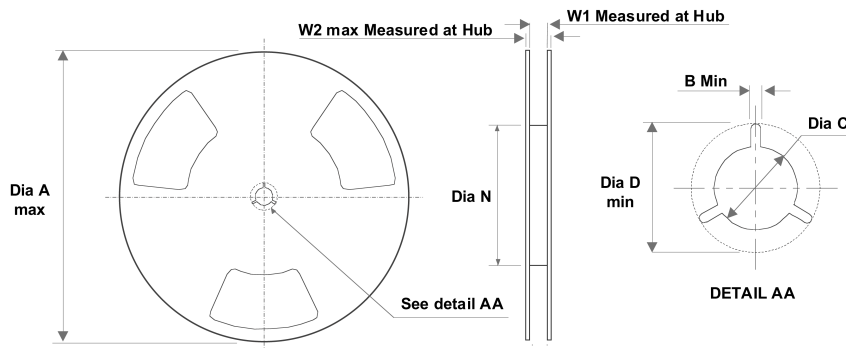
PKG. SIZE	DIM.Ao	DIM.Bo	DIM.Ko
3.5 X 4.5	3.8 ± 0.1	4.8 ± 0.1	0.9 ± 0.1
3.0 X 3.0	3.3 ± 0.1	3.3 ± 0.1	0.9 ± 0.1
2.5 X 4.5	2.8 ± 0.1	4.8 ± 0.1	0.9 ± 0.1
2.5 X 3.5	2.8 ± 0.1	3.8 ± 0.1	0.9 ± 0.1
2.5 X 3.0	2.8 ± 0.1	3.3 ± 0.1	0.9 ± 0.1
2.5 X 2.5	2.8 ± 0.1	2.8 ± 0.1	0.9 ± 0.1

DIMENSIONS ARE IN MILLIMETERS

NOTES: unless otherwise specified

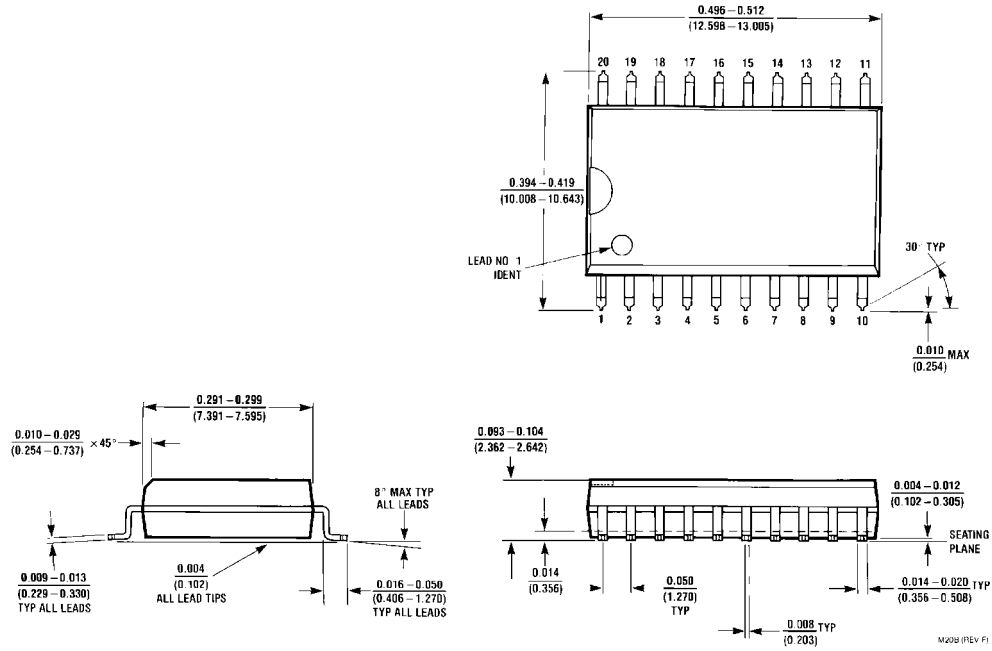
1. Cumulative pitch for feeding holes and cavities (chip pockets) not to exceed 0.008[0.20] over 10 pitch span.
2. Smallest allowable bending radius.
3. Thru hole inside cavity is centered within cavity.
4. Tolerance is  $\pm 0.002[0.05]$  for these dimensions on all 12mm tapes.
5. Ao and Bo measured on a plane 0.120[0.30] above the bottom of the pocket.
6. Ko measured from a plane on the inside bottom of the pocket to the top surface of the carrier.
7. Pocket position relative to sprocket hole measured as true position of pocket. Not pocket hole.
8. Controlling dimension is millimeter. Dimension in inches rounded.

### REEL DIMENSIONS inches (millimeters)



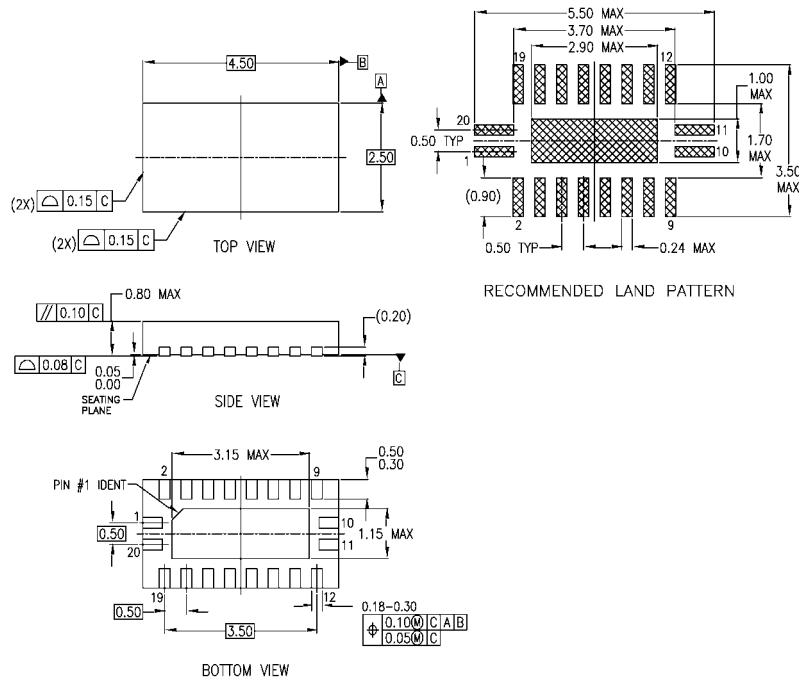
Tape Size	A	B	C	D	N	W1	W2
12 mm	13.0 (330)	0.059 (1.50)	0.512 (13.00)	0.795 (20.20)	7.008 (178)	0.488 (12.4)	0.724 (18.4)

**Physical Dimensions** inches (millimeters) unless otherwise noted



**20-Lead Small Outline Integrated Circuit (SOIC), JEDEC MS-013, 0.300" Wide  
Package Number M20B**

**Physical Dimensions** inches (millimeters) unless otherwise noted (Continued)



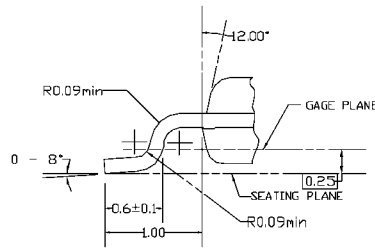
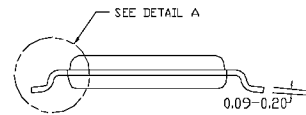
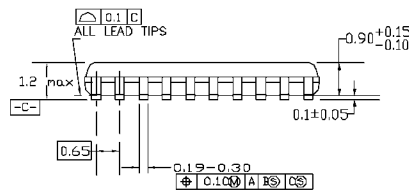
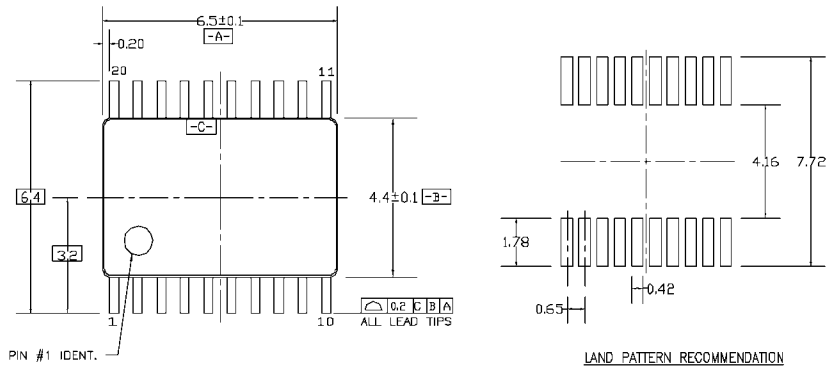
NOTES:

- A. CONFORMS TO JEDEC REGISTRATION MO-241, VARIATION AC
- B. DIMENSIONS ARE IN MILLIMETERS.
- C. DIMENSIONS AND TOLERANCES PER ASME Y14.5M, 1994

MLP020BrevA

**Pb-Free 20-Terminal Depopulated Quad Very-Thin Flat Pack No Leads (DQFN), JEDEC MO-241, 2.5 x 4.5mm Package Number MLP020B**

**Physical Dimensions** inches (millimeters) unless otherwise noted (Continued)



DIMENSIONS ARE IN MILLIMETERS

**NOTES:**

- A. CONFORMS TO JEDEC REGISTRATION MO-153, VARIATION AC, REF NOTE 6, DATE 7/93.
- B. DIMENSIONS ARE IN MILLIMETERS.
- C. DIMENSIONS ARE EXCLUSIVE OF BURRS, MOLDS FLASH, AND TIE BAR EXTRUSIONS.
- D. DIMENSIONS AND TOLERANCES PER ANSI Y14.5M, 1982.

MTC20REV D1

**20-Lead Thin Shrink Small Outline Package (TSSOP), JEDEC MO-153, 4.4mm Wide Package Number MTC20**

Fairchild does not assume any responsibility for use of any circuitry described, no circuit patent licenses are implied and Fairchild reserves the right at any time without notice to change said circuitry and specifications.

**LIFE SUPPORT POLICY**



FAIRCHILD'S PRODUCTS ARE NOT AUTHORIZED FOR USE AS CRITICAL COMPONENTS IN LIFE SUPPORT DEVICES OR SYSTEMS WITHOUT THE EXPRESS WRITTEN APPROVAL OF THE PRESIDENT OF FAIRCHILD SEMICONDUCTOR CORPORATION. As used herein:

1. Life support devices or systems are devices or systems which, (a) are intended for surgical implant into the body, or (b) support or sustain life, and (c) whose failure to perform when properly used in accordance with instructions for use provided in the labeling, can be reasonably expected to result in a significant injury to the user.
2. A critical component in any component of a life support device or system whose failure to perform can be reasonably expected to cause the failure of the life support device or system, or to affect its safety or effectiveness.

[www.fairchildsemi.com](http://www.fairchildsemi.com)

## Looking for pricing, stock, or lifecycle information?

Click below to explore more details on WIN SOURCE:

-  [View 74VCX2245MTCX on WIN SOURCE](#)
-  [Fairchild/ON Semiconductor Information](#)

## Optimize Your Supply Chain with WIN SOURCE Solutions

-  Global Sourcing Solution
-  Obsolete Management
-  Cost Control Management
-  Shortage Management
-  Alternative Solution
-  Excess Inventory Management