



**THE DATASHEET OF
74VCX16722MTDX**



74VCX16722

Low Voltage 22-Bit Register with 3.6V Tolerant Inputs and Outputs

General Description

The VCX16722 low voltage 22-bit register contains twenty-two non-inverting D-type flip-flops with 3-STATE outputs and is intended for bus oriented applications. The design has been optimized for use with JEDEC compliant 200 pin DIMM modules.

The 74VCX16722 is designed for low voltage (1.65V to 3.6V) V_{CC} applications with I/O capability up to 3.6V.

The 74VCX16722 is fabricated with an advanced CMOS technology to achieve high speed operation while maintaining low CMOS power dissipation.

Features

- 1.65V–3.6V V_{CC} supply operation
- 3.6V tolerant inputs and outputs
- t_{PD} (CLK to O_n)
 - 3.6ns max for 3.0V to 3.6V V_{CC}
 - 4.6ns max for 2.3V to 2.7V V_{CC}
 - 9.2ns max for 1.65V to 1.95V V_{CC}
- Power-down high impedance inputs and outputs
- Supports live insertion/withdrawal (Note 1)
- Meets JEDEC registered module specifications
- Static Drive (I_{OH}/I_{OL})
 - $\pm 24mA$ @ 3.0V
 - $\pm 18mA$ @ 2.3V
 - $\pm 6mA$ @ 1.65V
- Latchup performance exceeds 300 mA
- ESD performance:
 - Human body model > 2000V
 - Machine model >200V

Note 1: To ensure the high-impedance state during power up or power down, \overline{OE} should be tied to V_{CC} through a pull-up resistor; the minimum value of the resistor is determined by the current sourcing capability of the driver.

Ordering Code:

Order Number	Package Number	Package Description
74VCX16722MTD	MTD64	64-Lead Thin Shrink Small Outline Package (TSSOP), JEDEC MO-153, 6.1mm Wide

Devices also available in Tape and Reel. Specify by appending the suffix letter "X" to the ordering code.

74VCX16722 Low Voltage 22-Bit Register with 3.6V Tolerant Inputs and Outputs

Connection Diagram

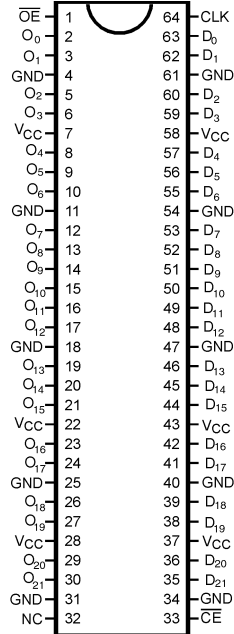

Pin Descriptions

Pin Names	Description
\overline{OE}	Output Enable Input (Active LOW)
\overline{CE}	Clock Enable Input (Active Low)
CLK	Clock Input
$D_0 - D_{21}$	Data Inputs
$O_0 - O_{21}$	3-STATE Outputs

Truth Table

CLK	\overline{CE}	\overline{OE}	D_n	O_n
X	X	H	X	Z
X	H	L	X	O_n
\uparrow	L	L	L	L
\uparrow	L	L	H	H
L or H	L	L	X	O_n

H = Logic HIGH
 L = Logic LOW
 X = Don't Care, but not floating
 Z = High Impedance
 O_n = Previous O_n before LOW-to-HIGH Clock Transition
 \uparrow = LOW-to-HIGH Clock Transition

Functional Description

The VCX16722 contains twenty-two D-type flip-flops with 3-STATE standard outputs. The twenty-two flip-flops will store the state of their individual D-type inputs that meet the setup and hold time requirements on the LOW-HIGH Clock (CLK) transition, when the Clock-Enable (\overline{CE}) is LOW. The 3-STATE standard outputs are controlled by the Output-Enable (\overline{OE}). When \overline{OE} is HIGH, the standard outputs are in high impedance mode but this does not interfere with entering new data into the flip-flops.

Logic Diagram

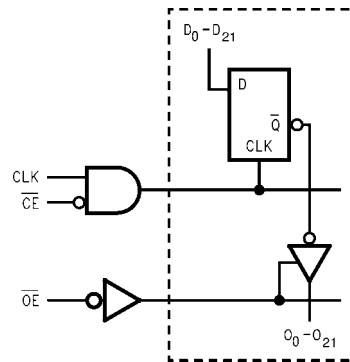

Absolute Maximum Ratings (Note 2)

Supply Voltage (V_{CC})	-0.5V to +4.6V
DC Input Voltage (V_I)	-0.5V to +4.6V
Output Voltage (V_O)	
Outputs 3-STATE	-0.5V to +4.6V
Outputs Active (Note 3)	-0.5V to $V_{CC} + 0.5V$
DC Input Diode Current (I_{IK}) $V_I < 0V$	-50 mA
DC Output Diode Current (I_{OK})	
$V_O < 0V$	-50 mA
$V_O > V_{CC}$	+50 mA
DC Output Source/Sink Current (I_{OH}/I_{OL})	± 50 mA
DC V_{CC} or Ground Current per Supply Pin (I_{CC} or Ground)	± 100 mA
Storage Temperature Range (T_{STG})	-65°C to +150°C

Recommended Operating Conditions (Note 4)

Power Supply	
Operating	1.65V to 3.6V
Data Retention Only	1.2V to 3.6V
Input Voltage	-0.3V to 3.6V
Output Voltage (V_O)	
Output in Active States	0V to V_{CC}
Output in 3-STATE	0V to 3.6V
Output Current in I_{OH}/I_{OL}	
$V_{CC} = 3.0V$ to 3.6V	± 24 mA
$V_{CC} = 2.3V$ to 2.7V	± 18 mA
$V_{CC} = 1.65V$ to 2.3V	± 6 mA
Free Air Operating Temperature (T_A)	-40°C to +85°C
Minimum Input Edge Rate ($\Delta t/\Delta V$)	
$V_{IN} = 0.8V$ to 2.0V, $V_{CC} = 3.0V$	10 ns/V

Note 2: The "Absolute Maximum Ratings" are those values beyond which the safety of the device cannot be guaranteed. The device should not be operated at these limits. The parametric values defined in the Electrical Characteristics tables are not guaranteed at the Absolute Maximum Ratings. The Recommended Operating Conditions tables will define the conditions for actual device operation.

Note 3: I_O Absolute Maximum Rating must be observed.

Note 4: Floating or unused pin (inputs or I/O's) must be held HIGH or LOW.

DC Electrical Characteristics (2.7V < V_{CC} ≤ 3.6V)

Symbol	Parameter	Conditions	V_{CC} (V)	Min	Max	Units
V_{IH}	HIGH Level Input Voltage		2.7-3.6	2.0		V
V_{IL}	LOW Level Input Voltage		2.7-3.6		0.8	V
V_{OH}	HIGH Level Output Voltage	$I_{OH} = -100 \mu A$	2.7-3.6	$V_{CC} - 0.2$		V
		$I_{OH} = -12 \text{ mA}$	2.7	2.2		
		$I_{OH} = -18 \text{ mA}$	3.0	2.4		
		$I_{OH} = -24 \text{ mA}$	3.0	2.2		
V_{OL}	LOW Level Output Voltage	$I_{OL} = 100 \mu A$	2.7-3.6		0.2	V
		$I_{OL} = 12 \text{ mA}$	2.7		0.4	
		$I_{OL} = 18 \text{ mA}$	3.0		0.4	
		$I_{OL} = 24 \text{ mA}$	3.0		0.55	
I_I	Input Leakage Current	$0V \leq V_I \leq 3.6V$	2.7-3.6		± 5.0	μA
I_{OZ}	3-STATE Output Leakage	$0V \leq V_O \leq 3.6V$	2.7-3.6		± 10	μA
		$V_I = V_{IH}$ or V_{IL}				
I_{OFF}	Power Off Leakage Current	$0V \leq (V_I, V_O) \leq 3.6V$	0		10	μA
I_{CC}	Quiescent Supply Current	$V_I = V_{CC}$ or GND	2.7-3.6		20	μA
		$V_{CC} \leq (V_I, V_O) \leq 3.6V$ (Note 5)		± 20		
ΔI_{CC}	Increase in I_{CC} per Input	$V_{IH} = V_{CC} - 0.6V$	2.7-3.6		750	μA

Note 5: Outputs disabled or 3-STATE only.

DC Electrical Characteristics ($2.3V \leq V_{CC} \leq 2.7V$)

Symbol	Parameter	Conditions	V_{CC} (V)	Min	Max	Units
V_{IH}	HIGH Level Input Voltage		2.3-2.7	1.6		V
V_{IL}	LOW Level Input Voltage		2.3-2.7		0.7	V
V_{OH}	HIGH Level Output Voltage	$I_{OH} = -100 \mu A$	2.3-2.7	$V_{CC} - 0.2$		V
		$I_{OH} = -6 \text{ mA}$	2.3	2.0		
		$I_{OH} = -12 \text{ mA}$	2.3	1.8		
		$I_{OH} = -18 \text{ mA}$	2.3	1.7		
V_{OL}	LOW Level Output Voltage	$I_{OL} = 100 \mu A$	2.3-2.7		0.2	V
		$I_{OL} = 12 \text{ mA}$	2.3		0.4	
		$I_{OL} = 18 \text{ mA}$	2.3		0.6	
I_I	Input Leakage Current	$0 \leq V_I \leq 3.6V$	2.3-2.7		± 5.0	μA
I_{OZ}	3-STATE Output Leakage	$0 \leq V_O \leq 3.6V$	2.3-2.7		± 10	μA
		$V_I = V_{IH}$ or V_{IL}				
I_{OFF}	Power Off Leakage Current	$0 \leq (V_I, V_O) \leq 3.6V$	0		10	μA
I_{CC}	Quiescent Supply Current	$V_I = V_{CC}$ or GND	2.3-2.7		20	μA
		$V_{CC} \leq (V_I, V_O) \leq 3.6V$ (Note 6)			± 20	

Note 6: Outputs disabled or 3-STATE only.

DC Electrical Characteristics ($1.65V \leq V_{CC} < 2.3V$)

Symbol	Parameter	Conditions	V_{CC} (V)	Min	Max	Units
V_{IH}	HIGH Level Input Voltage		1.65 - 2.3	$0.65 \times V_{CC}$		V
V_{IL}	LOW Level Input Voltage		1.65 - 2.3		$0.35 \times V_{CC}$	V
V_{OH}	HIGH Level Output Voltage	$I_{OH} = -100 \mu A$	1.65 - 2.3	$V_{CC} - 0.2$		V
		$I_{OH} = -6 \text{ mA}$	1.65	1.25		
V_{OL}	LOW Level Output Voltage	$I_{OL} = 100 \mu A$	1.65 - 2.3		0.2	V
		$I_{OL} = 6 \text{ mA}$	1.65		0.3	
I_I	Input Leakage Current	$0 \leq V_I \leq 3.6V$	1.65 - 2.3		± 5.0	μA
I_{OZ}	3-STATE Output Leakage	$0 \leq V_O \leq 3.6V$	1.65 - 2.3		± 10	μA
		$V_I = V_{IH}$ or V_{IL}				
I_{OFF}	Power Off Leakage Current	$0 \leq (V_I, V_O) \leq 3.6V$	0		10	μA
I_{CC}	Quiescent Supply Current	$V_I = V_{CC}$ or GND	1.65 - 2.3		20	μA
		$V_{CC} \leq (V_I, V_O) \leq 3.6V$ (Note 7)			± 20	

Note 7: Outputs disabled or 3-STATE only.

AC Electrical Characteristics (Note 8)								
Symbol	Parameter	$T_A = -40^\circ\text{C to } +85^\circ\text{C}, C_L = 30 \text{ pF}, R_L = 500\Omega$						Units
		$V_{CC} = 3.3V \pm 0.3V$		$V_{CC} = 2.5 \pm 0.2V$		$V_{CC} = 1.8 \pm 0.15V$		
		Min	Max	Min	Max	Min	Max	
f_{MAX}	Maximum Clock Frequency	250		200		100		MHz
t_{PHL}, t_{PLH}	Propagation Delay Clock to Bus	1.3	3.6	1.5	4.6	2.0	9.2	ns
t_{PZL}, t_{PZH}	Output Enable Time	0.6	3.5	0.8	4.5	1.5	9.0	ns
t_{PLZ}, t_{PHZ}	Output Disable Time	0.6	3.2	0.8	4.2	1.5	7.6	ns
t_S	Setup Time	2.0		2.0		3.0		ns
t_H	Hold Time	0.0		0.0		0.5		ns
t_W	Pulse Width	1.5		1.5		4.0		ns
t_{OSHL}	Output to Output Skew		0.5		0.5		0.75	ns
t_{OSLH}	(Note 9)							
<p>Note 8: For $C_L = 50 \text{ pF}$, add approximately 300 ps to the AC maximum specification.</p> <p>Note 9: Skew is defined as the absolute value of the difference between the actual propagation delay for any two separate outputs of the same device. The specification applies to any outputs switching in the same direction, either HIGH-to-LOW (t_{OSHL}) or LOW-to-HIGH (t_{OSLH}).</p>								
AC Electrical Characteristics Over Load (Note 10)								
Symbol	Parameter	$T_A = -0^\circ\text{C to } +70^\circ\text{C}, R_L = 500\Omega, V_{CC} = 3.3V \pm 0.3V$				Units		
		$C_L = 0 \text{ pF}$		$C_L = 50 \text{ pF}$				
		Min	Max	Min	Max			
t_{PHL}, t_{PLH}	Propagation Delay Clock to Bus	1.1	2.5	1.9	3.9	ns		
t_{PZL}, t_{PZH}	Output Enable Time	0.7	2.4	1.0	3.8	ns		
t_{PLZ}, t_{PHZ}	Output Disable Time	0.7	2.1	1.0	3.5	ns		
t_S	Setup Time	2.0		2.0		ns		
t_H	Hold Time	0.0		0.0		ns		
t_W	Pulse Width	1.5		1.5		ns		
<p>Note 10: This parameter is guaranteed by characterization but not tested.</p>								
Dynamic Switching Characteristics								
Symbol	Parameter	Conditions	V_{CC} (V)	$T_A = +25^\circ\text{C}$		Units		
				Typical				
V_{OLP}	Quiet Output Dynamic Peak V_{OL}	$C_L = 30 \text{ pF}, V_{IH} = V_{CC}, V_{IL} = 0V$	1.8	0.25		V		
			2.5	0.6				
			3.3	0.8				
V_{OLV}	Quiet Output Dynamic Valley V_{OL}	$C_L = 30 \text{ pF}, V_{IH} = V_{CC}, V_{IL} = 0V$	1.8	-0.25		V		
			2.5	-0.6				
			3.3	-0.8				
V_{OHV}	Quiet Output Dynamic Valley V_{OH}	$C_L = 30 \text{ pF}, V_{IH} = V_{CC}, V_{IL} = 0V$	1.8	1.5		V		
			2.5	1.9				
			3.3	2.2				

Capacitance

Symbol	Parameter	Conditions	$T_A = +25^\circ\text{C}$		Units
			Typical		
C_{IN}	Input Capacitance	$V_I = 0\text{V}$ or V_{CC} , $V_{CC} = 1.8\text{V}$, 2.5V , or 3.3V ,	3.5		pF
$C_{I/O}$	Input/Output Capacitance	$V_I = 0\text{V}$, or V_{CC} , $V_{CC} = 1.8\text{V}$, 2.5V or 3.3V	5.5		pF
C_{PD}	Power Dissipation Capacitance	$V_I = 0\text{V}$ or V_{CC} , $f = 10\text{ MHz}$, $V_{CC} = 1.8\text{V}$, 2.5V or 3.3V	13		pF

$I_{OH} - V_{OH}$ Characteristics

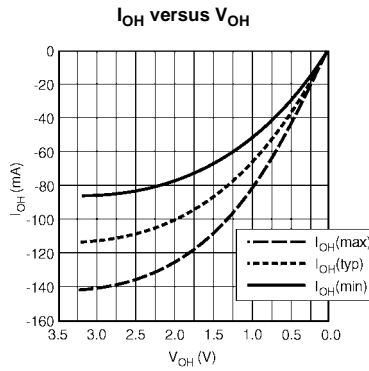

FIGURE 1. Characteristics for Output - Pull Up Driver

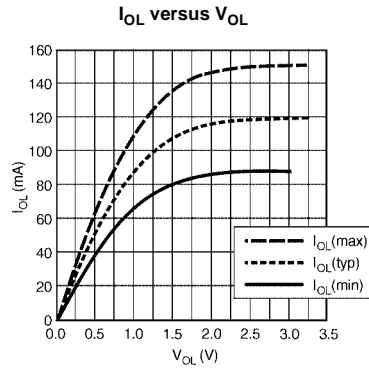

FIGURE 2. Characteristics for Output - Pull Down Driver

AC Loading and Waveforms

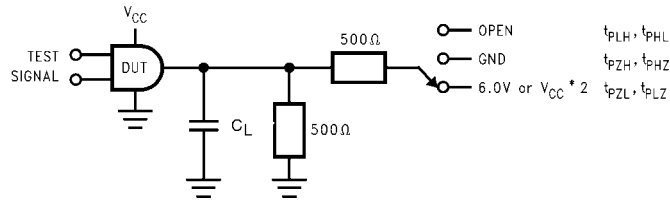

FIGURE 3. AC Test Circuit

TEST	SWITCH
t_{PLH}, t_{PHL}	Open
t_{PZL}, t_{PLZ}	6V at $V_{CC} = 3.3 \pm 0.3V$; $V_{CC} \times 2$ at $V_{CC} = 2.5 \pm 0.2V$; 1.8V to $\pm 0.15V$
t_{PZH}, t_{PHZ}	GND

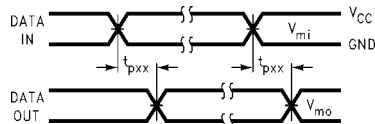

FIGURE 4. Waveform for Inverting and Non-inverting Functions
 $t_r = t_f \leq 2.0ns, 10\% \text{ to } 90\%$

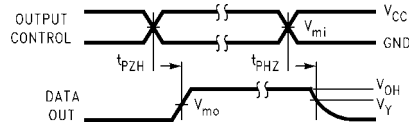

FIGURE 5. 3-STATE Output High Enable and Disable Times for Low Voltage Logic
 $t_r = t_f \leq 2.0ns, 10\% \text{ to } 90\%$

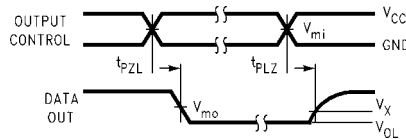
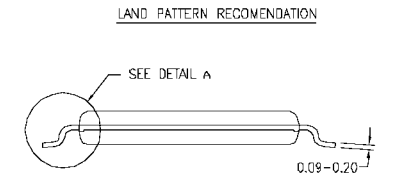
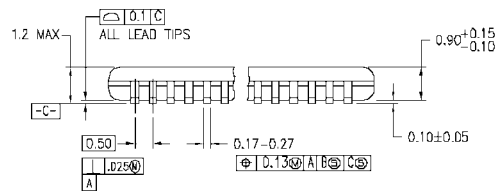
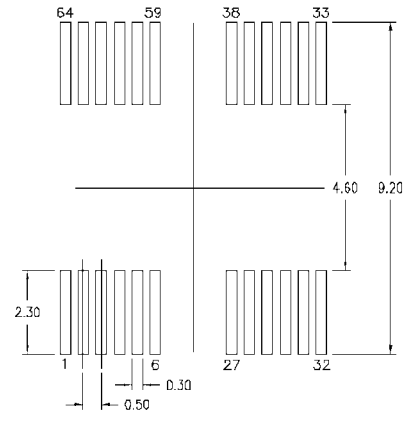
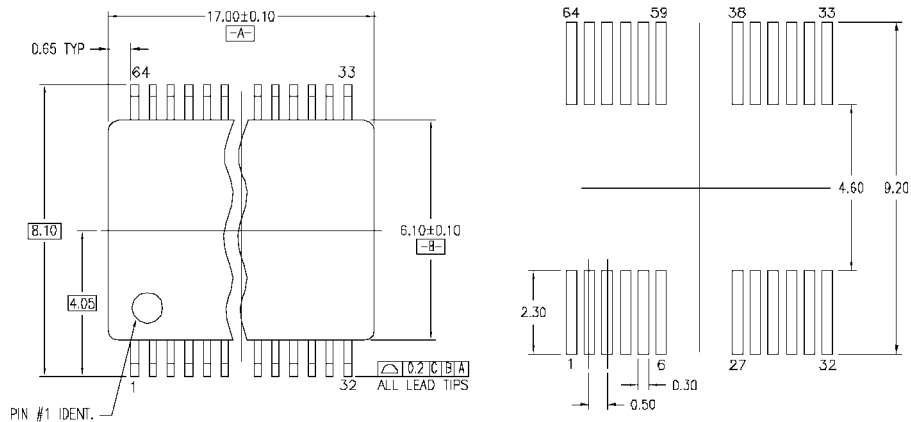

FIGURE 6. 3-STATE Output Low Enable and Disable Times for Low Voltage Logic
 $t_r = t_f \leq 2.0ns, 10\% \text{ to } 90\%$

Symbol	V_{CC}		
	$3.3V \pm 0.3V$	$2.5V \pm 0.2V$	$1.8 \pm 0.15V$
V_{mi}	1.5V	$V_{CC}/2$	$V_{CC}/2$
V_{mo}	1.5V	$V_{CC}/2$	$V_{CC}/2$
V_x	$V_{OL} + 0.3V$	$V_{OL} + 0.15V$	$V_{OL} + 0.15V$
V_y	$V_{OH} - 0.3V$	$V_{OH} - 0.15V$	$V_{OH} - 0.15V$

Physical Dimensions inches (millimeters) unless otherwise noted



DIMENSIONS ARE IN MILLIMETERS

NOTES:

- A. CONFORMS TO JEDEC REGISTRATION MO-153, VARIATION EF, REF NOTE 6, DATE 7/93.
- B. DIMENSIONS ARE IN MILLIMETERS.
- C. DIMENSIONS ARE EXCLUSIVE OF BURRS, MOLD FLASH, AND THE BAR EXTRUSIONS.
- D. DIMENSIONS AND TOLERANCES PER ANSI Y14.5M, 1982.

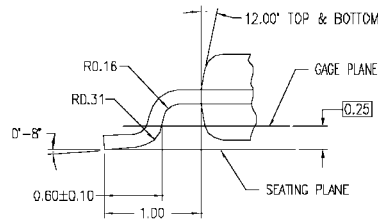

DETAIL A

MTD64REVB

64-Lead Thin Shrink Small Outline Package (TSSOP), JEDEC MO-153, 6.1mm Wide Package Number MTD64

Fairchild does not assume any responsibility for use of any circuitry described, no circuit patent licenses are implied and Fairchild reserves the right at any time without notice to change said circuitry and specifications.

LIFE SUPPORT POLICY

FAIRCHILD'S PRODUCTS ARE NOT AUTHORIZED FOR USE AS CRITICAL COMPONENTS IN LIFE SUPPORT DEVICES OR SYSTEMS WITHOUT THE EXPRESS WRITTEN APPROVAL OF THE PRESIDENT OF FAIRCHILD SEMICONDUCTOR CORPORATION. As used herein:

1. Life support devices or systems are devices or systems which, (a) are intended for surgical implant into the body, or (b) support or sustain life, and (c) whose failure to perform when properly used in accordance with instructions for use provided in the labeling, can be reasonably expected to result in a significant injury to the user.
2. A critical component in any component of a life support device or system whose failure to perform can be reasonably expected to cause the failure of the life support device or system, or to affect its safety or effectiveness.

www.fairchildsemi.com

Looking for pricing, stock, or lifecycle information?

Click below to explore more details on WIN SOURCE:

- ⊖ [View 74VCX16722MTDX on WIN SOURCE](#)
- ⊖ [Fairchild/ON Semiconductor Information](#)

Optimize Your Supply Chain with WIN SOURCE Solutions

- ✓ Global Sourcing Solution
- ✓ Obsolete Management
- ✓ Cost Control Management
- ✓ Shortage Management
- ✓ Alternative Solution
- ✓ Excess Inventory Management