

Overview

KOCAP Polymer Capacitors

The KEMET Organic Capacitor (KO-CAP) is a solid electrolytic capacitor with a conductive polymer cathode capable of delivering very low ESR and improved capacitance retention at high frequencies. KO-CAP combines the low ESR of multilayer ceramic, the high capacitance of aluminum electrolytic and the volumetric efficiency of tantalum into a single surface mount package. Unlike liquid electrolyte-based capacitors, KO-CAP has a very long operational life and high ripple current capabilities.

The T52X/T530 provides the widest range of voltages, capacitance and case size options in the KO-CAP family and is suitable for general purpose DC applications for up to 48 volt DC voltage rails.

Benefits

- ESR values down to 5 mOhms
- Stable capacitance across temperature and voltage
- No aging effects
- High ripple handling
- Volumetrically efficient
- High frequency capacitance retention
- 100% accelerated steady state aging
- 100% surge current tested
- Halogen-free epoxy/RoHS compliant

Applications

Typical applications include DC/DC converters, audio/sound circuits (mobile phone and base stations, smart phones, MP3 players), power supply inputs, portable electronics (notebook PCs, displays, SSDs, HDDs and USBs, digital cameras, GPS navigation systems, WiFi modules), telecommunications, consumer electronics (analytical and test equipment, high speed servers), high voltage applications such as 12 V to 48 V power input rails, densely populated circuits with space restrictions, microprocessor decoupling and high ripple current applications.



Environmental Compliance

- RoHS Compliant (6/6) according to Directive 2002/95/EC when ordered with 100% Sn, Ni-Pd-Au or non-magnetic 100% Sn solder
- Halogen-free
- Epoxy compliant with UL94 V-0

K-SIM

For a detailed analysis of specific part numbers, please visit ksim.kemet.com to access KEMET's K-SIM software. KEMET K-SIM is designed to simulate behavior of components with respect to frequency, ambient temperature, and DC bias levels.

Series Reference Selection

Series		Voltage Range		Temperature Rating			Special Features	
		< 1 V to 9 V Applications	12 V to 48 V Applications	85°C Rated	105°C Rated	125°C Rated	Miniature Size	Low ESL
T520	Standard	X	*	X**	X			
T521	High Voltage		X		X	X		
T523	Facedown Terminal	X	X**	X	X**			X
T525	High Temperature	X	*			X		
T527	Small Size	X			X		X	
T529	Miniature	X	X		X		X	
T530	High Cap/ Low ESR	X	X		X	X		

* Not recommended for new design.

** Selected values.

Ordering Information

T	520	V	157	M	006	A	T	E045	
Capacitor Class	Series	Case Size ¹	Capacitance Code (pF)	Capacitance Tolerance	Rated Voltage (VDC)	Failure Rate/Design	Termination Finish	ESR Code	Packaging (C-Spec)
T = Tantalum	520 = Polymer 521 = High voltage 523 = Facedown terminal 525 = 125°C rated 527 = Facedown terminal 529 = Substrate terminal 530 = 125°C High capacitance	A B C D H I J L M P Q T U V W X Y	First two digits represent significant figures. Third digit specifies number of zeros.	K = ±10% M = ±20%	002 = 2 2R5 = 2.5 003 = 3 004 = 4 006 = 6.3 008 = 8 010 = 10 011 = 11 12R = 12.5 016 = 16 020 = 20 025 = 25 035 = 35 050 = 50 063 = 63 075 = 75	A = N/A	T = 100% Matte tin (Sn) plated H*** = Tin/lead (SnPb) solder coated (5% Pb minimum) P* = Ni-Pd-Au plated N = Non-magnetic 100% Tin (Sn) M = Non-magnetic (SnPb) A** = Ni-Au	E = ESR last three digits specify ESR in mΩ (045 = 45 mΩ)	Blank = 7" reel 7280**** = 13" reel

Gold termination available upon request

* P termination only available on select part numbers

** A termination only available on T529 part numbers

*** H termination not available for T527/T529 part numbers

**** 13" reel not available for T520A case part numbers

Performance Characteristics

Item	Performance Characteristics
Operating Temperature	-55°C to 85°C/105°C/125°C (refer to part number for maximum temperature rating)
Rated Capacitance Range	4.7 – 1,500 µF at 120 Hz/25°C
Capacitance Tolerance	K tolerance (10%), M tolerance (20%)
Rated Voltage Range	2 – 75 V
DF (120 Hz)	Refer to Part Number Electrical Specification Table*
ESR (100 kHz)	Refer to Part Number Electrical Specification Table
Leakage Current	Refer to Part Number Electrical Specification Table

* For T529 Series DF measurement apply 1.5 V DC

Qualification

Test	Condition	Characteristics				
Endurance	Temperature: 85°C, 105°C, 125°C ** Voltage: 1.0 Rated Voltage 2/3 Rated Voltage for 125°C rating PN Time: 2,000 Hours 1,000 Hours for T527/T529 Series	Δ C/C	Within -20%/+10% of initial value T527 and T529 Series: Within initial DC/C limits			
		DF	Within initial limits T527 and T529: Within 1.5 x initial limits			
		DCL	85°C and 105°C rated parts: Within 1.25 x initial limit 125°C rated parts: Within 2.0 x initial limits T527 Series: Within initial limits T529 Series: Within 3.0 x initial limits			
		ESR	Within 2.0 x initial limit (N/A for T527 & T529)			
Storage Life	Temperature: 105°C, 125°C ** Voltage: 0 Voltage Time: 2,000 Hours (N/A for T527 and T529 Series)	Δ C/C	Within -20%/+10% of initial value			
		DF	Within initial limits			
		DCL	Within 1.25 x initial limit T521 Series: 1.25 x IL at 105°C, 2x IL at 125°C T525/T530 Series: Within 2.0 x initial limit			
		ESR	Within 2.0 x initial limit			
Humidity	Temperature: 60°C Voltage: No Load Humidity: 90% RH Time: 500 Hours, 1,000 Hours (T525, T530)	Δ C/C	Within -5%/+35% of initial value T527/T529 Series: -20%/+30% of initial DC/C limit			
		DF	Within initial limits T527/T529 Series: Within 1.5 x initial limits			
		DCL	Within 5.0 x initial limit T521/T525/T529/T530 Series: Within 3.0 x initial limit T527 Series: Within initial limits			
		ESR	Within 2.0 x initial limit T525/T527/T529/T530: N/A			
Temperature Stability	Extreme temperature exposure at a succession of continuous steps at +25°C, -55°C, +25°C, +85°C, +105°/125°C, +25°C	+25°C	-55°C	+85°C	+105°/125°C	
		Δ C/C	IL*	+/-20% -20% to 0% of DC/C (T527/29)	±20%	+/-30% +50% -0% of DC/C (T527/29)
		DF	IL	IL	1.2 x IL	1.5 x IL IL (T529)
Surge Voltage	Temperature: 105°C, 85°C (T527/T529) Voltage: 1.32 x Rated voltage Time: 1,000 cycles	Δ C/C	Within -20%/+10% of initial value T527/T529 Series: Within initial DC/C limits			
		DF	Within initial limits			
		DCL	Within initial limits			
Mechanical Shock/Vibration	MIL-STD-202, Method 213, Condition I, 100 G Peak. MIL-STD-202, Method 204, Condition D, 10 Hz to 2,000 Hz, 20 G peak	ESR	Within initial limits T527/T529 Series: N/A			
		Δ C/C	Within ±10% of initial value Within initial DC/C limits			
		DF	Within initial limits			
		DCL	Within initial limits			

*IL = Initial limit

**Refer to part number specifications for individual temperature classification.

Reliability

KO-CAP capacitors have an average failure rate of 0.5 %/1,000 hours at category voltage, U_C , and category temperature, T_C . These capacitors are qualified using industry test standards at U_C and T_C . The minimum test time (1,000 hours or 2,000 hours) is dependent on the product series.

The actual life expectancy of KO-CAP capacitors increases when application voltage, U_A , and application temperature, T_A , are lower than U_C and T_C . As a general guideline, when $U_A < 0.9 * U_C$ and $T_A < 85^\circ\text{C}$, the life expectancy will typically exceed the useful lifetime of most hardware (> 10 years).

The lifetime of a KO-CAP capacitor at a specific application voltage and temperature can be modeled using the equations below. A failure is defined as passing enough current to blow a 1-amp fuse. The calculation is an estimation based on empirical results and is not a guarantee.

$$VAF = \left(\frac{U_C}{U_A}\right)^n$$

where:
 VAF = acceleration factor due to voltage, unitless
 U_C = category voltage, volt
 U_A = application voltage, volt
 n = exponent, 16

$$TAF = e^{\left[\frac{E_a}{k} \left(\frac{1}{273+T_A} - \frac{1}{273+T_C}\right)\right]}$$

where:
 TAF = acceleration factor due to temperature, unitless
 E_a = activation energy, 1.4 eV
 k = Boltzmann's constant, 8.617E-5 eV/K
 T_A = application temperature, °C
 T_C = category temperature, °C

$$AF = VAF * TAF$$

where:
 AF = acceleration factor, unitless
 TAF = acceleration factor due to temperature, unitless
 VAF = acceleration factor due to voltage, unitless

$$Life_{U_A, T_A} = Life_{U_C, T_C} * AF$$

where:
 $Life_{U_A, T_A}$ = guaranteed life application voltage and temperature, years
 $Life_{U_C, T_C}$ = guaranteed life category voltage and temperature, years
 AF = acceleration factor, unitless

Terms:

Category voltage, U_C : maximum recommended peak DC operating voltage for continuous operation at the category temperature, T_C
 Rated voltage, U_R : maximum recommended peak DC operating voltage for continuous operation up to the rated temperature, T_R
 Category temperature, T_C : maximum recommended operating temperature. Voltage derating may be required at T_C
 Rated temperature, T_R : maximum recommended operating temperature without voltage derating. T_R is equal to or lower than T_C

Reliability Table 1 – Common temperature range classifications														
85°C (T_R) / 85°C (T_C)	Rated Voltage (U_R)	2.5	4.0	6.3	8.0	10.0	12.5	16.0	20.0	25.0	35.0	50.0	63.0	75.0
	Category Voltage (U_C)	2.5	4.0	6.3	8.0	10.0	12.5	16.0	20.0	25.0	35.0	50.0	63.0	75.0
105°C (T_R) / 105°C (T_C)	Rated Voltage (T_R)	2.5	4.0	6.3	8.0	10.0	12.5	16.0	20.0	25.0	35.0	50.0	63.0	75.0
	Category Voltage (U_C)	2.5	4.0	6.3	8.0	10.0	12.5	16.0	20.0	25.0	35.0	50.0	63.0	75.0
105°C (T_R) / 125°C (T_C)	Rated Voltage (T_R)	2.5	4.0	6.3	8.0	10.0	12.5	16.0	20.0	25.0	35.0	50.0	63.0	75.0
	Category Voltage (U_C)	1.7	2.7	4.2	5.4	6.7	8.4	10.7	13.4	16.8	23.5	33.5	42.2	50.3

Electrical Characteristics

T520 Standard (2 V – 10 V)

ESR vs. Frequency

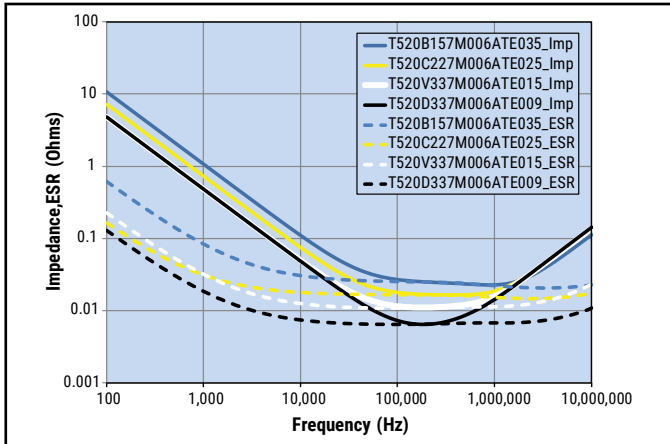

Capacitance vs. Frequency

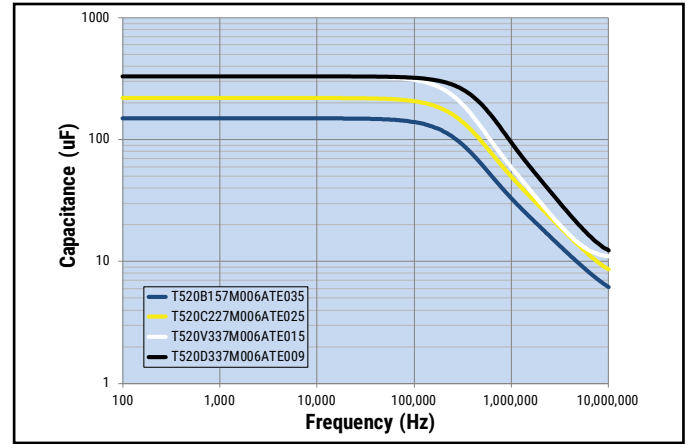

T521 High Voltage (12 V – 75 V)

ESR vs. Frequency

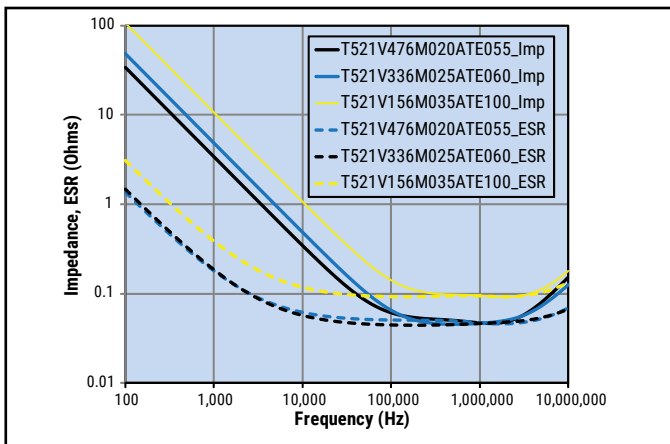

Capacitance vs. Frequency

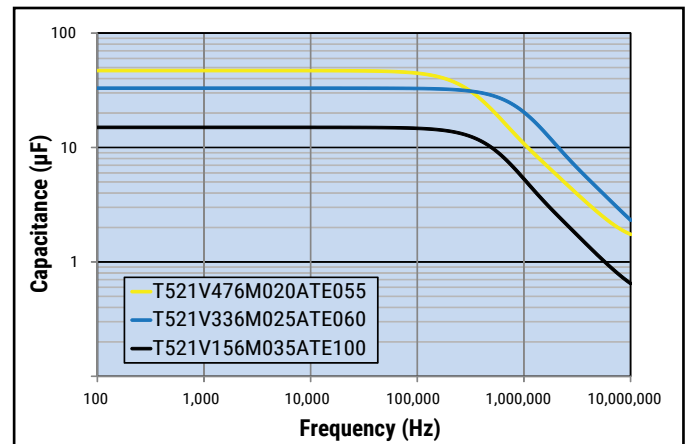

T530 High Cap/Low ESR (2 V – 10 V)

ESR vs. Frequency

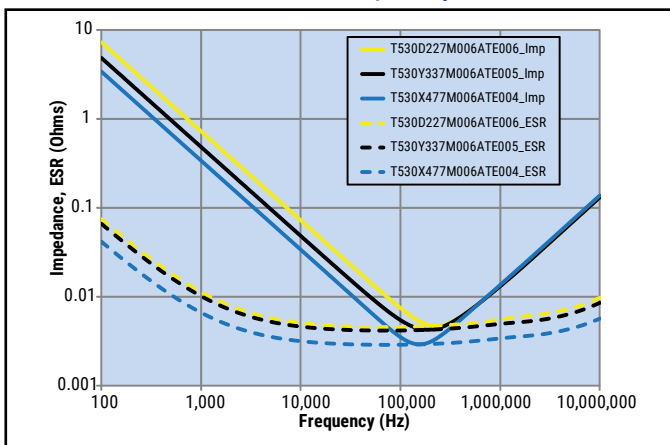

Capacitance vs. Frequency

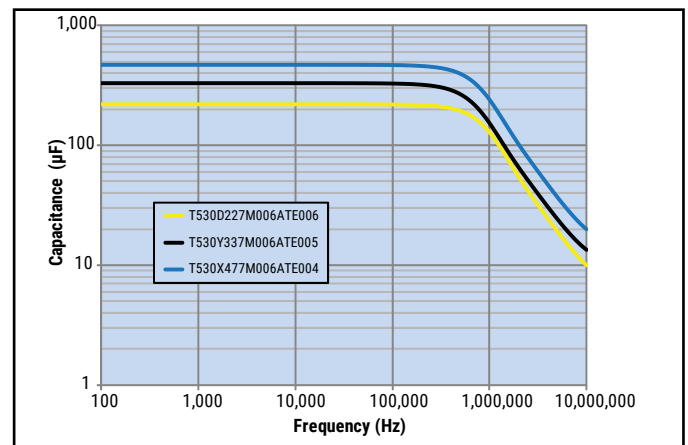

Dimensions – Millimeters (Inches)

Metric will govern

T520/T521/T525/T530

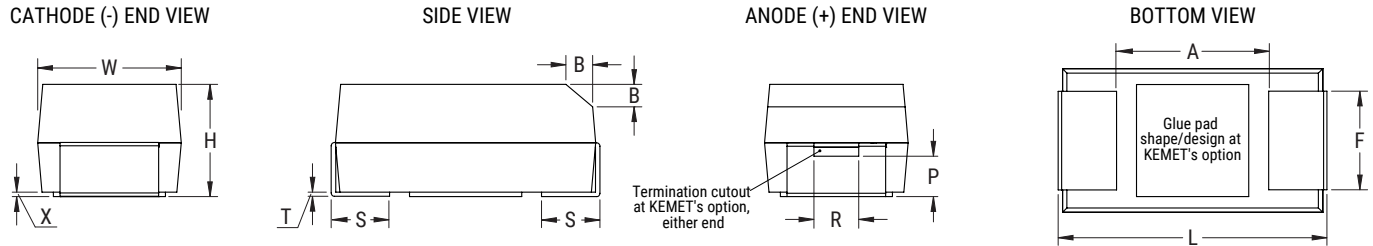

Case Size		Component Dimensions											Total Weight (mg)
KEMET	EIA	L	W	H	F	S	B±0.15	X	P	R	T	A	
					±0.1 ±(0.004)	±0.3 ±(0.012) S1 ±0.4 (0.0157) S2 ±0.2 (0.00)	(Ref) ±0.006	(Ref)	(Ref)	(Ref)	(Ref)	(Min)	
A	3216-18	3.2±0.2 (0.126±0.008)	1.6±0.2 (0.063±0.008)	1.6±0.2 (0.063±0.008)	1.2 (0.047)	0.80 (0.032)	N/A	0.10±0.10 (0.004±0.004)	0.4 (0.016)	0.4 (0.016)	0.13 (0.005)	1.2 (0.047)	53
B	3528-21	3.5±0.2 (0.138±0.008)	2.8±0.2 (0.110±0.008)	1.9±0.2 (0.075±0.008)	2.2 (0.087)	0.80 (0.032)	0.4 (0.016)	0.10±0.10 (0.004±0.004)	0.5 (0.020)	1.0 (0.039)	0.13 (0.005)	1.9 (0.075)	95
C	6032-28	6.0±0.3 (0.236±0.012)	3.2±0.3 (0.126±0.012)	2.5±0.3 (0.098±0.012)	2.2 (0.087)	1.30 (0.051)	0.5 (0.020)	0.10±0.10 (0.004±0.004)	0.9 (0.035)	1.0 (0.039)	0.13 (0.005)	2.9 (0.114)	184
D	7343-31	7.3±0.3 (0.287±0.012)	4.3±0.3 (0.169±0.012)	2.8±0.3 (0.110±0.012)	2.4 (0.094)	1.30 (0.051)	0.5 (0.020)	0.10±0.10 (0.004±0.004)	0.9 (0.035)	1.0 (0.039)	0.13 (0.005)	3.6 (0.142)	435
H	7360-20	7.3±0.3 (0.287±0.012)	6.0±0.3 (0.236±0.012)	1.9±0.1 (0.075±0.004)	4.1 (0.161)	1.3 (0.051)	N/A	0.10±0.10 (0.004±0.004)	N/A	N/A	0.13 (0.005)	3.3 (0.130)	385
J	7360-15	7.3±0.3 (0.287±0.012)	6.0±0.3 (0.236±0.012)	1.5 (0.059) Maximum	4.1 (0.161)	1.3 (0.051)	N/A	0.10±0.10 (0.004±0.004)	N/A	N/A	N/A	3.3 (0.130)	263
L	6032-19	6.0±0.3 (0.236±0.012)	3.2±0.2 (0.110±0.008)	1.8±0.1 (0.071±0.004)	2.2 (0.087)	1.3 (0.051)	N/A	0.05 (0.002)	N/A	N/A	0.13 (0.005)	2.5 (0.098)	187
M	3528-15	3.5±0.2 (0.138±0.008)	2.8±0.2 (0.110±0.008)	1.4±0.1 (0.055±0.004)	2.2 (0.087)	0.8 (0.031)	N/A	0.05 (0.002)	N/A	N/A	0.13 (0.005)	1.1 (0.043)	98
Q	7343-12	7.3±0.3 (0.287±0.012)	4.3±0.3 (0.169±0.012)	1.1±0.1 (0.043±0.004)	2.4 (0.094)	1.3 (0.051)	N/A	0.05 (0.002)	N/A	N/A	0.13 (0.005)	3.8 (0.150)	170
T	3528-12	3.5±0.2 (0.138±0.008)	2.8±0.2 (0.110±0.008)	1.1±0.1 (0.043±0.004)	2.2 (0.087)	0.80 (0.032)	N/A	0.05 (0.002)	N/A	N/A	0.13 (0.005)	1.9 (0.075)	55
U	6032-15	6.0±0.3 (0.236±0.012)	3.2±0.3 (0.126±0.012)	1.4±0.1 (0.055±0.004)	2.2 (0.087)	1.30 (0.051)	N/A	0.05 (0.002)	N/A	N/A	0.13 (0.005)	2.9 (0.114)	117
V	7343-19	7.3±0.3 (0.287±0.012)	4.3±0.3 (0.169±0.012)	1.8±0.1 * (0.071±0.004)	2.4 (0.094)	1.30 (0.051)	N/A	0.05 (0.002)	N/A	N/A	0.13 (0.005)	3.6 (0.142)	274
W	7343-15	7.3±0.3 (0.287±0.012)	4.3±0.3 (0.169±0.012)	1.4±0.1 (0.055±0.004)	2.4(.094) 2.8±0.2 (0.110±0.0079)**	1.30 (0.051) S1 = 5.0 (0.197) ** S2 = 1.3 (0.051) **	N/A	0.05 (0.002)	N/A	N/A	0.13 (0.005)	3.6 (0.142)	223
X	7343-43	7.3±0.3 (0.287±0.012)	4.3±0.3 (0.169±0.012)	4.0±0.3 (0.157±0.012)	2.4 (0.094)	1.30 (0.051)	0.5 (0.020)	0.10±0.10 (0.004±0.004)	1.7 (0.067)	1.0 (.039)	0.13 (0.005)	3.6 (0.142)	554
Y	7343-40	7.3±0.3 (0.287±0.012)	4.3±0.3 (0.169±0.012)	3.8±0.2 (0.150±0.008)	2.4 (0.094)	1.3 (0.051)	0.5 (0.020)	0.10±0.10 (0.004±0.004)	1.7 (0.067)	1.0 (0.039)	0.13 (0.005)	3.8 (0.150)	494

* Height tolerance is ±0.2 for V case T521 only

** S1 and S2 is for T528 series only

Dimensions – Millimeters cont'd

T523



KEMET	EIA	L	W	H	F ±0.1 (±0.004)	S ±0.3 (±0.012)	Total Weight (mg)
W	7343-15	7.3±0.3 (0.287±0.012)	4.3±0.3 (0.169±0.012)	1.4±0.1 (0.055±0.004)	2.4 (0.094)	1.3 (0.051)	223
J	7360-15	7.3±0.3 (0.287±0.012)	6.0±0.3 (0.236±0.012)	1.4±0.1 (0.055±0.004)	4.45 (0.175)	1.6 (0.063)	263
V	7343-20	7.3±0.3 (0.287±0.012)	4.3±0.3 (0.169±0.012)	1.9±0.1 (0.075±0.004)	2.4 (0.094)	1.3 (0.051)	274
H	7360-20	7.3±0.3 (0.287±0.012)	6.0±0.3 (0.236±0.012)	1.9±0.1 (0.075±0.004)	4.45 (0.175)	1.6 (0.063)	385

T527



Case Size		Component Dimensions					Weight
KEMET	EIA	L	W	H	F	S	(mg)
I	3216-10	3.2±0.2	1.6±0.2	0.9±0.1	1.2±0.1	0.8±0.2	70

T529



Case Size		Component Dimensions					Weight
KEMET	EIA	L	W	H	F	S	(mg)
P	2012-10	2.0±0.1	1.25±0.1	1.0 maximum	0.9±0.1	0.55±0.1	11.4
I	3216-10	3.2±0.2	1.6±0.2	1.0 maximum	1.2±0.1	0.8±0.1	70

Table 1 – Ratings & Part Number Reference

Rated Voltage	Rated Capacitance	Case Code/ Case Size	KEMET Part Number	DC Leakage	DF	ESR	Maximum Allowable Ripple Current	MSL	Maximum Operating Temp
VDC at 105°C	µF	KEMET/EIA	(See below for part options)	µA at 25°C Maximum/ 5 Minutes	% at 25°C 120 Hz Maximum	mΩ at 25°C 100 kHz Maximum	mA at +45°C 100 kHz	Reflow Temp ≤ 260°C	°C
2	470	V/7343-19	T520V477M002A(1)E040	94	10	40	2200	3	105
2.5	47	A/3216-18	T520A476M2R5A(1)E090	11.75	8	90	1100	3	105
2.5	68	A/3216-18	T520A686M2R5A(1)E070	17	8	70	1300	3	105
2.5	68	A/3216-18	T520A686M2R5A(1)E080	17	8	80	1200	3	105
2.5	100	T/3528-12	T520T107M2R5A(1)E040	25	8	40	1600	3	105
2.5	100	T/3528-12	T520T107M2R5A(1)E070	25	8	70	1200	3	105
2.5	100	T/3528-12	T525T107M2R5A(1)E080	25	10	80	1100	3	125
2.5	100	B/3528-21	T520B107M2R5A(1)E025	25	8	25	2300	3	105
2.5	100	B/3528-21	T520B107M2R5A(1)E035	25	8	35	1900	3	105
2.5	100	B/3528-21	T520B107M2R5A(1)E040	25	8	40	1800	3	105
2.5	100	B/3528-21	T520B107M2R5A(1)E070	25	8	70	1300	3	105
2.5	150	U/6032-15	T520U157M2R5A(1)E055	37.5	8	55	1600	3	105
2.5	220	A/3216-18	T520A227M2R5A(1)E025	55	8	25	1732	3	105
2.5	220	A/3216-18	T520A227M2R5A(1)E035	55	8	35	1500	3	105
2.5	220	B/3528-21	T520B227M2R5A(1)E015	55	8	15	2900	3	105
2.5	220	B/3528-21	T520B227M2R5A(1)E018	55	8	18	2700	3	105
2.5	220	B/3528-21	T520B227M2R5A(1)E021	55	8	21	2500	3	105
2.5	220	B/3528-21	T520B227M2R5A(1)E025	55	8	25	2300	3	105
2.5	220	B/3528-21	T520B227M2R5A(1)E030	55	8	30	2100	3	105
2.5	220	B/3528-21	T520B227M2R5A(1)E035	55	8	35	1900	3	105
2.5	220	B/3528-21	T520B227M2R5A(1)E055	55	8	55	1500	3	105
2.5	220	B/3528-21	T520B227M2R5A(1)E070	55	8	70	1300	3	105
2.5	220	T/3528-12	T520T227M2R5A(1)E070	55	10	70	1200	3	105
2.5	220	U/6032-15	T520U227M2R5A(1)E055	55	8	55	1600	3	105
2.5	220	C/6032-28	T520C227M2R5A(1)E025	55	8	25	2600	3	105
2.5	220	C/6032-28	T520C227M2R5A(1)E045	55	8	45	1900	3	105
2.5	220	W/7343-15	T520W227M2R5A(1)E025	55	10	25	2700	3	105
2.5	220	V/7343-19	T520V227M2R5A(1)E006	55	10	6	5600	3	105
2.5	220	V/7343-19	T520V227M2R5A(1)E007	55	10	7	5200	3	105
2.5	220	V/7343-19	T520V227M2R5A(1)E009	55	10	9	4600	3	105
2.5	220	V/7343-19	T520V227M2R5A(1)E012	55	10	12	3900	3	105
2.5	220	V/7343-19	T520V227M2R5A(1)E015	55	10	15	3500	3	105
2.5	220	V/7343-19	T520V227M2R5A(1)E025	55	10	25	2700	3	105
2.5	220	V/7343-19	T520V227M2R5A(1)E045	55	10	45	2000	3	105
2.5	220	D/7343-31	T520D227M2R5A(1)E007	55	10	7	5700	3	105
2.5	220	D/7343-31	T520D227M2R5A(1)E040	55	10	40	2400	3	105
2.5	330	B/3528-21	T520B337M2R5A(1)E009	82.5	8	9	3073	3	105
2.5	330	B/3528-21	T520B337M2R5A(1)E012	83	8	12	2700	3	105
2.5	330	B/3528-21	T520B337M2R5A(1)E015	82.5	8	15	2900	3	105
2.5	330	B/3528-21	T520B337M2R5A(1)E018	82.5	8	18	2700	3	105
2.5	330	B/3528-21	T520B337M2R5A(1)E035	82.5	8	35	1900	3	105
2.5	330	B/3528-21	T520B337M2R5A(1)E045	82.5	8	45	1700	3	105
2.5	330	B/3528-21	T520B337M2R5A(1)E070	82.5	8	70	1300	3	105
VDC at 105°C	µF	KEMET/EIA	(See below for part options)	µA at 25°C Maximum/ 5 Minutes	% at 25°C 120 Hz Maximum	mΩ at 25°C 100 kHz Maximum	mA at +45°C 100 kHz	Reflow Temp ≤ 260°C	°C
Rated Voltage	Rated Capacitance	Case Code/ Case Size	KEMET Part Number	DC Leakage	DF	ESR	Maximum Allowable Ripple Current	MSL	Maximum Operating Temp

(1) To complete KEMET part number, insert T = 100% Matte Tin (Sn) Plated, H = Standard Solder coated (SnPb 5% Pb minimum), N = Non-Magnetic 100% Tin (Sn), M = Non-Magnetic (SnPb). Refer to Ordering Information for additional detail.

(2) To complete KEMET part number, insert M for ± 20% or K for ± 10%. Designates Capacitance tolerance.

Higher voltage ratings and tighter ESR may be substituted within the same size at KEMET's option. Voltage substitutions will be marked with the higher voltage rating. Substitutions can include better than series.

Part numbers marked in blue font are not recommended for new designs. Please use the T521 series instead.

Part numbers marked in orange font are not recommended for new designs. Please contact your KEMET representative for a replacement part.

^ Denotes the large reel (13") is not available.

Refer to Ordering Information for additional detail.

Table 1 – Ratings & Part Number Reference cont'd

Rated Voltage	Rated Capacitance	Case Code/ Case Size	KEMET Part Number	DC Leakage	DF	ESR	Maximum Allowable Ripple Current	MSL	Maximum Operating Temp
VDC at 105°C	µF	KEMET/EIA	(See below for part options)	µA at 25°C Maximum/ 5 Minutes	% at 25°C 120 Hz Maximum	mΩ at 25°C 100 kHz Maximum	mA at +45°C 100 kHz	Reflow Temp ≤ 260°C	°C
2.5	330	C/6032-28	T520C337M2R5A(1)E015	82.5	8	15	3300	3	105
2.5	330	C/6032-28	T520C337M2R5A(1)E018	82.5	8	18	3000	3	105
2.5	330	C/6032-28	T520C337M2R5A(1)E025	82.5	8	25	2600	3	105
2.5	330	C/6032-28	T520C337M2R5A(1)E045	82.5	8	45	1900	3	105
2.5	330	L/6032-19	T520L337M2R5A(1)E009	82.5	8	9	4100	3	105
2.5	330	L/6032-19	T520L337M2R5A(1)E012	82.5	8	12	3500	3	105
2.5	330	L/6032-19	T520L337M2R5A(1)E025	82.5	8	25	2400	3	105
2.5	330	W/7343-15	T520W337M2R5A(1)E015	82.5	10	15	3500	3	105
2.5	330	W/7343-15	T520W337M2R5A(1)E025	82.5	10	25	2700	3	105
2.5	330	W/7343-15	T520W337M2R5A(1)E040	82.5	10	40	2100	3	105
2.5	330	V/7343-19	T520V337M2R5A(1)E006	82.5	10	6	5600	3	105
2.5	330	V/7343-19	T520V337M2R5A(1)E007	82.5	10	7	5200	3	105
2.5	330	V/7343-19	T520V337M2R5A(1)E009	82.5	10	9	4600	3	105
2.5	330	V/7343-19	T520V337M2R5A(1)E012	82.5	10	12	3900	3	105
2.5	330	V/7343-19	T520V337M2R5A(1)E015	82.5	10	15	3500	3	105
2.5	330	V/7343-19	T520V337M2R5A(1)E018	82.5	10	18	3200	3	105
2.5	330	V/7343-19	T520V337M2R5A(1)E025	82.5	10	25	2700	3	105
2.5	330	V/7343-19	T520V337M2R5A(1)E040	82.5	10	40	2200	3	105
2.5	330	D/7343-31	T520D337M2R5A(1)E006	82.5	10	6	6100	3	105
2.5	330	D/7343-31	T520D337M2R5A(1)E007	82.5	10	7	5700	3	105
2.5	330	D/7343-31	T525D337M2R5A(1)E025	82.5	10	25	3000	3	125
2.5	470	V/7343-19	T520V477M2R5A(1)E006	117.5	10	6	5600	3	105
2.5	470	V/7343-19	T520V477M2R5A(1)E007	117.5	10	7	5200	3	105
2.5	470	V/7343-19	T520V477M2R5A(1)E009	117.5	10	9	4600	3	105
2.5	470	V/7343-19	T520V477M2R5A(1)E012	117.5	10	12	3900	3	105
2.5	470	V/7343-19	T520V477M2R5A(1)E015	117.5	10	15	3500	3	105
2.5	470	V/7343-19	T520V477M2R5A(1)E018	117.5	10	18	3200	3	105
2.5	470	C/6032-28	T520C477M2R5A(1)E025	117.5	8	25	2600	3	105
2.5	470	C/6032-28	T520C477M2R5A(1)E045	117.5	8	45	1900	3	105
2.5	470	D/7343-31	T530D477M2R5A(1)E005	117.5	8	5	7100	3	125
2.5	470	D/7343-31	T520D477M2R5A(1)E006	117.5	10	6	6100	3	105
2.5	470	D/7343-31	T530D477M2R5A(1)E006	117.5	8	6	6500	3	125
2.5	470	D/7343-31	T520D477M2R5A(1)E007	117.5	10	7	5700	3	105
2.5	470	D/7343-31	T520D477M2R5A(1)E009	117.5	10	9	5000	3	105
2.5	470	D/7343-31	T530D477M2R5A(1)E010	117.5	8	10	5000	3	125
2.5	470	D/7343-31	T525D477M2R5A(1)E025	117.5	10	25	3000	3	125
2.5	560	D/7343-31	T530D567M2R5A(1)E005	140	8	5	7100	3	125
2.5	680	D/7343-31	T530D687M2R5A(1)E006	170	8	6	6500	3	125
2.5	680	D/7343-31	T530D687M2R5A(1)E007	170	8	7	6000	3	125
2.5	680	D/7343-31	T520D687M2R5A(1)E010	170	10	10	4700	3	105
2.5	680	D/7343-31	T530D687M2R5A(1)E010	170	8	10	5000	3	125
2.5	680	D/7343-31	T520D687M2R5A(1)E015	170	10	15	3900	3	105
2.5	680	D/7343-31	T525D687M2R5A(1)E025	170	10	25	3000	3	125
VDC at 105°C	µF	KEMET/EIA	(See below for part options)	µA at 25°C Maximum/ 5 Minutes	% at 25°C 120 Hz Maximum	mΩ at 25°C 100 kHz Maximum	mA at +45°C 100 kHz	Reflow Temp ≤ 260°C	°C
Rated Voltage	Rated Capacitance	Case Code/ Case Size	KEMET Part Number	DC Leakage	DF	ESR	Maximum Allowable Ripple Current	MSL	Maximum Operating Temp

(1) To complete KEMET part number, insert T = 100% Matte Tin (Sn) Plated, H = Standard Solder coated (SnPb 5% Pb minimum), N = Non-Magnetic 100% Tin (Sn), M = Non-Magnetic (SnPb). Refer to Ordering Information for additional detail.

(2) To complete KEMET part number, insert M for ± 20% or K for ± 10%. Designates Capacitance tolerance.

Higher voltage ratings and tighter ESR may be substituted within the same size at KEMET's option. Voltage substitutions will be marked with the higher voltage rating. Substitutions can include better than series.

Part numbers marked in blue font are not recommended for new designs. Please use the T521 series instead.

Part numbers marked in orange font are not recommended for new designs. Please contact your KEMET representative for a replacement part.

^ Denotes the large reel (13") is not available.

Refer to Ordering Information for additional detail.

Table 1 – Ratings & Part Number Reference cont'd

Rated Voltage	Rated Capacitance	Case Code/ Case Size	KEMET Part Number	DC Leakage	DF	ESR	Maximum Allowable Ripple Current	MSL	Maximum Operating Temp
VDC at 105°C	µF	KEMET/EIA	(See below for part options)	µA at 25°C Maximum/ 5 Minutes	% at 25°C 120 Hz Maximum	mΩ at 25°C 100 kHz Maximum	mA at +45°C 100 kHz	Reflow Temp ≤ 260°C	°C
2.5	680	D/7343-31	T520D687M2R5A(1)E040	170	10	40	2400	3	105
2.5	680	Y/7343-40	T530Y687M2R5A(1)E005	170	8	5	7300	3	125
2.5	680	Y/7343-40	T530Y687M2R5A(1)E006	170	8	6	6600	3	125
2.5	680	Y/7343-40	T530Y687M2R5A(1)E007	170	8	7	6100	3	125
2.5	680	Y/7343-40	T520Y687M2R5A(1)E015	170	10	15	4000	3	105
2.5	680	Y/7343-40	T520Y687M2R5A(1)E025	170	10	25	3100	3	105
2.5	680	X/7343-43	T530X687M2R5A(1)E006	170	8	6	6700	3	125
2.5	1000	D/7343-31	T520D108M2R5A(1)E4R5	250	10	4.5	7100	3	105
2.5	1000	D/7343-31	T520D108M2R5A(1)E006	250	10	6	6100	3	105
2.5	1000	D/7343-31	T520D108M2R5A(1)E007	250	10	7	5700	3	105
2.5	1000	D/7343-31	T520D108M2R5A(1)E009	250	10	9	5000	3	105
2.5	1000	D/7343-31	T520D108M2R5A(1)E010	250	10	10	4700	3	105
2.5	1000	D/7343-31	T520D108M2R5A(1)E015	250	10	15	3900	3	105
2.5	1000	D/7343-31	T520D108M2R5A(1)E030	250	10	30	2700	3	105
2.5	1000	Y/7343-40	T530Y108M2R5A(1)E005	250	8	5	7300	3	125
2.5	1000	Y/7343-40	T530Y108M2R5A(1)E006	250	8	6	6600	3	125
2.5	1000	Y/7343-40	T520Y108M2R5A(1)E010	250	10	10	4900	3	105
2.5	1000	Y/7343-40	T520Y108M2R5A(1)E015	250	10	15	4000	3	105
2.5	1000	Y/7343-40	T520Y108M2R5A(1)E025	250	10	25	3100	3	105
2.5	1000	X/7343-43	T530X108M2R5A(1)E004	250	8	4	8200	3	125
2.5	1000	X/7343-43	T530X108M2R5A(1)E005	250	8	5	7300	3	125
2.5	1000	X/7343-43	T530X108M2R5A(1)E006	250	8	6	6700	3	125
2.5	1000	X/7343-43	T520X108M2R5A(1)E010	250	10	10	5000	3	105
2.5	1500	X/7343-43	T530X158M2R5A(1)E005	375	8	5	7300	3	125
2.5	1500	X/7343-43	T520X158M2R5A(1)E015	375	10	15	4100	3	105
3	100	B/3528-21	T525B107M003A(1)E080	30	8	80	1300	3	125
3	100	B/3528-21	T520B107M003A(1)E025	30	8	25	2300	3	105
3	100	B/3528-21	T520B107M003A(1)E035	30	8	35	1900	3	105
3	100	B/3528-21	T520B107M003A(1)E040	30	8	40	1800	3	105
3	100	B/3528-21	T520B107M003A(1)E070	30	8	70	1300	3	105
3	150	B/3528-21	T520B157M003A(1)E025	45	8	25	2300	3	105
3	150	B/3528-21	T520B157M003A(1)E035	45	8	35	1900	3	105
3	150	B/3528-21	T520B157M003A(1)E040	45	8	40	1800	3	105
3	150	B/3528-21	T520B157M003A(1)E070	45	8	70	1300	3	105
3	150	B/3528-21	T525B157M003A(1)E080	45	8	80	1300	3	125
3	330	V/7343-19	T520V337M003A(1)E009	99	10	9	4600	3	105
3	330	V/7343-19	T520V337M003A(1)E012	99	10	12	3900	3	105
3	330	V/7343-19	T520V337M003A(1)E015	99	10	15	3500	3	105
3	330	V/7343-19	T520V337M003A(1)E025	99	10	25	2700	3	105
3	330	D/7343-31	T525D337M003A(1)E025	99	10	25	3000	3	125
3	470	D/7343-31	T530D477M003A(1)E010	141	8	10	5000	3	125
3	470	D/7343-31	T525D477M003A(1)E025	141	10	25	3000	3	125
3	680	D/7343-31	T530D687M003A(1)E010	204	8	10	5000	3	125
VDC at 105°C	µF	KEMET/EIA	(See below for part options)	µA at 25°C Maximum/ 5 Minutes	% at 25°C 120 Hz Maximum	mΩ at 25°C 100 kHz Maximum	mA at +45°C 100 kHz	Reflow Temp ≤ 260°C	°C
Rated Voltage	Rated Capacitance	Case Code/ Case Size	KEMET Part Number	DC Leakage	DF	ESR	Maximum Allowable Ripple Current	MSL	Maximum Operating Temp

(1) To complete KEMET part number, insert T = 100% Matte Tin (Sn) Plated, H = Standard Solder coated (SnPb 5% Pb minimum), N = Non-Magnetic 100% Tin (Sn), M = Non-Magnetic (SnPb). Refer to Ordering Information for additional detail.

(2) To complete KEMET part number, insert M for ± 20% or K for ± 10%. Designates Capacitance tolerance.

Higher voltage ratings and tighter ESR may be substituted within the same size at KEMET's option. Voltage substitutions will be marked with the higher voltage rating. Substitutions can include better than series.

Part numbers marked in blue font are not recommended for new designs. Please use the T521 series instead.

Part numbers marked in orange font are not recommended for new designs. Please contact your KEMET representative for a replacement part.

^ Denotes the large reel (13") is not available.

Refer to Ordering Information for additional detail.

Table 1 – Ratings & Part Number Reference cont'd

Rated Voltage	Rated Capacitance	Case Code/ Case Size	KEMET Part Number	DC Leakage	DF	ESR	Maximum Allowable Ripple Current	MSL	Maximum Operating Temp
VDC at 105°C	µF	KEMET/EIA	(See below for part options)	µA at 25°C Maximum/ 5 Minutes	% at 25°C 120 Hz Maximum	mΩ at 25°C 100 kHz Maximum	mA at +45°C 100 kHz	Reflow Temp ≤ 260°C	°C
3	680	D/7343-31	T520D687M003A(1)E015	204	10	15	3900	3	105
3	680	D/7343-31	T525D687M003A(1)E025	204	10	25	3000	3	125
3	680	D/7343-31	T520D687M003A(1)E040	204	10	40	2400	3	105
3	1000	X/7343-43	T530X108M003A(1)E010	300	8	10	5200	3	125
3	1000	X/7343-43	T520X108M003A(1)E015	300	10	15	4100	3	105
3	1000	X/7343-43	T520X108M003A(1)E030	300	10	30	2900	3	105
3	1500	X/7343-43	T530X158M003A(1)E008	450	8	8	5800	3	125
4	15	T/3528-12	T520T156M004A(1)E100	6	8	100	1000	3	105
4	33	A/3216-18	T520A336M004A(1)E070	13.2	8	70	1300	3	105
4	33	A/3216-18	T520A336M004A(1)E080	13.2	8	80	1200	3	105
4	47	A/3216-18	T520A476M004A(1)E070	18.8	8	70	1300	3	105
4	47	A/3216-18	T520A476M004A(1)E080	18.8	8	80	1200	3	105
4	47	T/3528-12	T520T476M004A(1)E070	18.8	8	70	1200	3	105
4	68	A/3216-18	T520A686M004A(1)E180	27	8	180	800	3	105
4	68	T/3528-12	T520T686M004A(1)E070	27.2	8	70	1200	3	105
4	68	B/3528-21	T520B686M004A(1)E025	27.2	8	25	2300	3	105
4	68	B/3528-21	T520B686M004A(1)E035	27.2	8	35	1900	3	105
4	68	B/3528-21	T520B686M004A(1)E040	27.2	8	40	1800	3	105
4	68	B/3528-21	T520B686M004A(1)E070	27.2	8	70	1300	3	105
4	68	B/3528-21	T525B686M004A(1)E080	27.2	8	80	1300	3	125
4	68	U/6032-15	T520U686M004A(1)E055	27.2	8	55	1600	3	105
4	100	I/3216-10	T527I107M004ATE200	40	8	200	775	3	105
4	100	A/3216-18	T520A107M004A(1)E150	40	8	150	900	3	105
4	100	A/3216-18	T520A107M004A(1)E200	40	8	200	700	3	105
4	100	T/3528-12	T520T107M004A(1)E070	40	8	70	1200	3	105
4	100	T/3528-12	T520T107M004A(1)E150	40	8	150	800	3	105
4	100	B/3528-21	T520B107M004A(1)E025	40	8	25	2300	3	105
4	100	B/3528-21	T520B107M004A(1)E035	40	8	35	1900	3	105
4	100	B/3528-21	T520B107M004A(1)E040	40	8	40	1800	3	105
4	100	B/3528-21	T520B107M004A(1)E070	40	8	70	1300	3	105
4	100	B/3528-21	T525B107M004A(1)E080	40	8	80	1300	3	125
4	100	U/6032-15	T520U107M004A(1)E055	40	8	55	1600	3	105
4	150	B/3528-21	T520B157M004A(1)E015	60	8	15	2900	3	105
4	150	B/3528-21	T520B157M004A(1)E018	60	8	18	2700	3	105
4	150	B/3528-21	T520B157M004A(1)E025	60	8	25	2300	3	105
4	150	B/3528-21	T520B157M004A(1)E030	60	8	30	2100	3	105
4	150	B/3528-21	T520B157M004A(1)E035	60	8	35	1900	3	105
4	150	B/3528-21	T520B157M004A(1)E040	60	8	40	1800	3	105
4	150	B/3528-21	T520B157M004A(1)E070	60	8	70	1300	3	105
4	150	U/6032-15	T520U157M004A(1)E055	60	8	55	1600	3	105
4	150	C/6032-28	T520C157M004A(1)E015	60	8	15	3300	3	105
4	150	C/6032-28	T520C157M004A(1)E025	60	8	25	2600	3	105
4	150	C/6032-28	T520C157M004A(1)E045	60	8	45	1900	3	105
VDC at 105°C	µF	KEMET/EIA	(See below for part options)	µA at 25°C Maximum/ 5 Minutes	% at 25°C 120 Hz Maximum	mΩ at 25°C 100 kHz Maximum	mA at +45°C 100 kHz	Reflow Temp ≤ 260°C	°C
Rated Voltage	Rated Capacitance	Case Code/ Case Size	KEMET Part Number	DC Leakage	DF	ESR	Maximum Allowable Ripple Current	MSL	Maximum Operating Temp

(1) To complete KEMET part number, insert T = 100% Matte Tin (Sn) Plated, H = Standard Solder coated (SnPb 5% Pb minimum), N = Non-Magnetic 100% Tin (Sn), M = Non-Magnetic (SnPb). Refer to Ordering Information for additional detail.

(2) To complete KEMET part number, insert M for ± 20% or K for ± 10%. Designates Capacitance tolerance.

Higher voltage ratings and tighter ESR may be substituted within the same size at KEMET's option. Voltage substitutions will be marked with the higher voltage rating. Substitutions can include better than series.

Part numbers marked in blue font are not recommended for new designs. Please use the T521 series instead.

Part numbers marked in orange font are not recommended for new designs. Please contact your KEMET representative for a replacement part.

^ Denotes the large reel (13") is not available.

Refer to Ordering Information for additional detail.

Table 1 – Ratings & Part Number Reference cont'd

Rated Voltage	Rated Capacitance	Case Code/ Case Size	KEMET Part Number	DC Leakage	DF	ESR	Maximum Allowable Ripple Current	MSL	Maximum Operating Temp
VDC at 105°C	µF	KEMET/EIA	(See below for part options)	µA at 25°C Maximum/ 5 Minutes	% at 25°C 120 Hz Maximum	mΩ at 25°C 100 kHz Maximum	mA at +45°C 100 kHz	Reflow Temp ≤ 260°C	°C
4	150	C/6032-28	T520C157M004A(1)E100	60	8	100	1300	3	105
4	150	V/7343-19	T520V157M004A(1)E007	60	10	7	5200	3	105
4	150	V/7343-19	T520V157M004A(1)E009	60	10	9	4600	3	105
4	150	V/7343-19	T520V157M004A(1)E012	60	10	12	3900	3	105
4	150	V/7343-19	T520V157M004A(1)E015	60	10	15	3500	3	105
4	150	V/7343-19	T520V157M004A(1)E025	60	10	25	2700	3	105
4	150	D/7343-31	T520D157M004A(1)E007	60	10	7	5700	3	105
4	220	B/3528-21	T520B227M004A(1)E035	88	8	35	1900	3	105
4	220	B/3528-21	T520B227M004A(1)E045	88	8	45	1700	3	105
4	220	B/3528-21	T520B227M004A(1)E070	88	8	70	1300	3	105
4	220	C/6032-28	T520C227M004A(1)E015	88	8	15	3300	3	105
4	220	C/6032-28	T520C227M004A(1)E018	88	8	18	3000	3	105
4	220	C/6032-28	T520C227M004A(1)E025	88	8	25	2600	3	105
4	220	C/6032-28	T520C227M004A(1)E045	88	8	45	1900	3	105
4	220	C/6032-28	T520C227M004A(1)E055	88	8	55	1700	3	105
4	220	L/6032-19	T520L227M004A(1)E012	88	8	12	3500	3	105
4	220	L/6032-19	T520L227M004A(1)E025	88	8	25	2400	3	105
4	220	W/7343-15	T520W227M004A(1)E025	88	10	25	2700	3	105
4	220	W/7343-15	T520W227M004A(1)E040	88	10	40	2100	3	105
4	220	V/7343-19	T520V227M004A(1)E006	88	10	6	5600	3	105
4	220	V/7343-19	T520V227M004A(1)E007	88	10	7	5200	3	105
4	220	V/7343-19	T520V227M004A(1)E009	88	10	9	4600	3	105
4	220	V/7343-19	T520V227M004A(1)E012	88	10	12	3900	3	105
4	220	V/7343-19	T520V227M004A(1)E015	88	10	15	3500	3	105
4	220	V/7343-19	T520V227M004A(1)E018	88	10	18	3200	3	105
4	220	V/7343-19	T520V227M004A(1)E025	88	10	25	2700	3	105
4	220	V/7343-19	T520V227M004A(1)E040	88	10	40	2200	3	105
4	220	V/7343-19	T520V227M004A(1)E045	88	10	45	2000	3	105
4	220	D/7343-31	T520D227M004A(1)E006	88	10	6	6100	3	105
4	220	D/7343-31	T520D227M004A(1)E007	88	10	7	5700	3	105
4	220	D/7343-31	T520D227M004A(1)E012	88	10	12	4300	3	105
4	220	D/7343-31	T525D227M004A(1)E025	88	10	25	3000	3	125
4	220	D/7343-31	T520D227M004A(1)E065	88	10	65	1900	3	105
4	330	C/6032-28	T520C337M004A(1)E025	132	8	25	2600	3	105
4	330	C/6032-28	T520C337M004A(1)E045	132	8	45	1900	3	105
4	330	V/7343-19	T520V337M004A(1)E007	132	10	7	5200	3	105
4	330	V/7343-19	T520V337M004A(1)E009	132	10	9	4600	3	105
4	330	V/7343-19	T520V337M004A(1)E012	132	10	12	3900	3	105
4	330	V/7343-19	T520V337M004A(1)E018	132	10	18	3200	3	105
4	330	V/7343-19	T520V337M004A(1)E025	132	10	25	2700	3	105
4	330	V/7343-19	T520V337M004A(1)E040	132	10	40	2200	3	105
4	330	D/7343-31	T530D337M004A(1)E005	132	8	5	7100	3	125
4	330	D/7343-31	T520D337M004A(1)E006	132	10	6	6100	3	105
VDC at 105°C	µF	KEMET/EIA	(See below for part options)	µA at 25°C Maximum/ 5 Minutes	% at 25°C 120 Hz Maximum	mΩ at 25°C 100 kHz Maximum	mA at +45°C 100 kHz	Reflow Temp ≤ 260°C	°C
Rated Voltage	Rated Capacitance	Case Code/ Case Size	KEMET Part Number	DC Leakage	DF	ESR	Maximum Allowable Ripple Current	MSL	Maximum Operating Temp

(1) To complete KEMET part number, insert T = 100% Matte Tin (Sn) Plated, H = Standard Solder coated (SnPb 5% Pb minimum), N = Non-Magnetic 100% Tin (Sn), M = Non-Magnetic (SnPb). Refer to Ordering Information for additional detail.

(2) To complete KEMET part number, insert M for ± 20% or K for ± 10%. Designates Capacitance tolerance.

Higher voltage ratings and tighter ESR may be substituted within the same size at KEMET's option. Voltage substitutions will be marked with the higher voltage rating. Substitutions can include better than series.

Part numbers marked in blue font are not recommended for new designs. Please use the T521 series instead.

Part numbers marked in orange font are not recommended for new designs. Please contact your KEMET representative for a replacement part.

^ Denotes the large reel (13") is not available.

Refer to Ordering Information for additional detail.

Table 1 – Ratings & Part Number Reference cont'd

Rated Voltage	Rated Capacitance	Case Code/ Case Size	KEMET Part Number	DC Leakage	DF	ESR	Maximum Allowable Ripple Current	MSL	Maximum Operating Temp
VDC at 105°C	µF	KEMET/EIA	(See below for part options)	µA at 25°C Maximum/ 5 Minutes	% at 25°C 120 Hz Maximum	mΩ at 25°C 100 kHz Maximum	mA at +45°C 100 kHz	Reflow Temp ≤ 260°C	°C
4	330	D/7343-31	T530D337M004A(1)E006	132	8	6	6500	3	125
4	330	D/7343-31	T520D337M004A(1)E007	132	10	7	5700	3	105
4	330	D/7343-31	T520D337M004A(1)E009	132	10	9	5000	3	105
4	330	D/7343-31	T520D337M004A(1)E012	132	10	12	4300	3	105
4	330	D/7343-31	T520D337M004A(1)E015	132	10	15	3900	3	105
4	330	D/7343-31	T525D337M004A(1)E025	132	10	25	3000	3	125
4	330	D/7343-31	T520D337M004A(1)E040	132	10	40	2400	3	105
4	330	D/7343-31	T520D337M004A(1)E045	132	10	45	2200	3	105
4	470	D/7343-31	T530D477M004A(1)E006	188	8	6	6500	3	125
4	470	D/7343-31	T520D477M004A(1)E010	188	10	10	4700	3	105
4	470	D/7343-31	T530D477M004A(1)E010	188	8	10	5000	3	125
4	470	D/7343-31	T520D477M004A(1)E012	188	10	12	4300	3	105
4	470	D/7343-31	T520D477M004A(1)E015	188	10	15	3900	3	105
4	470	D/7343-31	T520D477M004A(1)E018	188	10	18	3500	3	105
4	470	D/7343-31	T520D477M004A(1)E025	188	10	25	3000	3	105
4	470	D/7343-31	T525D477M004A(1)E025	188	10	25	3000	3	125
4	470	D/7343-31	T520D477M004A(1)E040	188	10	40	2400	3	105
4	470	D/7343-31	T525D477M004A(1)E040	188	10	40	2400	3	125
4	470	Y/7343-40	T530Y477M004A(1)E005	188	8	5	7300	3	125
4	470	Y/7343-40	T530Y477M004A(1)E006	188	8	6	6600	3	125
4	680	D/7343-31	T520D687M004A(1)E012	272	10	12	4300	3	105
4	680	D/7343-31	T520D687M004A(1)E015	272	10	15	3900	3	105
4	680	D/7343-31	T520D687M004A(1)E025	272	10	25	3000	3	105
4	680	Y/7343-40	T530Y687M004A(1)E005	272	8	5	7300	3	125
4	680	Y/7343-40	T520Y687M004A(1)E010	272	10	10	4900	3	105
4	680	Y/7343-40	T520Y687M004A(1)E015	272	10	15	4000	3	105
4	680	Y/7343-40	T520Y687M004A(1)E025	272	10	25	3100	3	105
4	680	X/7343-43	T530X687M004A(1)E004	272	8	4	8200	3	125
4	680	X/7343-43	T530X687M004A(1)E005	272	8	5	7300	3	125
4	680	X/7343-43	T530X687M004A(1)E006	272	8	6	6700	3	125
4	680	X/7343-43	T520X687M004A(1)E010	272	10	10	5000	3	105
4	680	X/7343-43	T530X687M004A(1)E010	272	8	10	5200	3	125
4	680	X/7343-43	T520X687M004A(1)E015	272	10	15	4100	3	105
4	680	X/7343-43	T520X687M004A(1)E035	272	10	35	2700	3	105
4	1000	X/7343-43	T530X108M004A(1)E006	400	8	6	6700	3	125
6.3	15	T/3528-12	T520T156M006A(1)E100	9.45	8	100	1000	3	105
6.3	10	P/2012-10	T529P106M006AAE200	18.9	6	200	354	3	105
6.3	22	P/2012-10	T529P226M006AAE150	22	6	150	408	3	105
6.3	22	P/2012-10	T529P226M006AAE200	22	6	200	354	3	105
6.3	22	A/3216-18	T520A226M006A(1)E090	13.86	8	90	1100	3	105
6.3	22	A/3216-18	T520A226M006A(1)E100	13.86	8	100	1100	3	105
6.3	22	T/3528-12	T520T226M006A(1)E100	13.86	8	100	1000	3	105
6.3	33	A/3216-18	T520A336M006A(1)E070	20.79	8	70	1300	3	105
VDC at 105°C	µF	KEMET/EIA	(See below for part options)	µA at 25°C Maximum/ 5 Minutes	% at 25°C 120 Hz Maximum	mΩ at 25°C 100 kHz Maximum	mA at +45°C 100 kHz	Reflow Temp ≤ 260°C	°C
Rated Voltage	Rated Capacitance	Case Code/ Case Size	KEMET Part Number	DC Leakage	DF	ESR	Maximum Allowable Ripple Current	MSL	Maximum Operating Temp

(1) To complete KEMET part number, insert T = 100% Matte Tin (Sn) Plated, H = Standard Solder coated (SnPb 5% Pb minimum), N = Non-Magnetic 100% Tin (Sn), M = Non-Magnetic (SnPb). Refer to Ordering Information for additional detail.

(2) To complete KEMET part number, insert M for ± 20% or K for ± 10%. Designates Capacitance tolerance.

Higher voltage ratings and tighter ESR may be substituted within the same size at KEMET's option. Voltage substitutions will be marked with the higher voltage rating. Substitutions can include better than series.

Part numbers marked in blue font are not recommended for new designs. Please use the T521 series instead.

Part numbers marked in orange font are not recommended for new designs. Please contact your KEMET representative for a replacement part.

^ Denotes the large reel (13") is not available.

Refer to Ordering Information for additional detail.

Table 1 – Ratings & Part Number Reference cont'd

Rated Voltage	Rated Capacitance	Case Code/ Case Size	KEMET Part Number	DC Leakage	DF	ESR	Maximum Allowable Ripple Current	MSL	Maximum Operating Temp
VDC at 105°C	µF	KEMET/EIA	(See below for part options)	µA at 25°C Maximum/ 5 Minutes	% at 25°C 120 Hz Maximum	mΩ at 25°C 100 kHz Maximum	mA at +45°C 100 kHz	Reflow Temp ≤ 260°C	°C
6.3	33	A/3216-18	T520A336M006A(1)E080	20.79	8	80	1200	3	105
6.3	33	A/3216-18	T520A336M006A(1)E120	20.79	8	120	1000	3	105
6.3	33	T/3528-12	T520T336M006A(1)E070	20.79	8	70	1200	3	105
6.3	33	B/3528-21	T520B336M006A(1)E025	20.79	8	25	2300	3	105
6.3	33	B/3528-21	T520B336M006A(1)E035	20.79	8	35	1900	3	105
6.3	33	B/3528-21	T520B336M006A(1)E040	20.79	8	40	1800	3	105
6.3	33	B/3528-21	T520B336M006A(1)E070	20.79	8	70	1300	3	105
6.3	33	B/3528-21	T525B336M006A(1)E080	20.79	8	80	1300	3	125
6.3	33	C/6032-28	T520C336M006A(1)E100	20.79	8	100	1300	3	105
6.3	47	P/2012-10	T529P476M006AAE200	29.61	6	200	354	3	105
6.3	47	P/2012-10	T529P476M006AAE150	29.6	6	150	408	3	105
6.3	47	I/3216-10	T527I476M006ATE200	29.6	6	200	548	3	105
6.3	47	A/3216-18	T520A476M006A(1)E150	29.61	8	150	900	3	105
6.3	47	T/3528-12	T520T476M006A(1)E040	29.61	8	40	1600	3	105
6.3	47	T/3528-12	T520T476M006A(1)E070	29.61	8	70	1200	3	105
6.3	47	T/3528-12	T525T476M006A(1)E080	29.61	8	80	1100	3	125
6.3	47	B/3528-21	T520B476M006A(1)E025	29.61	8	25	2300	3	105
6.3	47	B/3528-21	T520B476M006A(1)E035	29.61	8	35	1900	3	105
6.3	47	B/3528-21	T520B476M006A(1)E040	29.61	8	40	1800	3	105
6.3	47	B/3528-21	T520B476M006A(1)E070	29.61	8	70	1300	3	105
6.3	47	B/3528-21	T525B476M006A(1)E070	29.61	8	70	1300	3	125
6.3	47	B/3528-21	T525B476M006A(1)E080	29.61	8	80	1300	3	125
6.3	68	A/3216-18	T520A686M006A(1)E150	42.84	8	150	900	3	105
6.3	68	T/3528-12	T520T686M006A(1)E070	42.84	8	70	1200	3	105
6.3	68	T/3528-12	T520T686M006A(1)E150	42.84	8	150	800	3	105
6.3	68	B/3528-21	T520B686M006A(1)E025	42.84	8	25	2300	3	105
6.3	68	B/3528-21	T520B686M006A(1)E035	42.84	8	35	1900	3	105
6.3	68	B/3528-21	T520B686M006A(1)E040	42.84	8	40	1800	3	105
6.3	68	B/3528-21	T520B686M006A(1)E070	42.84	8	70	1300	3	105
6.3	68	B/3528-21	T525B686M006A(1)E080	42.84	8	80	1300	3	125
6.3	68	U/6032-15	T520U686M006A(1)E055	42.84	8	55	1600	3	105
6.3	68	U/6032-15	T520U686M006A(1)E070	42.84	8	70	1400	3	105
6.3	68	C/6032-28	T520C686M006A(1)E100	42.84	8	100	1300	3	105
6.3	100	I/3216-10	T527I107M006ATE200	63.0	8	200	775	3	105
6.3	100	I/3216-10	T527I107M006ATE100	63.0	8	100	775	3	105
6.3	100	I/3216-10	T527I107M006ATE070	63.0	8	70	1134	3	105
6.3	100	A/3216-18	T520A107M006ATE070	63	8	70	1035	3	105
6.3	100	A/3216-18	T520A107M006ATE045	63	8	45	1600	3	105
6.3	100	A/3216-18	T520A107M006ATE035	63	8	35	1500	3	105
6.3	100	A/3216-18	T520A107M006ATE025	63	8	25	1732	3	105
6.3	100	T/3528-12	T520T107M006APE070	63	8	70	1200	3	105
6.3	100	T/3528-12	T520T107M006APE055	63	8	55	1200	3	105
6.3	100	B/3528-21	T520B107M006A(1)E015	63	8	15	2900	3	105
VDC at 105°C	µF	KEMET/EIA	(See below for part options)	µA at 25°C Maximum/ 5 Minutes	% at 25°C 120 Hz Maximum	mΩ at 25°C 100 kHz Maximum	mA at +45°C 100 kHz	Reflow Temp ≤ 260°C	°C
Rated Voltage	Rated Capacitance	Case Code/ Case Size	KEMET Part Number	DC Leakage	DF	ESR	Maximum Allowable Ripple Current	MSL	Maximum Operating Temp

(1) To complete KEMET part number, insert T = 100% Matte Tin (Sn) Plated, H = Standard Solder coated (SnPb 5% Pb minimum), N = Non-Magnetic 100% Tin (Sn), M = Non-Magnetic (SnPb). Refer to Ordering Information for additional detail.

(2) To complete KEMET part number, insert M for ± 20% or K for ± 10%. Designates Capacitance tolerance.

Higher voltage ratings and tighter ESR may be substituted within the same size at KEMET's option. Voltage substitutions will be marked with the higher voltage rating. Substitutions can include better than series.

Part numbers marked in blue font are not recommended for new designs. Please use the T521 series instead.

Part numbers marked in orange font are not recommended for new designs. Please contact your KEMET representative for a replacement part.

^ Denotes the large reel (13") is not available.

Refer to Ordering Information for additional detail.

Table 1 – Ratings & Part Number Reference cont'd

Rated Voltage	Rated Capacitance	Case Code/ Case Size	KEMET Part Number	DC Leakage	DF	ESR	Maximum Allowable Ripple Current	MSL	Maximum Operating Temp
VDC at 105°C	µF	KEMET/EIA	(See below for part options)	µA at 25°C Maximum/ 5 Minutes	% at 25°C 120 Hz Maximum	mΩ at 25°C 100 kHz Maximum	mA at +45°C 100 kHz	Reflow Temp ≤ 260°C	°C
6.3	100	B/3528-21	T520B107M006A(1)E018	63	8	18	2700	3	105
6.3	100	B/3528-21	T520B107M006A(1)E025	63	8	25	2300	3	105
6.3	100	B/3528-21	T520B107M006A(1)E035	63	8	35	1900	3	105
6.3	100	B/3528-21	T520B107M006A(1)E040	63	8	40	1800	3	105
6.3	100	B/3528-21	T520B107M006A(1)E045	63	8	45	1700	3	105
6.3	100	B/3528-21	T520B107M006A(1)E070	63	8	70	1300	3	105
6.3	100	U/6032-15	T520U107M006A(1)E055	63	8	55	1600	3	105
6.3	100	W/7343-15	T520W107M006A(1)E040	63	10	40	2100	3	105
6.3	100	V/7343-19	T520V107M006A(1)E009	63	10	9	4600	3	105
6.3	100	V/7343-19	T520V107M006A(1)E012	63	10	12	3900	3	105
6.3	100	V/7343-19	T520V107M006A(1)E015	63	10	15	3500	3	105
6.3	100	V/7343-19	T520V107M006A(1)E045	63	10	45	2000	3	105
6.3	100	C/6032-28	T520C107M006A(1)E025	63	8	25	2600	3	105
6.3	100	C/6032-28	T520C107M006A(1)E045	63	8	45	1900	3	105
6.3	120	B/3528-21	T520B127M006A(1)E035	75.6	8	35	1900	3	105
6.3	150	I/3216-10	T529I157M006AAE200	283.5	10	200	548	3	105
6.3	150	M/3528-15	T520M157M006A(1)E035	94.5	8	35	1900	3	105
6.3	150	M/3528-15	T520M157M006A(1)E070	94.5	8	70	1300	3	105
6.3	150	M/3528-15	T520M157M006A(1)E150	94.5	8	150	900	3	105
6.3	150	M/3528-15	T520M157M006A(1)E200	94.5	8	200	800	3	105
6.3	150	B/3528-21	T520B157M006A(1)E025	94.5	8	25	2300	3	105
6.3	150	B/3528-21	T520B157M006A(1)E035	94.5	8	35	1900	3	105
6.3	150	B/3528-21	T520B157M006A(1)E045	94.5	8	45	1700	3	105
6.3	150	B/3528-21	T520B157M006A(1)E070	94.5	8	70	1300	3	105
6.3	150	T/3528-12	T523T157M006APE030	94.5	8	30	1870	3	105
6.3	150	T/3528-12	T520T157M006A(1)E035	94.5	8	35	1700	3	105
6.3	150	C/6032-28	T520C157M006A(1)E015	94.5	8	15	3300	3	105
6.3	150	C/6032-28	T520C157M006A(1)E025	94.5	8	25	2600	3	105
6.3	150	C/6032-28	T520C157M006A(1)E045	94.5	8	45	1900	3	105
6.3	150	C/6032-28	T520C157M006A(1)E055	94.5	8	55	1700	3	105
6.3	150	U/6032-15	T520U157M006A(1)E045	94.5	8	45	1700	3	105
6.3	150	U/6032-15	T520U157M006A(1)E055	94.5	8	55	1600	3	105
6.3	150	L/6032-19	T520L157M006A(1)E012	94.5	8	12	3500	3	105
6.3	150	L/6032-19	T520L157M006A(1)E025	94.5	8	25	2400	3	105
6.3	150	W/7343-15	T520W157M006A(1)E025	94.5	10	25	2700	3	105
6.3	150	W/7343-15	T520W157M006A(1)E040	94.5	10	40	2100	3	105
6.3	150	V/7343-19	T520V157M006A(1)E006	94.5	10	6	5600	3	105
6.3	150	V/7343-19	T520V157M006A(1)E007	94.5	10	7	5200	3	105
6.3	150	V/7343-19	T520V157M006A(1)E009	94.5	10	9	4600	3	105
6.3	150	V/7343-19	T520V157M006A(1)E012	94.5	10	12	3900	3	105
6.3	150	V/7343-19	T520V157M006A(1)E015	94.5	10	15	3500	3	105
6.3	150	V/7343-19	T520V157M006A(1)E018	94.5	10	18	3200	3	105
6.3	150	V/7343-19	T520V157M006A(1)E025	94.5	10	25	2700	3	105
VDC at 105°C	µF	KEMET/EIA	(See below for part options)	µA at 25°C Maximum/ 5 Minutes	% at 25°C 120 Hz Maximum	mΩ at 25°C 100 kHz Maximum	mA at +45°C 100 kHz	Reflow Temp ≤ 260°C	°C
Rated Voltage	Rated Capacitance	Case Code/ Case Size	KEMET Part Number	DC Leakage	DF	ESR	Maximum Allowable Ripple Current	MSL	Maximum Operating Temp

(1) To complete KEMET part number, insert T = 100% Matte Tin (Sn) Plated, H = Standard Solder coated (SnPb 5% Pb minimum), N = Non-Magnetic 100% Tin (Sn), M = Non-Magnetic (SnPb). Refer to Ordering Information for additional detail.

(2) To complete KEMET part number, insert M for ± 20% or K for ± 10%. Designates Capacitance tolerance.

Higher voltage ratings and tighter ESR may be substituted within the same size at KEMET's option. Voltage substitutions will be marked with the higher voltage rating. Substitutions can include better than series.

Part numbers marked in blue font are not recommended for new designs. Please use the T521 series instead.

Part numbers marked in orange font are not recommended for new designs. Please contact your KEMET representative for a replacement part.

^ Denotes the large reel (13") is not available.

Refer to Ordering Information for additional detail.

Table 1 – Ratings & Part Number Reference cont'd

Rated Voltage	Rated Capacitance	Case Code/ Case Size	KEMET Part Number	DC Leakage	DF	ESR	Maximum Allowable Ripple Current	MSL	Maximum Operating Temp
VDC at 105°C	µF	KEMET/EIA	(See below for part options)	µA at 25°C Maximum/ 5 Minutes	% at 25°C 120 Hz Maximum	mΩ at 25°C 100 kHz Maximum	mA at +45°C 100 kHz	Reflow Temp ≤ 260°C	°C
6.3	150	V/7343-19	T520V157M006A(1)E040	94.5	10	40	2200	3	105
6.3	150	V/7343-19	T520V157M006A(1)E045	94.5	10	45	2000	3	105
6.3	150	D/7343-31	T520D157M006A(1)E006	94.5	10	6	6100	3	105
6.3	150	D/7343-31	T520D157M006A(1)E007	94.5	10	7	5700	3	105
6.3	150	D/7343-31	T520D157M006A(1)E015	94.5	10	15	3900	3	105
6.3	150	D/7343-31	T520D157M006A(1)E025	94.5	10	25	3000	3	105
6.3	150	D/7343-31	T525D157M006A(1)E025	94.5	10	25	3000	3	125
6.3	150	D/7343-31	T520D157M006A(1)E055	94.5	10	55	2000	3	105
6.3	220	B/3528-21	T520B227M006A(1)E025	138.6	8	25	2300	3	105
6.3	220	B/3528-21	T520B227M006A(1)E035	138.6	8	35	1900	3	105
6.3	220	B/3528-21	T520B227M006A(1)E045	138.6	8	45	1700	3	105
6.3	220	B/3528-21	T520B227M006A(1)E070	138.6	8	70	1300	3	105
6.3	220	C/6032-28	T520C227M006A(1)E015	138.6	8	15	3300	3	105
6.3	220	C/6032-28	T520C227M006A(1)E018	138.6	8	18	3000	3	105
6.3	220	C/6032-28	T520C227M006A(1)E025	138.6	8	25	2600	3	105
6.3	220	C/6032-28	T520C227M006A(1)E045	138.6	8	45	1900	3	105
6.3	220	V/7343-19	T520V227M006A(1)E007	138.6	10	7	5200	3	105
6.3	220	V/7343-19	T520V227M006A(1)E009	138.6	10	9	4600	3	105
6.3	220	V/7343-19	T520V227M006A(1)E012	138.6	10	12	3900	3	105
6.3	220	V/7343-19	T520V227M006A(1)E015	138.6	10	15	3500	3	105
6.3	220	V/7343-19	T520V227M006A(1)E018	138.6	10	18	3200	3	105
6.3	220	V/7343-19	T520V227M006A(1)E025	138.6	10	25	2700	3	105
6.3	220	V/7343-19	T520V227M006A(1)E040	138.6	10	40	2200	3	105
6.3	220	D/7343-31	T530D227M006A(1)E005	138.6	8	5	7100	3	125
6.3	220	D/7343-31	T520D227M006A(1)E006	138.6	10	6	6100	3	105
6.3	220	D/7343-31	T530D227M006A(1)E006	138.6	8	6	6500	3	125
6.3	220	D/7343-31	T520D227M006A(1)E007	138.6	10	7	5700	3	105
6.3	220	D/7343-31	T520D227M006A(1)E009	138.6	10	9	5000	3	105
6.3	220	D/7343-31	T520D227M006A(1)E015	138.6	10	15	3900	3	105
6.3	220	D/7343-31	T520D227M006A(1)E018	138.6	10	18	3500	3	105
6.3	220	D/7343-31	T520D227M006A(1)E025	138.6	10	25	3000	3	105
6.3	220	D/7343-31	T525D227M006A(1)E025	138.6	10	25	3000	3	125
6.3	220	D/7343-31	T520D227M006A(1)E040	138.6	10	40	2400	3	105
6.3	220	D/7343-31	T520D227M006A(1)E050	138.6	10	50	2100	3	105
6.3	330	B/3528-21	T520B337M006A(1)E040	207.9	8	40	1800	3	85
6.3	330	B/3528-21	T520B337M006A(1)E070	208	8	70	1300	3	85
6.3	330	V/7343-19	T520V337M006A(1)E015	207.9	10	15	3500	3	105
6.3	330	V/7343-19	T520V337M006A(1)E018	207.9	10	18	3200	3	105
6.3	330	V/7343-19	T520V337M006A(1)E025	207.9	10	25	2700	3	105
6.3	330	V/7343-19	T520V337M006A(1)E040	207.9	10	40	2200	3	105
6.3	330	V/7343-19	T520V337M006A(1)E045	207.9	10	45	2000	3	105
6.3	330	D/7343-31	T530D337M006A(1)E006	207.9	8	6	6500	3	125
6.3	330	D/7343-31	T520D337M006A(1)E009	207.9	10	9	5000	3	105
VDC at 105°C	µF	KEMET/EIA	(See below for part options)	µA at 25°C Maximum/ 5 Minutes	% at 25°C 120 Hz Maximum	mΩ at 25°C 100 kHz Maximum	mA at +45°C 100 kHz	Reflow Temp ≤ 260°C	°C
Rated Voltage	Rated Capacitance	Case Code/ Case Size	KEMET Part Number	DC Leakage	DF	ESR	Maximum Allowable Ripple Current	MSL	Maximum Operating Temp

(1) To complete KEMET part number, insert T = 100% Matte Tin (Sn) Plated, H = Standard Solder coated (SnPb 5% Pb minimum), N = Non-Magnetic 100% Tin (Sn), M = Non-Magnetic (SnPb). Refer to Ordering Information for additional detail.

(2) To complete KEMET part number, insert M for ± 20% or K for ± 10%. Designates Capacitance tolerance.

Higher voltage ratings and tighter ESR may be substituted within the same size at KEMET's option. Voltage substitutions will be marked with the higher voltage rating. Substitutions can include better than series.

Part numbers marked in blue font are not recommended for new designs. Please use the T521 series instead.

Part numbers marked in orange font are not recommended for new designs. Please contact your KEMET representative for a replacement part.

^ Denotes the large reel (13") is not available.

Refer to Ordering Information for additional detail.

Table 1 – Ratings & Part Number Reference cont'd

Rated Voltage	Rated Capacitance	Case Code/ Case Size	KEMET Part Number	DC Leakage	DF	ESR	Maximum Allowable Ripple Current	MSL	Maximum Operating Temp
VDC at 105°C	µF	KEMET/EIA	(See below for part options)	µA at 25°C Maximum/ 5 Minutes	% at 25°C 120 Hz Maximum	mΩ at 25°C 100 kHz Maximum	mA at +45°C 100 kHz	Reflow Temp ≤ 260°C	°C
6.3	330	D/7343-31	T520D337M006A(1)E010	207.9	10	10	4700	3	105
6.3	330	D/7343-31	T530D337M006A(1)E010	207.9	8	10	5000	3	125
6.3	330	D/7343-31	T520D337M006A(1)E015	207.9	10	15	3900	3	105
6.3	330	D/7343-31	T520D337M006A(1)E018	207.9	10	18	3500	3	105
6.3	330	D/7343-31	T520D337M006A(1)E025	207.9	10	25	3000	3	105
6.3	330	D/7343-31	T525D337M006A(1)E025	207.9	10	25	3000	3	125
6.3	330	D/7343-31	T520D337M006A(1)E040	207.9	10	40	2400	3	105
6.3	330	D/7343-31	T525D337M006A(1)E040	207.9	10	40	2400	3	125
6.3	330	D/7343-31	T520D337M006A(1)E045	207.9	10	45	2200	3	105
6.3	330	Y/7343-40	T530Y337M006A(1)E005	207.9	8	5	7300	3	125
6.3	330	Y/7343-40	T530Y337M006A(1)E006	207.9	8	6	6600	3	125
6.3	330	Y/7343-40	T520Y337M006A(1)E010	207.9	10	10	4900	3	105
6.3	330	Y/7343-40	T530Y337M006A(1)E010	207.9	8	10	5100	3	125
6.3	330	Y/7343-40	T520Y337M006A(1)E015	207.9	10	15	4000	3	105
6.3	330	Y/7343-40	T520Y337M006A(1)E025	207.9	10	25	3100	3	105
6.3	330	Y/7343-40	T520Y337M006A(1)E040	207.9	10	40	2500	3	105
6.3	470	W/7343-15	T520W477M006A(1)E055	296.1	10	55	1800	3	85
6.3	470	W/7343-15	T520W477M006A(1)E035	296.1	9	35	2300	3	85
6.3	470	V/7343-19	T520V477M006A(1)E055	296.1	10	55	1800	3	105
6.3	470	V/7343-19	T520V477M006A(1)E035	296.1	10	35	2300	3	105
6.3	470	Y/7343-40	T530Y477M006A(1)E005	296.1	8	5	7300	3	125
6.3	470	Y/7343-40	T520Y477M006A(1)E010	296.1	10	10	4900	3	105
6.3	470	Y/7343-40	T520Y477M006A(1)E015	296.1	10	15	4000	3	105
6.3	470	Y/7343-40	T520Y477M006A(1)E018	296.1	10	18	3700	3	105
6.3	470	Y/7343-40	T520Y477M006A(1)E025	296.1	10	25	3100	3	105
6.3	470	Y/7343-40	T520Y477M006A(1)E035	296.1	10	35	2600	3	105
6.3	470	Y/7343-40	T525Y477M006A(1)E035	296.1	10	35	2600	3	125
6.3	470	D/7343-31	T520D477M006A(1)E015	296.1	10	15	3900	3	105
6.3	470	D/7343-31	T520D477M006A(1)E025	296.1	10	25	3000	3	105
6.3	470	D/7343-31	T520D477M006A(1)E030	296.1	10	30	2700	3	105
6.3	470	X/7343-43	T530X477M006A(1)E004	296.1	8	4	8200	3	125
6.3	470	X/7343-43	T530X477M006A(1)E005	296.1	8	5	7300	3	125
6.3	470	X/7343-43	T530X477M006A(1)E006	296.1	8	6	6700	3	125
6.3	470	X/7343-43	T520X477M006A(1)E010	296.1	10	10	5000	3	105
6.3	470	X/7343-43	T530X477M006A(1)E010	296.1	8	10	5200	3	125
6.3	470	X/7343-43	T520X477M006A(1)E018	296.1	10	18	3700	3	105
6.3	470	X/7343-43	T520X477M006A(1)E035	296.1	10	35	2700	3	105
6.3	470	X/7343-43	T520X477M006A(1)E040	296.1	10	40	2500	3	105
6.3	680	Y/7343-40	T520Y687M006A(1)E025	428.4	10	25	3100	3	105
6.3	680	X/7343-43	T530X687M006A(1)E010	428.4	8	10	5200	3	125
6.3	680	X/7343-43	T530X687M006A(1)E018	428.4	8	18	3900	3	125
6.3	680	X/7343-43	T520X687M006A(1)E025	428.4	10	25	3100	3	105
6.3	680	X/7343-43	T520X687M006A(1)E018	428	10	18	3700	3	105
VDC at 105°C	µF	KEMET/EIA	(See below for part options)	µA at 25°C Maximum/ 5 Minutes	% at 25°C 120 Hz Maximum	mΩ at 25°C 100 kHz Maximum	mA at +45°C 100 kHz	Reflow Temp ≤ 260°C	°C
Rated Voltage	Rated Capacitance	Case Code/ Case Size	KEMET Part Number	DC Leakage	DF	ESR	Maximum Allowable Ripple Current	MSL	Maximum Operating Temp

(1) To complete KEMET part number, insert T = 100% Matte Tin (Sn) Plated, H = Standard Solder coated (SnPb 5% Pb minimum), N = Non-Magnetic 100% Tin (Sn), M = Non-Magnetic (SnPb). Refer to Ordering Information for additional detail.

(2) To complete KEMET part number, insert M for ± 20% or K for ± 10%. Designates Capacitance tolerance.

Higher voltage ratings and tighter ESR may be substituted within the same size at KEMET's option. Voltage substitutions will be marked with the higher voltage rating. Substitutions can include better than series.

Part numbers marked in blue font are not recommended for new designs. Please use the T521 series instead.

Part numbers marked in orange font are not recommended for new designs. Please contact your KEMET representative for a replacement part.

^ Denotes the large reel (13") is not available.

Refer to Ordering Information for additional detail.

Table 1 – Ratings & Part Number Reference cont'd

Rated Voltage	Rated Capacitance	Case Code/ Case Size	KEMET Part Number	DC Leakage	DF	ESR	Maximum Allowable Ripple Current	MSL	Maximum Operating Temp
VDC at 105°C	µF	KEMET/EIA	(See below for part options)	µA at 25°C Maximum/ 5 Minutes	% at 25°C 120 Hz Maximum	mΩ at 25°C 100 kHz Maximum	mA at +45°C 100 kHz	Reflow Temp ≤ 260°C	°C
6.3	680	J/7360-15	T523J687M006APE070	428	10	70	1700	3	85
6.3	1000	H/7360-20	T520H108M006A(1)E055	630	20	55	1800	3	85
6.3	1200	H/7360-20	T520H128M006A(1)E070	756	20	70	1200	3	85
6.3	1500	H/7360-20	T520H158M006A(1)E055	945	20	55	1800	3	85
8	22	T/3528-12	T520T226M008A(1)E070	17.6	8	70	1200	3	105
8	33	T/3528-12	T520T336M008A(1)E070	26.4	8	70	1200	3	105
8	33	T/3528-12	T520T336M008A(1)E080	26.4	8	80	1100	3	105
8	33	T/3528-12	T525T336M008A(1)E080	26.4	8	80	1100	3	125
8	33	B/3528-21	T520B336M008A(1)E025	26.4	8	25	2300	3	105
8	33	B/3528-21	T520B336M008A(1)E035	26.4	8	35	1900	3	105
8	33	B/3528-21	T520B336M008A(1)E040	26.4	8	40	1800	3	105
8	33	B/3528-21	T520B336M008A(1)E070	26.4	8	70	1300	3	105
8	33	U/6032-15	T520U336M008A(1)E070	26.4	8	70	1400	3	105
8	47	B/3528-21	T520B476M008A(1)E035	37.6	8	35	1900	3	105
8	47	B/3528-21	T520B476M008A(1)E070	37.6	8	70	1300	3	105
8	82	C/6032-28	T520C826M008A(1)E025	65.6	8	25	2600	3	105
8	82	C/6032-28	T520C826M008A(1)E045	65.6	8	45	1900	3	105
8	150	D/7343-31	T520D157M008A(1)E025	120	10	25	3000	3	105
8	150	D/7343-31	T520D157M008A(1)E040	120	10	40	2400	3	105
8	150	D/7343-31	T520D157M008A(1)E055	120	10	55	2000	3	105
8	150	V/7343-19	T520V157M008A(1)E040	120	10	40	2200	3	105
10	10	P/2012-10	T529P106M010AAE200	30	6	200	354	3	105
10	10	A/3216-18	T520A106M010A(1)E080	10	8	80	1200	3	105
10	10	A/3216-18	T525A106M010A(1)E080	10	8	80	1200	3	125
10	15	A/3216-18	T520A156M010A(1)E080	15	8	80	1200	3	105
10	22	P/2012-10	T529P226M010AAE150	66	6	150	408	3	105
10	22	P/2012-10	T529P226M010AAE200	66	6	200	354	3	105
10	22	I/3216-10	T527I226M010ATE200	22	8	200	548	3	105
10	22	A/3216-18	T520A226M010A(1)E080	22	8	80	1200	3	105
10	22	B/3528-21	T525B226M010A(1)E080	22	8	80	1300	3	125
10	33	I/3216-10	T527I336M010ATE200	33	6	200	548	3	105
10	33	T/3528-12	T520T336M010A(1)E040	33	8	40	1600	3	105
10	33	T/3528-12	T520T336M010A(1)E070	33	8	70	1200	3	105
10	33	T/3528-12	T520T336M010A(1)E080	33	8	80	1100	3	105
10	33	T/3528-12	T525T336M010A(1)E080	33	8	80	1100	3	125
10	33	B/3528-21	T520B336M010A(1)E025	33	8	25	2300	3	105
10	33	B/3528-21	T520B336M010A(1)E035	33	8	35	1900	3	105
10	33	B/3528-21	T520B336M010A(1)E040	33	8	40	1800	3	105
10	33	B/3528-21	T520B336M010A(1)E070	33	8	70	1300	3	105
10	33	B/3528-21	T525B336M010A(1)E080	33	8	80	1300	3	125
10	33	U/6032-15	T520U336M010A(1)E070	33	8	70	1400	3	105
10	47	P/2012-10	T529P476M010AAE200	141	6	200	354	3	105
10	47	I/3216-10	T527I476M010ATE200	47	6	200	548	3	105
VDC at 105°C	µF	KEMET/EIA	(See below for part options)	µA at 25°C Maximum/ 5 Minutes	% at 25°C 120 Hz Maximum	mΩ at 25°C 100 kHz Maximum	mA at +45°C 100 kHz	Reflow Temp ≤ 260°C	°C
Rated Voltage	Rated Capacitance	Case Code/ Case Size	KEMET Part Number	DC Leakage	DF	ESR	Maximum Allowable Ripple Current	MSL	Maximum Operating Temp

(1) To complete KEMET part number, insert T = 100% Matte Tin (Sn) Plated, H = Standard Solder coated (SnPb 5% Pb minimum), N = Non-Magnetic 100% Tin (Sn), M = Non-Magnetic (SnPb). Refer to Ordering Information for additional detail.

(2) To complete KEMET part number, insert M for ± 20% or K for ± 10%. Designates Capacitance tolerance.

Higher voltage ratings and tighter ESR may be substituted within the same size at KEMET's option. Voltage substitutions will be marked with the higher voltage rating. Substitutions can include better than series.

Part numbers marked in blue font are not recommended for new designs. Please use the T521 series instead.

Part numbers marked in orange font are not recommended for new designs. Please contact your KEMET representative for a replacement part.

^ Denotes the large reel (13") is not available.

Refer to Ordering Information for additional detail.

Table 1 – Ratings & Part Number Reference cont'd

Rated Voltage	Rated Capacitance	Case Code/ Case Size	KEMET Part Number	DC Leakage	DF	ESR	Maximum Allowable Ripple Current	MSL	Maximum Operating Temp
VDC at 105°C	µF	KEMET/EIA	(See below for part options)	µA at 25°C Maximum/ 5 Minutes	% at 25°C 120 Hz Maximum	mΩ at 25°C 100 kHz Maximum	mA at +45°C 100 kHz	Reflow Temp ≤ 260°C	°C
10	47	B/3528-21	T520B476M010A(1)E035	47	8	35	1900	3	105
10	47	B/3528-21	T520B476M010A(1)E070	47	8	70	1300	3	105
10	47	U/6032-15	T520U476M010A(1)E055	47	8	55	1600	3	105
10	47	C/6032-28	T520C476M010A(1)E100	47	8	100	1300	3	105
10	68	U/6032-15	T520U686M010A(1)E055	68	8	55	1600	3	105
10	68	W/7343-15	T520W686M010A(1)E025	68	10	25	2700	3	105
10	68	W/7343-15	T520W686M010A(1)E040	68	10	40	2100	3	105
10	68	C/6032-28	T520C686M010A(1)E045	68	8	45	1900	3	105
10	68	V/7343-19	T520V686M010A(1)E025	68	10	25	2700	3	105
10	68	V/7343-19	T520V686M010A(1)E040	68	10	40	2200	3	105
10	68	V/7343-19	T520V686M010A(1)E045	68	10	45	2000	3	105
10	68	V/7343-19	T520V686M010A(1)E060	68	10	60	1800	3	105
10	68	V/7343-19	T520V686M010A(1)E100	68	10	100	1400	3	105
10	68	D/7343-31	T520D686M010A(1)E100	68	10	100	1500	3	105
10	100	B/3528-21	T520B107M010A(1)E070	100	8	70	1300	3	105
10	100	C/6032-28	T520C107M010A(1)E025	100	8	25	2600	3	105
10	100	C/6032-28	T520C107M010A(1)E045	100	8	45	1900	3	105
10	100	L/6032-19	T520L107M010A(1)E025	100	8	25	2400	3	105
10	100	W/7343-15	T520W107M010A(1)E040	100	10	40	2100	3	105
10	100	V/7343-19	T520V107M010A(1)E018	100	10	18	3200	3	105
10	100	V/7343-19	T520V107M010A(1)E025	100	10	25	2700	3	105
10	100	V/7343-19	T520V107M010A(1)E045	100	10	45	2000	3	105
10	100	V/7343-19	T520V107M010A(1)E050	100	10	50	1900	3	105
10	100	V/7343-19	T520V107M010A(1)E055	100	10	55	1800	3	105
10	100	D/7343-31	T520D107M010A(1)E018	100	10	18	3500	3	105
10	100	D/7343-31	T525D107M010A(1)E025	100	10	25	3000	3	125
10	100	D/7343-31	T520D107M010A(1)E055	100	10	55	2000	3	105
10	100	D/7343-31	T525D107M010A(1)E055	100	10	55	2000	3	125
10	100	D/7343-31	T520D107M010A(1)E080	100	10	80	1700	3	105
10	150	C/6032-28	T520C157M010A(1)E055	150	8	55	1700	3	105
10	150	V/7343-19	T520V157M010A(1)E018	150	10	18	3200	3	105
10	150	V/7343-19	T520V157M010A(1)E025	150	10	25	2700	3	105
10	150	V/7343-19	T520V157M010A(1)E040	150	10	40	2200	3	105
10	150	D/7343-31	T530D157M010A(1)E005	150	8	5	7100	3	125
10	150	D/7343-31	T530D157M010A(1)E006	150	8	6	6500	3	125
10	150	D/7343-31	T530D157M010A(1)E010	150	8	10	5000	3	125
10	150	D/7343-31	T520D157M010A(1)E015	150	10	15	3900	3	105
10	150	D/7343-31	T520D157M010A(1)E018	150	10	18	3500	3	105
10	150	D/7343-31	T520D157M010A(1)E025	150	10	25	3000	3	105
10	150	D/7343-31	T525D157M010A(1)E025	150	10	25	3000	3	125
10	150	D/7343-31	T520D157M010A(1)E040	150	10	40	2400	3	105
10	150	D/7343-31	T520D157M010A(1)E055	150	10	55	2000	3	105
10	150	D/7343-31	T525D157M010A(1)E055	150	10	55	2000	3	125
VDC at 105°C	µF	KEMET/EIA	(See below for part options)	µA at 25°C Maximum/ 5 Minutes	% at 25°C 120 Hz Maximum	mΩ at 25°C 100 kHz Maximum	mA at +45°C 100 kHz	Reflow Temp ≤ 260°C	°C
Rated Voltage	Rated Capacitance	Case Code/ Case Size	KEMET Part Number	DC Leakage	DF	ESR	Maximum Allowable Ripple Current	MSL	Maximum Operating Temp

(1) To complete KEMET part number, insert T = 100% Matte Tin (Sn) Plated, H = Standard Solder coated (SnPb 5% Pb minimum), N = Non-Magnetic 100% Tin (Sn), M = Non-Magnetic (SnPb). Refer to Ordering Information for additional detail.

(2) To complete KEMET part number, insert M for ± 20% or K for ± 10%. Designates Capacitance tolerance.

Higher voltage ratings and tighter ESR may be substituted within the same size at KEMET's option. Voltage substitutions will be marked with the higher voltage rating. Substitutions can include better than series.

Part numbers marked in blue font are not recommended for new designs. Please use the T521 series instead.

Part numbers marked in orange font are not recommended for new designs. Please contact your KEMET representative for a replacement part.

^ Denotes the large reel (13") is not available.

Refer to Ordering Information for additional detail.

Table 1 – Ratings & Part Number Reference cont'd

Rated Voltage	Rated Capacitance	Case Code/ Case Size	KEMET Part Number	DC Leakage	DF	ESR	Maximum Allowable Ripple Current	MSL	Maximum Operating Temp
VDC at 105°C	µF	KEMET/EIA	(See below for part options)	µA at 25°C Maximum/ 5 Minutes	% at 25°C 120 Hz Maximum	mΩ at 25°C 100 kHz Maximum	mA at +45°C 100 kHz	Reflow Temp ≤ 260°C	°C
10	150	Y/7343-40	T520Y157M010A(1)E015	150	10	15	4000	3	105
10	150	Y/7343-40	T520Y157M010A(1)E018	150	10	18	3700	3	105
10	150	Y/7343-40	T520Y157M010A(1)E025	150	10	25	3100	3	105
10	220	V/7343-19	T520V227M010A(1)E045	220	10	45	2000	3	105
10	220	V/7343-19	T520V227M010A(1)E025	220	10	25	2700	3	105
10	220	D/7343-31	T530D227M010A(1)E006	220	8	6	6500	3	125
10	220	D/7343-31	T530D227M010A(1)E010	220	8	10	5000	3	125
10	220	D/7343-31	T520D227M010A(1)E018	220	10	18	3500	3	105
10	220	D/7343-31	T520D227M010A(1)E025	220	10	25	3000	3	105
10	220	D/7343-31	T525D227M010A(1)E025	220	10	25	3000	3	125
10	220	D/7343-31	T520D227M010A(1)E040	220	10	40	2400	3	105
10	220	Y/7343-40	T530Y227M010A(1)E006	220	8	6	6600	3	125
10	220	Y/7343-40	T520Y227M010A(1)E040	220	10	40	2500	3	105
10	330	Y/7343-40	T520Y337M010A(1)E015	330	10	15	4000	3	105
10	330	Y/7343-40	T520Y337M010A(1)E025	330	10	25	3100	3	105
10	330	Y/7343-40	T520Y337M010A(1)E035	330	10	35	2600	3	105
10	330	Y/7343-40	T525Y337M010A(1)E035	330	10	35	2600	3	125
10	330	X/7343-43	T530X337M010A(1)E004	330	8	4	8200	3	125
10	330	X/7343-43	T530X337M010A(1)E005	330	8	5	7300	3	125
10	330	X/7343-43	T530X337M010A(1)E006	330	8	6	6700	3	125
10	330	X/7343-43	T520X337M010A(1)E010	330	10	10	5000	3	105
10	330	X/7343-43	T530X337M010A(1)E010	330	8	10	5200	3	125
10	330	X/7343-43	T520X337M010A(1)E025	330	10	25	3100	3	105
10	330	X/7343-43	T520X337M010A(1)E035	330	10	35	2700	3	105
10	330	J/7360-15	T523J337M010APE070	330	10	70	1700	3	85
10	470	J/7360-15	T523J477M010APE070	470	10	70	1700	3	85
10	820	H/7360-20	T520H827M010A(1)E070	820	20	70	1200	3	85
10	330	X/7343-43	T520X337M010A(1)E040	330	10	40	2500	3	105
11	47	Q/7343-12	T520Q476M011A(1)E040	52	10	40	4500	3	105
12.5	10	T/3528-12	T520T106M12RA(1)E150	12.5	8	150	800	3	105
12.5	15	T/3528-12	T520T156M12RA(1)E080	18.75	8	80	1100	3	105
12.5	47	T/3528-12	T521T476M12RA(1)E090	58.8	8	90	1100	3	105
16	10	B/3528-21	T520B106M016A(1)E100	16	8	100	1100	3	105
16	10	B/3528-21	T521B106M016A(1)E100	16	8	100	1100	3	125
16	15	B/3528-21	T521B156M016A(1)E090	24	8	90	1200	3	105
16	22	B/3528-21	T521B226M016A(1)E090	35.2	8	90	1200	3	105
16	22	C/6032-28	T520C226M016A(1)E080	35.2	8	80	1400	3	105
16	33	T/3528-12	T521T336M016A(1)E045	52.8	8	45	1500	3	105
16	33	T/3528-12	T521T336M016A(1)E050	52.8	10	50	1400	3	105
16	33	B/3528-21	T521B336M016A(1)E070	52.8	8	70	1300	3	105
16	33	B/3528-21	T521B336M016A(1)E090	52.8	8	90	1200	3	105
16	33	B/3528-21	T525B336M016A(1)E070	52.8	8	70	1300	3	125
16	33	B/3528-21	T525B336M016A(1)E090	52.8	8	90	1200	3	125
VDC at 105°C	µF	KEMET/EIA	(See below for part options)	µA at 25°C Maximum/ 5 Minutes	% at 25°C 120 Hz Maximum	mΩ at 25°C 100 kHz Maximum	mA at +45°C 100 kHz	Reflow Temp ≤ 260°C	°C
Rated Voltage	Rated Capacitance	Case Code/ Case Size	KEMET Part Number	DC Leakage	DF	ESR	Maximum Allowable Ripple Current	MSL	Maximum Operating Temp

(1) To complete KEMET part number, insert T = 100% Matte Tin (Sn) Plated, H = Standard Solder coated (SnPb 5% Pb minimum), N = Non-Magnetic 100% Tin (Sn), M = Non-Magnetic (SnPb). Refer to Ordering Information for additional detail.

(2) To complete KEMET part number, insert M for ± 20% or K for ± 10%. Designates Capacitance tolerance.

Higher voltage ratings and tighter ESR may be substituted within the same size at KEMET's option. Voltage substitutions will be marked with the higher voltage rating. Substitutions can include better than series.

Part numbers marked in blue font are not recommended for new designs. Please use the T521 series instead.

Part numbers marked in orange font are not recommended for new designs. Please contact your KEMET representative for a replacement part.

^ Denotes the large reel (13") is not available.

Refer to Ordering Information for additional detail.

Table 1 – Ratings & Part Number Reference cont'd

Rated Voltage	Rated Capacitance	Case Code/ Case Size	KEMET Part Number	DC Leakage	DF	ESR	Maximum Allowable Ripple Current	MSL	Maximum Operating Temp
VDC at 105°C	µF	KEMET/EIA	(See below for part options)	µA at 25°C Maximum/ 5 Minutes	% at 25°C 120 Hz Maximum	mΩ at 25°C 100 kHz Maximum	mA at +45°C 100 kHz	Reflow Temp ≤ 260°C	°C
16	33	Q/7343-12	T521Q336M016A(1)E040	52.8	10	40	2500	3	105
16	33	W/7343-15	T520W336M016A(1)E045	52.8	10	45	2000	3	105
16	33	V/7343-19	T520V336M016A(1)E045	52.8	10	45	2000	3	105
16	33	V/7343-19	T520V336M016A(1)E060	52.8	10	60	1800	3	105
16	33	V/7343-19	T520V336M016A(1)E070	52.8	10	70	1600	3	105
16	47	W/7343-15	T521W476M016A(1)E040	75.2	10	40	2100	3	105
16	47	W/7343-15	T521W476M016A(1)E045	75.2	10	45	2000	3	105
16	47	V/7343-19	T521V476M016A(1)E040	75.2	10	40	2200	3	105
16	47	V/7343-19	T520V476M016A(1)E045	75.2	10	45	2000	3	105
16	47	V/7343-19	T521V476M016A(1)E055	75.2	10	55	1800	3	105
16	47	V/7343-19	T521V476M016A(1)E070	75.2	10	70	1600	3	105
16	47	V/7343-19	T521V476M016A(1)E080	75.2	10	80	1500	3	105
16	47	D/7343-31	T520D476M016A(1)E035	75.2	10	35	2500	3	105
16	47	D/7343-31	T525D476M016A(1)E035	75.2	10	35	2500	3	125
16	47	D/7343-31	T521D476M016A(1)E040	75.2	10	40	2400	3	105
16	47	D/7343-31	T521D476M016A(1)E045	75.2	10	45	2200	3	105
16	47	D/7343-31	T521D476M016A(1)E055	75.2	10	55	2000	3	105
16	47	D/7343-31	T525D476M016A(1)E065	75.2	10	65	1900	3	125
16	47	D/7343-31	T520D476M016A(1)E070	75.2	10	70	1800	3	105
16	47	D/7343-31	T521D476M016A(1)E070	75.2	10	70	1800	3	105
16	47	D/7343-31	T521D476M016A(1)E090	75.2	10	90	1600	3	105
16	68	W/7343-15	T523W686(2)016APE050	108.8	10	50	2820	3	105
16	68	W/7343-15	T523W686(2)016APE070	108.8	10	70	2376	3	105
16	68	W/7343-15	T523W686(2)016APE100	108.8	10	100	1988	3	105
16	68	V/7343-19	T521V686M016A(1)E040	108.8	10	40	2200	3	105
16	68	V/7343-19	T521V686M016A(1)E050	108.8	10	50	1900	3	105
16	68	V/7343-19	T521V686M016A(1)E090	108.8	10	90	1400	3	105
16	68	D/7343-31	T520D686M016A(1)E050	108.8	10	50	2100	3	105
16	100	W/7343-15	T523W107(2)016APE050	160	10	50	2820	3	105
16	100	W/7343-15	T523W107(2)016APE070	160	10	70	2376	3	105
16	100	W/7343-15	T523W107(2)016APE100	160	10	100	1988	3	105
16	100	V/7343-19	T521V107M016A(1)E040	160	10	40	2200	3	125
16	100	V/7343-19	T521V107M016A(1)E050	160	10	50	1900	3	125
16	100	D/7343-31	T521D107M016A(1)E050	160	10	50	2100	3	105
16	150	W/7343-15	T523W157(2)016APE050	240	10	50	2820	3	105
16	150	W/7343-15	T523W157(2)016APE070	240	10	70	2376	3	105
16	150	W/7343-15	T523W157(2)016APE100	240	10	100	1988	3	105
16	150	D/7343-31	T521D157M016A(1)E050	240	10	50	2100	3	105
16	150	D/7343-31	T521D157M016A(1)E040	240	10	40	2400	3	105
16	150	X/7343-43	T530X157M016A(1)E015	240	8	15	4200	3	125
16	150	X/7343-43	T530X157M016A(1)E025	240	8	25	3300	3	125
VDC at 105°C	µF	KEMET/EIA	(See below for part options)	µA at 25°C Maximum/ 5 Minutes	% at 25°C 120 Hz Maximum	mΩ at 25°C 100 kHz Maximum	mA at +45°C 100 kHz	Reflow Temp ≤ 260°C	°C
Rated Voltage	Rated Capacitance	Case Code/ Case Size	KEMET Part Number	DC Leakage	DF	ESR	Maximum Allowable Ripple Current	MSL	Maximum Operating Temp

(1) To complete KEMET part number, insert T = 100% Matte Tin (Sn) Plated, H = Standard Solder coated (SnPb 5% Pb minimum), N = Non-Magnetic 100% Tin (Sn), M = Non-Magnetic (SnPb). Refer to Ordering Information for additional detail.

(2) To complete KEMET part number, insert M for ± 20% or K for ± 10%. Designates Capacitance tolerance.

Higher voltage ratings and tighter ESR may be substituted within the same size at KEMET's option. Voltage substitutions will be marked with the higher voltage rating. Substitutions can include better than series.

Part numbers marked in blue font are not recommended for new designs. Please use the T521 series instead.

Part numbers marked in orange font are not recommended for new designs. Please contact your KEMET representative for a replacement part.

^ Denotes the large reel (13") is not available.

Refer to Ordering Information for additional detail.

Table 1 – Ratings & Part Number Reference cont'd

Rated Voltage	Rated Capacitance	Case Code/ Case Size	KEMET Part Number	DC Leakage	DF	ESR	Maximum Allowable Ripple Current	MSL	Maximum Operating Temp
VDC at 105°C	µF	KEMET/EIA	(See below for part options)	µA at 25°C Maximum/ 5 Minutes	% at 25°C 120 Hz Maximum	mΩ at 25°C 100 kHz Maximum	mA at +45°C 100 kHz	Reflow Temp ≤ 260°C	°C
16	150	X/7343-43	T520X157M016A(1)E040	240	10	40	2500	3	105
16	150	X/7343-43	T530X157M016A(1)E040	240	8	40	2600	3	125
16	150	X/7343-43	T521X157M016A(1)E080	240	10	80	1800	3	105
16	220	X/7343-43	T521X227M016A(1)E035	352	10	35	2700	3	125
16	220	X/7343-43	T521X227M016A(1)E050	352	10	50	2200	3	125
16	220	H/7360-20	T523H227M016APE070	352	10	70	2510	3	105
16	220	J/7360-15	T523J227M016APE070	352	10	70	2100	3	85
16	330	X/7343-43	T521X337M016A(1)E025	528	10	25	3100	3	125
16	330	X/7343-43	T521X337M016A(1)E050	528	10	50	2200	3	125
16	330	H/7360-20	T523H337M016APE070	528	10	70	2510	3	85
20	10	B/3528-21	T521B106M020A(1)E100	20	8	100	1100	3	105
20	15	B/3528-21	T521B156M020A(1)E090	30	10	90	1200	3	105
20	22	B/3528-21	T521B226M020A(1)E090	44	8	90	1200	3	105
20	22	V/7343-19	T520V226M020A(1)E040	44	10	40	2200	3	105
20	22	V/7343-19	T520V226M020A(1)E045	44	10	45	2000	3	105
20	22	V/7343-19	T520V226M020A(1)E090	44	10	90	1400	3	105
20	22	V/7343-19	T521V226M020A(1)E090	44	10	90	1400	3	125
20	47	W/7343-15	T521W476M020A(1)E040	94	9	40	2100	3	105
20	47	W/7343-15	T521W476M020A(1)E045	94	9	45	2000	3	105
20	47	V/7343-19	T521V476M020A(1)E090	94	10	90	1400	3	125
20	47	V/7343-19	T521V476M020A(1)E080	94	10	80	1500	3	125
20	47	V/7343-19	T521V476M020A(1)E055	94	10	55	1800	3	125
20	47	D/7343-31	T521D476M020A(1)E055	94	10	55	2000	3	125
20	47	D/7343-31	T521D476M020A(1)E040	94	10	40	2400	3	125
20	68	V/7343-19	T521V686M020A(1)E050	136	10	50	1900	3	105
20	100	V/7343-19	T521V107M020A(1)E055	200	10	55	1800	3	125
20	100	D/7343-31	T521D107M020A(1)E055	200	10	55	2000	3	105
25	4.7	P/2012-10	T529P475M025AAE300	35.3	10	300	289	3	105
25	10	B/3528-21	T521B106M025A(1)E100	25	8	100	1100	3	105
25	10	T/3528-12	T521T106M025A(1)E100	25	8	100	1000	3	125
25	10	T/3528-12	T521T106M025A(1)E060	25	8	60	1300	3	125
25	15	B/3528-21	T521B156M025A(1)E100	37.5	8	100	1100	3	105
25	15	V/7343-19	T520V156M025A(1)E090	37.5	10	90	1400	3	105
25	15	V/7343-19	T521V156M025A(1)E090	37.5	10	90	1400	3	105
25	15	V/7343-19	T521V156M025A(1)E040	37.5	10	40	2200	3	105
25	15	D/7343-31	T520D156M025A(1)E060	37.5	10	60	1900	3	105
25	15	D/7343-31	T520D156M025A(1)E080	37.5	10	80	1700	3	105
25	22	B/3528-21	T521B226M025A(1)E100	55	8	100	1100	3	105
25	22	W/7343-15	T521W226M025A(1)E040	55	10	40	2100	3	105
25	22	W/7343-15	T521W226M025A(1)E070	55	10	70	1400	3	105
25	22	V/7343-19	T521V226M025A(1)E040	55	10	40	2200	3	105
25	22	V/7343-19	T521V226M025A(1)E045	55	10	45	2000	3	105
25	22	V/7343-19	T521V226M025A(1)E060	55	10	60	1800	3	105
VDC at 105°C	µF	KEMET/EIA	(See below for part options)	µA at 25°C Maximum/ 5 Minutes	% at 25°C 120 Hz Maximum	mΩ at 25°C 100 kHz Maximum	mA at +45°C 100 kHz	Reflow Temp ≤ 260°C	°C
Rated Voltage	Rated Capacitance	Case Code/ Case Size	KEMET Part Number	DC Leakage	DF	ESR	Maximum Allowable Ripple Current	MSL	Maximum Operating Temp

(1) To complete KEMET part number, insert T = 100% Matte Tin (Sn) Plated, H = Standard Solder coated (SnPb 5% Pb minimum), N = Non-Magnetic 100% Tin (Sn), M = Non-Magnetic (SnPb). Refer to Ordering Information for additional detail.

(2) To complete KEMET part number, insert M for ± 20% or K for ± 10%. Designates Capacitance tolerance.

Higher voltage ratings and tighter ESR may be substituted within the same size at KEMET's option. Voltage substitutions will be marked with the higher voltage rating. Substitutions can include better than series.

Part numbers marked in blue font are not recommended for new designs. Please use the T521 series instead.

Part numbers marked in orange font are not recommended for new designs. Please contact your KEMET representative for a replacement part.

^ Denotes the large reel (13") is not available.

Refer to Ordering Information for additional detail.

Table 1 – Ratings & Part Number Reference cont'd

Rated Voltage	Rated Capacitance	Case Code/ Case Size	KEMET Part Number	DC Leakage	DF	ESR	Maximum Allowable Ripple Current	MSL	Maximum Operating Temp
VDC at 105°C	µF	KEMET/EIA	(See below for part options)	µA at 25°C Maximum/ 5 Minutes	% at 25°C 120 Hz Maximum	mΩ at 25°C 100 kHz Maximum	mA at +45°C 100 kHz	Reflow Temp ≤ 260°C	°C
25	22	V/7343-19	T521V226M025A(1)E090	55	10	90	1400	3	105
25	33	V/7343-19	T521V336M025A(1)E025	82.5	10	25	2700	3	105
25	33	V/7343-19	T521V336M025A(1)E060	82.5	10	60	1800	3	105
25	33	V/7343-19	T521V336M025A(1)E040	82.5	10	40	2200	3	105
25	33	D/7343-31	T521D336M025A(1)E040	82.5	10	40	2400	3	105
25	33	D/7343-31	T521D336M025A(1)E060	82.5	10	60	1900	3	105
25	47	D/7343-31	T521D476M025A(1)E065	117.5	10	65	1900	3	105
25	68	D/7343-31	T521D686M025A(1)E070	170	10	70	1800	3	105
25	100	D/7343-31	T521D107M025A(1)E040	250	10	40	2400	3	105
25	100	D/7343-31	T521D107M025A(1)E060	250	10	60	1900	3	105
25	100	X/7343-43	T521X107M025A(1)E030	250	10	30	2900	3	105
25	100	X/7343-43	T521X107M025A(1)E060	250	10	60	2000	3	105
35	3.3	B/3528-21	T521B335M035A(1)E150	11.6	8	150	900	3	105
35	3.3	B/3528-21	T521B335M035A(1)E200	11.6	8	200	800	3	105
35	4.7	B/3528-21	T521B475M035A(1)E150	16.5	8	150	900	3	105
35	4.7	B/3528-21	T521B475M035A(1)E200	16.5	8	200	800	3	105
35	6.8	T/3528-12	T521T685M035APE090	23.8	10	90	1100	3	125
35	6.8	B/3528-21	T521B685M035A(1)E150	23.8	8	150	900	3	105
35	6.8	B/3528-21	T521B685M035A(1)E200	23.8	8	200	800	3	105
35	10	B/3528-21	T521B106M035A(1)E150	35	8	150	900	3	105
35	10	B/3528-21	T521B106M035A(1)E200	35	8	200	800	3	105
35	10	V/7343-19	T521V106M035A(1)E120	35	10	120	1200	3	125
35	15	V/7343-19	T521V156M035A(1)E100	52.5	10	100	1400	3	125
35	15	V/7343-19	T521V156M035A(1)E125	52.5	10	125	1200	3	125
35	22	D/7343-31	T521D226M035A(1)E040	77	10	40	2400	3	125
35	22	D/7343-31	T521D226M035A(1)E060	77	10	60	1900	3	125
35	33	D/7343-31	T521D336M035A(1)E065	115.5	10	65	1900	3	125
35	47	X/7343-43	T521X476M035A(1)E030	164.5	10	30	2900	3	125
35	47	X/7343-43	T521X476M035A(1)E070	164.5	10	70	1900	3	125
35	47	W/7343-15	T523W476(2)035APE090	164.5	10	90	2100	3	85
35	47	W/7343-15	T523W476(2)035APE100	164.5	10	100	1988	3	85
50	0.68	B/3528-21	T521B684M050A(1)E200	3.4	8	200	800	3	105
50	1	B/3528-21	T521B105M050A(1)E200	5	8	200	800	3	105
50	1.5	B/3528-21	T521B155M050A(1)E200	7.5	8	200	800	3	105
50	2.2	B/3528-21	T521B225M050A(1)E200	11	8	200	800	3	105
50	5.6	D/7343-31	T521D565M050A(1)E070	28	10	70	1800	3	125
50	5.6	D/7343-31	T521D565M050A(1)E090	28	10	90	1600	3	125
50	5.6	V/7343-19	T521V565M050A(1)E070	28	10	70	1800	3	125
50	5.6	V/7343-19	T521V565M050A(1)E090	28	10	90	1600	3	125
50	6.8	D/7343-31	T521D685M050A(1)E070	34	10	70	1800	3	125
50	6.8	D/7343-31	T521D685M050A(1)E090	34	10	90	1600	3	125
50	6.8	V/7343-19	T521V685M050A(1)E070	34	10	70	1800	3	125
50	6.8	V/7343-19	T521V685M050A(1)E090	34	10	90	1600	3	125
VDC at 105°C	µF	KEMET/EIA	(See below for part options)	µA at 25°C Maximum/ 5 Minutes	% at 25°C 120 Hz Maximum	mΩ at 25°C 100 kHz Maximum	mA at +45°C 100 kHz	Reflow Temp ≤ 260°C	°C
Rated Voltage	Rated Capacitance	Case Code/ Case Size	KEMET Part Number	DC Leakage	DF	ESR	Maximum Allowable Ripple Current	MSL	Maximum Operating Temp

(1) To complete KEMET part number, insert T = 100% Matte Tin (Sn) Plated, H = Standard Solder coated (SnPb 5% Pb minimum), N = Non-Magnetic 100% Tin (Sn), M = Non-Magnetic (SnPb). Refer to Ordering Information for additional detail.

(2) To complete KEMET part number, insert M for ± 20% or K for ± 10%. Designates Capacitance tolerance.

Higher voltage ratings and tighter ESR may be substituted within the same size at KEMET's option. Voltage substitutions will be marked with the higher voltage rating. Substitutions can include better than series.

Part numbers marked in blue font are not recommended for new designs. Please use the T521 series instead.

Part numbers marked in orange font are not recommended for new designs. Please contact your KEMET representative for a replacement part.

^ Denotes the large reel (13") is not available.

Refer to Ordering Information for additional detail.

Table 1 – Ratings & Part Number Reference cont'd

Rated Voltage	Rated Capacitance	Case Code/ Case Size	KEMET Part Number	DC Leakage	DF	ESR	Maximum Allowable Ripple Current	MSL	Maximum Operating Temp
VDC at 105°C	µF	KEMET/EIA	(See below for part options)	µA at 25°C Maximum/ 5 Minutes	% at 25°C 120 Hz Maximum	mΩ at 25°C 100 kHz Maximum	mA at +45°C 100 kHz	Reflow Temp ≤ 260°C	°C
50	10	D/7343-31	T521D106M050A(1)E090	50	10	90	1600	3	125
50	10	D/7343-31	T521D106M050A(1)E120	50	10	120	1369	3	125
50	10	V/7343-19	T521V106M050A(1)E090	50	10	90	1600	3	125
50	18	D/7343-31	T521D186M050A(1)E090	90	10	90	1600	3	125
50	18	X/7343-43	T521X186M050A(1)E070	90	10	70	1900	3	125
50	18	X/7343-43	T521X186M050A(1)E050	90	10	50	2200	3	125
50	18	X/7343-43	T521X186M050A(1)E035	90	10	35	2700	3	125
50	22	D/7343-31	T521D226M050A(1)E090	110	10	90	1600	3	125
50	22	X/7343-43	T521X226M050A(1)E075	110	10	75	1815	3	125
50	22	X/7343-43	T521X226M050A(1)E050	110	10	50	2200	3	125
50	33	X/7343-43	T521X336M050A(1)E075	165	10	75	1815	3	125
50	33	X/7343-43	T521X336M050A(1)E050	165	10	50	2200	3	125
63	0.68	B/3528-21	T521B684M063A(1)E200	4.3	8	200	800	3	105
63	1	B/3528-21	T521B105M063A(1)E200	6.3	8	200	800	3	105
63	1.5	B/3528-21	T521B155M063A(1)E200	9.5	8	200	800	3	105
63	4.7	C/6032-28	T521C475M063A(1)E200	29.6	6	200	900	3	105
63	4.7	D/7343-31	T521D475M063A(1)E300	29.61	10	300	900	3	125
63	4.7	D/7343-31	T521D475M063A(1)E075	29.6	10	75	1700	3	125
63	6.8	X/7343-43	T521D685M063A(1)E075	42.8	10	75	1700	3	125
63	10	X/7343-43	T521X106M063A(1)E050	63	10	50	2200	3	125
63	15	X/7343-43	T521X156M063A(1)E035	94.5	10	35	2600	3	125
63	15	X/7343-43	T521X156M063A(1)E150	94.5	10	150	1300	3	125
63	22	X/7343-43	T521X226M063A(1)E075	138.6	10	75	1815	3	125
75	4.7	D/7343-31	T521D475M075A(1)E075	35.3	10	75	1700	3	125
75	10	X/7343-43	T521X106M075A(1)E050	75	10	50	2200	3	125
75	15	X/7343-43	T521X156M075A(1)E035	112.5	10	35	2600	3	125
VDC at 105°C	µF	KEMET/EIA	(See below for part options)	µA at 25°C Maximum/ 5 Minutes	% at 25°C 120 Hz Maximum	mΩ at 25°C 100 kHz Maximum	mA at +45°C 100 kHz	Reflow Temp ≤ 260°C	°C
Rated Voltage	Rated Capacitance	Case Code/ Case Size	KEMET Part Number	DC Leakage	DF	ESR	Maximum Allowable Ripple Current	MSL	Maximum Operating Temp

(1) To complete KEMET part number, insert T = 100% Matte Tin (Sn) Plated, H = Standard Solder coated (SnPb 5% Pb minimum), N = Non-Magnetic 100% Tin (Sn), M = Non-Magnetic (SnPb). Refer to Ordering Information for additional detail.

(2) To complete KEMET part number, insert M for ± 20% or K for ± 10%. Designates Capacitance tolerance.

Higher voltage ratings and tighter ESR may be substituted within the same size at KEMET's option. Voltage substitutions will be marked with the higher voltage rating. Substitutions can include better than series.

Part numbers marked in blue font are not recommended for new designs. Please use the T521 series instead.

Part numbers marked in orange font are not recommended for new designs. Please contact your KEMET representative for a replacement part.

^ Denotes the large reel (13") is not available.

Refer to Ordering Information for additional detail.

Derating Guidelines



Recommended Application Voltage

KOCAP's are solid state capacitors that demonstrate no wearout mechanism when operated within their recommended guidelines. While the KOCAP can be operated at full rated voltage, most circuit designers seek a minimum level of assurance in long term reliability which should be demonstrated with data. A voltage derating can provide the desired level of demonstrated reliability based on industry accepted acceleration models. Since most applications do require long term reliability, KEMET recommends that designers consider a voltage derating, according to the graphic above, for the maximum steady state voltage.

Voltage Rating	Maximum Recommended Steady State Voltage	
	-55°C to 105°C	105°C to 125°C
75 V ≤ V _R	90% of V _R	60% of V _R

V_R = Rated Voltage

Ripple Current/Ripple Voltage

Permissible AC ripple voltage and current are related to equivalent series resistance (ESR) and the power dissipation capabilities of the device. Permissible AC ripple voltage which may be applied is limited by two criteria:

- The positive peak AC voltage plus the DC bias voltage, if any, must not exceed the DC voltage rating of the capacitor.
- The negative peak AC voltage, in combination with bias voltage, if any, must not exceed the allowable limits specified for reverse voltage.

The maximum power dissipation must be reduced with increasing environmental operating temperatures. Refer to the table below for temperature compensation requirements.

Temperature Compensation Multipliers for Maximum Ripple Current		
T ≤ 45°C	45°C < T ≤ 85°C	85°C < T ≤ 125°C
1.00	0.70	0.25

T = Environmental Temperature

Surge Voltage

Surge voltage is the maximum voltage (peak value) which may be applied to the capacitor. The surge voltage must not be applied for periodic charging and discharging in course of normal operation and cannot be part of the application voltage. Surge voltage capability is demonstrated by application of 1,000 cycles at operating temperature. The parts are charged through a 33 Ohm resistor for 30 seconds and then discharged through a 33 Ohm resistor for each cycle.

Rated Voltage (V)	Surge Voltage (V)	Derated Voltage (V)	Derated Surge Voltage (V)
-55°C to 105°C		Up to 125°C	
2.5	3.3	1.7	2.2
6.3	8.2	4.2	5.5
10	13.0	6.7	8.7
16	20.8	10.7	13.9
20	26.0	13.4	17.4
25	32.5	16.8	21.8
35	45.5	23.5	30.5
50	65.0	33.5	43.6

Reverse Voltage

Polymer electrolytic capacitors are polar devices and may be permanently damaged or destroyed if connected in the wrong polarity. These devices will withstand a small degree of transient voltage reversal for short periods as shown in the below table.

Temperature	Permissible Transient Reverse Voltage
25°C	15% of Rated Voltage
55°C	10% of Rated Voltage
85°C	5% of Rated Voltage
105°C	3% of Rated Voltage
125°C*	1% of Rated Voltage

*For series rated to 125°C

Table 2 – Land Dimensions/Courtyard

T520/T521/T523/T525/T530

KEMET	Metric Size Code	Density Level A: Maximum (Most) Land Protrusion (mm)					Density Level B: Median (Nominal) Land Protrusion (mm)					Density Level C: Minimum (Least) Land Protrusion (mm)				
		Case	EIA	W	L	S	V1	V2	W	L	S	V1	V2	W	L	S
A	3216-18	1.35	2.20	0.62	6.02	2.80	1.23	1.80	0.82	4.92	2.30	1.13	1.42	0.98	4.06	2.04
B	3528-21	2.35	2.21	0.92	6.32	4.00	2.23	1.80	1.12	5.22	3.50	2.13	1.42	1.28	4.36	3.24
C	6032-28	2.35	2.77	2.37	8.92	4.50	2.23	2.37	2.57	7.82	4.00	2.13	1.99	2.73	6.96	3.74
D	7343-31	2.55	2.77	3.67	10.22	5.60	2.43	2.37	3.87	9.12	5.10	2.33	1.99	4.03	8.26	4.84
H	7360-20	4.25	2.77	3.67	10.22	7.30	4.13	2.37	3.87	9.12	6.80	4.03	1.99	4.03	8.26	6.54
J	7360-15	4.60	3.07	3.07	10.22	7.30	4.48	2.67	3.27	9.12	6.80	4.38	2.29	3.43	8.26	6.54
L	6032-19	2.35	2.77	2.37	8.92	4.50	2.23	2.37	2.57	7.82	4.00	2.13	1.99	2.73	6.96	3.74
M	3528-15	2.35	2.20	0.92	6.32	4.00	2.23	1.80	1.12	5.22	3.50	2.13	1.42	1.28	4.36	3.24
Q	7343-12	2.55	2.77	3.67	10.22	5.60	2.43	2.37	3.87	9.12	5.10	2.33	1.99	4.03	8.26	4.84
T	3528-12	2.35	2.20	0.92	6.32	4.00	2.23	1.80	1.12	5.22	3.50	2.13	1.42	1.28	4.36	3.24
U	6032-15	2.35	2.77	2.37	8.92	4.50	2.23	2.37	2.57	7.82	4.00	2.13	1.99	2.73	6.96	3.74
V	7343-21	2.55	2.77	3.67	10.22	5.60	2.43	2.37	3.87	9.12	5.10	2.33	1.99	4.03	8.26	4.84
W	7343-15	2.55	2.77	3.67	10.22	5.60	2.43	2.37	3.87	9.12	5.10	2.33	1.99	4.03	8.26	4.84
X ¹	7343-43	2.55	2.77	3.67	10.22	5.60	2.43	2.37	3.87	9.12	5.10	2.33	1.99	4.03	8.26	4.84
Y ¹	7343-40	2.55	2.77	3.67	10.22	5.60	2.43	2.37	3.87	9.12	5.10	2.33	1.99	4.03	8.26	4.84

Density Level A: For low-density product applications. Recommended for wave solder applications and provides a wider process window for reflow solder processes.

Density Level B: For products with a moderate level of component density. Provides a robust solder attachment condition for reflow solder processes.

Density Level C: For high component density product applications. Before adapting the minimum land pattern variations the user should perform qualification testing based on the conditions outlined in IPC standard 7351 (IPC-7351).

¹ Height of these chips may create problems in wave soldering.

² Land pattern geometry is too small for silkscreen outline.



Table 2 – Land Dimensions/Courtyard cont'd

T527

KEMET	Metric Size Code	Dimensions (mm) Minimum – Maximum			
		Case	EIA	G	Z
I	3216-10	1.00 – 1.65	3.25 – 3.80	1.1 – 1.30	0.8 – 1.40

(JEITA RC-2371 is recommended for reference)



T529

KEMET	Metric Size Code	Dimensions (mm) Minimum – Maximum			
		Case	EIA	G	Z
I	3216-10	1.00 – 1.65	3.25 – 3.80	1.1 – 1.30	0.8 – 1.40
P	2012-10	0.40 – 1.05	2.05 – 2.60	0.80 – 1.00	0.5 – 1.1

(JEITA RC-2371 is recommended for reference)



Soldering Process

The KEMET families of surface mount capacitors are compatible with wave (single or dual), convection, IR, or vapor phase reflow techniques. Preheating of these components is recommended to avoid extreme thermal stress. KEMET's recommended profile conditions for convection and IR reflow reflect the profile conditions of the IPC/J-STD-020D standard for moisture sensitivity testing. The devices can safely withstand a maximum of three reflow passes at these conditions.

Please note that although the X/7343-43 case size can withstand wave soldering, the tall profile (4.3 mm maximum) dictates care in wave process development.

Hand soldering should be performed with care due to the difficulty in process control. If performed, care should be taken to avoid contact of the soldering iron to the molded case. The iron should be used to heat the solder pad, applying solder between the pad and the termination, until reflow occurs. Once reflow occurs, the iron should be removed immediately. "Wiping" the edges of a chip and heating the top surface is not recommended.

Profile Feature	SnPb Assembly	Pb-Free Assembly
Preheat/Soak		
Temperature Minimum (T_{smin})	100°C	150°C
Temperature Maximum (T_{smax})	150°C	200°C
Time (t_s) from T_{smin} to T_{smax}	60 – 120 seconds	60 – 120 seconds
Ramp-up Rate (T_L to T_P)	3°C/seconds maximum	3°C/seconds maximum
Liquidous Temperature (T_L)	183°C	217°C
Time Above Liquidous (t_L)	60 – 150 seconds	60 – 150 seconds
Peak Temperature (T_P)	220°C* 235°C**	250°C* 260°C**
Time within 5°C of Maximum Peak Temperature (t_p)	20 seconds maximum	30 seconds maximum
Ramp-down Rate (T_P to T_L)	6°C/seconds maximum	6°C/seconds maximum
Time 25°C to Peak Temperature	6 minutes maximum	8 minutes maximum

Note: All temperatures refer to the center of the package, measured on the package body surface that is facing up during assembly reflow.

* For Case Size height > 2.5 mm

** For Case Size height ≤ 2.5 mm



Storage

All KO-CAP Series are shipped in moisture barrier bags (MBBs) with desiccant and humidity indicator card (HIC). These parts are classified as MSL3 (Moisture Sensitivity Level 3) per IPC/JEDEC J-STD-020 and packaged per IPC/JEDEC J-STD-033. MSL3 specifies a floor time of 168H at 30°C maximum temperature and 60% relative humidity. Unused capacitors should be sealed in a MBB with fresh desiccant.

The calculated shelf life in a sealed bag would be 12 months from a bag seal date in a storage environment of < 40°C and humidity < 90% RH. It should be 24 months from a bag seal date in a storage environment of < 30°C and humidity < 70% RH.

If baking is required, refer to IPC/JEDEC J-STD-033 for bake procedure.

Construction

T520/T521/T525/T530



T523



Construction cont'd

T527



T529



Capacitor Marking

T520/T521/T523/T525/T530



Date Code*	
1 st digit = Last number of Year	4 = 2014 5 = 2015 6 = 2016 7 = 2017 8 = 2018
2 nd and 3 rd digit = Week of the Year	01 = 1 st week of the Year to 52 = 52 nd week of the Year

* 817 = 17th week of 2018

T520A/T527



Code	e	g	j	A
Rated Voltage	2.5 V	4 V	6 V	10 V

Code	A7	E7	J7	N7	S7
Capacitance	10	15	22	33	47

Code	W7	A8	E8	J8	N8
Capacitance	68	100	150	220	330

Date Code*												
	Jan	Feb	Mar	Apr	May	Jun	Jul	Aug	Sep	Oct	Nov	Dec
2015	a	b	c	d	e	f	g	h	j	k	l	m
2016	n	p	q	r	s	t	u	v	w	x	y	z
2017	A	B	C	D	E	F	G	H	J	K	L	M
2018	N	P	Q	R	S	T	U	V	W	X	Y	Z

Capacitor Marking cont'd

T520B/T520T



T529



Code	J	A
Rated Voltage	6 V	10 V

Code	j	s	a
Capacitance	22	47	100

Date Code*												
	Jan	Feb	Mar	Apr	May	Jun	Jul	Aug	Sep	Oct	Nov	Dec
2015	a	b	c	d	e	f	g	h	j	k	l	m
2016	n	p	q	r	s	t	u	v	w	x	y	z
2017	A	B	C	D	E	F	G	H	J	K	L	M
2018	N	P	Q	R	S	T	U	V	W	X	Y	Z

Tape & Reel Packaging Information

KEMET's molded chip capacitor families are packaged in 8 and 12 mm plastic tape on 7" and 13" reels in accordance with *EIA Standard 481: Embossed Carrier Taping of Surface Mount Components for Automatic Handling*. This packaging system is compatible with all tape-fed automatic pick-and-place systems.



Table 3 – Packaging Quantity

Case Code		Tape Width (mm)	7" Reel*	13" Reel*
KEMET	EIA			
S	3216-12	8	2,500	10,000
T	3528-12	8	3,000	10,000
M	3528-15	8	2,500	8,000
U	6032-15	12	1,000	5,000
L	6032-19	12	1,000	3,000
W	7343-15	12	1,000	3,000
Z	7343-17	12	1,000	3,000
V	7343-20	12	1,000	3,000
A	3216-18	8	2,000	-
B	3528-21	8	2,000	8,000
C	6032-28	12	500	3,000
D	7343-31	12	500	2,500
Q	7343-12	12	1,000	3,000
Y	7343-40	12	500	2,000
X	7343-43	12	500	2,000
E/T428P	7360-38	12	500	2,000
H	7360-20	12	1,000	2,500
O	7360-43	12	250	1,000

* No C-Spec required for 7" reel packaging. C-7280 required for 13" reel packaging.

Figure 1 – Embossed (Plastic) Carrier Tape Dimensions



Table 4 – Embossed (Plastic) Carrier Tape Dimensions

Metric will govern

Constant Dimensions – Millimeters (Inches)									
Tape Size	D ₀	D ₁ Minimum Note 1	E ₁	P ₀	P ₂	R Reference Note 2	S ₁ Minimum Note 3	T Maximum	T ₁ Maximum
8 mm	1.5 +0.10/-0.0 (0.059+0.004/-0.0)	1.0 (0.039)	1.75±0.10 (0.069±0.004)	4.0±0.10 (0.157±0.004)	2.0±0.05 (0.079±0.002)	25.0 (0.984)	0.600 (0.024)	0.600 (0.024)	0.100 (0.004)
12 mm		1.5 (0.059)				30 (1.181)			

Variable Dimensions – Millimeters (Inches)									
Tape Size	Pitch	B ₁ Maximum Note 4	E ₂ Minimum	F	P ₁	T ₂ Maximum	W Maximum	A ₀ , B ₀ & K ₀	
8 mm	Single (4 mm)	4.35 (0.171)	6.25 (0.246)	3.5±0.05 (0.138±0.002)	2.0±0.05 or 4.0±0.10 (0.079±0.002 or 0.157±0.004)	2.5 (0.098)	8.3 (0.327)	Note 5	
12 mm	Single (4 mm) & Double (8 mm)	8.2 (0.323)	10.25 (0.404)	5.5±0.05 (0.217±0.002)	2.0±0.05 (0.079±0.002) or 4.0±0.10 (0.157±0.004) or 8.0±0.10 (0.315±0.004)	4.6 (0.181)	12.3 (0.484)		

1. The embossment hole location shall be measured from the sprocket hole controlling the location of the embossment. Dimensions of embossment location and hole location shall be applied independent of each other.
2. The tape, with or without components, shall pass around R without damage (see Figure 4).
3. If S₁ < 1.0 mm, there may not be enough area for cover tape to be properly applied (see EIA Standard 481-D, paragraph 4.3, section b).
4. B₁ dimension is a reference dimension for tape feeder clearance only.
5. The cavity defined by A₀, B₀ and K₀ shall surround the component with sufficient clearance that:
 - (a) the component does not protrude above the top surface of the carrier tape.
 - (b) the component can be removed from the cavity in a vertical direction without mechanical restriction, after the top cover tape has been removed.
 - (c) rotation of the component is limited to 20° maximum for 8 and 12 mm tapes (see Figure 2).
 - (d) lateral movement of the component is restricted to 0.5 mm maximum for 8 mm and 12 mm wide tape (see Figure 3).
 - (e) see Addendum in EIA Standard 481-D for standards relating to more precise taping requirements.

Packaging Information Performance Notes

- 1. Cover Tape Break Force:** 1.0 Kg minimum.
- 2. Cover Tape Peel Strength:** The total peel strength of the cover tape from the carrier tape shall be:

Tape Width	Peel Strength
8 mm	0.1 to 1.0 Newton (10 to 100 gf)
12 mm	0.1 to 1.3 Newton (10 to 130 gf)

The direction of the pull shall be opposite the direction of the carrier tape travel. The pull angle of the carrier tape shall be 165° to 180° from the plane of the carrier tape. During peeling, the carrier and/or cover tape shall be pulled at a velocity of 300 ±10 mm/minute.

- 3. Labeling:** Bar code labeling (standard or custom) shall be on the side of the reel opposite the sprocket holes. Refer to EIA Standards 556 and 624.

Figure 2 – Maximum Component Rotation

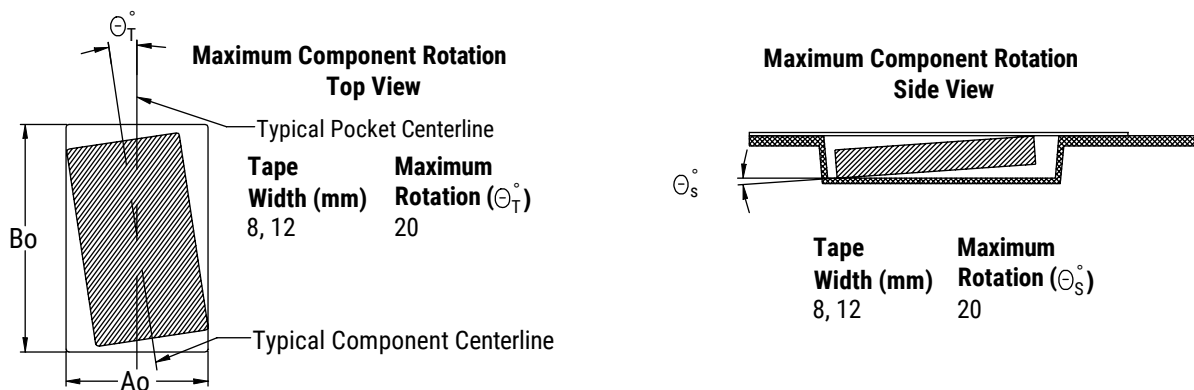

Figure 3 – Maximum Lateral Movement

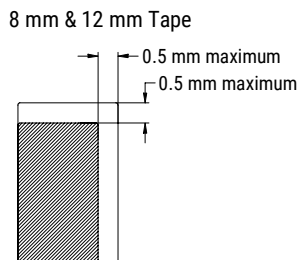

Figure 4 – Bending Radius

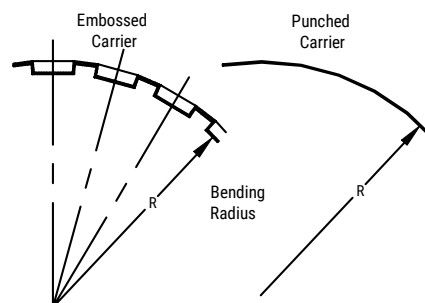

Figure 5 – Reel Dimensions



Note: Drive spokes optional; if used, dimensions B and D shall apply.

Table 5 – Reel Dimensions

Metric will govern

Constant Dimensions – Millimeters (Inches)				
Tape Size	A	B Minimum	C	D Minimum
8 mm	178±0.20 (7.008±0.008)	1.5 (0.059)	13.0+0.5/-0.2 (0.521+0.02/-0.008)	20.2 (0.795)
12 mm	330±0.20 (13.000±0.008)			
Variable Dimensions – Millimeters (Inches)				
Tape Size	N Minimum	W ₁	W ₂ Maximum	W ₃
8 mm	50 (1.969)	8.4+1.5/-0.0 (0.331+0.059/-0.0)	14.4 (0.567)	Shall accommodate tape width without interference
12 mm		12.4+2.0/-0.0 (0.488+0.078/-0.0)	18.4 (0.724)	

Figure 6 – Tape Leader & Trailer Dimensions



Figure 7 – Maximum Camber



KEMET Electronics Corporation Sales Offices

For a complete list of our global sales offices, please visit www.kemet.com/sales.

Disclaimer

All product specifications, statements, information and data (collectively, the "Information") in this datasheet are subject to change. The customer is responsible for checking and verifying the extent to which the Information contained in this publication is applicable to an order at the time the order is placed. All Information given herein is believed to be accurate and reliable, but it is presented without guarantee, warranty, or responsibility of any kind, expressed or implied.

Statements of suitability for certain applications are based on KEMET Electronics Corporation's ("KEMET") knowledge of typical operating conditions for such applications, but are not intended to constitute – and KEMET specifically disclaims – any warranty concerning suitability for a specific customer application or use. The Information is intended for use only by customers who have the requisite experience and capability to determine the correct products for their application. Any technical advice inferred from this Information or otherwise provided by KEMET with reference to the use of KEMET's products is given gratis, and KEMET assumes no obligation or liability for the advice given or results obtained.

Although KEMET designs and manufactures its products to the most stringent quality and safety standards, given the current state of the art, isolated component failures may still occur. Accordingly, customer applications which require a high degree of reliability or safety should employ suitable designs or other safeguards (such as installation of protective circuitry or redundancies) in order to ensure that the failure of an electrical component does not result in a risk of personal injury or property damage.

Although all product-related warnings, cautions and notes must be observed, the customer should not assume that all safety measures are indicated or that other measures may not be required.

KEMET is a registered trademark of KEMET Electronics Corporation.

Looking for pricing, stock, or lifecycle information?

Click below to explore more details on WIN SOURCE:

 [View T520B686M004AE035 on WIN SOURCE](#)

 [Kemet Information](#)

Optimize Your Supply Chain with WIN SOURCE Solutions

-  Global Sourcing Solution
-  Obsolete Management
-  Cost Control Management
-  Shortage Management
-  Alternative Solution
-  Excess Inventory Management