



Is Now Part of



ON Semiconductor®

To learn more about ON Semiconductor, please visit our website at
www.onsemi.com

Please note: As part of the Fairchild Semiconductor integration, some of the Fairchild orderable part numbers will need to change in order to meet ON Semiconductor's system requirements. Since the ON Semiconductor product management systems do not have the ability to manage part nomenclature that utilizes an underscore (_), the underscore (_) in the Fairchild part numbers will be changed to a dash (-). This document may contain device numbers with an underscore (_). Please check the ON Semiconductor website to verify the updated device numbers. The most current and up-to-date ordering information can be found at www.onsemi.com. Please email any questions regarding the system integration to Fairchild_questions@onsemi.com.

ON Semiconductor and the ON Semiconductor logo are trademarks of Semiconductor Components Industries, LLC dba ON Semiconductor or its subsidiaries in the United States and/or other countries. ON Semiconductor owns the rights to a number of patents, trademarks, copyrights, trade secrets, and other intellectual property. A listing of ON Semiconductor's product/patent coverage may be accessed at www.onsemi.com/site/pdf/Patent-Marking.pdf. ON Semiconductor reserves the right to make changes without further notice to any products herein. ON Semiconductor makes no warranty, representation or guarantee regarding the suitability of its products for any particular purpose, nor does ON Semiconductor assume any liability arising out of the application or use of any product or circuit, and specifically disclaims any and all liability, including without limitation special, consequential or incidental damages. Buyer is responsible for its products and applications using ON Semiconductor products, including compliance with all laws, regulations and safety requirements or standards, regardless of any support or applications information provided by ON Semiconductor. "Typical" parameters which may be provided in ON Semiconductor data sheets and/or specifications can and do vary in different applications and actual performance may vary over time. All operating parameters, including "Typicals" must be validated for each customer application by customer's technical experts. ON Semiconductor does not convey any license under its patent rights nor the rights of others. ON Semiconductor products are not designed, intended, or authorized for use as a critical component in life support systems or any FDA Class 3 medical devices or medical devices with a same or similar classification in a foreign jurisdiction or any devices intended for implantation in the human body. Should Buyer purchase or use ON Semiconductor products for any such unintended or unauthorized application, Buyer shall indemnify and hold ON Semiconductor and its officers, employees, subsidiaries, affiliates, and distributors harmless against all claims, costs, damages, and expenses, and reasonable attorney fees arising out of, directly or indirectly, any claim of personal injury or death associated with such unintended or unauthorized use, even if such claim alleges that ON Semiconductor was negligent regarding the design or manufacture of the part. ON Semiconductor is an Equal Opportunity/Affirmative Action Employer. This literature is subject to all applicable copyright laws and is not for resale in any manner.



74LVXC3245

8-Bit Dual Supply Configurable Voltage Interface Transceiver with 3-STATE Outputs

Features

- Bidirectional interface between 3V and 3V-to-5V buses
- Control inputs compatible with TTL level
- Outputs source/sink up to 24 mA
- Guaranteed simultaneous switching noise level and dynamic threshold performance
- Implements proprietary EMI reduction circuitry
- Flexible V_{CCB} operating range
- Allows B Port and V_{CCB} to float simultaneously when \overline{OE} is HIGH
- Functionally compatible with the 74 series 245

General Description

The LVXC3245 is a 24-pin dual-supply, 8-bit configurable voltage interface transceiver suited for PCMCIA and other real time configurable I/O applications. The V_{CCA} pin accepts a 3V supply level. The A Port is a dedicated 3V port. The V_{CCB} pin accepts a 3V-to-5V supply level. The B Port is configured to track the V_{CCB} supply level respectively. A 5V level on the V_{CC} pin will configure the I/O pins at a 5V level and a 3V V_{CC} will configure the I/O pins at a 3V level. The A Port should interface with a 3V host system and the B Port to the card slots. This device will allow the V_{CCB} voltage source pin and I/O pins on the B Port to float when \overline{OE} is HIGH. This feature is necessary to buffer data to and from a PCMCIA socket that permits PCMCIA cards to be inserted and removed during normal operation.

Ordering Code:

Order Number	Package Number	Package Description
74LVXC3245WM	M24B	224-Lead Small Outline Integrated Circuit (SOIC), JEDEC MS-013, 0.300" Wide
74LVXC3245QSC	MQA24	24-Lead Quarter Size Outline Package (QSOP), JEDEC MO-137, 0.150" Wide
74LVXC3245MTC	MTC24	24-Lead Thin Shrink Small Outline Package (TSSOP), JEDEC MO-153, 4.4mm Wide

Devices also available in Tape and Reel. Specify by appending suffix letter "X" to the ordering code.

Logic Symbol/s

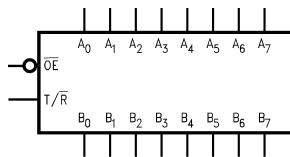

Connection Diagram/s

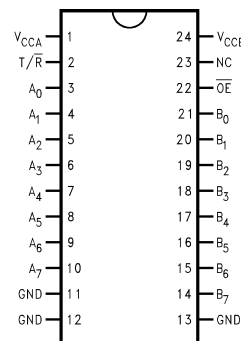

Pin Descriptions

Pin Names	Description
\overline{OE}	Output Enable Input
T/R	Transmit/Receive Input
A ₀ -A ₇	Side A Inputs or 3-STATE Outputs
B ₀ -B ₇	Side B Inputs or 3-STATE Outputs

Truth Table/s

Inputs		Outputs
OE	T/R	
L	L	Bus B Data to Bus A
L	H	Bus A Data to Bus B
H	X	HIGH-Z State

H = HIGH Voltage Level
 L = LOW Voltage Level
 X = Immaterial

Logic Diagram/s

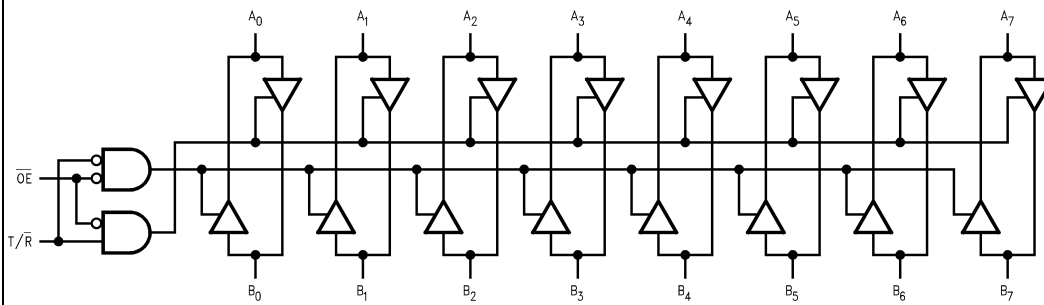

Absolute Maximum Ratings (Note 1)			Recommended Operating Conditions (Note 2)			
Supply Voltage (V_{CCA}, V_{CCB})	-0.5V to +7.0V		Supply Voltage	V_{CCA} 2.7V to 3.6V		
DC Input Voltage (V_I) @ $\overline{OE}, T/\overline{R}$	-0.5V to $V_{CCA} + 0.5V$			V_{CCB} 3.0V to 5.5V		
DC Input/Output Voltage ($V_{I/O}$)	-0.5V to $V_{CCB} + 0.5V$		Input Voltage (V_I) @ $\overline{OE}, T/\overline{R}$	0V to V_{CCA}		
@ A_n	-0.5V to $V_{CCA} + 0.5V$		Input Output Voltage ($V_{I/O}$)	0V to V_{CCA}		
@ B_n	-0.5V to $V_{CCB} + 0.5V$		@ A_n	0V to V_{CCA}		
DC Input Diode Current (I_{IK})	±20 mA		@ B_n	0V to V_{CCB}		
@ $\overline{OE}, T/\overline{R}$	±50 mA		Free Air Operating Temperature (T_A)	-40°C to +85°C		
DC Output Diode (I_{OK}) Current	±50 mA		Minimum Input Edge Rate ($\Delta t/\Delta V$)	8 ns/V		
DC Output Source or Sink Current (I_O)	±50 mA		V_{IN} from 30% to 70% of V_{CC}	V_{CC} @ 3.0V, 4.5V, 5.5V		
DC V_{CC} or Ground Current	±50 mA		Note 1: The "Absolute Maximum Ratings" are those values beyond which the safety of the device cannot be guaranteed. The device should not be operated at these limits. The parametric values defined in the Electrical Characteristics tables are not guaranteed at the absolute maximum ratings. The "Recommended Operating Conditions" table will define the conditions for actual device operation.			
per Output Pin (I_{CC} or I_{GND})	±200 mA		Note 2: The A Port unused pins (inputs or I/Os) must be held HIGH or LOW. They may not float.			
and Max Current	±200 mA					
Storage Temperature Range (T_{STG})	-65°C to +150°C					
DC Latch-Up Source or Sink Current	±300 mA					

DC Electrical Characteristics

Symbol	Parameter	V_{CCA} (V)	V_{CCB} (V)	$T_A = 25^\circ\text{C}$		$T_A = -40^\circ\text{C to } +85^\circ\text{C}$		Units	Conditions
				Typ	Guaranteed Limits	Typ	Guaranteed Limits		
V_{IHA}	Minimum HIGH Level Input Voltage	A_n , \overline{OE} , T/\overline{R}	2.7	3.0	2.0	2.0	2.0	V	$V_{OUT} \leq 0.1V$ or $\geq V_{CC} - 0.1V$
			3.0	3.6	2.0	2.0	2.0		
			3.6	5.5	2.0	2.0	2.0		
			B_n	2.7	3.0	2.0	2.0		
3.0	3.6	2.0		2.0	2.0				
3.6	5.5	3.85		3.85	3.85				
V_{ILA}	Maximum LOW Level Input Voltage	A_n , \overline{OE} , T/\overline{R}	2.7	3.0	0.8	0.8	0.8	V	$V_{OUT} \leq 0.1V$ or $\geq V_{CC} - 0.1V$
			3.0	3.6	0.8	0.8	0.8		
			3.6	5.5	0.8	0.8	0.8		
			B_n	2.7	3.0	0.8	0.8		
3.0	3.6	0.8		0.8	0.8				
3.6	5.5	1.65		1.65	1.65				
V_{OHA}	Minimum HIGH Level Output Voltage	3.0	3.0	3.0	2.99	2.9	2.9	V	$I_{OUT} = -100 \mu A$ $I_{OH} = -12 \text{ mA}$ $I_{OH} = -24 \text{ mA}$ $I_{OH} = -12 \text{ mA}$ $I_{OH} = -24 \text{ mA}$
			3.0	3.0	2.85	2.56	2.46		
			3.0	3.0	2.65	2.35	2.25		
			2.7	3.0	2.5	2.3	2.2		
			2.7	4.5	2.3	2.1	2.0		
V_{OHB}		3.0	3.0	3.0	2.99	2.9	2.9	V	$I_{OUT} = -100 \mu A$ $I_{OH} = -12 \text{ mA}$ $I_{OH} = -24 \text{ mA}$ $I_{OH} = -24 \text{ mA}$
			3.0	3.0	2.85	2.56	2.46		
			3.0	3.0	2.65	2.35	2.25		
			3.0	4.5	4.25	3.86	3.76		
V_{OLA}	Maximum LOW Level Output Voltage	3.0	3.0	3.0	0.002	0.1	0.1	V	$I_{OUT} = 100 \mu A$ $I_{OL} = 24 \text{ mA}$ $I_{OL} = 12 \text{ mA}$ $I_{OL} = 24 \text{ mA}$
			3.0	3.0	0.21	0.36	0.44		
			2.7	3.0	0.11	0.36	0.44		
			2.7	4.5	0.22	0.42	0.5		
V_{OLB}		3.0	3.0	3.0	0.002	0.1	0.1	V	$I_{OUT} = 100 \mu A$ $I_{OL} = 24 \text{ mA}$ $I_{OL} = 24 \text{ mA}$
			3.0	3.0	0.21	0.36	0.44		
			3.0	4.5	0.18	0.36	0.44		
I_{IN}	Maximum Input Leakage Current @ $\overline{OE}, T/\overline{R}$	3.6	3.6		±0.1	±1.0	μA	$V_I = V_{CCA}, \text{GND}$	
		3.6	5.5		±0.1	±1.0			

DC Electrical Characteristics (Continued)

Symbol	Parameter	V _{CCA} (V)	V _{CCB} (V)	T _A = 25°C		T _A = -40°C to +85°C		Units	Conditions
				Typ	Guaranteed Limits				
I _{OZA}	Maximum 3-STATE Output Leakage @ A _n	3.6	3.6		±0.5	±5.0	μA	V _I = V _{IL} , V _{IH} , OE = V _{CCA} V _O = V _{CCA} , GND	
		3.6	5.5		±0.5	±5.0			
I _{OZB}	Maximum 3-STATE Output Leakage @ B _n	3.6	3.6		±0.5	±5.0	μA	V _I = V _{IL} , V _{IH} , OE = V _{CCA} V _O = V _{CCB} , GND	
		3.6	5.5		±0.5	±5.0			
ΔI _{CC}	Maximum I _{CC} /Input	B _n	3.6	5.5	1.0	1.35	mA	V _I = V _{CCB} - 2.1V V _I = V _{CC} - 0.6V	
		All Inputs	3.6	3.6		0.35			0.5
I _{CCA1}	Quiescent V _{CCA} Supply Current as B Port Floats	3.6	Open		5	50	μA	A _n = V _{CCA} or GND B _n = Open, OE = V _{CCA} , T/R = V _{CCA} , V _{CCB} = Open	
I _{CCA2}	Quiescent V _{CCA} Supply Current	3.6	3.6		5	50	μA	A _n = V _{CCA} or GND, B _n = V _{CCB} or GND, OE = GND, T/R = GND	
		3.6	5.5		5	50			
I _{CCB}	Quiescent V _{CCB} Supply Current	3.6	3.6		5	50	μA	A _n = V _{CCA} or GND, B _n = V _{CCB} or GND, OE = GND, T/R = V _{CCA}	
		3.6	5.5		8	80			
V _{OLPA}	Quiet Output Maximum Dynamic	3.3	3.3		0.8		V	(Note 3)(Note 4)	
V _{OLPB}	V _{OL}	3.3	3.3		0.8		V	(Note 3)(Note 4)	
		3.3	5.0		1.5				
V _{OLVA}	Quiet Output Minimum Dynamic	3.3	3.3		-0.8		V	(Note 3)(Note 4)	
		3.3	5.0		-0.8				
V _{OLVB}	V _{OL}	3.3	3.3		-0.8		V	(Note 3)(Note 4)	
		3.3	5.0		-1.2				
V _{IHDA}	Minimum HIGH Level Dynamic	3.3	3.3		2.0		V	(Note 3)(Note 5)	
		3.3	5.0		2.0				
V _{IHDB}	Input Voltage	3.3	3.3		2.0		V	(Note 3)(Note 5)	
		3.3	5.0		3.5				
V _{ILDA}	Maximum LOW Level Dynamic	3.3	3.3		0.8		V	(Note 3)(Note 5)	
		3.3	5.0		0.8				
V _{ILDB}	Input Voltage	3.3	3.3		0.8		V	(Note 3)(Note 5)	
		3.3	5.0		1.5				

Note 3: Worst case package.

Note 4: Max number of outputs defined as (n). Data inputs are driven 0V to V_{CC} level; one output at GND.

Note 5: Max number of Data Inputs (n) switching. (n-1) inputs switching 0V to V_{CC} level. Input-under-test switching: V_{CC} level to threshold (V_{IH}), 0V to threshold (V_{IL}), f = 1 MHz.

AC Electrical Characteristics												
Symbol	Parameter	T _A = +25°C C _L = 50 pF V _{CCA} = 2.7V–3.6V V _{CCB} = 4.5V–5.5V			T _A = –40°C to +85°C C _L = 50 pF V _{CCA} = 2.7V–3.6V V _{CCB} = 4.5V–5.5V		T _A = +25°C C _L = 50 pF V _{CCA} = 2.7V–3.6V V _{CCB} = 3.0V–3.6V			T _A = –40°C to +85°C C _L = 50 pF V _{CCA} = 2.7V–3.6V V _{CCB} = 3.0V–3.6V		Units
		Min	Typ (Note 6)	Max	Min	Max	Min	Typ (Note 7)	Max	Min	Max	
t _{PHL}	Propagation Delay	1.0	4.8	8.0	1.0	8.5	1.0	5.5	8.5	1.0	9.0	ns
t _{PLH}	A to B	1.0	3.9	6.5	1.0	7.0	1.0	5.2	8.0	1.0	8.5	
t _{PHL}	Propagation Delay	1.0	3.8	6.5	1.0	7.0	1.0	4.4	7.0	1.0	7.5	ns
t _{PLH}	B to A	1.0	4.3	7.5	1.0	8.0	1.0	5.1	7.5	1.0	8.0	
t _{PZL}	Output Enable Time	1.0	4.7	8.0	1.0	8.5	1.0	6.0	9.0	1.0	9.5	ns
t _{PZH}	$\overline{\text{OE}}$ to B	1.0	4.8	8.5	1.0	9.0	1.0	6.1	9.5	1.0	10.0	
t _{PZL}	Output Enable Time	1.0	5.9	9.5	1.0	10.0	1.0	6.4	10.0	1.0	10.5	ns
t _{PZH}	$\overline{\text{OE}}$ to A	1.0	5.4	9.0	1.0	9.5	1.0	5.8	9.0	1.0	9.5	
t _{PHZ}	Output Disable Time	1.0	4.0	8.0	1.0	8.5	1.0	6.3	9.5	1.0	10.0	ns
t _{PLZ}	$\overline{\text{OE}}$ to B	1.0	3.8	7.5	1.0	8.0	1.0	4.5	8.0	1.0	8.5	
t _{PHZ}	Output Disable Time	1.0	4.6	9.5	1.0	10.0	1.0	5.2	9.5	1.0	10.0	ns
t _{PLZ}	$\overline{\text{OE}}$ to A	1.0	3.1	6.5	1.0	7.0	1.0	3.4	6.5	1.0	7.0	
t _{OSSL}	Output to Output											ns
t _{OSLH}	Skew (Note 8) Data to Output		1.0	1.5		1.5		1.0	1.5		1.5	

Note 6: Typical values at V_{CCA} = 3.3V, V_{CCB} = 5.0V @ 25°C.

Note 7: Typical values at V_{CCA} = 3.3V, V_{CCB} = 3.3V @ 25°C.

Note 8: Skew is defined as the absolute value of the difference between the actual propagation delay for any two separate outputs of the same device. The specification applies to any outputs switching in the same direction, either HIGH-to-LOW (t_{OSSL}) or LOW-to-HIGH (t_{OSLH}). Parameter guaranteed by design.

Capacitance

Symbol	Parameter	Typ	Units	Conditions	
C _{IN}	Input Capacitance	4.5	pF	V _{CC} = Open	
C _{I/O}	Input/Output Capacitance	10	pF	V _{CCA} = 3.3V V _{CCB} = 5.0V	
C _{PD}	Power Dissipation Capacitance (Note 9)	A→B	50	pF	V _{CCB} = 5.0V
		B→A	40	pF	V _{CCA} = 3.3V

Note 9: C_{PD} is measured at 10 MHz.

Physical Dimensions inches (millimeters) unless otherwise noted

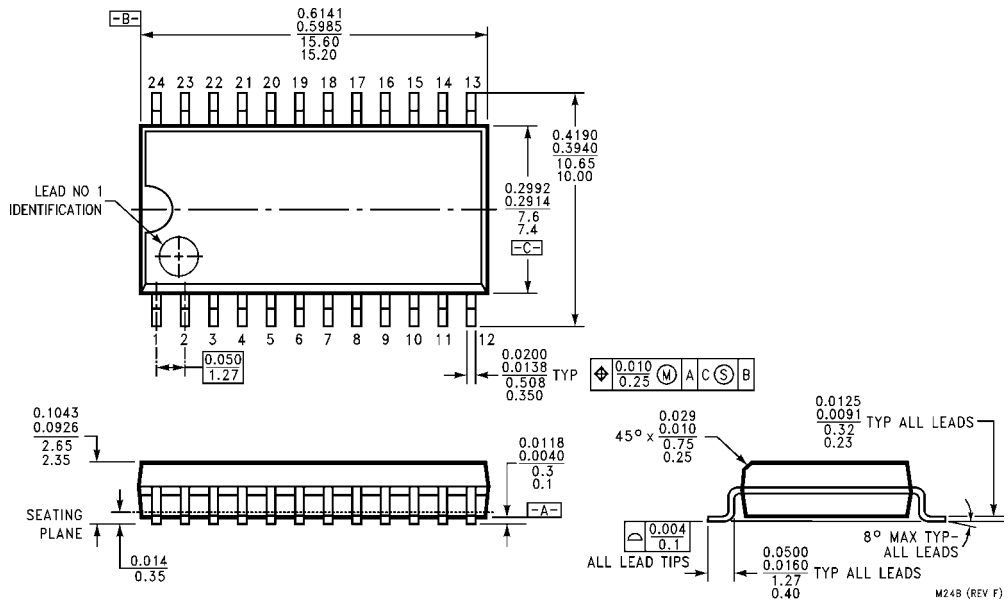

**24-Lead Small Outline Integrated Circuit (SOIC), JEDEC MS-013, 0.300" Wide
Package Number M248**

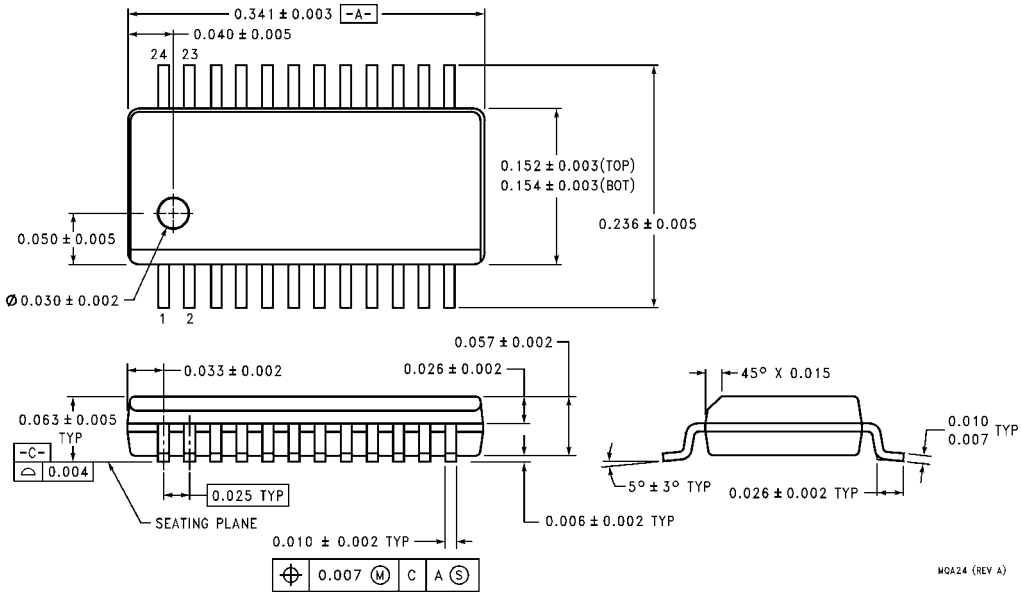

**24-Lead Quarter Size Outline Package (QSOP), JEDEC MO-137, 0.150" Wide
Package Number MQA24**

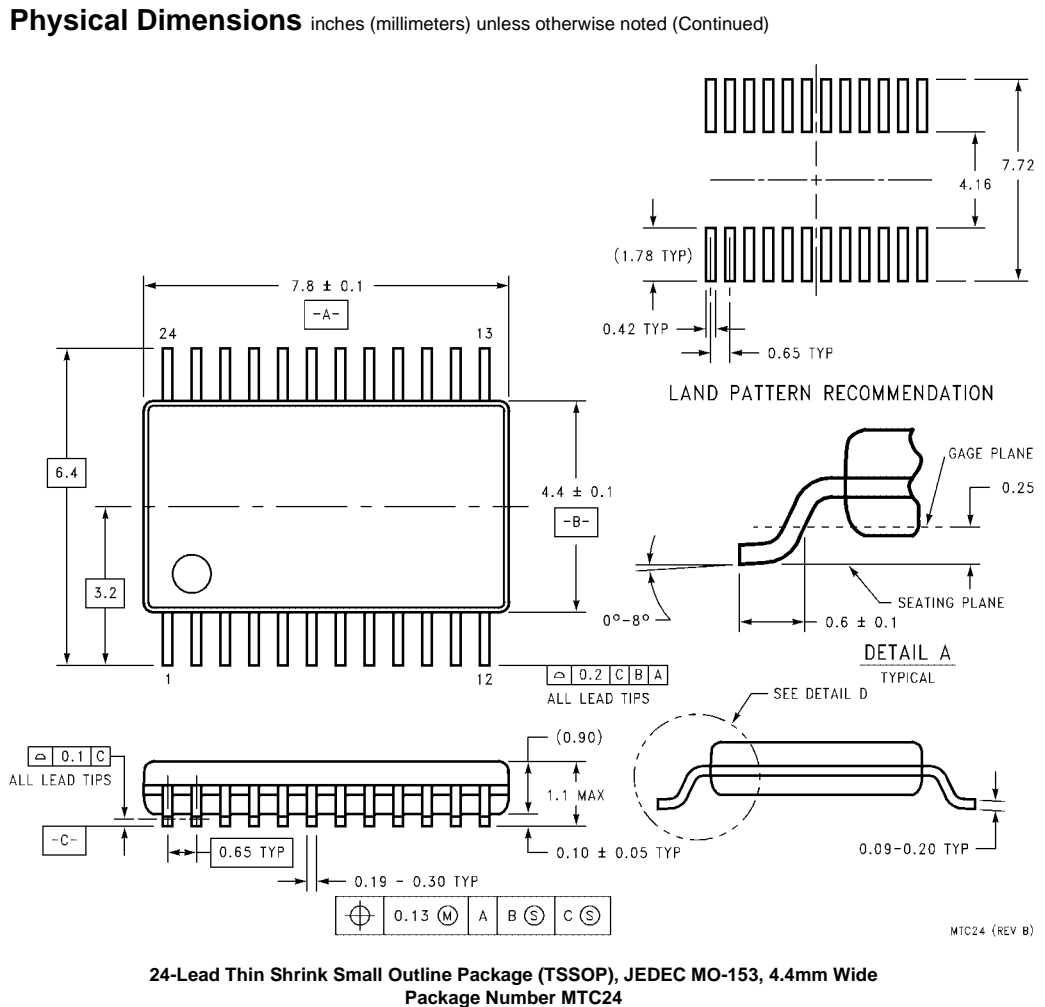

Fairchild does not assume any responsibility for use of any circuitry described, no circuit patent licenses are implied and Fairchild reserves the right at any time without notice to change said circuitry and specifications.

LIFE SUPPORT POLICY

FAIRCHILD'S PRODUCTS ARE NOT AUTHORIZED FOR USE AS CRITICAL COMPONENTS IN LIFE SUPPORT DEVICES OR SYSTEMS WITHOUT THE EXPRESS WRITTEN APPROVAL OF THE PRESIDENT OF FAIRCHILD SEMICONDUCTOR CORPORATION. As used herein:

1. Life support devices or systems are devices or systems which, (a) are intended for surgical implant into the body, or (b) support or sustain life, and (c) whose failure to perform when properly used in accordance with instructions for use provided in the labeling, can be reasonably expected to result in a significant injury to the user.
2. A critical component in any component of a life support device or system whose failure to perform can be reasonably expected to cause the failure of the life support device or system, or to affect its safety or effectiveness.

www.fairchildsemi.com



TRADEMARKS

The following includes registered and unregistered trademarks and service marks, owned by Fairchild Semiconductor and/or its global subsidiaries, and is not intended to be an exhaustive list of all such trademarks.

- | | | | |
|--------------------------|------------------------|---------------------------------------|--|
| Build it Now™ | FRFET® | Programmable Active Droop™ | <p>TinyBoost™
 TinyBuck™
 TinyLogic®
 TINYOPTO™
 TinyPower™
 TinyPWM™
 TinyWire™
 TriFault Detect™
 µSerDes™

 UHC®
 Ultra FRFET™
 UniFET™
 VCX™
 VisualMax™
 XS™</p> |
| CorePLUS™ | Global Power Resource™ | OFET® | |
| CorePOWER™ | Green FPST™ | Q5™ | |
| CROSSVOLT™ | Green FPST™ e-Series™ | Quiet Series™ | |
| CTL™ | GTO™ | RapidConfigure™ | |
| Current Transfer Logic™ | IntelliMAX™ | ™ | |
| EcoSPARK® | ISOPLANAR™ | Saving our world, 1mW/W/kW at a time™ | |
| EfficientMax™ | MegaBuck™ | SmartMax™ | |
| EZSWITCH™* | MICROCOUPLER™ | SMART START™ | |
| ™ | MicroFET™ | SPM® | |
| ™ | MicroPak™ | STEALTH™ | |
| Fairchild® | MillerDrive™ | SuperFET™ | |
| Fairchild Semiconductor® | MotionMax™ | SuperSOT™-3 | |
| FACT Quiet Series™ | Motion-SPM™ | SuperSOT™-6 | |
| FACT™ | OPTOLOGIC® | SuperSOT™-8 | |
| FAST® | OPTOPLANAR® | SupreMOS™ | |
| FastvCore™ | | SyncFET™ | |
| FlashWriter®* | PDP SPM™ | ™ | |
| FPS™ | Power-SPM™ | The Power Franchise® | |
| F-PFS™ | PowerTrench® | | |
| | PowerXS™ | | |

* EZSWITCH™ and FlashWriter® are trademarks of System General Corporation, used under license by Fairchild Semiconductor.

DISCLAIMER

FAIRCHILD SEMICONDUCTOR RESERVES THE RIGHT TO MAKE CHANGES WITHOUT FURTHER NOTICE TO ANY PRODUCTS HEREIN TO IMPROVE RELIABILITY, FUNCTION, OR DESIGN. FAIRCHILD DOES NOT ASSUME ANY LIABILITY ARISING OUT OF THE APPLICATION OR USE OF ANY PRODUCT OR CIRCUIT DESCRIBED HEREIN; NEITHER DOES IT CONVEY ANY LICENSE UNDER ITS PATENT RIGHTS, NOR THE RIGHTS OF OTHERS. THESE SPECIFICATIONS DO NOT EXPAND THE TERMS OF FAIRCHILD'S WORLDWIDE TERMS AND CONDITIONS, SPECIFICALLY THE WARRANTY THEREIN, WHICH COVERS THESE PRODUCTS.

LIFE SUPPORT POLICY

FAIRCHILD'S PRODUCTS ARE NOT AUTHORIZED FOR USE AS CRITICAL COMPONENTS IN LIFE SUPPORT DEVICES OR SYSTEMS WITHOUT THE EXPRESS WRITTEN APPROVAL OF FAIRCHILD SEMICONDUCTOR CORPORATION.

As used herein:

1. Life support devices or systems are devices or systems which, (a) are intended for surgical implant into the body or (b) support or sustain life, and (c) whose failure to perform when properly used in accordance with instructions for use provided in the labeling, can be reasonably expected to result in a significant injury of the user.
2. A critical component in any component of a life support, device, or system whose failure to perform can be reasonably expected to cause the failure of the life support device or system, or to affect its safety or effectiveness.

ANTI-COUNTERFEITING POLICY

Fairchild Semiconductor Corporation's Anti-Counterfeiting Policy. Fairchild's Anti-Counterfeiting Policy is also stated on our external website, www.fairchildsemi.com, under Sales Support.

Counterfeiting of semiconductor parts is a growing problem in the industry. All manufacturers of semiconductor products are experiencing counterfeiting of their parts. Customers who inadvertently purchase counterfeit parts experience many problems such as loss of brand reputation, substandard performance, failed applications, and increased cost of production and manufacturing delays. Fairchild is taking strong measures to protect ourselves and our customers from the proliferation of counterfeit parts. Fairchild strongly encourages customers to purchase Fairchild parts either directly from Fairchild or from Authorized Fairchild Distributors who are listed by country on our web page cited above. Products customers buy either from Fairchild directly or from Authorized Fairchild Distributors are genuine parts, have full traceability, meet Fairchild's quality standards for handling and storage and provide access to Fairchild's full range of up-to-date technical and product information. Fairchild and our Authorized Distributors will stand behind all warranties and will appropriately address any warranty issues that may arise. Fairchild will not provide any warranty coverage or other assistance for parts bought from Unauthorized Sources. Fairchild is committed to combat this global problem and encourage our customers to do their part in stopping this practice by buying direct or from authorized distributors.

PRODUCT STATUS DEFINITIONS

Definition of Terms

Datasheet Identification	Product Status	Definition
Advance Information	Formative / In Design	Datasheet contains the design specifications for product development. Specifications may change in any manner without notice.
Preliminary	First Production	Datasheet contains preliminary data; supplementary data will be published at a later date. Fairchild Semiconductor reserves the right to make changes at any time without notice to improve design.
No Identification Needed	Full Production	Datasheet contains final specifications. Fairchild Semiconductor reserves the right to make changes at any time without notice to improve the design.
Obsolete	Not In Production	Datasheet contains specifications on a product that is discontinued by Fairchild Semiconductor. The datasheet is for reference information only.

Rev. 138

ON Semiconductor and  are trademarks of Semiconductor Components Industries, LLC dba ON Semiconductor or its subsidiaries in the United States and/or other countries. ON Semiconductor owns the rights to a number of patents, trademarks, copyrights, trade secrets, and other intellectual property. A listing of ON Semiconductor's product/patent coverage may be accessed at www.onsemi.com/site/pdf/Patent-Marking.pdf. ON Semiconductor reserves the right to make changes without further notice to any products herein. ON Semiconductor makes no warranty, representation or guarantee regarding the suitability of its products for any particular purpose, nor does ON Semiconductor assume any liability arising out of the application or use of any product or circuit, and specifically disclaims any and all liability, including without limitation special, consequential or incidental damages. Buyer is responsible for its products and applications using ON Semiconductor products, including compliance with all laws, regulations and safety requirements or standards, regardless of any support or applications information provided by ON Semiconductor. "Typical" parameters which may be provided in ON Semiconductor data sheets and/or specifications can and do vary in different applications and actual performance may vary over time. All operating parameters, including "Typicals" must be validated for each customer application by customer's technical experts. ON Semiconductor does not convey any license under its patent rights nor the rights of others. ON Semiconductor products are not designed, intended, or authorized for use as a critical component in life support systems or any FDA Class 3 medical devices or medical devices with a same or similar classification in a foreign jurisdiction or any devices intended for implantation in the human body. Should Buyer purchase or use ON Semiconductor products for any such unintended or unauthorized application, Buyer shall indemnify and hold ON Semiconductor and its officers, employees, subsidiaries, affiliates, and distributors harmless against all claims, costs, damages, and expenses, and reasonable attorney fees arising out of, directly or indirectly, any claim of personal injury or death associated with such unintended or unauthorized use, even if such claim alleges that ON Semiconductor was negligent regarding the design or manufacture of the part. ON Semiconductor is an Equal Opportunity/Affirmative Action Employer. This literature is subject to all applicable copyright laws and is not for resale in any manner.

PUBLICATION ORDERING INFORMATION

LITERATURE FULFILLMENT:



Literature Distribution Center for ON Semiconductor
19521 E. 32nd Pkwy, Aurora, Colorado 80011 USA
Phone: 303-675-2175 or 800-344-3860 Toll Free USA/Canada
Fax: 303-675-2176 or 800-344-3867 Toll Free USA/Canada
Email: orderlit@onsemi.com

N. American Technical Support: 800-282-9855 Toll Free
USA/Canada
Europe, Middle East and Africa Technical Support:
Phone: 421 33 790 2910
Japan Customer Focus Center
Phone: 81-3-5817-1050

ON Semiconductor Website: www.onsemi.com
Order Literature: <http://www.onsemi.com/orderlit>
For additional information, please contact your local
Sales Representative

Looking for pricing, stock, or lifecycle information?

Click below to explore more details on WIN SOURCE:

-  [View 74LVXC3245MTC on WIN SOURCE](#)
-  [Fairchild/ON Semiconductor Information](#)

Optimize Your Supply Chain with WIN SOURCE Solutions

-  Global Sourcing Solution
-  Obsolete Management
-  Cost Control Management
-  Shortage Management
-  Alternative Solution
-  Excess Inventory Management