



**THE DATASHEET OF
T1630-600W**



16A SNUBBERLESS™ TRIAC
MAIN FEATURES

Symbol	Value	Unit
$I_{T(RMS)}$	16	A
V_{DRM}/V_{RRM}	600 and 800	V
I_{GT}	20 to 30	mA

DESCRIPTION

Based on ST' Snubberless technology providing high commutation performances, the T1620-600W/800W & T1630-600W/800W are specially recommended for use on inductive loads, thanks to their high commutation performances, such as vacuum cleaners, heating regulation. They comply with UL standards (ref. E81734).

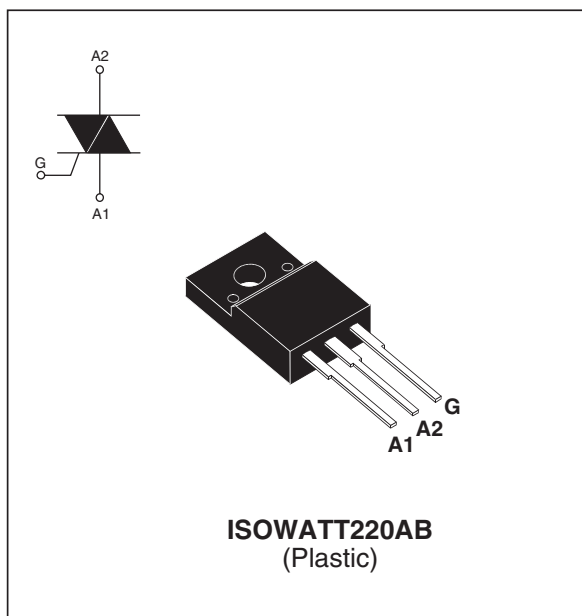
ABSOLUTE RATINGS (limiting values)

Symbol	Parameter		Value	Unit
$I_{T(RMS)}$	RMS on-state current (Full sine wave)		$T_c = 80^\circ\text{C}$	16 A
I_{TSM}	Non repetitive surge peak on-state current (Full cycle, T_j initial = 25°C)	F = 50Hz	t = 20ms	200 A
		F = 60Hz	t = 16.7ms	218 A
I^2t	I^2t Value for fusing	tp = 10 ms		220 A ² s
dl/dt	Critical rate of rise of on-state current $I_G = 2 \times I_{GT}$, tr ≤ 100ns	F = 120 Hz	$T_j = 125^\circ\text{C}$	50 A/μs
V_{DSM}/V_{RSM}	Non repetitive surge peak off-state voltage	tp = 10ms	$T_j = 25^\circ\text{C}$	$V_{DRM}/V_{RRM} + 100$ V
I_{GM}	Peak gate current	tp = 20μs	$T_j = 125^\circ\text{C}$	4 A
$P_{G(AV)}$	Average gate power dissipation		$T_j = 125^\circ\text{C}$	1 W
T_{stg} T_j	Storage junction temperature range Operating junction temperature range			- 40 to + 150 - 40 to + 125 °C

T820W / T830W

ELECTRICAL CHARACTERISTICS (T_j = 25°C, unless otherwise specified)

Symbol	Test Conditions	Quadrant		T1620	T1630	Unit
I _{GT} ⁽¹⁾	V _D =12V R _L =30Ω	I-II-III	MAX.	20	30	mA
V _{GT}		I-II-III	MAX.	1.3		V
V _{GD}	V _D =V _{DRM} R _L =3.3kΩ T _j = 125°C	I-II-III	MIN.	0.2		V
I _H ⁽²⁾	I _T = 250mA		MAX.	35	50	mA
I _L	I _G = 1.2I _{GT}	I - III	MAX.	70	80	mA
		II	MAX.	80	100	mA
dV/dt ⁽²⁾	V _D =67% V _{DRM} Gate open T _j = 125°C		MIN.	300	500	V/μs
(dI/dt) _c ⁽²⁾	Without snubber T _j = 125°C		MIN.	8.5	11	A/ms

STATIC CHARACTERISTICS

Symbol	Test Conditions			Value	Unit	
V _{TM} ⁽²⁾	I _{TM} = 22.5 A	tp = 380μs	T _j = 25°C	MAX.	1.4	V
V _{TO} ⁽²⁾	Threshold voltage		T _j = 125°C	MAX.	0.85	V
R _d ⁽²⁾	Dynamic resistance		T _j = 125°C	MAX.	20	mΩ
I _{DRM} I _{RRM}	V _{DRM} = V _{RRM}		T _j = 25°C T _j = 125°C	MAX	5 1	μA mA

Note 1: Minimum IGT is guaranteed at 5% of IGT max.

Note 2: For both polarities of A2 referenced to A1.

THERMAL RESISTANCES

Symbol	Parameter	Value	Unit
R _{th(j-a)}	Junction to ambient	60	°C/W
R _{th(j-c)}	Junction to case (AC)	3.1	°C/W

PRODUCT SELECTOR

Part Number	Voltage	Sensitivity	Type	Package
T1620-600W	600V	20 mA	Snubberless	ISOWATT220AB
T1620-800W	800V	20 mA	Snubberless	ISOWATT220AB
T1630-600W	600V	30 mA	Snubberless	ISOWATT220AB
T1630-800W	800V	30 mA	Snubberless	ISOWATT220AB

ORDERING INFORMATION

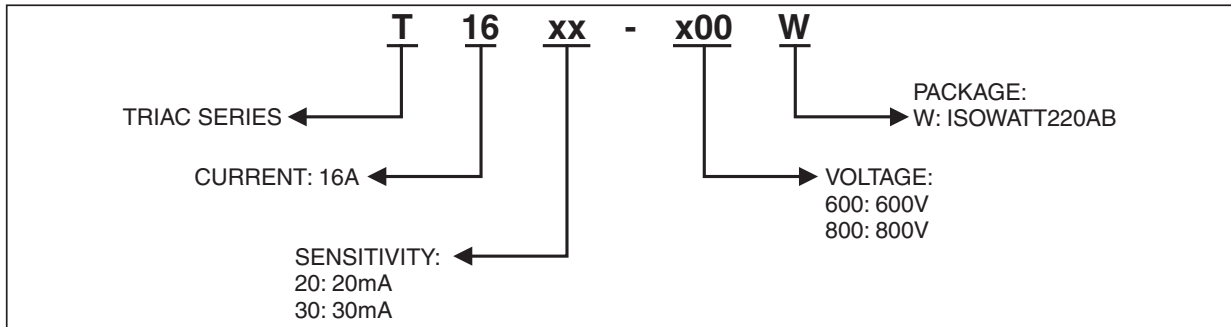

OTHER INFORMATION

Part Number	Marking	Weight	Base quantity	Packing mode
T1620-600W	T1620600W	2.3 g	50	Tube
T1620-800W	T1620800W	2.3 g	50	Tube
T1630-600W	T1630600W	2.3 g	50	Tube
T1630-800W	T1630800W	2.3 g	50	Tube

Fig. 1: Maximum power dissipation versus RMS on-state current.

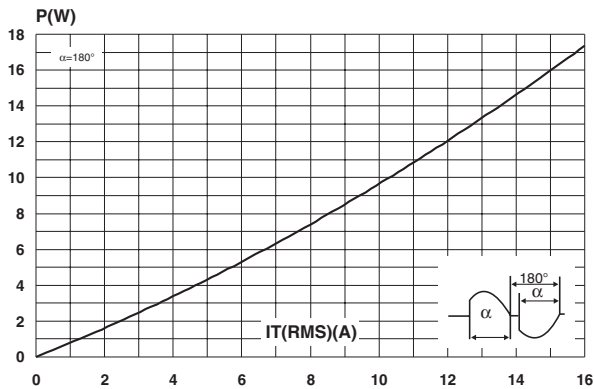

Fig. 3: Relative variation of thermal impedance versus pulse duration.

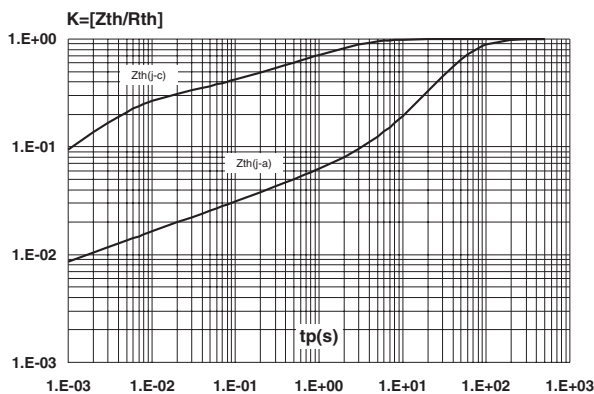

Fig. 2: RMS on-state current versus case temperature.

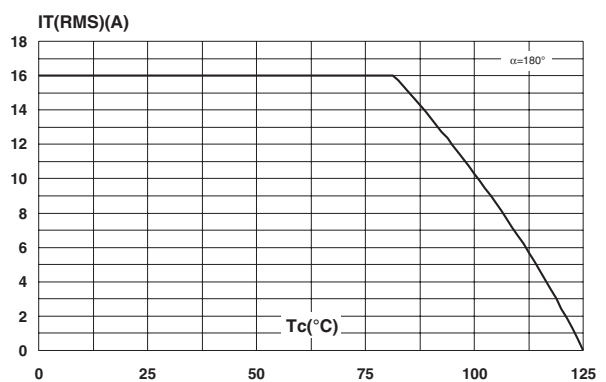

Fig. 4: On-state characteristics (maximum values).

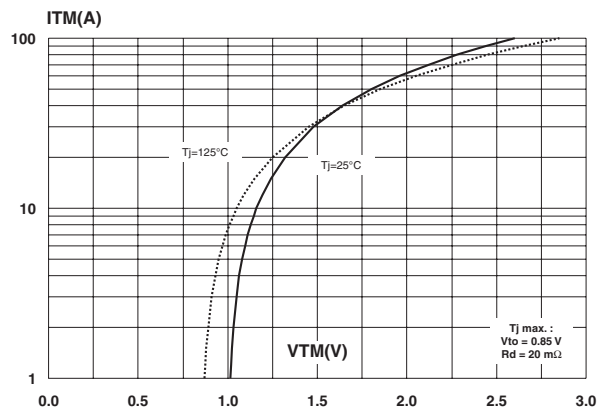

Fig. 5: Surge peak on-state current versus number of cycles.

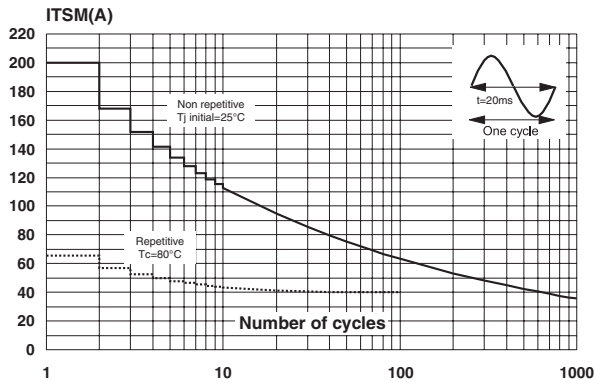

Fig. 6: Non repetitive surge peak on-state current for a sinusoidal pulse with width $t_p < 10\text{ms}$, and corresponding value of I^2t .

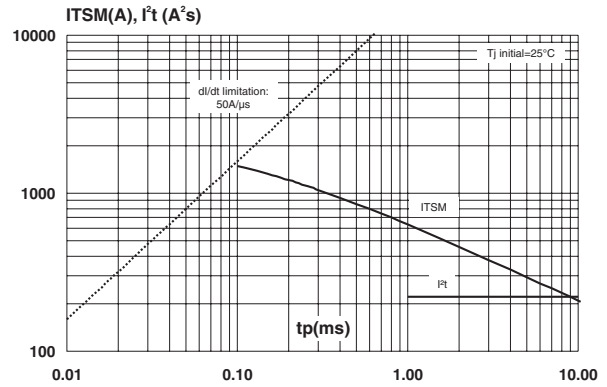

Fig. 7: Relative variation of gate trigger current, holding current and latching current versus junction temperature (typical values).

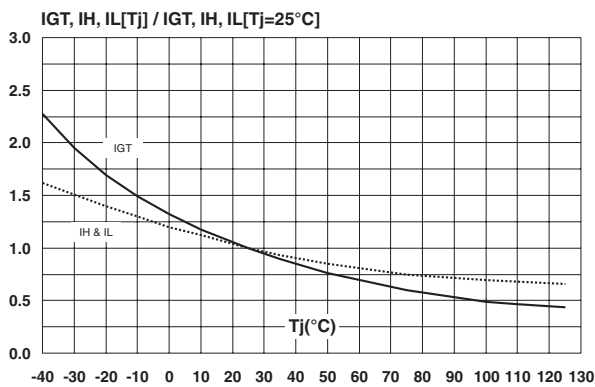

Fig. 8: Relative variation of critical rate of decrease of main current versus reapplied dV/dt (typical values).

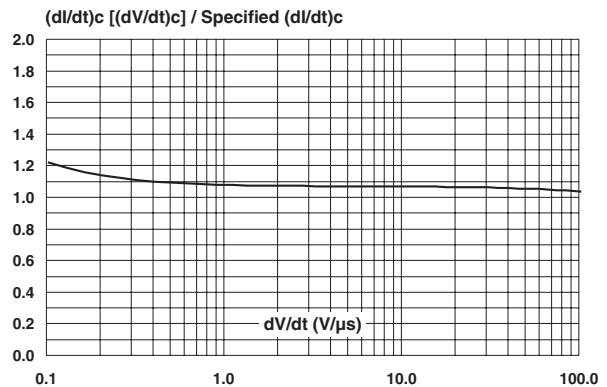
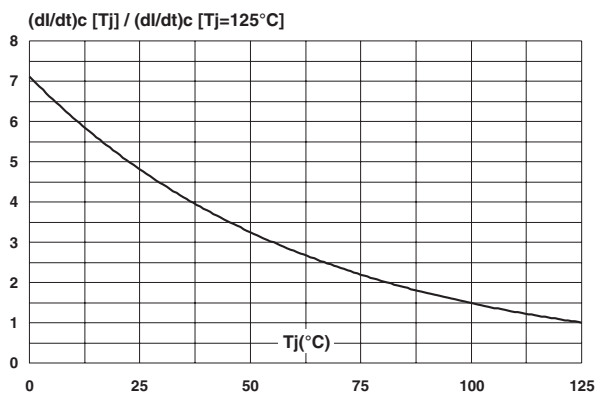
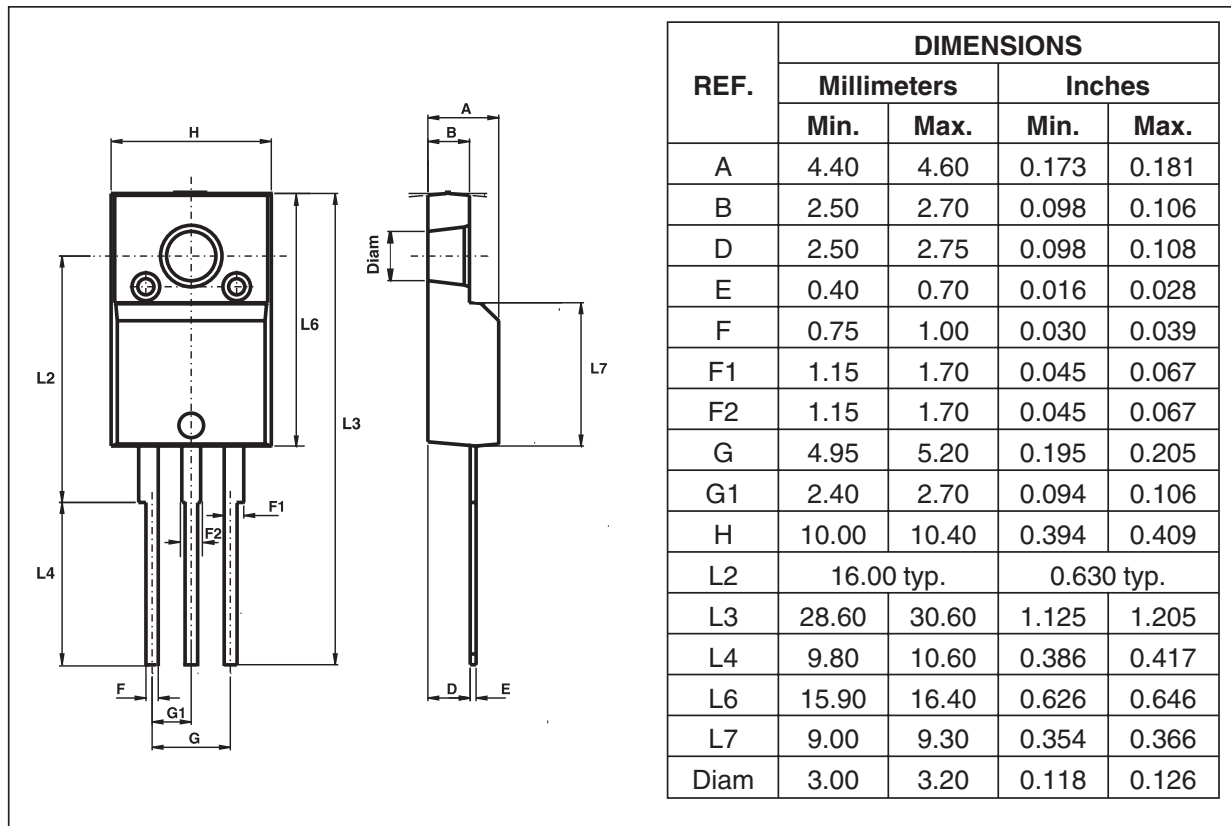

Fig. 9: Relative variation of critical rate of decrease of main current versus junction temperature.



PACKAGE MECHANICAL DATA
 ISOWATT220AB

- Cooling method : C
- Recommended torque value : 0.55 m.N.
- Maximum torque value : 0.70 m.N.

Information furnished is believed to be accurate and reliable. However, STMicroelectronics assumes no responsibility for the consequences of use of such information nor for any infringement of patents or other rights of third parties which may result from its use. No license is granted by implication or otherwise under any patent or patent rights of STMicroelectronics. Specifications mentioned in this publication are subject to change without notice. This publication supersedes and replaces all information previously supplied. STMicroelectronics products are not authorized for use as critical components in life support devices or systems without express written approval of STMicroelectronics.

The ST logo is a registered trademark of STMicroelectronics.

All other names are the property of their respective owners.

© 2004 STMicroelectronics - All rights reserved.



STMicroelectronics GROUP OF COMPANIES

Australia - Belgium - Brazil - Canada - China - Czech Republic - Finland - France - Germany -
 Hong Kong - India - Israel - Italy - Japan - Malaysia - Malta - Morocco - Singapore - Spain -
 Sweden - Switzerland - United Kingdom - United States

www.st.com

Looking for pricing, stock, or lifecycle information?

Click below to explore more details on WIN SOURCE:

-  [View T1630-600W](#) on WIN SOURCE
-  [STMicroelectronics](#) Information

Optimize Your Supply Chain with WIN SOURCE Solutions

-  Global Sourcing Solution
-  Obsolete Management
-  Cost Control Management
-  Shortage Management
-  Alternative Solution
-  Excess Inventory Management