



**THE DATASHEET OF  
SZBZX84C43ET1G**



# BZX84CxxxET1G Series, SZBZX84CxxxET1G Series

## Zener Voltage Regulators

### 250 mW SOT-23 Surface Mount

This series of Zener diodes is offered in the convenient, surface mount plastic SOT-23 package. These devices are designed to provide voltage regulation with minimum space requirement. They are well suited for applications such as cellular phones, hand held portables, and high density PC boards.

#### Specification Features

- 250 mW Rating on FR-4 or FR-5 Board
- Zener Breakdown Voltage Range – 2.4 V to 75 V
- Package Designed for Optimal Automated Board Assembly
- Small Package Size for High Density Applications
- ESD Rating of Class 3 (> 16 kV) per Human Body Model
- Peak Power – 225 W (8 X 20  $\mu$ s)
- SZ Prefix for Automotive and Other Applications Requiring Unique Site and Control Change Requirements; AEC-Q101 Qualified and PPAP Capable
- These Devices are Pb-Free and are RoHS Compliant

#### Mechanical Characteristics

**CASE:** Void-free, transfer-molded, thermosetting plastic case

**FINISH:** Corrosion resistant finish, easily solderable

**MAXIMUM CASE TEMPERATURE FOR SOLDERING PURPOSES:**

260°C for 10 Seconds

**POLARITY:** Cathode indicated by polarity band

**FLAMMABILITY RATING:** UL 94 V-0

#### MAXIMUM RATINGS

Rating	Symbol	Max	Unit
Peak Power Dissipation @ 20 $\mu$ s (Note 1) @ $T_L \leq 25^\circ\text{C}$	$P_{pk}$	225	W
Total Power Dissipation on FR-5 Board, (Note 2) @ $T_A = 25^\circ\text{C}$ Derated above 25°C Thermal Resistance, Junction-to-Ambient	$P_D$	250	mW
		2.0	mW/°C
		500	°C/W
Total Power Dissipation on Alumina Substrate, (Note 3) @ $T_A = 25^\circ\text{C}$ Derated above 25°C Thermal Resistance, Junction-to-Ambient	$P_D$	300	mW
		2.4	mW/°C
		417	°C/W
Junction and Storage Temperature Range	$T_J, T_{stg}$	-65 to +150	°C

Stresses exceeding those listed in the Maximum Ratings table may damage the device. If any of these limits are exceeded, device functionality should not be assumed, damage may occur and reliability may be affected.

1. Nonrepetitive current pulse per Figure 9.
2. FR-5 = 1.0 X 0.75 X 0.62 in.
3. Alumina = 0.4 X 0.3 X 0.024 in, 99.5% alumina.



**ON Semiconductor®**

[www.onsemi.com](http://www.onsemi.com)

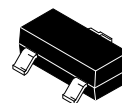

**SOT-23  
CASE 318  
STYLE 8**



#### MARKING DIAGRAM



xxx = Device Code  
M = Date Code\*  
▪ = Pb-Free Package

(Note: Microdot may be in either location)

\*Date Code orientation may vary depending upon manufacturing location.

#### ORDERING INFORMATION

Device	Package	Shipping <sup>†</sup>
BZX84CxxxET1G	SOT-23 (Pb-Free)	3,000 / Tape & Reel
SZBZX84CxxxET1G	SOT-23 (Pb-Free)	3,000 / Tape & Reel
BZX84CxxxET3G	SOT-23 (Pb-Free)	10,000 / Tape & Reel
SZBZX84CxxxET3G	SOT-23 (Pb-Free)	10,000 / Tape & Reel

<sup>†</sup>For information on tape and reel specifications, including part orientation and tape sizes, please refer to our Tape and Reel Packaging Specification Brochure, BRD8011/D.

#### DEVICE MARKING INFORMATION

See specific marking information in the device marking column of the Electrical Characteristics table on page 3 of this data sheet.

## BZX84CxxxET1G Series, SZBZX84CxxxET1G Series

### ELECTRICAL CHARACTERISTICS

(Pinout: 1-Anode, 2-No Connection, 3-Cathode) ( $T_A = 25^\circ\text{C}$  unless otherwise noted,  $V_F = 0.90\text{ V Max. @ } I_F = 10\text{ mA}$ )

Symbol	Parameter
$V_Z$	Reverse Zener Voltage @ $I_{ZT}$
$I_{ZT}$	Reverse Current
$Z_{ZT}$	Maximum Zener Impedance @ $I_{ZT}$
$I_R$	Reverse Leakage Current @ $V_R$
$V_R$	Reverse Voltage
$I_F$	Forward Current
$V_F$	Forward Voltage @ $I_F$
$\Theta V_Z$	Maximum Temperature Coefficient of $V_Z$
C	Max. Capacitance @ $V_R = 0$ and $f = 1\text{ MHz}$

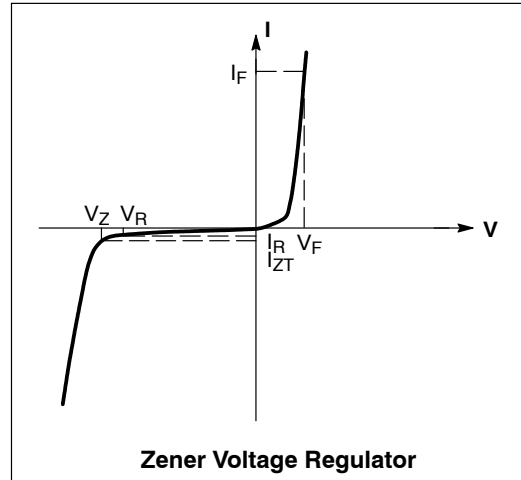

# BZX84CxxxET1G Series, SZBZX84CxxxET1G Series

## ELECTRICAL CHARACTERISTICS

(Pinout: 1-Anode, 2-No Connection, 3-Cathode) ( $T_A = 25^\circ\text{C}$  unless otherwise noted,  $V_F = 0.90\text{ V Max. @ } I_F = 10\text{ mA}$ )

Device*	Device Marking	$V_{Z1}$ (V) @ $I_{ZT1} = 5\text{ mA}$ (Note 4)			$Z_{ZT1}$ ( $\Omega$ ) @ $I_{ZT1} = 5\text{ mA}$	$V_{Z2}$ (V) @ $I_{ZT2} = 1\text{ mA}$ (Note 4)		$Z_{ZT2}$ ( $\Omega$ ) @ $I_{ZT2} = 1\text{ mA}$	$V_{Z3}$ (V) @ $I_{ZT3} = 20\text{ mA}$ (Note 4)		$Z_{ZT3}$ ( $\Omega$ ) @ $I_{ZT3} = 20\text{ mA}$	Max Reverse Leakage Current		$\theta_{VZ}$ (mV/k) @ $I_{ZT1} = 5\text{ mA}$		C (pF) @ $V_R = 0\text{ V}$ $f = 1\text{ MHz}$
		Min	Nom	Max		Min	Max		Min	Max		$I_R$ ( $\mu\text{A}$ )	$V_R$ (V)	Min	Max	
BZX84C2V4ET1G	BA1	2.2	2.4	2.6	100	1.7	2.1	600	2.6	3.2	50	50	1.0	-3.5	0	450
BZX84C2V7ET1G	BA2	2.5	2.7	2.9	100	1.9	2.4	600	3.0	3.6	50	20	1.0	-3.5	0	450
BZX84C3V0ET1G	BA3	2.8	3.0	3.2	95	2.1	2.7	600	3.3	3.9	50	10	1.0	-3.5	0	450
BZX84C3V3ET1G	BA4	3.1	3.3	3.5	95	2.3	2.9	600	3.6	4.2	40	5.0	1.0	-3.5	0	450
BZX84C3V6ET1G	BA5	3.4	3.6	3.8	90	2.7	3.3	600	3.9	4.5	40	5.0	1.0	-3.5	0	450
BZX84C3V9ET1G	BA6	3.7	3.9	4.1	90	2.9	3.5	600	4.1	4.7	30	3.0	1.0	-3.5	-2.5	450
BZX84C4V3ET1G	BA7	4.0	4.3	4.6	90	3.3	4.0	600	4.4	5.1	30	3.0	1.0	-3.5	0	450
BZX84C4V7ET1G	BA9	4.4	4.7	5.0	80	3.7	4.7	500	4.5	5.4	15	3.0	2.0	-3.5	0.2	260
BZX84C5V1ET1G	BB1	4.8	5.1	5.4	60	4.2	5.3	480	5.0	5.9	15	2.0	2.0	-2.7	1.2	225
BZX84C5V6ET1G	BB2	5.2	5.6	6.0	40	4.8	6.0	400	5.2	6.3	10	1.0	2.0	-2	2.5	200
BZX84C6V2ET1G	BB3	5.8	6.2	6.6	10	5.6	6.6	150	5.8	6.8	6	3.0	4.0	0.4	3.7	185
BZX84C6V8ET1G	BB4	6.4	6.8	7.2	15	6.3	7.2	80	6.4	7.4	6	2.0	4.0	1.2	4.5	155
BZX84C7V5ET1G	BB5	7.0	7.5	7.9	15	6.9	7.9	80	7.0	8.0	6	1.0	5.0	2.5	5.3	140
BZX84C8V2ET1G	BB6	7.7	8.2	8.7	15	7.6	8.7	80	7.7	8.8	6	0.7	5.0	3.2	6.2	135
BZX84C9V1ET1G	BB7	8.5	9.1	9.6	15	8.4	9.6	100	8.5	9.7	8	0.5	6.0	3.8	7.0	130
BZX84C10ET1G	BB8	9.4	10	10.6	20	9.3	10.6	150	9.4	10.7	10	0.2	7.0	4.5	8.0	130
BZX84C11ET1G	BB9	10.4	11	11.6	20	10.2	11.6	150	10.4	11.8	10	0.1	8.0	5.4	9.0	130
BZX84C12ET1G	BC1	11.4	12	12.7	25	11.2	12.7	150	11.4	12.9	10	0.1	8.0	6.0	10	130
BZX84C13ET1G	BC2	12.4	13	14.1	30	12.3	14	170	12.5	14.2	15	0.1	8.0	7.0	11	120
BZX84C15ET1G	BC3	13.8	15	15.6	30	13.7	15.5	200	13.9	15.7	20	0.05	10.5	9.2	13	110
BZX84C16ET1G	BC4	15.3	16	17.1	40	15.2	17	200	15.4	17.2	20	0.05	11.2	10.4	14	105
BZX84C18ET1G	BC5	16.8	18	19.1	45	16.7	19	225	16.9	19.2	20	0.05	12.6	12.4	16	100
BZX84C20ET1G	BC6	18.8	20	21.2	55	18.7	21.1	225	18.9	21.4	20	0.05	14	14.4	18	85
BZX84C22ET1G	BC7	20.8	22	23.3	55	20.7	23.2	250	20.9	23.4	25	0.05	15.4	16.4	20	85
BZX84C24ET1G	BC8	22.8	24	25.6	70	22.7	25.5	250	22.9	25.7	25	0.05	16.8	18.4	22	80
Device*	Device Marking	$V_{Z1}$ Below @ $I_{ZT1} = 2\text{ mA}$			$Z_{ZT1}$ Below @ $I_{ZT1} = 2\text{ mA}$	$V_{Z2}$ Below @ $I_{ZT2} = 0.1\text{ mA}$		$Z_{ZT2}$ Below @ $I_{ZT4} = 0.5\text{ mA}$	$V_{Z3}$ Below @ $I_{ZT3} = 10\text{ mA}$		$Z_{ZT3}$ Below @ $I_{ZT3} = 10\text{ mA}$	Max Reverse Leakage Current		$\theta_{VZ}$ (mV/k) Below @ $I_{ZT1} = 2\text{ mA}$		C (pF) @ $V_R = 0\text{ V}$ $f = 1\text{ MHz}$
		Min	Nom	Max		Min	Max		Min	Max		$I_R$ ( $\mu\text{A}$ )	$V_R$ (V)	Min	Max	
BZX84C27ET1G	BC9	25.1	27	28.9	80	25	28.9	300	25.2	29.3	45	0.05	18.9	21.4	25.3	70
BZX84C30ET1G	BD1	28	30	32	80	27.8	32	300	28.1	32.4	50	0.05	21	24.4	29.4	70
BZX84C33ET1G	BD2	31	33	35	80	30.8	35	325	31.1	35.4	55	0.05	23.1	27.4	33.4	70
BZX84C36ET1G	BD3	34	36	38	90	33.8	38	350	34.1	38.4	60	0.05	25.2	30.4	37.4	70
BZX84C39ET1G	BD4	37	39	41	130	36.7	41	350	37.1	41.5	70	0.05	27.3	33.4	41.2	45
BZX84C43ET1G	BK6	40	43	46	150	39.7	46	375	40.1	46.5	80	0.05	30.1	37.6	46.6	40
BZX84C47ET1G	BD5	44	47	50	170	43.7	50	375	44.1	50.5	90	0.05	32.9	42	51.8	40
BZX84C51ET1G	BD6	48	51	54	180	47.6	54	400	48.1	54.6	100	0.05	35.7	46.6	57.2	40
BZX84C56ET1G	BD7	52	56	60	200	51.5	60	425	52.1	60.8	110	0.05	39.2	52.2	63.8	40
BZX84C62ET1G	BD8	58	62	66	215	57.4	66	450	58.2	67	120	0.05	43.4	58.8	71.6	35
BZX84C68ET1G	BD9	64	68	72	240	63.4	72	475	64.2	73.2	130	0.05	47.6	65.6	79.8	35
BZX84C75ET1G	BE1	70	75	79	255	69.4	79	500	70.3	80.2	140	0.05	52.5	73.4	88.6	35

Product parametric performance is indicated in the Electrical Characteristics for the listed test conditions, unless otherwise noted. Product performance may not be indicated by the Electrical Characteristics if operated under different conditions.

4. Zener voltage is measured with a pulse test current  $I_Z$  at an ambient temperature of  $25^\circ\text{C}$

\* Include SZ-prefix devices where applicable.

# BZX84CxxxET1G Series, SZBZX84CxxxET1G Series

## TYPICAL CHARACTERISTICS

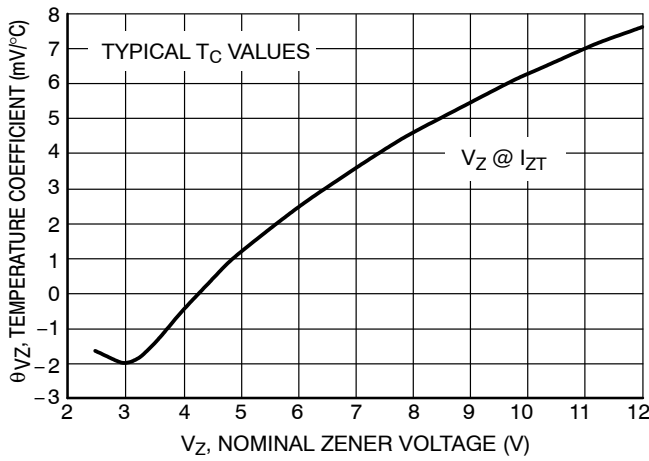

**Figure 1. Temperature Coefficients  
(Temperature Range -55°C to +150°C)**

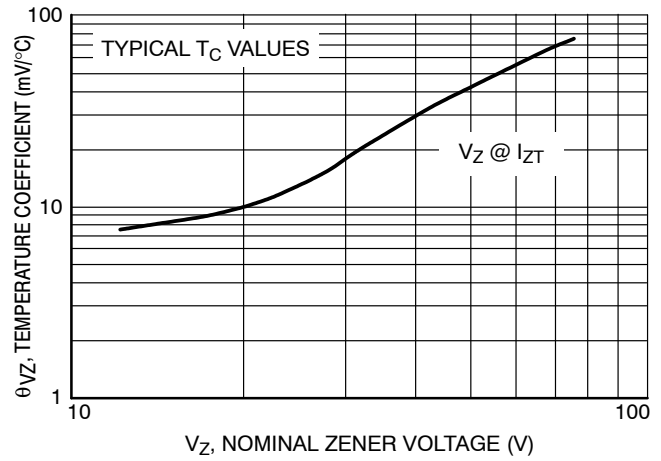

**Figure 2. Temperature Coefficients  
(Temperature Range -55°C to +150°C)**

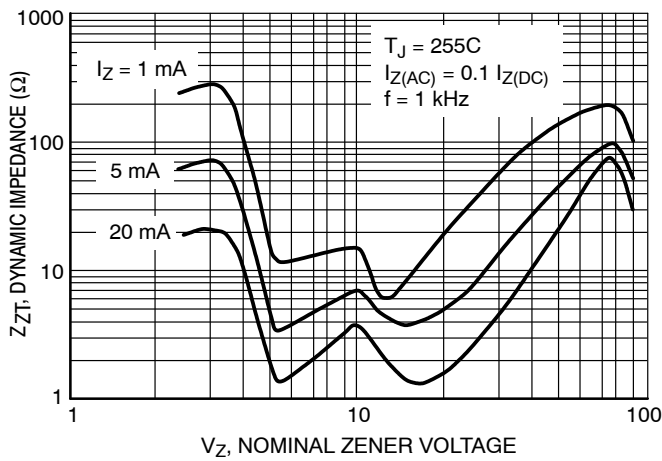

**Figure 3. Effect of Zener Voltage on  
Zener Impedance**



**Figure 4. Typical Forward Voltage**

# BZX84CxxxET1G Series, SZBZX84CxxxET1G Series

## TYPICAL CHARACTERISTICS

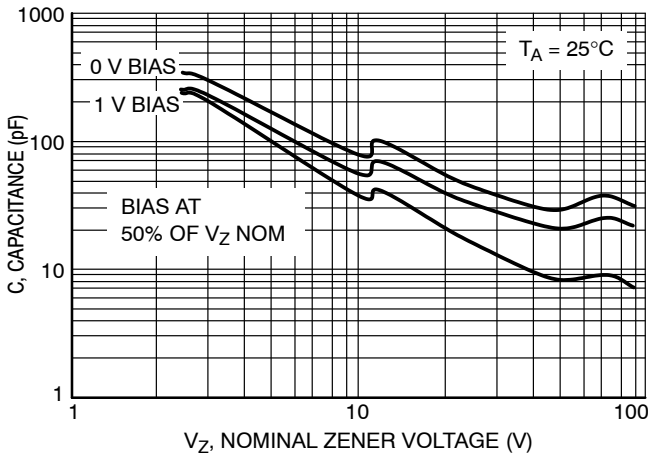

Figure 5. Typical Capacitance



Figure 6. Typical Leakage Current

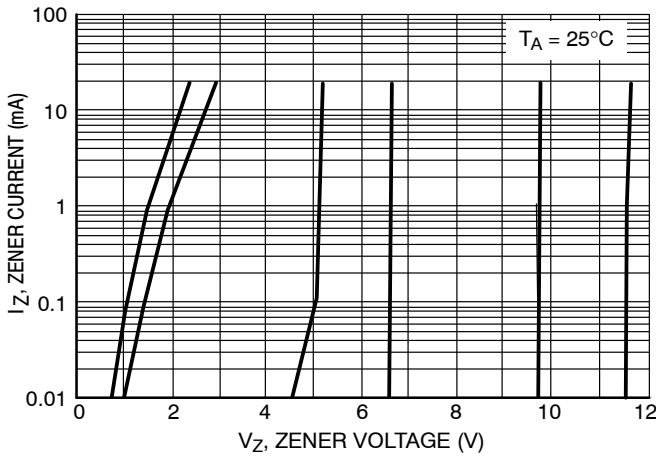

Figure 7. Zener Voltage versus Zener Current  
( $V_Z$  Up to 12 V)



Figure 8. Zener Voltage versus Zener Current  
(12 V to 91 V)

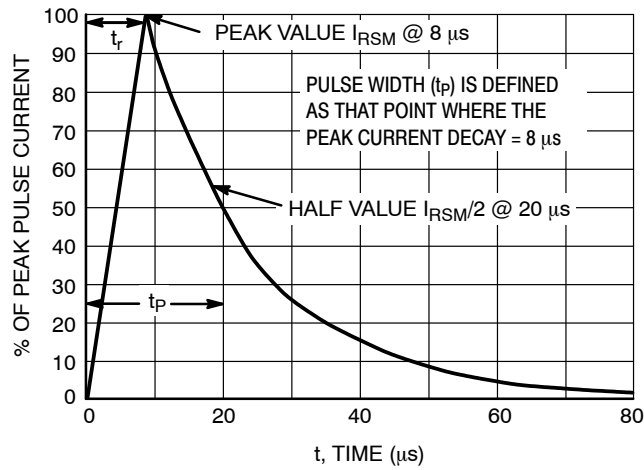
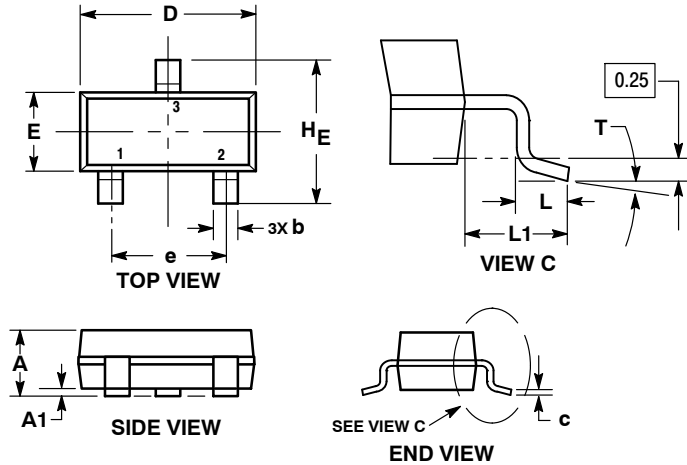

Figure 9.  $8 \times 20 \mu\text{s}$  Pulse Waveform

# BZX84CxxxET1G Series, SZBZX84CxxxET1G Series

## PACKAGE DIMENSIONS

SOT-23 (TO-236)  
CASE 318-08  
ISSUE AR



**NOTES:**

1. DIMENSIONING AND TOLERANCING PER ASME Y14.5M, 1994.
2. CONTROLLING DIMENSION: MILLIMETERS.
3. MAXIMUM LEAD THICKNESS INCLUDES LEAD FINISH. MINIMUM LEAD THICKNESS IS THE MINIMUM THICKNESS OF THE BASE MATERIAL.
4. DIMENSIONS D AND E DO NOT INCLUDE MOLD FLASH, PROTRUSIONS, OR GATE BURRS.

DIM	MILLIMETERS			INCHES		
	MIN	NOM	MAX	MIN	NOM	MAX
A	0.89	1.00	1.11	0.035	0.039	0.044
A1	0.01	0.06	0.10	0.000	0.002	0.004
b	0.37	0.44	0.50	0.015	0.017	0.020
c	0.08	0.14	0.20	0.003	0.006	0.008
D	2.80	2.90	3.04	0.110	0.114	0.120
E	1.20	1.30	1.40	0.047	0.051	0.055
e	1.78	1.90	2.04	0.070	0.075	0.080
L	0.30	0.43	0.55	0.012	0.017	0.022
L1	0.35	0.54	0.69	0.014	0.021	0.027
HE	2.10	2.40	2.64	0.083	0.094	0.104
T	0°	---	10°	0°	---	10°

**STYLE 8:**

1. ANODE
2. NO CONNECTION
3. CATHODE

### RECOMMENDED SOLDERING FOOTPRINT\*

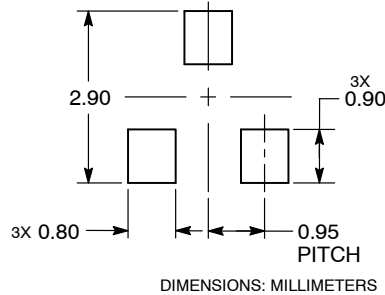

\*For additional information on our Pb-Free strategy and soldering details, please download the ON Semiconductor Soldering and Mounting Techniques Reference Manual, SOLDERRM/D.

ON Semiconductor and are trademarks of Semiconductor Components Industries, LLC dba ON Semiconductor or its subsidiaries in the United States and/or other countries. ON Semiconductor owns the rights to a number of patents, trademarks, copyrights, trade secrets, and other intellectual property. A listing of ON Semiconductor's product/patent coverage may be accessed at [www.onsemi.com/site/pdf/Patent-Marking.pdf](http://www.onsemi.com/site/pdf/Patent-Marking.pdf). ON Semiconductor reserves the right to make changes without further notice to any products herein. ON Semiconductor makes no warranty, representation or guarantee regarding the suitability of its products for any particular purpose, nor does ON Semiconductor assume any liability arising out of the application or use of any product or circuit, and specifically disclaims any and all liability, including without limitation special, consequential or incidental damages. Buyer is responsible for its products and applications using ON Semiconductor products, including compliance with all laws, regulations and safety requirements or standards, regardless of any support or applications information provided by ON Semiconductor. "Typical" parameters which may be provided in ON Semiconductor data sheets and/or specifications can and do vary in different applications and actual performance may vary over time. All operating parameters, including "Typicals" must be validated for each customer application by customer's technical experts. ON Semiconductor does not convey any license under its patent rights nor the rights of others. ON Semiconductor products are not designed, intended, or authorized for use as a critical component in life support systems or any FDA Class 3 medical devices or medical devices with a same or similar classification in a foreign jurisdiction or any devices intended for implantation in the human body. Should Buyer purchase or use ON Semiconductor products for any such unintended or unauthorized application, Buyer shall indemnify and hold ON Semiconductor and its officers, employees, subsidiaries, affiliates, and distributors harmless against all claims, costs, damages, and expenses, and reasonable attorney fees arising out of, directly or indirectly, any claim of personal injury or death associated with such unintended or unauthorized use, even if such claim alleges that ON Semiconductor was negligent regarding the design or manufacture of the part. ON Semiconductor is an Equal Opportunity/Affirmative Action Employer. This literature is subject to all applicable copyright laws and is not for resale in any manner.

### PUBLICATION ORDERING INFORMATION

**LITERATURE FULFILLMENT:**  
Literature Distribution Center for ON Semiconductor  
19521 E. 32nd Pkwy, Aurora, Colorado 80011 USA  
**Phone:** 303-675-2175 or 800-344-3860 Toll Free USA/Canada  
**Fax:** 303-675-2176 or 800-344-3867 Toll Free USA/Canada  
**Email:** [orderlit@onsemi.com](mailto:orderlit@onsemi.com)

**N. American Technical Support:** 800-282-9855 Toll Free  
USA/Canada  
**Europe, Middle East and Africa Technical Support:**  
Phone: 421 33 790 2910  
**Japan Customer Focus Center**  
Phone: 81-3-5817-1050

**ON Semiconductor Website:** [www.onsemi.com](http://www.onsemi.com)  
**Order Literature:** <http://www.onsemi.com/orderlit>

For additional information, please contact your local Sales Representative

## Looking for pricing, stock, or lifecycle information?

Click below to explore more details on WIN SOURCE:

 [View SZBZX84C43ET1G on WIN SOURCE](#)

 [ON Semiconductor](#) Information

## Optimize Your Supply Chain with WIN SOURCE Solutions

-  Global Sourcing Solution
-  Obsolete Management
-  Cost Control Management
-  Shortage Management
-  Alternative Solution
-  Excess Inventory Management