



Is Now Part of



ON Semiconductor®

To learn more about ON Semiconductor, please visit our website at
www.onsemi.com

Please note: As part of the Fairchild Semiconductor integration, some of the Fairchild orderable part numbers will need to change in order to meet ON Semiconductor's system requirements. Since the ON Semiconductor product management systems do not have the ability to manage part nomenclature that utilizes an underscore (_), the underscore (_) in the Fairchild part numbers will be changed to a dash (-). This document may contain device numbers with an underscore (_). Please check the ON Semiconductor website to verify the updated device numbers. The most current and up-to-date ordering information can be found at www.onsemi.com. Please email any questions regarding the system integration to Fairchild_questions@onsemi.com.

ON Semiconductor and the ON Semiconductor logo are trademarks of Semiconductor Components Industries, LLC dba ON Semiconductor or its subsidiaries in the United States and/or other countries. ON Semiconductor owns the rights to a number of patents, trademarks, copyrights, trade secrets, and other intellectual property. A listing of ON Semiconductor's product/patent coverage may be accessed at www.onsemi.com/site/pdf/Patent-Marking.pdf. ON Semiconductor reserves the right to make changes without further notice to any products herein. ON Semiconductor makes no warranty, representation or guarantee regarding the suitability of its products for any particular purpose, nor does ON Semiconductor assume any liability arising out of the application or use of any product or circuit, and specifically disclaims any and all liability, including without limitation special, consequential or incidental damages. Buyer is responsible for its products and applications using ON Semiconductor products, including compliance with all laws, regulations and safety requirements or standards, regardless of any support or applications information provided by ON Semiconductor. "Typical" parameters which may be provided in ON Semiconductor data sheets and/or specifications can and do vary in different applications and actual performance may vary over time. All operating parameters, including "Typicals" must be validated for each customer application by customer's technical experts. ON Semiconductor does not convey any license under its patent rights nor the rights of others. ON Semiconductor products are not designed, intended, or authorized for use as a critical component in life support systems or any FDA Class 3 medical devices or medical devices with a same or similar classification in a foreign jurisdiction or any devices intended for implantation in the human body. Should Buyer purchase or use ON Semiconductor products for any such unintended or unauthorized application, Buyer shall indemnify and hold ON Semiconductor and its officers, employees, subsidiaries, affiliates, and distributors harmless against all claims, costs, damages, and expenses, and reasonable attorney fees arising out of, directly or indirectly, any claim of personal injury or death associated with such unintended or unauthorized use, even if such claim alleges that ON Semiconductor was negligent regarding the design or manufacture of the part. ON Semiconductor is an Equal Opportunity/Affirmative Action Employer. This literature is subject to all applicable copyright laws and is not for resale in any manner.

74LVT16373 • 74LVTH16373

Low Voltage 16-Bit Transparent Latch with 3-STATE Outputs

General Description

The LVT16373 and LVTH16373 contain sixteen non-inverting latches with 3-STATE outputs and is intended for bus oriented applications. The device is byte controlled. The flip-flops appear transparent to the data when the Latch Enable (LE) is HIGH. When LE is LOW, the data that meets the setup time is latched. Data appears on the bus when the Output Enable (\overline{OE}) is LOW. When \overline{OE} is HIGH, the outputs are in a high impedance state.

The LVTH16373 data inputs include bushold, eliminating the need for external pull-up resistors to hold unused inputs.

These latches are designed for low-voltage (3.3V) V_{CC} applications, but with the capability to provide a TTL interface to a 5V environment. The LVT16373 and LVTH16373 are fabricated with an advanced BiCMOS technology to achieve high speed operation similar to 5V ABT while maintaining a low power dissipation.

Features

- Input and output interface capability to systems at 5V V_{CC}
- Bushold data inputs eliminate the need for external pull-up resistors to hold unused inputs (74LVTH16373), also available without bushold feature (74LVT16373)
- Live insertion/extraction permitted
- Power Up/Power Down high impedance provides glitch-free bus loading
- Outputs source/sink -32 mA/+64 mA
- Functionally compatible with the 74 series 16373
- Latch-up performance exceeds 500 mA
- ESD performance:
 - Human-body model > 2000V
 - Machine model > 200V
 - Charged-device model > 1000V
- Also packaged in plastic Fine-Pitch Ball Grid Array (FBGA) (Preliminary)

Ordering Code:

Order Number	Package Number	Package Description
74LVT16373GX (Note 1)	BGA54A (Preliminary)	54-Ball Fine-Pitch Ball Grid Array (FBGA), JEDEC MO-205, 5.5mm Wide [TAPE and REEL]
74LVT16373MEA (Note 2)	MS48A	48-Lead Small Shrink Outline Package (SSOP), JEDEC MO-118, 0.300" Wide
74LVT16373MTD (Note 2)	MTD48	48-Lead Thin Shrink Small Outline Package (TSSOP), JEDEC MO-153, 6.1mm Wide
74LVTH16373GX (Note 1)	BGA54A (Preliminary)	54-Ball Fine-Pitch Ball Grid Array (FBGA), JEDEC MO-205, 5.5mm Wide [TAPE and REEL]
74LVTH16373MEA (Note 2)	MS48A	48-Lead Small Shrink Outline Package (SSOP), JEDEC MO-118, 0.300" Wide
74LVTH16373MTD (Note 2)	MTD48	48-Lead Thin Shrink Small Outline Package (TSSOP), JEDEC MO-153, 6.1mm Wide

Note 1: BGA package available in Tape and Reel only.

Note 2: Device also available in Tape and Reel. Specify by appending suffix letter "X" to the ordering code.

Logic Symbol

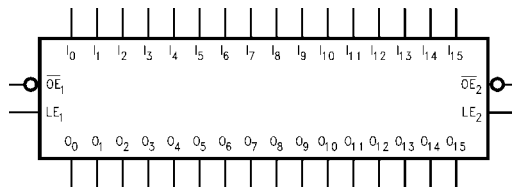

74LVT16373 • 74LVTH16373 Low Voltage 16-Bit Transparent Latch with 3-STATE Outputs

Connection Diagrams

Pin Assignment for SSOP and TSSOP

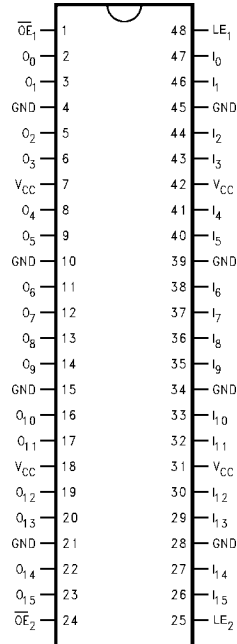

Pin Assignment for FBGA

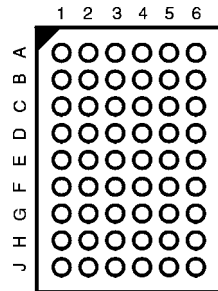

(Top Thru View)

Pin Descriptions

Pin Names	Description
\overline{OE}_n	Output Enable Input (Active LOW)
LE_n	Latch Enable Input
I_0-I_{15}	Inputs
O_0-O_{15}	3-STATE Outputs
NC	No Connect

FBGA Pin Assignments

	1	2	3	4	5	6
A	O_0	NC	\overline{OE}_1	LE_1	NC	I_0
B	O_2	O_1	NC	NC	I_1	I_2
C	O_4	O_3	V_{CC}	V_{CC}	I_3	I_4
D	O_6	O_5	GND	GND	I_5	I_6
E	O_8	O_7	GND	GND	I_7	I_8
F	O_{10}	O_9	GND	GND	I_9	I_{10}
G	O_{12}	O_{11}	V_{CC}	V_{CC}	I_{11}	I_{12}
H	O_{14}	O_{13}	NC	NC	I_{13}	I_{14}
J	O_{15}	NC	\overline{OE}_2	LE_2	NC	I_{15}

Truth Tables

Inputs			Outputs
LE_1	\overline{OE}_1	I_0-I_7	O_0-O_7
X	H	X	Z
H	L	L	L
H	L	H	H
L	L	X	O_0

Inputs			Outputs
LE_2	\overline{OE}_2	I_8-I_{15}	O_8-O_{15}
X	H	X	Z
H	L	L	L
H	L	H	H
L	L	X	O_0

H = HIGH Voltage Level
 L = LOW Voltage Level
 X = Immaterial
 Z = HIGH Impedance
 O_0 = Previous output prior to HIGH-to-LOW transition of LE

Functional Description

The LVT16373 and LVTH16373 contain sixteen D-type latches with 3-STATE standard outputs. The device is byte controlled with each byte functioning identically, but independent of the other. Control pins can be shorted together to obtain full 16-bit operation. The following description applies to each byte. When the Latch Enable (LE_n) input is HIGH, data on the D_n enters the latches. In this condition the latches are transparent, i.e., a latch output will change states each time its D input changes. When LE_n is LOW,

the latches store information that was present on the D inputs a setup time preceding the HIGH-to-LOW transition of LE_n . The 3-STATE standard outputs are controlled by the Output Enable (\overline{OE}_n) input. When \overline{OE}_n is LOW, the standard outputs are in the 2-state mode. When \overline{OE}_n is HIGH, the standard outputs are in the high impedance mode but this does not interfere with entering new data into the latches.

Logic Diagrams

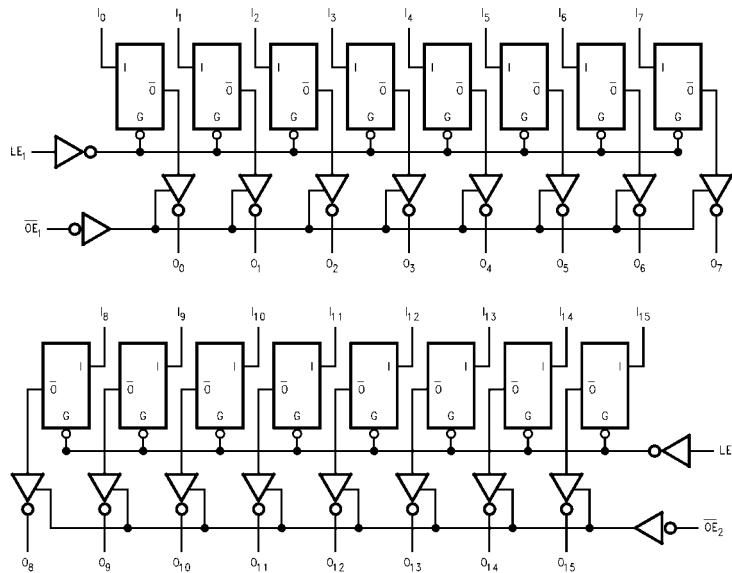

Please note that these diagrams are provided only for the understanding of logic operations and should not be used to estimate propagation delays.

Absolute Maximum Ratings (Note 3)					
Symbol	Parameter	Value	Conditions		Units
V_{CC}	Supply Voltage	-0.5 to +4.6			V
V_I	DC Input Voltage	-0.5 to +7.0			V
V_O	DC Output Voltage	-0.5 to +7.0	Output in 3-STATE		V
		-0.5 to +7.0	Output in HIGH or LOW State (Note 4)		
I_{IK}	DC Input Diode Current	-50	$V_I < GND$		mA
I_{OK}	DC Output Diode Current	-50	$V_O < GND$		mA
I_O	DC Output Current	64	$V_O > V_{CC}$ Output at HIGH State		mA
		128	$V_O > V_{CC}$ Output at LOW State		
I_{CC}	DC Supply Current per Supply Pin	±64			mA
I_{GND}	DC Ground Current per Ground Pin	±128			mA
T_{STG}	Storage Temperature	-65 to +150			°C

Recommended Operating Conditions					
Symbol	Parameter	Min	Max	Units	
V_{CC}	Supply Voltage	2.7	3.6	V	
V_I	Input Voltage	0	5.5	V	
I_{OH}	HIGH Level Output Current		-32	mA	
I_{OL}	LOW Level Output Current		64	mA	
T_A	Free-Air Operating Temperature	-40	85	°C	
$\Delta t/\Delta V$	Input Edge Rate, $V_{IN} = 0.8V-2.0V$, $V_{CC} = 3.0V$	0	10	ns/V	

Note 3: Absolute Maximum continuous ratings are those values beyond which damage to the device may occur. Exposure to these conditions or conditions beyond those indicated may adversely affect device reliability. Functional operation under absolute maximum rated conditions is not implied.

Note 4: I_O Absolute Maximum Rating must be observed.

DC Electrical Characteristics

Symbol	Parameter	V_{CC} (V)	$T_A = -40^\circ\text{C to } +85^\circ\text{C}$		Units	Conditions	
			Min	Max			
V_{IK}	Input Clamp Diode Voltage	2.7		-1.2	V	$I_I = -18\text{ mA}$	
V_{IH}	Input HIGH Voltage	2.7-3.6	2.0		V	$V_O \leq 0.1V$ or $V_O \geq V_{CC} - 0.1V$	
V_{IL}	Input LOW Voltage	2.7-3.6		0.8	V		
V_{OH}	Output HIGH Voltage	2.7-3.6	$V_{CC} - 0.2$		V	$I_{OH} = -100\ \mu\text{A}$	
		2.7	2.4			$I_{OH} = -8\text{ mA}$	
		3.0	2.0			$I_{OH} = -32\text{ mA}$	
V_{OL}	Output LOW Voltage	2.7		0.2	V	$I_{OL} = 100\ \mu\text{A}$	
		2.7		0.5		$I_{OL} = 24\text{ mA}$	
		3.0		0.4		$I_{OL} = 16\text{ mA}$	
		3.0		0.5		$I_{OL} = 32\text{ mA}$	
		3.0		0.55		$I_{OL} = 64\text{ mA}$	
$I_{I(HOLD)}$ (Note 5)	Bushold Input Minimum Drive	3.0	75		μA	$V_I = 0.8V$	
			-75			$V_I = 2.0V$	
$I_{I(OD)}$ (Note 5)	Bushold Input Over-Drive Current to Change State	3.0	500		μA	(Note 6)	
			-500			(Note 7)	
I_I	Input Current	3.6		10	μA	$V_I = 5.5V$	
		Control Pins	3.6			±1	$V_I = 0V$ or V_{CC}
			Data Pins	3.6			-5
				1		$V_I = V_{CC}$	
I_{OFF}	Power Off Leakage Current	0		±100	μA	$0V \leq V_I$ or $V_O \leq 5.5V$	
$I_{PU/PD}$	Power Up/Down 3-STATE Output Current	0-1.5V		±100	μA	$V_O = 0.5V$ to $3.0V$ $V_I = GND$ or V_{CC}	
I_{OZL}	3-STATE Output Leakage Current	3.6		-5	μA	$V_O = 0.5V$	
I_{OZH}	3-STATE Output Leakage Current	3.6		5	μA	$V_O = 3.0V$	
I_{OZH+}	3-STATE Output Leakage Current	3.6		10	μA	$V_{CC} < V_O \leq 5.5V$	

DC Electrical Characteristics (Continued)

Symbol	Parameter	V _{CC} (V)	T _A = -40°C to +85°C		Units	Conditions
			Min	Max		
I _{CCH}	Power Supply Current	3.6		0.19	mA	Outputs HIGH
I _{CCL}	Power Supply Current	3.6		5	mA	Outputs LOW
I _{CCZ}	Power Supply Current	3.6		0.19	mA	Outputs Disabled
I _{CCZ} [†]	Power Supply Current	3.6		0.19	mA	V _{CC} ≤ V _O ≤ 5.5V, Outputs Disabled
ΔI _{CC}	Increase in Power Supply Current (Note 8)	3.6		0.2	mA	One Input at V _{CC} - 0.6V Other Inputs at V _{CC} or GND

Note 5: Applies to bushold versions only (74LVTH16373).

Note 6: An external driver must source at least the specified current to switch from LOW-to-HIGH.

Note 7: An external driver must sink at least the specified current to switch from HIGH-to-LOW.

Note 8: This is the increase in supply current for each input that is at the specified voltage level rather than V_{CC} or GND.

Dynamic Switching Characteristics (Note 9)

Symbol	Parameter	V _{CC} (V)	T _A = 25°C			Units	Conditions C _L = 50 pF, R _L = 500Ω
			Min	Typ	Max		
V _{OLP}	Quiet Output Maximum Dynamic V _{OL}	3.3		0.8		V	(Note 10)
V _{OLV}	Quiet Output Minimum Dynamic V _{OL}	3.3		-0.8		V	(Note 10)

Note 9: Characterized in SSOP package. Guaranteed parameter, but not tested.

Note 10: Max number of outputs defined as (n), n-1 data inputs are driven 0V to 3V. Output under test held LOW.

AC Electrical Characteristics

Symbol	Parameter	T _A = -40°C to +85°C, C _L = 50pF, R _L = 500Ω				Units
		V _{CC} = 3.3V ± 0.3V		V _{CC} = 2.7V		
		Min	Max	Min	Max	
t _{PHL}	Propagation Delay D _n to O _n	1.5	3.9	1.5	4.3	ns
t _{PLH}	Propagation Delay LE to O _n	1.5	3.8	1.5	4.2	
t _{PHL}	Propagation Delay LE to O _n	1.9	4.2	1.9	4.4	ns
t _{PLH}	Propagation Delay D _n to O _n	1.6	4.3	1.6	4.8	
t _{PZL}	Output Enable Time	1.3	4.3	1.3	4.9	ns
t _{PZH}	Output Disable Time	1.0	4.3	1.0	5.1	
t _{PLZ}	Output Enable Time	1.5	4.7	1.5	4.8	ns
t _{PHZ}	Output Disable Time	2.0	5.0	2.0	5.4	
t _S	Setup Time, D _n to LE	1.0		0.8		ns
t _H	Hold Time, D _n to LE	1.0		1.1		ns
t _W	LE Pulse Width	3.0		3.0		ns
t _{OSHL}	Output to Output Skew (Note 11)		1.0		1.0	ns
t _{OSLH}	Output to Output Skew (Note 11)		1.0		1.0	

Note 11: Skew is defined as the absolute value of the difference between the actual propagation delay for any two separate outputs of the same device. The specification applies to any outputs switching in the same direction, either HIGH-to-LOW (t_{OSHL}) or LOW-to-HIGH (t_{OSLH}).

Capacitance (Note 12)

Symbol	Parameter	Conditions	Typical	Units
C _{IN}	Input Capacitance	V _{CC} = Open, V _I = 0V or V _{CC}	4	pF
C _{OUT}	Output Capacitance	V _{CC} = 3.0V, V _O = 0V or V _{CC}	8	pF

Note 12: Capacitance is measured at frequency f = 1 MHz, per MIL-STD-883, Method 3012.

Physical Dimensions inches (millimeters) unless otherwise noted

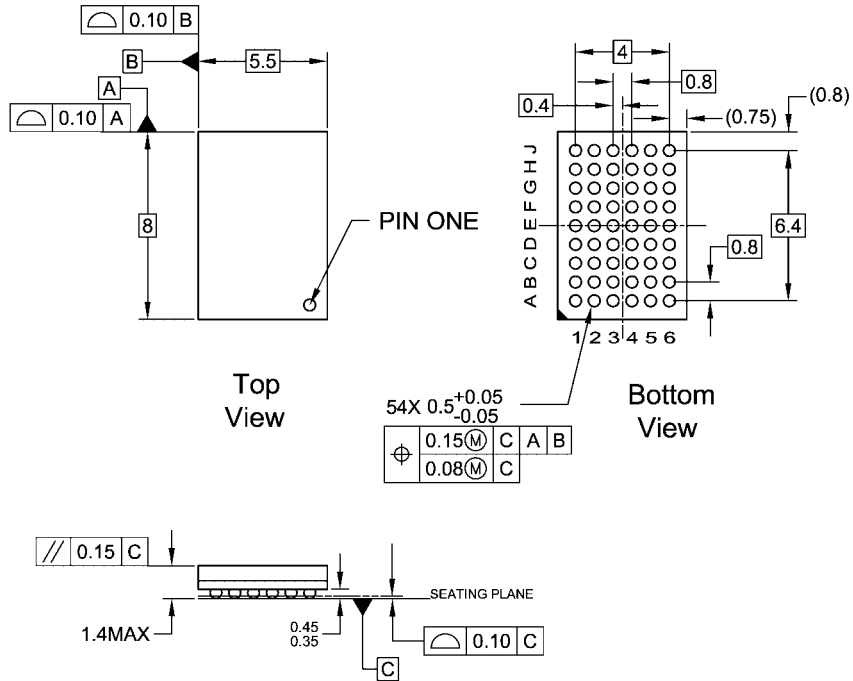

NOTES:

- A. THIS PACKAGE CONFORMS TO JEDEC M0-205
- B. ALL DIMENSIONS IN MILLIMETERS
- C. LAND PATTERN RECOMMENDATION: NSMD (Non Solder Mask Defined)
.35MM DIA PADS WITH A SOLDERMASK OPENING OF .45MM CONCENTRIC TO PADS
- D. DRAWING CONFORMS TO ASME Y14.5M-1994

BGA54ArevD

54-Ball Fine-Pitch Ball Grid Array (FBGA), JEDEC MO-205, 5.5mm Wide
Package Number BGA54A
Preliminary

Physical Dimensions inches (millimeters) unless otherwise noted (Continued)

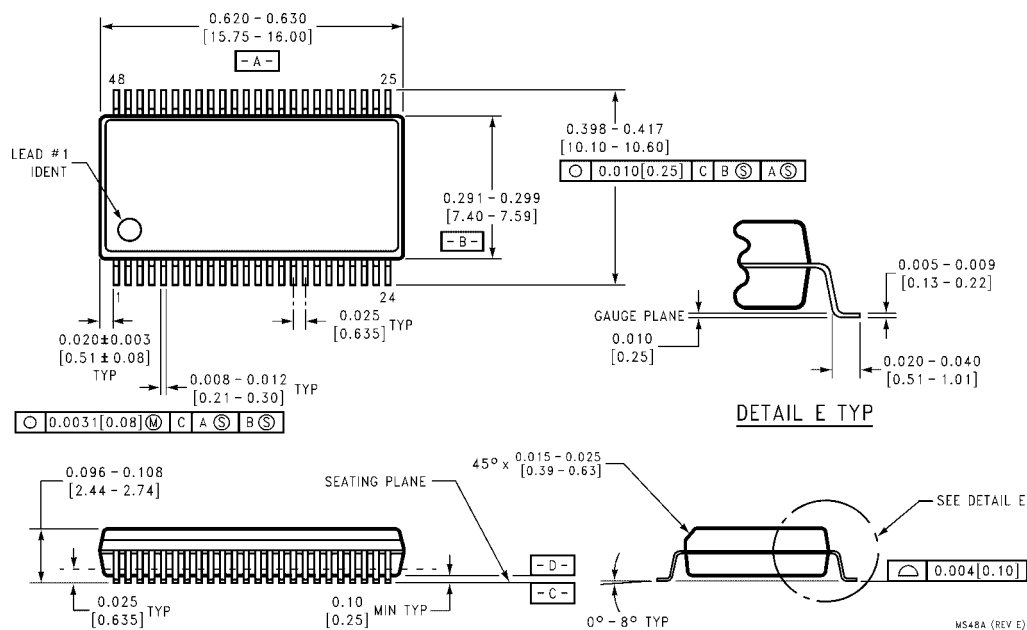

**48-Lead Small Shrink Outline Package (SSOP), JEDEC MO-118, 0.300" Wide
Package Number MS48A**

Physical Dimensions inches (millimeters) unless otherwise noted (Continued)

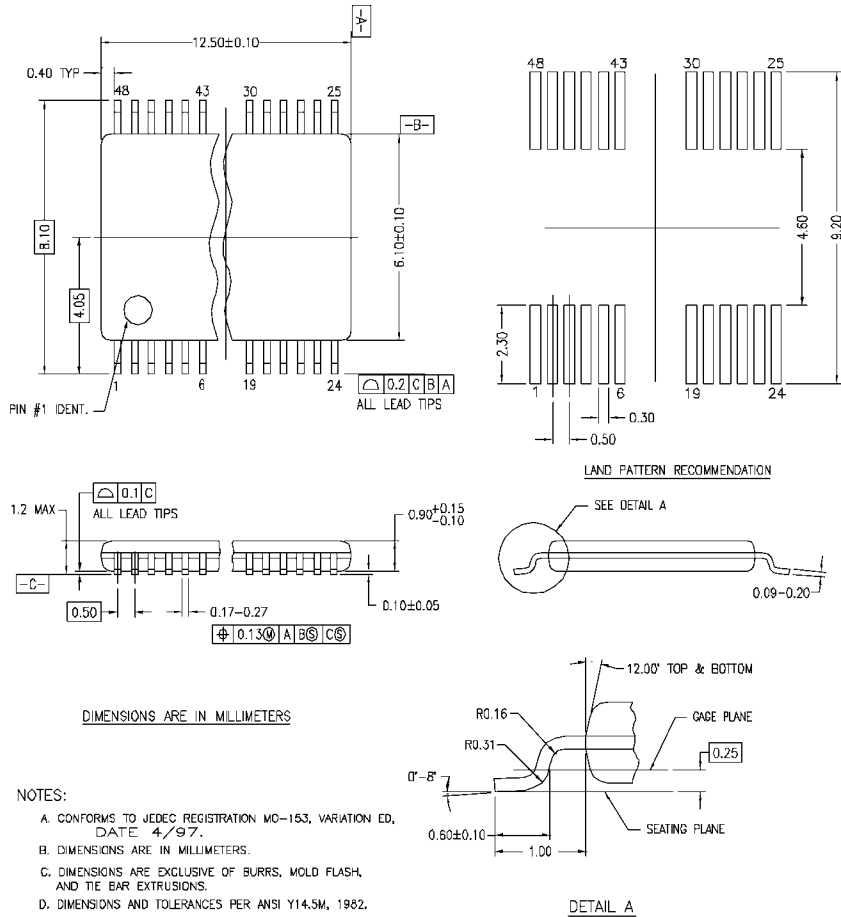

MTD48REV C

48-Lead Thin Shrink Small Outline Package (TSSOP), JEDEC MO-153, 6.1mm Wide Package Number MTD48

Fairchild does not assume any responsibility for use of any circuitry described, no circuit patent licenses are implied and Fairchild reserves the right at any time without notice to change said circuitry and specifications.

LIFE SUPPORT POLICY

FAIRCHILD'S PRODUCTS ARE NOT AUTHORIZED FOR USE AS CRITICAL COMPONENTS IN LIFE SUPPORT DEVICES OR SYSTEMS WITHOUT THE EXPRESS WRITTEN APPROVAL OF THE PRESIDENT OF FAIRCHILD SEMICONDUCTOR CORPORATION. As used herein:

- Life support devices or systems are devices or systems which, (a) are intended for surgical implant into the body, or (b) support or sustain life, and (c) whose failure to perform when properly used in accordance with instructions for use provided in the labeling, can be reasonably expected to result in a significant injury to the user.
- A critical component in any component of a life support device or system whose failure to perform can be reasonably expected to cause the failure of the life support device or system, or to affect its safety or effectiveness.

www.fairchildsemi.com

ON Semiconductor and  are trademarks of Semiconductor Components Industries, LLC dba ON Semiconductor or its subsidiaries in the United States and/or other countries. ON Semiconductor owns the rights to a number of patents, trademarks, copyrights, trade secrets, and other intellectual property. A listing of ON Semiconductor's product/patent coverage may be accessed at www.onsemi.com/site/pdf/Patent-Marking.pdf. ON Semiconductor reserves the right to make changes without further notice to any products herein. ON Semiconductor makes no warranty, representation or guarantee regarding the suitability of its products for any particular purpose, nor does ON Semiconductor assume any liability arising out of the application or use of any product or circuit, and specifically disclaims any and all liability, including without limitation special, consequential or incidental damages. Buyer is responsible for its products and applications using ON Semiconductor products, including compliance with all laws, regulations and safety requirements or standards, regardless of any support or applications information provided by ON Semiconductor. "Typical" parameters which may be provided in ON Semiconductor data sheets and/or specifications can and do vary in different applications and actual performance may vary over time. All operating parameters, including "Typicals" must be validated for each customer application by customer's technical experts. ON Semiconductor does not convey any license under its patent rights nor the rights of others. ON Semiconductor products are not designed, intended, or authorized for use as a critical component in life support systems or any FDA Class 3 medical devices or medical devices with a same or similar classification in a foreign jurisdiction or any devices intended for implantation in the human body. Should Buyer purchase or use ON Semiconductor products for any such unintended or unauthorized application, Buyer shall indemnify and hold ON Semiconductor and its officers, employees, subsidiaries, affiliates, and distributors harmless against all claims, costs, damages, and expenses, and reasonable attorney fees arising out of, directly or indirectly, any claim of personal injury or death associated with such unintended or unauthorized use, even if such claim alleges that ON Semiconductor was negligent regarding the design or manufacture of the part. ON Semiconductor is an Equal Opportunity/Affirmative Action Employer. This literature is subject to all applicable copyright laws and is not for resale in any manner.

PUBLICATION ORDERING INFORMATION

LITERATURE FULFILLMENT:



Literature Distribution Center for ON Semiconductor
19521 E. 32nd Pkwy, Aurora, Colorado 80011 USA
Phone: 303-675-2175 or 800-344-3860 Toll Free USA/Canada
Fax: 303-675-2176 or 800-344-3867 Toll Free USA/Canada
Email: orderlit@onsemi.com

N. American Technical Support: 800-282-9855 Toll Free
USA/Canada
Europe, Middle East and Africa Technical Support:
Phone: 421 33 790 2910
Japan Customer Focus Center
Phone: 81-3-5817-1050

ON Semiconductor Website: www.onsemi.com
Order Literature: <http://www.onsemi.com/orderlit>
For additional information, please contact your local
Sales Representative

Looking for pricing, stock, or lifecycle information?

Click below to explore more details on WIN SOURCE:

-  [View 74LVTH16373MEAX on WIN SOURCE](#)
-  [Fairchild/ON Semiconductor Information](#)

Optimize Your Supply Chain with WIN SOURCE Solutions

-  Global Sourcing Solution
-  Obsolete Management
-  Cost Control Management
-  Shortage Management
-  Alternative Solution
-  Excess Inventory Management