



**THE DATASHEET OF  
74LVC8T245PW,118**



# 74LVC8T245; 74LVCH8T245

8-bit dual supply translating transceiver; 3-state

Rev. 3 — 12 December 2011

Product data sheet

## 1. General description

The 74LVC8T245; 74LVCH8T245 are 8-bit dual supply translating transceivers with 3-state outputs that enable bidirectional level translation. They feature two data input-output ports (pins An and Bn), a direction control input (DIR), an output enable input ( $\overline{OE}$ ) and dual supply pins ( $V_{CC(A)}$  and  $V_{CC(B)}$ ). Both  $V_{CC(A)}$  and  $V_{CC(B)}$  can be supplied at any voltage between 1.2 V and 5.5 V making the device suitable for translating between any of the low voltage nodes (1.2 V, 1.5 V, 1.8 V, 2.5 V, 3.3 V and 5.0 V). Pins An,  $\overline{OE}$  and DIR are referenced to  $V_{CC(A)}$  and pins Bn are referenced to  $V_{CC(B)}$ . A HIGH on DIR allows transmission from An to Bn and a LOW on DIR allows transmission from Bn to An. The output enable input ( $\overline{OE}$ ) can be used to disable the outputs so the buses are effectively isolated.

The devices are fully specified for partial power-down applications using  $I_{OFF}$ . The  $I_{OFF}$  circuitry disables the output, preventing any damaging backflow current through the device when it is powered down. In suspend mode when either  $V_{CC(A)}$  or  $V_{CC(B)}$  are at GND level, both A port and B port are in the high-impedance OFF-state.

Active bus hold circuitry in the 74LVCH8T245 holds unused or floating data inputs at a valid logic level.

## 2. Features and benefits

- Wide supply voltage range:
  - ◆  $V_{CC(A)}$ : 1.2 V to 5.5 V
  - ◆  $V_{CC(B)}$ : 1.2 V to 5.5 V
- High noise immunity
- Complies with JEDEC standards:
  - ◆ JESD8-7 (1.2 V to 1.95 V)
  - ◆ JESD8-5 (1.8 V to 2.7 V)
  - ◆ JESD8C (2.7 V to 3.6 V)
  - ◆ JESD36 (4.5 V to 5.5 V)
- ESD protection:
  - ◆ HBM JESD22-A114F Class 3A exceeds 4000 V
  - ◆ MM JESD22-A115-B exceeds 200 V
  - ◆ CDM JESD22-C101E exceeds 1000 V
- Maximum data rates:
  - ◆ 420 Mbps (3.3 V to 5.0 V translation)
  - ◆ 210 Mbps (translate to 3.3 V)
  - ◆ 140 Mbps (translate to 2.5 V)
  - ◆ 75 Mbps (translate to 1.8 V)

- ◆ 60 Mbps (translate to 1.5 V)
- Suspend mode
- Latch-up performance exceeds 100 mA per JESD 78B Class II
- $\pm 24$  mA output drive ( $V_{CC} = 3.0$  V)
- Inputs accept voltages up to 5.5 V
- Low power consumption: 30  $\mu$ A maximum  $I_{CC}$
- $I_{OFF}$  circuitry provides partial Power-down mode operation
- Multiple package options
- Specified from  $-40$  °C to  $+85$  °C and  $-40$  °C to  $+125$  °C

### 3. Ordering information

Table 1. Ordering information

Type number	Package			Version
	Temperature range	Name	Description	
74LVC8T245PW 74LVCH8T245PW	$-40$ °C to $+125$ °C	TSSOP24	plastic thin shrink small outline package; 24 leads; body width 4.4 mm	SOT355-1
74LVC8T245BQ 74LVCH8T245BQ	$-40$ °C to $+125$ °C	DHVQFN24	plastic dual in-line compatible thermal enhanced very thin quad flat package; no leads; 24 terminals; body $3.5 \times 5.5 \times 0.85$ mm	SOT815-1

### 4. Functional diagram

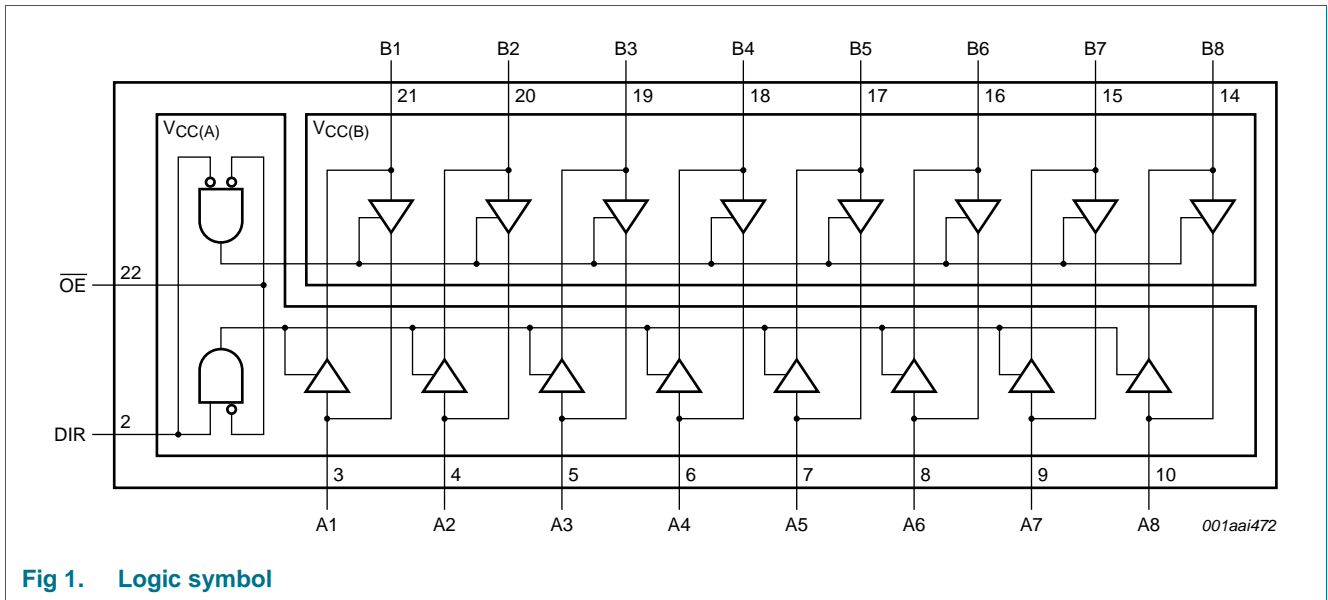

Fig 1. Logic symbol

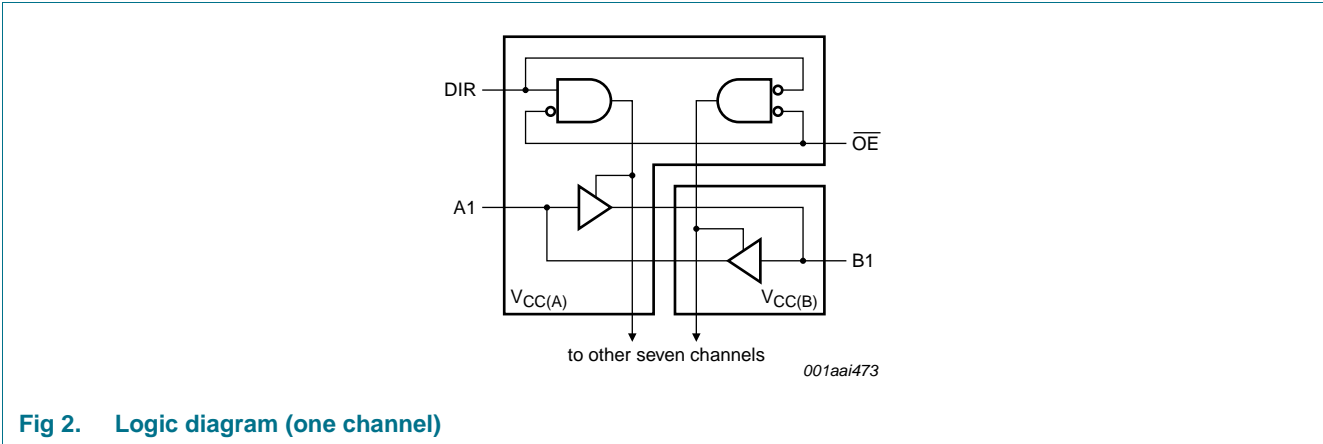

Fig 2. Logic diagram (one channel)

## 5. Pinning information

### 5.1 Pinning

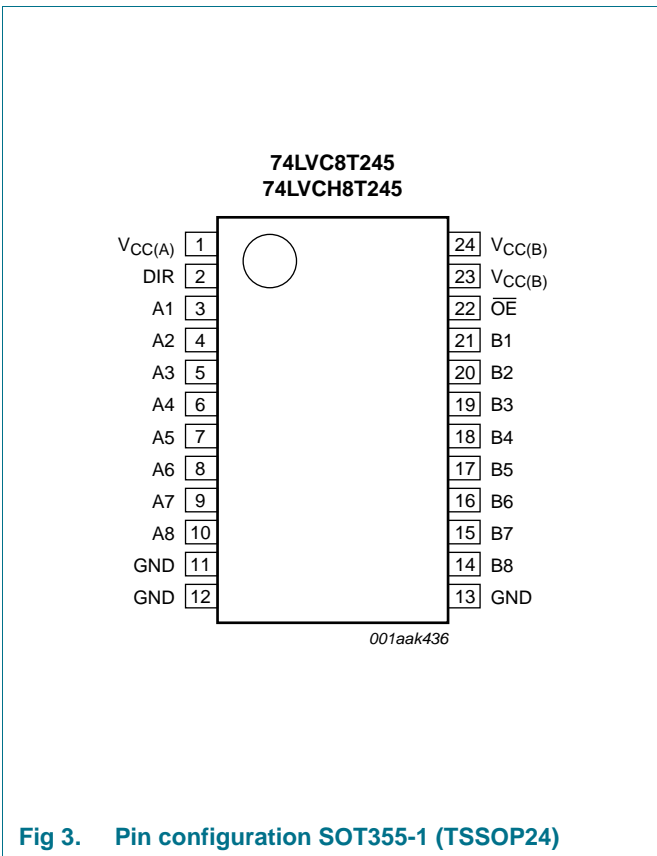

Fig 3. Pin configuration SOT355-1 (TSSOP24)

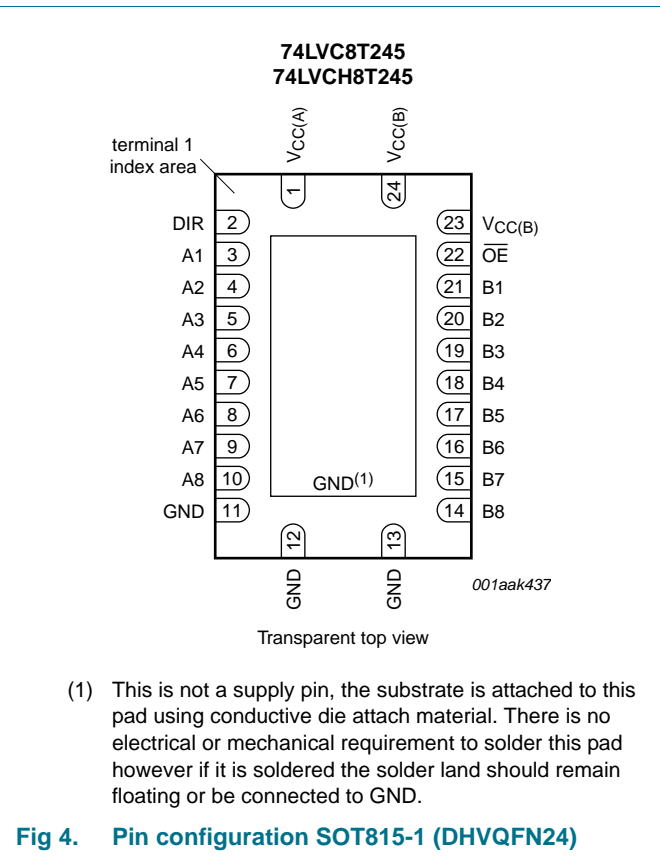

Fig 4. Pin configuration SOT815-1 (DHVQFN24)

## 5.2 Pin description

**Table 2.** Pin description

Symbol	Pin	Description
$V_{CC(A)}$	1	supply voltage A (An inputs/outputs, $\overline{OE}$ and DIR inputs are referenced to $V_{CC(A)}$ )
DIR	2	direction control
A1 to A8	3, 4, 5, 6, 7, 8, 9, 10	data input or output
GND <sup>[1]</sup>	11	ground (0 V)
GND <sup>[1]</sup>	12	ground (0 V)
GND <sup>[1]</sup>	13	ground (0 V)
B1 to B8	21, 20, 19, 18, 17, 16, 15, 14	data input or output
$\overline{OE}$	22	output enable input (active LOW)
$V_{CC(B)}$	23	supply voltage B (Bn inputs/outputs are referenced to $V_{CC(B)}$ )
$V_{CC(B)}$	24	supply voltage B (Bn inputs/outputs are referenced to $V_{CC(B)}$ )

[1] All GND pins must be connected to ground (0 V).

## 6. Functional description

**Table 3.** Function table<sup>[1]</sup>

Supply voltage	Input		Input/output <sup>[3]</sup>	
	$\overline{OE}$ <sup>[2]</sup>	DIR <sup>[2]</sup>	An <sup>[2]</sup>	Bn <sup>[2]</sup>
$V_{CC(A)}, V_{CC(B)}$				
1.2 V to 5.5 V	L	L	An = Bn	input
1.2 V to 5.5 V	L	H	input	Bn = An
1.2 V to 5.5 V	H	X	Z	Z
GND <sup>[3]</sup>	X	X	Z	Z

[1] H = HIGH voltage level; L = LOW voltage level; X = don't care; Z = high-impedance OFF-state.

[2] The An inputs/outputs, DIR and  $\overline{OE}$  input circuit is referenced to  $V_{CC(A)}$ ; The Bn inputs/outputs circuit is referenced to  $V_{CC(B)}$ .

[3] If at least one of  $V_{CC(A)}$  or  $V_{CC(B)}$  is at GND level, the device goes into suspend mode.

## 7. Limiting values

**Table 4.** Limiting values

In accordance with the Absolute Maximum Rating System (IEC 60134). Voltages are referenced to GND (ground = 0 V).

Symbol	Parameter	Conditions	Min	Max	Unit
$V_{CC(A)}$	supply voltage A		-0.5	+6.5	V
$V_{CC(B)}$	supply voltage B		-0.5	+6.5	V
$I_{IK}$	input clamping current	$V_I < 0$ V	-50	-	mA
$V_I$	input voltage		<sup>[1]</sup> -0.5	+6.5	V
$I_{OK}$	output clamping current	$V_O < 0$ V	-50	-	mA
$V_O$	output voltage	Active mode	<sup>[1][2][3]</sup> -0.5	$V_{CCO} + 0.5$	V
		Suspend or 3-state mode	<sup>[1]</sup> -0.5	+6.5	V
$I_O$	output current	$V_O = 0$ V to $V_{CCO}$	<sup>[2]</sup> -	±50	mA
$I_{CC}$	supply current	$I_{CC(A)}$ or $I_{CC(B)}$ ; per $V_{CC}$ pin	-	100	mA

**Table 4.** Limiting values ...continued

In accordance with the Absolute Maximum Rating System (IEC 60134). Voltages are referenced to GND (ground = 0 V).

Symbol	Parameter	Conditions	Min	Max	Unit
$I_{\text{GND}}$	ground current	per GND pin	-100	-	mA
$T_{\text{stg}}$	storage temperature		-65	+150	°C
$P_{\text{tot}}$	total power dissipation	$T_{\text{amb}} = -40\text{ °C to }+125\text{ °C}$	[4] -	500	mW

[1] The minimum input voltage ratings and output voltage ratings may be exceeded if the input and output current ratings are observed.

[2]  $V_{\text{CCO}}$  is the supply voltage associated with the output port.

[3]  $V_{\text{CCO}} + 0.5\text{ V}$  should not exceed 6.5 V.

[4] For TSSOP24 package:  $P_{\text{tot}}$  derates linearly at 5.5 mW/K above 60 °C.  
For DHVQFN24 package:  $P_{\text{tot}}$  derates linearly at 4.5 mW/K above 60 °C.

## 8. Recommended operating conditions

**Table 5.** Recommended operating conditions

Symbol	Parameter	Conditions	Min	Max	Unit
$V_{\text{CC(A)}}$	supply voltage A		1.2	5.5	V
$V_{\text{CC(B)}}$	supply voltage B		1.2	5.5	V
$V_{\text{I}}$	input voltage		0	5.5	V
$V_{\text{O}}$	output voltage	Active mode	[1] 0	$V_{\text{CCO}}$	V
		Suspend or 3-state mode	0	5.5	V
$T_{\text{amb}}$	ambient temperature		-40	+125	°C
$\Delta t/\Delta V$	input transition rise and fall rate	$V_{\text{CCI}} = 1.2\text{ V}$	[2] -	20	ns/V
		$V_{\text{CCI}} = 1.4\text{ V to }1.95\text{ V}$	-	20	ns/V
		$V_{\text{CCI}} = 2.3\text{ V to }2.7\text{ V}$	-	20	ns/V
		$V_{\text{CCI}} = 3\text{ V to }3.6\text{ V}$	-	10	ns/V
		$V_{\text{CCI}} = 4.5\text{ V to }5.5\text{ V}$	-	5	ns/V

[1]  $V_{\text{CCO}}$  is the supply voltage associated with the output port.

[2]  $V_{\text{CCI}}$  is the supply voltage associated with the input port.

## 9. Static characteristics

**Table 6.** Typical static characteristics at  $T_{\text{amb}} = 25\text{ °C}$ 

At recommended operating conditions; voltages are referenced to GND (ground = 0 V).

Symbol	Parameter	Conditions	Min	Typ	Max	Unit
$V_{\text{OH}}$	HIGH-level output voltage	$V_{\text{I}} = V_{\text{IH}}$ or $V_{\text{IL}}$	[1]			
		$I_{\text{O}} = -3\text{ mA}; V_{\text{CCO}} = 1.2\text{ V}$	-	1.09	-	V
$V_{\text{OL}}$	LOW-level output voltage	$V_{\text{I}} = V_{\text{IH}}$ or $V_{\text{IL}}$				
		$I_{\text{O}} = 3\text{ mA}; V_{\text{CCO}} = 1.2\text{ V}$	[1] -	0.07	-	V
$I_{\text{I}}$	input leakage current	DIR, $\overline{\text{OE}}$ input; $V_{\text{I}} = 0\text{ V to }5.5\text{ V}; V_{\text{CCI}} = 1.2\text{ V to }5.5\text{ V}$	[2] -	-	$\pm 1$	$\mu\text{A}$
$I_{\text{BHL}}$	bus hold LOW current	A or B port; $V_{\text{I}} = 0.42\text{ V}; V_{\text{CCI}} = 1.2\text{ V}$	[2] -	19	-	$\mu\text{A}$
$I_{\text{BHH}}$	bus hold HIGH current	A or B port; $V_{\text{I}} = 0.78\text{ V}; V_{\text{CCI}} = 1.2\text{ V}$	[2] -	-19	-	$\mu\text{A}$

**Table 6.** Typical static characteristics at  $T_{amb} = 25\text{ °C}$  ...continued

At recommended operating conditions; voltages are referenced to GND (ground = 0 V).

Symbol	Parameter	Conditions	Min	Typ	Max	Unit
$I_{BHLO}$	bus hold LOW overdrive current	A or B port; $V_{CCI} = 1.2\text{ V}$	[2][3]	-	19	$\mu\text{A}$
$I_{BHHO}$	bus hold HIGH overdrive current	A or B port; $V_{CCI} = 1.2\text{ V}$	[2][3]	-	-19	$\mu\text{A}$
$I_{OZ}$	OFF-state output current	A or B port; $V_O = 0\text{ V}$ or $V_{CCO}$ ; $V_{CCO} = 1.2\text{ V}$ to $5.5\text{ V}$	[1]	-	$\pm 1$	$\mu\text{A}$
		suspend mode A port; $V_O = 0\text{ V}$ or $V_{CCO}$ ; $V_{CC(A)} = 5.5\text{ V}$ ; $V_{CC(B)} = 0\text{ V}$	[1]	-	$\pm 1$	$\mu\text{A}$
		suspend mode B port; $V_O = 0\text{ V}$ or $V_{CCO}$ ; $V_{CC(A)} = 0\text{ V}$ ; $V_{CC(B)} = 5.5\text{ V}$	[1]	-	$\pm 1$	$\mu\text{A}$
$I_{OFF}$	power-off leakage current	A port; $V_I$ or $V_O = 0\text{ V}$ to $5.5\text{ V}$ ; $V_{CC(A)} = 0\text{ V}$ ; $V_{CC(B)} = 1.2\text{ V}$ to $5.5\text{ V}$	-	-	$\pm 1$	$\mu\text{A}$
		B port; $V_I$ or $V_O = 0\text{ V}$ to $5.5\text{ V}$ ; $V_{CC(B)} = 0\text{ V}$ ; $V_{CC(A)} = 1.2\text{ V}$ to $5.5\text{ V}$	-	-	$\pm 1$	$\mu\text{A}$
$C_I$	input capacitance	DIR, $\overline{OE}$ input; $V_I = 0\text{ V}$ or $3.3\text{ V}$ ; $V_{CC(A)} = 3.3\text{ V}$	-	3	-	pF
$C_{I/O}$	input/output capacitance	A and B port; $V_O = 3.3\text{ V}$ or $0\text{ V}$ ; $V_{CC(A)} = V_{CC(B)} = 3.3\text{ V}$	-	6.5	-	pF

[1]  $V_{CCO}$  is the supply voltage associated with the output port.[2]  $V_{CCI}$  is the supply voltage associated with the data input port.[3] To guarantee the node switches, an external driver must source/sink at least  $I_{BHLO} / I_{BHHO}$  when the input is in the range  $V_{IL}$  to  $V_{IH}$ .**Table 7.** Static characteristics

At recommended operating conditions; voltages are referenced to GND (ground = 0 V).

Symbol	Parameter	Conditions	-40 °C to +85 °C		-40 °C to +125 °C		Unit
			Min	Max	Min	Max	
$V_{IH}$	HIGH-level input voltage	data input [1]					
		$V_{CCI} = 1.2\text{ V}$	$0.8V_{CCI}$	-	$0.8V_{CCI}$	-	V
		$V_{CCI} = 1.4\text{ V}$ to $1.95\text{ V}$	$0.65V_{CCI}$	-	$0.65V_{CCI}$	-	V
		$V_{CCI} = 2.3\text{ V}$ to $2.7\text{ V}$	1.7	-	1.7	-	V
		$V_{CCI} = 3.0\text{ V}$ to $3.6\text{ V}$	2.0	-	2.0	-	V
		$V_{CCI} = 4.5\text{ V}$ to $5.5\text{ V}$	$0.7V_{CCI}$	-	$0.7V_{CCI}$	-	V
		DIR, $\overline{OE}$ input					
		$V_{CCI} = 1.2\text{ V}$	$0.8V_{CC(A)}$	-	$0.8V_{CC(A)}$	-	V
		$V_{CCI} = 1.4\text{ V}$ to $1.95\text{ V}$	$0.65V_{CC(A)}$	-	$0.65V_{CC(A)}$	-	V
		$V_{CCI} = 2.3\text{ V}$ to $2.7\text{ V}$	1.7	-	1.7	-	V
		$V_{CCI} = 3.0\text{ V}$ to $3.6\text{ V}$	2.0	-	2.0	-	V
		$V_{CCI} = 4.5\text{ V}$ to $5.5\text{ V}$	$0.7V_{CC(A)}$	-	$0.7V_{CC(A)}$	-	V

**Table 7. Static characteristics ...continued**

At recommended operating conditions; voltages are referenced to GND (ground = 0 V).

Symbol	Parameter	Conditions	-40 °C to +85 °C		-40 °C to +125 °C		Unit
			Min	Max	Min	Max	
V <sub>IL</sub>	LOW-level input voltage	data input <a href="#">[1]</a>					
		V <sub>CCI</sub> = 1.2 V	-	0.2V <sub>CCI</sub>	-	0.2V <sub>CCI</sub>	V
		V <sub>CCI</sub> = 1.4 V to 1.95 V	-	0.35V <sub>CCI</sub>	-	0.35V <sub>CCI</sub>	V
		V <sub>CCI</sub> = 2.3 V to 2.7 V	-	0.7	-	0.7	V
		V <sub>CCI</sub> = 3.0 V to 3.6 V	-	0.8	-	0.8	V
		V <sub>CCI</sub> = 4.5 V to 5.5 V	-	0.3V <sub>CCI</sub>	-	0.3V <sub>CCI</sub>	V
		DIR, $\overline{\text{OE}}$ input					
		V <sub>CCI</sub> = 1.2 V	-	0.2V <sub>CC(A)</sub>	-	0.2V <sub>CC(A)</sub>	V
		V <sub>CCI</sub> = 1.4 V to 1.95 V	-	0.35V <sub>CC(A)</sub>	-	0.35V <sub>CC(A)</sub>	V
		V <sub>CCI</sub> = 2.3 V to 2.7 V	-	0.7	-	0.7	V
		V <sub>CCI</sub> = 3.0 V to 3.6 V	-	0.8	-	0.8	V
		V <sub>CCI</sub> = 4.5 V to 5.5 V	-	0.3V <sub>CC(A)</sub>	-	0.3V <sub>CC(A)</sub>	V
V <sub>OH</sub>	HIGH-level output voltage	V <sub>I</sub> = V <sub>IH</sub>					
		I <sub>O</sub> = -100 μA; V <sub>CCO</sub> = 1.2 V to 4.5 V <a href="#">[2]</a>	V <sub>CCO</sub> - 0.1	-	V <sub>CCO</sub> - 0.1	-	V
		I <sub>O</sub> = -6 mA; V <sub>CCO</sub> = 1.4 V	1.0	-	1.0	-	V
		I <sub>O</sub> = -8 mA; V <sub>CCO</sub> = 1.65 V	1.2	-	1.2	-	V
		I <sub>O</sub> = -12 mA; V <sub>CCO</sub> = 2.3 V	1.9	-	1.9	-	V
		I <sub>O</sub> = -24 mA; V <sub>CCO</sub> = 3.0 V	2.4	-	2.4	-	V
V <sub>OL</sub>	LOW-level output voltage	V <sub>I</sub> = V <sub>IL</sub> <a href="#">[2]</a>					
		I <sub>O</sub> = 100 μA; V <sub>CCO</sub> = 1.2 V to 4.5 V	-	0.1	-	0.1	V
		I <sub>O</sub> = 6 mA; V <sub>CCO</sub> = 1.4 V	-	0.3	-	0.3	V
		I <sub>O</sub> = 8 mA; V <sub>CCO</sub> = 1.65 V	-	0.45	-	0.45	V
		I <sub>O</sub> = 12 mA; V <sub>CCO</sub> = 2.3 V	-	0.3	-	0.3	V
		I <sub>O</sub> = 24 mA; V <sub>CCO</sub> = 3.0 V	-	0.55	-	0.55	V
I <sub>I</sub>	input leakage current	DIR, $\overline{\text{OE}}$ input; V <sub>I</sub> = 0 V to 5.5 V; V <sub>CCI</sub> = 1.2 V to 5.5 V	-	±2	-	±10	μA
I <sub>BHL</sub>	bus hold LOW current	A or B port <a href="#">[1]</a>					
		V <sub>I</sub> = 0.49 V; V <sub>CCI</sub> = 1.4 V	15	-	10	-	μA
		V <sub>I</sub> = 0.58 V; V <sub>CCI</sub> = 1.65 V	25	-	20	-	μA
		V <sub>I</sub> = 0.70 V; V <sub>CCI</sub> = 2.3 V	45	-	45	-	μA
		V <sub>I</sub> = 0.80 V; V <sub>CCI</sub> = 3.0 V	100	-	80	-	μA
		V <sub>I</sub> = 1.35 V; V <sub>CCI</sub> = 4.5 V	100	-	100	-	μA

**Table 7. Static characteristics ...continued**

At recommended operating conditions; voltages are referenced to GND (ground = 0 V).

Symbol	Parameter	Conditions	-40 °C to +85 °C		-40 °C to +125 °C		Unit
			Min	Max	Min	Max	
I <sub>BHH</sub>	bus hold HIGH current	A or B port <a href="#">[1]</a>					
		V <sub>I</sub> = 0.91 V; V <sub>CCI</sub> = 1.4 V	-15	-	-10	-	μA
		V <sub>I</sub> = 1.07 V; V <sub>CCI</sub> = 1.65 V	-25	-	-20	-	μA
		V <sub>I</sub> = 1.70 V; V <sub>CCI</sub> = 2.3 V	-45	-	-45	-	μA
		V <sub>I</sub> = 2.00 V; V <sub>CCI</sub> = 3.0 V	-100	-	-80	-	μA
		V <sub>I</sub> = 3.15 V; V <sub>CCI</sub> = 4.5 V	-100	-	-100	-	μA
I <sub>BHLO</sub>	bus hold LOW overdrive current	A or B port <a href="#">[1][3]</a>					
		V <sub>CCI</sub> = 1.6 V	125	-	125	-	μA
		V <sub>CCI</sub> = 1.95 V	200	-	200	-	μA
		V <sub>CCI</sub> = 2.7 V	300	-	300	-	μA
		V <sub>CCI</sub> = 3.6 V	500	-	500	-	μA
		V <sub>CCI</sub> = 5.5 V	900	-	900	-	μA
I <sub>BHHO</sub>	bus hold HIGH overdrive current	A or B port <a href="#">[1][3]</a>					
		V <sub>CCI</sub> = 1.6 V	-125	-	-125	-	μA
		V <sub>CCI</sub> = 1.95 V	-200	-	-200	-	μA
		V <sub>CCI</sub> = 2.7 V	-300	-	-300	-	μA
		V <sub>CCI</sub> = 3.6 V	-500	-	-500	-	μA
		V <sub>CCI</sub> = 5.5 V	-900	-	-900	-	μA
I <sub>OZ</sub>	OFF-state output current	A or B port; V <sub>O</sub> = 0 V or V <sub>CCO</sub> ; V <sub>CCO</sub> = 1.2 V to 5.5 V <a href="#">[2]</a>	-	±2	-	±10	μA
		suspend mode A port; V <sub>O</sub> = 0 V or V <sub>CCO</sub> ; V <sub>CC(A)</sub> = 5.5 V; V <sub>CC(B)</sub> = 0 V <a href="#">[2]</a>	-	±2	-	±10	μA
		suspend mode B port; V <sub>O</sub> = 0 V or V <sub>CCO</sub> ; V <sub>CC(A)</sub> = 0 V; V <sub>CC(B)</sub> = 5.5 V <a href="#">[2]</a>	-	±2	-	±10	μA
I <sub>OFF</sub>	power-off leakage current	A port; V <sub>I</sub> or V <sub>O</sub> = 0 V to 5.5 V; V <sub>CC(A)</sub> = 0 V; V <sub>CC(B)</sub> = 1.2 V to 5.5 V	-	±2	-	±10	μA
		B port; V <sub>I</sub> or V <sub>O</sub> = 0 V to 5.5 V; V <sub>CC(B)</sub> = 0 V; V <sub>CC(A)</sub> = 1.2 V to 5.5 V	-	±2	-	±10	μA

**Table 7. Static characteristics ...continued**

At recommended operating conditions; voltages are referenced to GND (ground = 0 V).

Symbol	Parameter	Conditions	-40 °C to +85 °C		-40 °C to +125 °C		Unit
			Min	Max	Min	Max	
$I_{CC}$	supply current	A port; $V_I = 0$ V or $V_{CCI}$ ; $I_O = 0$ A <a href="#">[1]</a>					
		$V_{CC(A)}, V_{CC(B)} = 1.2$ V to 5.5 V	-	15	-	20	$\mu$ A
		$V_{CC(A)} = 5.5$ V; $V_{CC(B)} = 0$ V	-	15	-	20	$\mu$ A
		$V_{CC(A)} = 0$ V; $V_{CC(B)} = 5.5$ V	-2	-	-4	-	$\mu$ A
		B port; $V_I = 0$ V or $V_{CCI}$ ; $I_O = 0$ A					
		$V_{CC(A)}, V_{CC(B)} = 1.2$ V to 5.5 V	-	15	-	20	$\mu$ A
		$V_{CC(B)} = 0$ V; $V_{CC(A)} = 5.5$ V	-2	-	-4	-	$\mu$ A
		$V_{CC(B)} = 5.5$ V; $V_{CC(A)} = 0$ V	-	15	-	20	$\mu$ A
$\Delta I_{CC}$	additional supply current	A plus B port ( $I_{CC(A)} + I_{CC(B)}$ ); $I_O = 0$ A; $V_I = 0$ V or $V_{CCI}$					
		$V_{CC(A)}, V_{CC(B)} = 1.2$ V to 5.5 V	-	25	-	30	$\mu$ A
		per input; $V_{CC(A)}, V_{CC(B)} = 3.0$ V to 5.5 V					
		DIR and OE input; DIR or OE input at $V_{CC(A)} - 0.6$ V; A port at $V_{CC(A)}$ or GND; B port = open	-	50	-	75	$\mu$ A
	A port; A port at $V_{CC(A)} - 0.6$ V; DIR at $V_{CC(A)}$ ; B port = open	<a href="#">[4]</a>	-	50	-	75	$\mu$ A
	B port; B port at $V_{CC(B)} - 0.6$ V; DIR at GND; A port = open	<a href="#">[4]</a>	-	50	-	75	$\mu$ A

[1]  $V_{CCI}$  is the supply voltage associated with the data input port.[2]  $V_{CCO}$  is the supply voltage associated with the output port.[3] To guarantee the node switches, an external driver must source/sink at least  $I_{BHLO} / I_{BHHO}$  when the input is in the range  $V_{IL}$  to  $V_{IH}$ .

[4] For non bus hold parts only (74LVC8T245).

## 10. Dynamic characteristics

**Table 8. Typical dynamic characteristics at  $V_{CC(A)} = 1.2\text{ V}$  and  $T_{amb} = 25\text{ °C}$ [1]**

Voltages are referenced to GND (ground = 0 V); for test circuit see [Figure 7](#); for waveforms see [Figure 5](#) and [Figure 6](#).

Symbol	Parameter	Conditions	$V_{CC(B)}$						Unit
			1.2 V	1.5 V	1.8 V	2.5 V	3.3 V	5.0 V	
$t_{pd}$	propagation delay	An to Bn	11.0	8.5	7.4	6.2	5.7	5.4	ns
		Bn to An	11.0	10.0	9.5	9.1	8.9	8.9	ns
$t_{dis}$	disable time	$\overline{OE}$ to An	9.5	9.5	9.5	9.5	9.5	9.5	ns
		$\overline{OE}$ to Bn	10.2	8.2	7.8	6.7	7.3	6.4	ns
$t_{en}$	enable time	$\overline{OE}$ to An	13.5	13.5	13.5	13.5	13.5	13.5	ns
		$\overline{OE}$ to Bn	13.6	10.3	8.9	7.5	7.1	7.0	ns

[1]  $t_{pd}$  is the same as  $t_{PLH}$  and  $t_{PHL}$ ;  $t_{dis}$  is the same as  $t_{PLZ}$  and  $t_{PHZ}$ ;  $t_{en}$  is the same as  $t_{PZL}$  and  $t_{PZH}$ .

**Table 9. Typical dynamic characteristics at  $V_{CC(B)} = 1.2\text{ V}$  and  $T_{amb} = 25\text{ °C}$ [1]**

Voltages are referenced to GND (ground = 0 V); for test circuit see [Figure 7](#); for waveforms see [Figure 5](#) and [Figure 6](#).

Symbol	Parameter	Conditions	$V_{CC(A)}$						Unit
			1.2 V	1.5 V	1.8 V	2.5 V	3.3 V	5.0 V	
$t_{pd}$	propagation delay	An to Bn	11.0	10.0	9.5	9.1	8.9	8.8	ns
		Bn to An	11.0	8.5	7.3	6.2	5.7	5.4	ns
$t_{dis}$	disable time	$\overline{OE}$ to An	9.5	6.8	5.4	3.8	4.1	3.1	ns
		$\overline{OE}$ to Bn	10.2	9.1	8.6	8.1	7.8	7.8	ns
$t_{en}$	enable time	$\overline{OE}$ to An	13.5	9.0	6.9	4.8	3.8	3.2	ns
		$\overline{OE}$ to Bn	13.6	12.5	12.0	11.5	11.4	11.4	ns

[1]  $t_{pd}$  is the same as  $t_{PLH}$  and  $t_{PHL}$ ;  $t_{dis}$  is the same as  $t_{PLZ}$  and  $t_{PHZ}$ ;  $t_{en}$  is the same as  $t_{PZL}$  and  $t_{PZH}$ .

**Table 10. Typical power dissipation capacitance at  $V_{CC(A)} = V_{CC(B)}$  and  $T_{amb} = 25\text{ °C}$ [1][2]**

Voltages are referenced to GND (ground = 0 V).

Symbol	Parameter	Conditions	$V_{CC(A)}$ and $V_{CC(B)}$				Unit
			1.8 V	2.5 V	3.3 V	5.0 V	
$C_{PD}$	power dissipation capacitance	A port: (direction A to B); B port: (direction B to A)	1	1	1	2	pF
		A port: (direction B to A); B port: (direction A to B)	13	13	13	13	pF

[1]  $C_{PD}$  is used to determine the dynamic power dissipation ( $P_D$  in  $\mu\text{W}$ ).

$$P_D = C_{PD} \times V_{CC}^2 \times f_i \times N + \Sigma(C_L \times V_{CC}^2 \times f_o) \text{ where:}$$

$f_i$  = input frequency in MHz;

$f_o$  = output frequency in MHz;

$C_L$  = load capacitance in pF;

$V_{CC}$  = supply voltage in V;

$N$  = number of inputs switching;

$\Sigma(C_L \times V_{CC}^2 \times f_o)$  = sum of the outputs.

[2]  $f_i = 10\text{ MHz}$ ;  $V_i = \text{GND to } V_{CC}$ ;  $t_r = t_f = 1\text{ ns}$ ;  $C_L = 0\text{ pF}$ ;  $R_L = \infty\ \Omega$ .

**Table 11. Dynamic characteristics for temperature range  $-40\text{ }^{\circ}\text{C}$  to  $+85\text{ }^{\circ}\text{C}$ [1]**Voltages are referenced to GND (ground = 0 V); for test circuit see [Figure 7](#); for wave forms see [Figure 5](#) and [Figure 6](#).

Symbol	Parameter	Conditions	$V_{CC(B)}$										Unit
			$1.5\text{ V} \pm 0.1\text{ V}$		$1.8\text{ V} \pm 0.15\text{ V}$		$2.5\text{ V} \pm 0.2\text{ V}$		$3.3\text{ V} \pm 0.3\text{ V}$		$5.0\text{ V} \pm 0.5\text{ V}$		
			Min	Max	Min	Max	Min	Max	Min	Max	Min	Max	
<b><math>V_{CC(A)} = 1.5\text{ V} \pm 0.1\text{ V}</math></b>													
$t_{pd}$	propagation delay	An to Bn	1.7	27	1.7	23	1.3	18	1.0	15	0.8	13	ns
		Bn to An	0.9	27	0.9	25	0.8	23	0.7	23	0.7	22	ns
$t_{dis}$	disable time	$\overline{OE}$ to An	1.5	30	1.5	30	1.5	30	1.5	30	1.4	30	ns
		$\overline{OE}$ to Bn	2.4	34	2.4	33	1.9	15	1.7	14	1.3	12	ns
$t_{en}$	enable time	$\overline{OE}$ to An	0.4	34	0.4	34	0.4	34	0.4	34	0.4	34	ns
		$\overline{OE}$ to Bn	1.8	36	1.8	34	1.5	18	1.2	15	0.9	13	ns
<b><math>V_{CC(A)} = 1.8\text{ V} \pm 0.15\text{ V}</math></b>													
$t_{pd}$	propagation delay	An to Bn	1.7	25	1.7	21.9	1.3	9.2	1.0	7.4	0.8	7.1	ns
		Bn to An	0.9	23	0.9	23.8	0.8	23.6	0.7	23.4	0.7	23.4	ns
$t_{dis}$	disable time	$\overline{OE}$ to An	1.5	30	1.5	29.6	1.5	29.4	1.5	29.3	1.4	29.2	ns
		$\overline{OE}$ to Bn	2.4	33	2.4	32.2	1.9	13.1	1.7	12.0	1.3	10.3	ns
$t_{en}$	enable time	$\overline{OE}$ to An	0.4	24	0.4	24.0	0.4	23.8	0.4	23.7	0.4	23.7	ns
		$\overline{OE}$ to Bn	1.8	34	1.8	32.0	1.5	16.0	1.2	12.6	0.9	10.8	ns
<b><math>V_{CC(A)} = 2.5\text{ V} \pm 0.2\text{ V}</math></b>													
$t_{pd}$	propagation delay	An to Bn	1.5	23	1.5	21.4	1.2	9.0	0.8	6.2	0.6	4.8	ns
		Bn to An	1.2	18	1.2	9.3	1.0	9.1	1.0	8.9	0.9	8.8	ns
$t_{dis}$	disable time	$\overline{OE}$ to An	1.4	9.0	1.4	9.0	1.4	9.0	1.4	9.0	1.4	9.0	ns
		$\overline{OE}$ to Bn	2.3	31	2.3	29.6	1.8	11.0	1.7	9.3	0.9	6.9	ns
$t_{en}$	enable time	$\overline{OE}$ to An	1.0	10.9	1.0	10.9	1.0	10.9	1.0	10.9	1.0	10.9	ns
		$\overline{OE}$ to Bn	1.7	32	1.7	28.2	1.5	12.9	1.2	9.4	1.0	6.9	ns
<b><math>V_{CC(A)} = 3.3\text{ V} \pm 0.3\text{ V}</math></b>													
$t_{pd}$	propagation delay	An to Bn	1.5	23	1.5	21.2	1.1	8.8	0.8	6.3	0.5	4.4	ns
		Bn to An	0.8	15	0.8	7.2	0.8	6.2	0.7	6.1	0.6	6.0	ns
$t_{dis}$	disable time	$\overline{OE}$ to An	1.6	8.2	1.6	8.2	1.6	8.2	1.6	8.2	1.6	8.2	ns
		$\overline{OE}$ to Bn	2.1	30	2.1	29.0	1.7	10.3	1.5	8.6	0.8	6.3	ns
$t_{en}$	enable time	$\overline{OE}$ to An	0.8	8.1	0.8	8.1	0.8	8.1	0.8	8.1	0.8	8.1	ns
		$\overline{OE}$ to Bn	1.8	31	1.8	27.7	1.4	12.4	1.1	8.5	0.9	6.4	ns
<b><math>V_{CC(A)} = 5.0\text{ V} \pm 0.5\text{ V}</math></b>													
$t_{pd}$	propagation delay	An to Bn	1.5	22	1.5	21.4	1.0	8.8	0.7	6.0	0.4	4.2	ns
		Bn to An	0.7	13	0.7	7.0	0.4	4.8	0.3	4.5	0.3	4.3	ns
$t_{dis}$	disable time	$\overline{OE}$ to An	0.3	5.4	0.3	5.4	0.3	5.4	0.3	5.4	0.3	5.4	ns
		$\overline{OE}$ to Bn	2.0	30	2.0	28.7	1.6	9.7	1.4	8.0	0.7	5.7	ns
$t_{en}$	enable time	$\overline{OE}$ to An	0.7	6.4	0.7	6.4	0.7	6.4	0.7	6.4	0.7	6.4	ns
		$\overline{OE}$ to Bn	1.5	31	1.5	27.6	1.3	11.4	1.0	8.1	0.9	6.0	ns

[1]  $t_{pd}$  is the same as  $t_{PLH}$  and  $t_{PHL}$ ;  $t_{dis}$  is the same as  $t_{PLZ}$  and  $t_{PHZ}$ ;  $t_{en}$  is the same as  $t_{PZL}$  and  $t_{PZH}$ .

**Table 12. Dynamic characteristics for temperature range  $-40\text{ }^{\circ}\text{C}$  to  $+125\text{ }^{\circ}\text{C}$ [1]**Voltages are referenced to GND (ground = 0 V); for test circuit see [Figure 7](#); for wave forms see [Figure 5](#) and [Figure 6](#).

Symbol	Parameter	Conditions	$V_{CC(B)}$										Unit
			$1.5\text{ V} \pm 0.1\text{ V}$		$1.8\text{ V} \pm 0.15\text{ V}$		$2.5\text{ V} \pm 0.2\text{ V}$		$3.3\text{ V} \pm 0.3\text{ V}$		$5.0\text{ V} \pm 0.5\text{ V}$		
			Min	Max	Min	Max	Min	Max	Min	Max	Min	Max	
<b><math>V_{CC(A)} = 1.5\text{ V} \pm 0.1\text{ V}</math></b>													
$t_{pd}$	propagation delay	An to Bn	1.7	32	1.7	27	1.3	21	1.0	18	0.8	16	ns
		Bn to An	0.9	32	0.9	30	0.8	28	0.7	28	0.7	26	ns
$t_{dis}$	disable time	$\overline{OE}$ to An	1.5	34	1.5	34	1.5	34	1.5	34	1.4	34	ns
		$\overline{OE}$ to Bn	2.4	41	2.4	40	1.9	18	1.7	17	1.3	15	ns
$t_{en}$	enable time	$\overline{OE}$ to An	0.4	40	0.4	40	0.4	40	0.4	40	0.4	40	ns
		$\overline{OE}$ to Bn	1.8	43	1.8	41	1.5	22	1.2	18	0.9	16	ns
<b><math>V_{CC(A)} = 1.8\text{ V} \pm 0.15\text{ V}</math></b>													
$t_{pd}$	propagation delay	An to Bn	1.7	30	1.7	25.9	1.3	13.2	1.0	11.4	0.8	11.1	ns
		Bn to An	0.9	27	0.9	28.8	0.8	27.6	0.7	27.4	0.7	27.4	ns
$t_{dis}$	disable time	$\overline{OE}$ to An	1.5	34	1.5	33.6	1.5	33.4	1.5	33.3	1.4	33.2	ns
		$\overline{OE}$ to Bn	2.4	40	2.4	36.2	1.9	17.1	1.7	16.0	1.3	14.3	ns
$t_{en}$	enable time	$\overline{OE}$ to An	0.4	28	0.4	28	0.4	27.8	0.4	27.7	0.4	27.7	ns
		$\overline{OE}$ to Bn	1.8	41	1.8	40	1.5	20	1.2	16.6	0.9	14.8	ns
<b><math>V_{CC(A)} = 2.5\text{ V} \pm 0.2\text{ V}</math></b>													
$t_{pd}$	propagation delay	An to Bn	1.5	28	1.5	25.4	1.2	13	0.8	10.2	0.6	8.8	ns
		Bn to An	1.2	23	1.2	13.3	1.0	13.1	1.0	12.9	0.9	12.8	ns
$t_{dis}$	disable time	$\overline{OE}$ to An	1.4	13	1.4	13	1.4	13	1.4	13	1.4	13	ns
		$\overline{OE}$ to Bn	2.3	37	2.3	33.6	1.8	15	1.7	14.3	0.9	10.9	ns
$t_{en}$	enable time	$\overline{OE}$ to An	1.0	17.2	1.0	17.2	1.0	17.3	1.0	17.2	1.0	17.3	ns
		$\overline{OE}$ to Bn	1.7	38	1.7	32.2	1.5	18.1	1.2	14.1	1.0	11.2	ns
<b><math>V_{CC(A)} = 3.3\text{ V} \pm 0.3\text{ V}</math></b>													
$t_{pd}$	propagation delay	An to Bn	1.5	28	1.5	25.2	1.1	12.8	0.8	10.3	0.5	10.4	ns
		Bn to An	0.8	18	0.8	11.2	0.8	10.2	0.7	10.1	0.6	10	ns
$t_{dis}$	disable time	$\overline{OE}$ to An	1.6	12.2	1.6	12.2	1.6	12.2	1.6	12.2	1.6	12.2	ns
		$\overline{OE}$ to Bn	2.1	36	2.1	33	1.7	14.3	1.5	12.6	0.8	10.3	ns
$t_{en}$	enable time	$\overline{OE}$ to An	0.8	14.1	0.8	14.1	0.8	13.6	0.8	13.2	0.8	13.6	ns
		$\overline{OE}$ to Bn	1.8	37	1.8	31.7	1.4	18.4	1.1	12.9	0.9	10.9	ns
<b><math>V_{CC(A)} = 5.0\text{ V} \pm 0.5\text{ V}</math></b>													
$t_{pd}$	propagation delay	An to Bn	1.5	26	1.5	25.4	1.0	12.8	0.7	10	0.4	8.2	ns
		Bn to An	0.7	16	0.7	11	0.4	8.8	0.3	8.5	0.3	8.3	ns
$t_{dis}$	disable time	$\overline{OE}$ to An	0.3	9.4	0.3	9.4	0.3	9.4	0.3	9.4	0.3	9.4	ns
		$\overline{OE}$ to Bn	2.0	36	2.0	32.7	1.6	13.7	1.4	12	0.7	9.7	ns
$t_{en}$	enable time	$\overline{OE}$ to An	0.7	10.9	0.7	10.9	0.7	10.9	0.7	10.9	0.7	10.9	ns
		$\overline{OE}$ to Bn	1.5	37	1.5	31.6	1.3	18.4	1.0	13.7	0.9	10.7	ns

[1]  $t_{pd}$  is the same as  $t_{PLH}$  and  $t_{PHL}$ ;  $t_{dis}$  is the same as  $t_{PLZ}$  and  $t_{PHZ}$ ;  $t_{en}$  is the same as  $t_{PZL}$  and  $t_{PZH}$ .

## 11. Waveforms

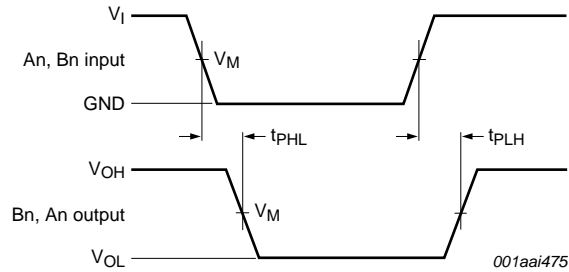

Measurement points are given in [Table 13](#).

$V_{OL}$  and  $V_{OH}$  are typical output voltage levels that occur with the output load.

**Fig 5. The data input (An, Bn) to output (Bn, An) propagation delay times**

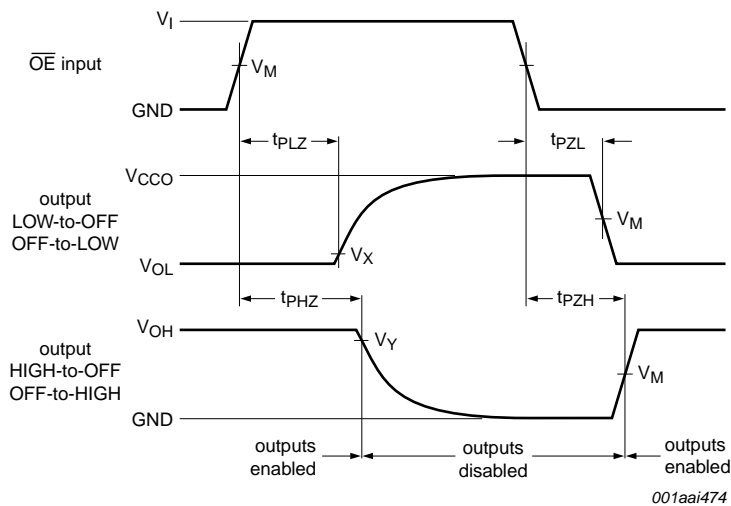

Measurement points are given in [Table 13](#).

$V_{OL}$  and  $V_{OH}$  are typical output voltage levels that occur with the output load.

**Fig 6. Enable and disable times**

**Table 13. Measurement points**

Supply voltage	Input <sup>[1]</sup>	Output <sup>[2]</sup>		
$V_{CC(A)}, V_{CC(B)}$	$V_M$	$V_M$	$V_X$	$V_Y$
1.2 V to 1.6 V	$0.5V_{CCI}$	$0.5V_{CCO}$	$V_{OL} + 0.1\text{ V}$	$V_{OH} - 0.1\text{ V}$
1.65 V to 2.7 V	$0.5V_{CCI}$	$0.5V_{CCO}$	$V_{OL} + 0.15\text{ V}$	$V_{OH} - 0.15\text{ V}$
3.0 V to 5.5 V	$0.5V_{CCI}$	$0.5V_{CCO}$	$V_{OL} + 0.3\text{ V}$	$V_{OH} - 0.3\text{ V}$

[1]  $V_{CCI}$  is the supply voltage associated with the data input port.

[2]  $V_{CCO}$  is the supply voltage associated with the output port.

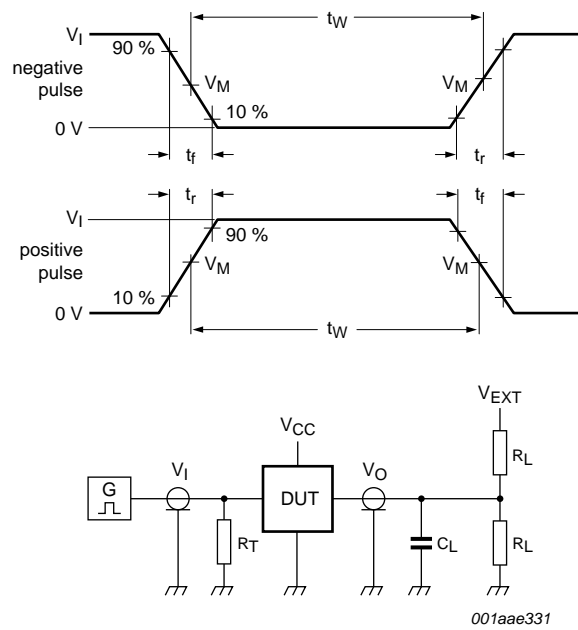

Test data is given in [Table 14](#).

$R_L$  = Load resistance.

$C_L$  = Load capacitance including jig and probe capacitance.

$R_T$  = Termination resistance.

$V_{EXT}$  = External voltage for measuring switching times.

**Fig 7. Load circuitry for switching times**

**Table 14. Test data**

Supply voltage	Input		Load		$V_{EXT}$		
$V_{CC(A)}, V_{CC(B)}$	$V_I$ <sup>[1]</sup>	$\Delta t/\Delta V$ <sup>[2]</sup>	$C_L$	$R_L$	$t_{PLH}, t_{PHL}$	$t_{PZH}, t_{PHZ}$	$t_{PZL}, t_{PLZ}$ <sup>[3]</sup>
1.2 V to 5.5 V	$V_{CCI}$	$\leq 1.0 \text{ ns/V}$	15 pF	2 k $\Omega$	open	GND	$2V_{CCO}$

[1]  $V_{CCI}$  is the supply voltage associated with the data input port.

[2]  $dV/dt \geq 1.0 \text{ V/ns}$ .

[3]  $V_{CCO}$  is the supply voltage associated with the output port.

## 12. Typical propagation delay characteristics

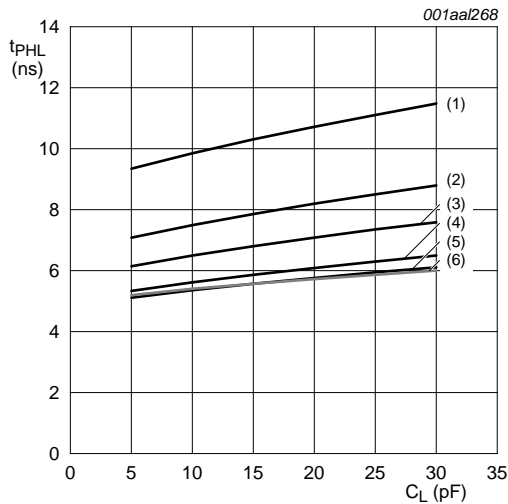

a. HIGH to LOW propagation delay (A to B)

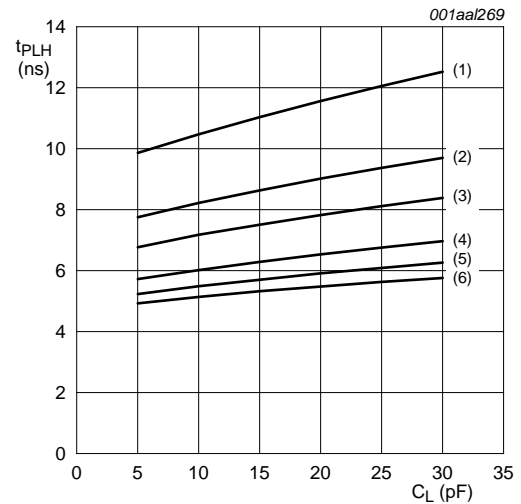

b. LOW to HIGH propagation delay (A to B)

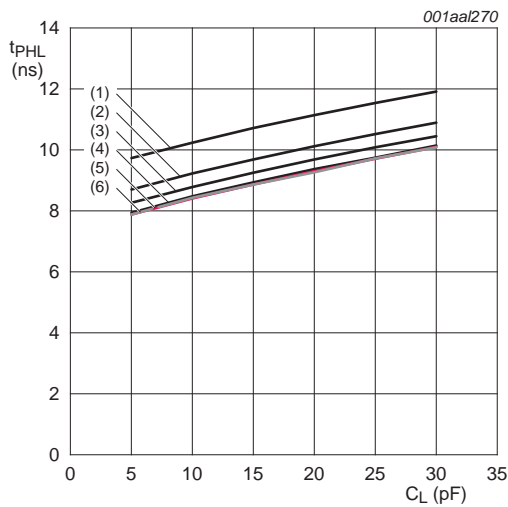

c. HIGH to LOW propagation delay (B to A)

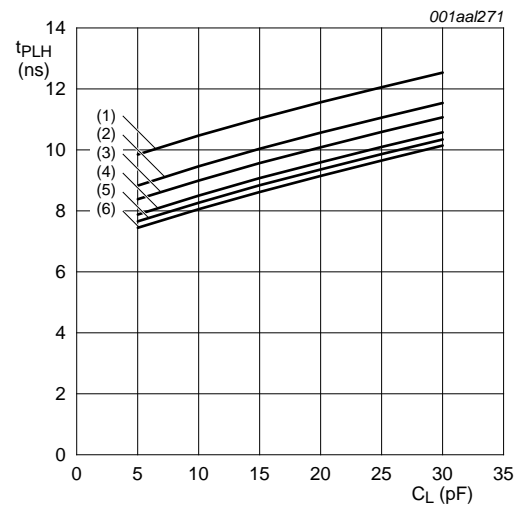

d. LOW to HIGH propagation delay (B to A)

- (1)  $V_{CC(B)} = 1.2\text{ V}$ .
- (2)  $V_{CC(B)} = 1.5\text{ V}$ .
- (3)  $V_{CC(B)} = 1.8\text{ V}$ .
- (4)  $V_{CC(B)} = 2.5\text{ V}$ .
- (5)  $V_{CC(B)} = 3.3\text{ V}$ .
- (6)  $V_{CC(B)} = 5.0\text{ V}$ .

**Fig 8.** Typical propagation delay versus load capacitance;  $T_{amb} = 25\text{ }^{\circ}\text{C}$ ;  $V_{CC(A)} = 1.2\text{ V}$

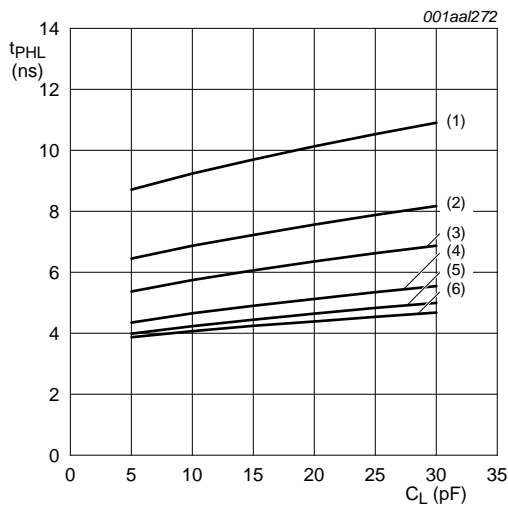

a. HIGH to LOW propagation delay (A to B)

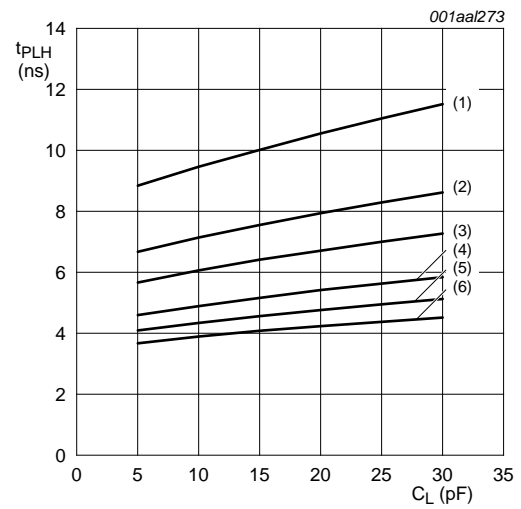

b. LOW to HIGH propagation delay (A to B)

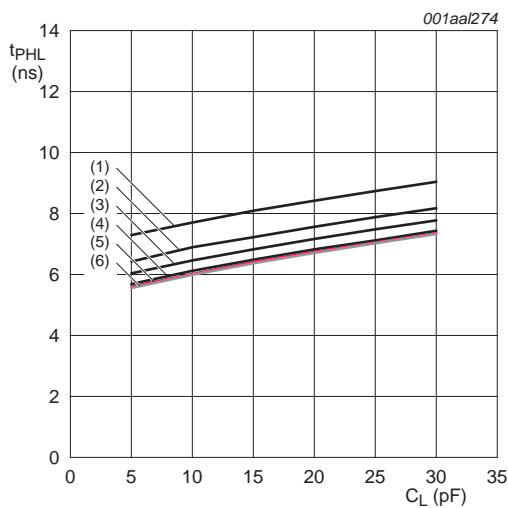

c. HIGH to LOW propagation delay (B to A)

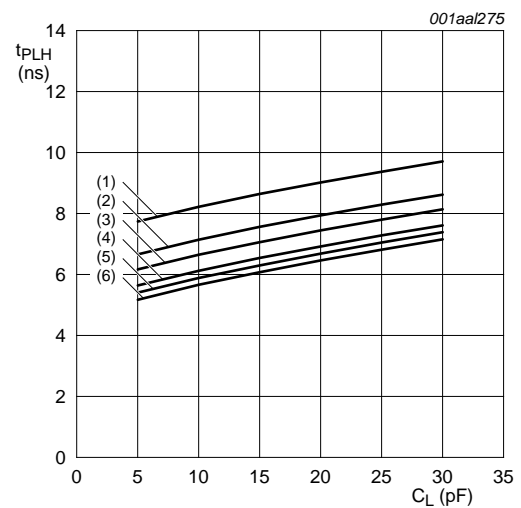

d. LOW to HIGH propagation delay (B to A)

- (1)  $V_{CC(B)} = 1.2\text{ V}$ .
- (2)  $V_{CC(B)} = 1.5\text{ V}$ .
- (3)  $V_{CC(B)} = 1.8\text{ V}$ .
- (4)  $V_{CC(B)} = 2.5\text{ V}$ .
- (5)  $V_{CC(B)} = 3.3\text{ V}$ .
- (6)  $V_{CC(B)} = 5.0\text{ V}$ .

**Fig 9. Typical propagation delay versus load capacitance;  $T_{amb} = 25\text{ }^\circ\text{C}$ ;  $V_{CC(A)} = 1.5\text{ V}$**

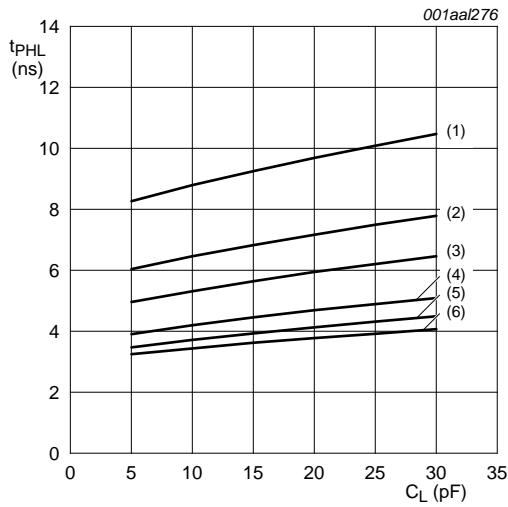

a. HIGH to LOW propagation delay (A to B)

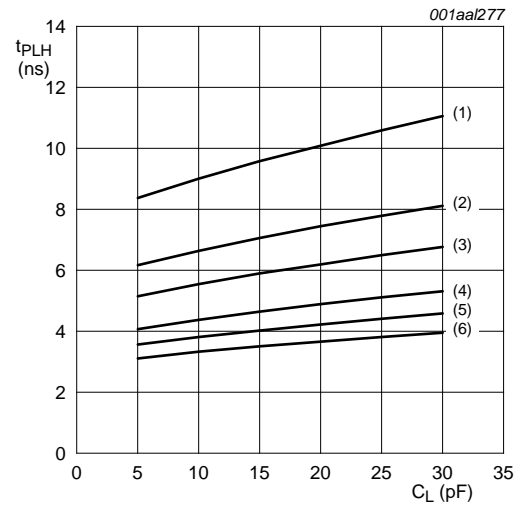

b. LOW to HIGH propagation delay (A to B)

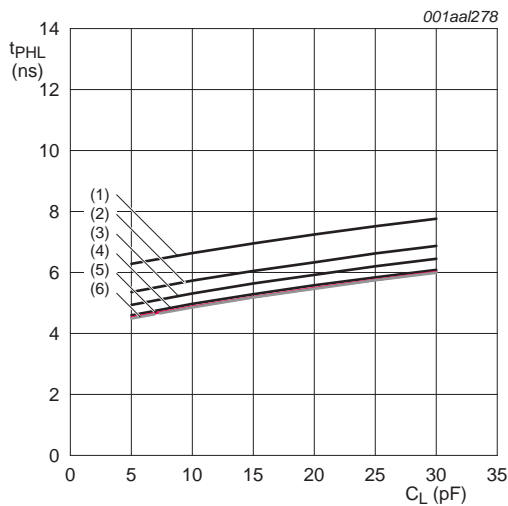

c. HIGH to LOW propagation delay (B to A)

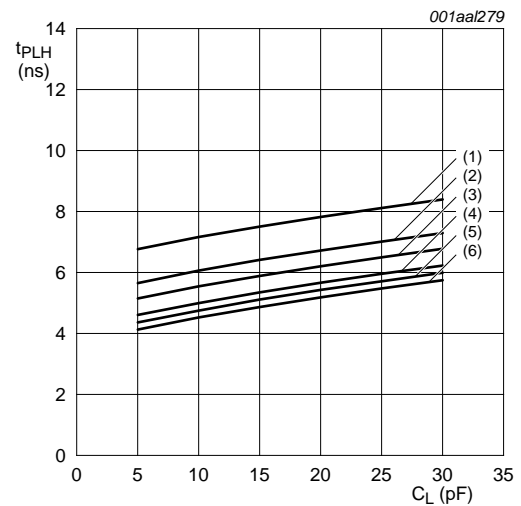

d. LOW to HIGH propagation delay (B to A)

- (1)  $V_{CC(B)} = 1.2\text{ V}$ .
- (2)  $V_{CC(B)} = 1.5\text{ V}$ .
- (3)  $V_{CC(B)} = 1.8\text{ V}$ .
- (4)  $V_{CC(B)} = 2.5\text{ V}$ .
- (5)  $V_{CC(B)} = 3.3\text{ V}$ .
- (6)  $V_{CC(B)} = 5.0\text{ V}$ .

**Fig 10. Typical propagation delay versus load capacitance;  $T_{amb} = 25\text{ }^{\circ}\text{C}$ ;  $V_{CC(A)} = 1.8\text{ V}$**

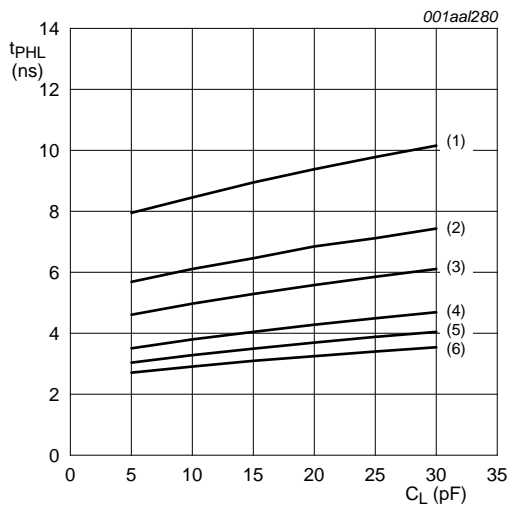

a. HIGH to LOW propagation delay (A to B)

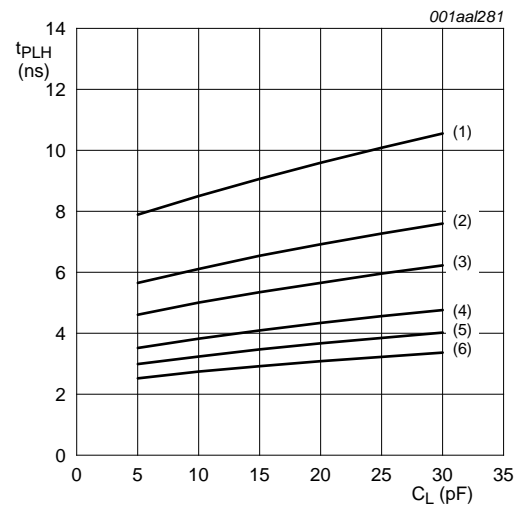

b. LOW to HIGH propagation delay (A to B)

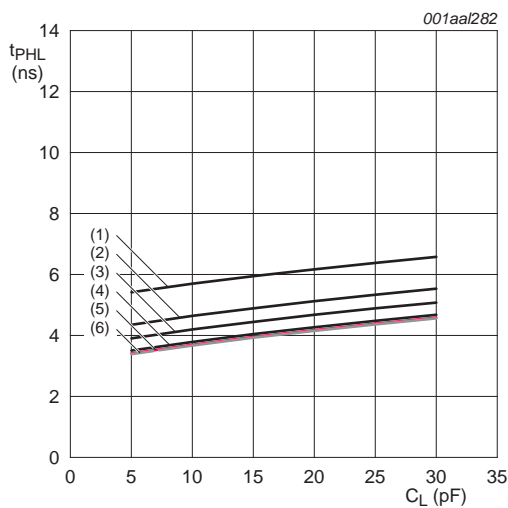

c. HIGH to LOW propagation delay (B to A)

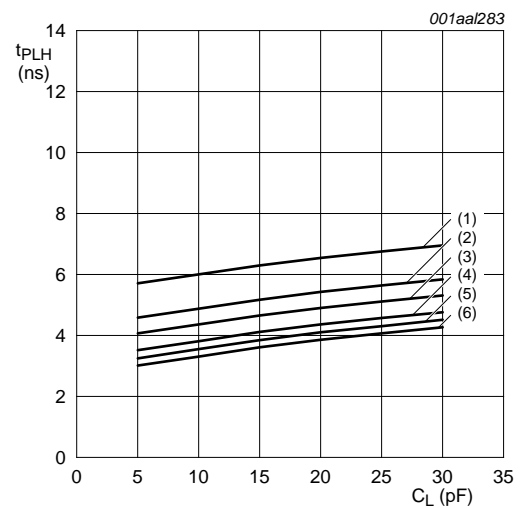

d. LOW to HIGH propagation delay (B to A)

- (1)  $V_{CC(B)} = 1.2\text{ V}$ .
- (2)  $V_{CC(B)} = 1.5\text{ V}$ .
- (3)  $V_{CC(B)} = 1.8\text{ V}$ .
- (4)  $V_{CC(B)} = 2.5\text{ V}$ .
- (5)  $V_{CC(B)} = 3.3\text{ V}$ .
- (6)  $V_{CC(B)} = 5.0\text{ V}$ .

**Fig 11. Typical propagation delay versus load capacitance;  $T_{amb} = 25\text{ }^\circ\text{C}$ ;  $V_{CC(A)} = 2.5\text{ V}$**

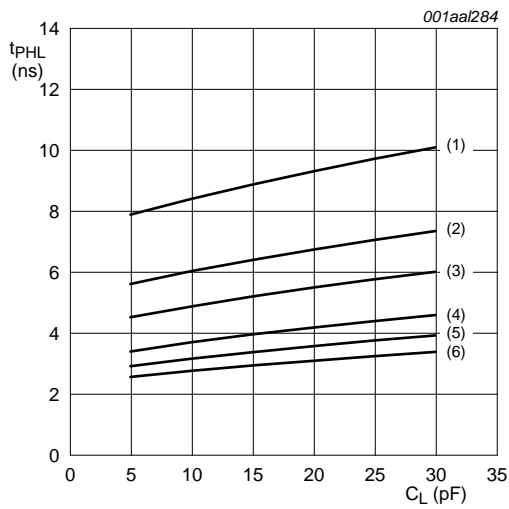

a. HIGH to LOW propagation delay (A to B)

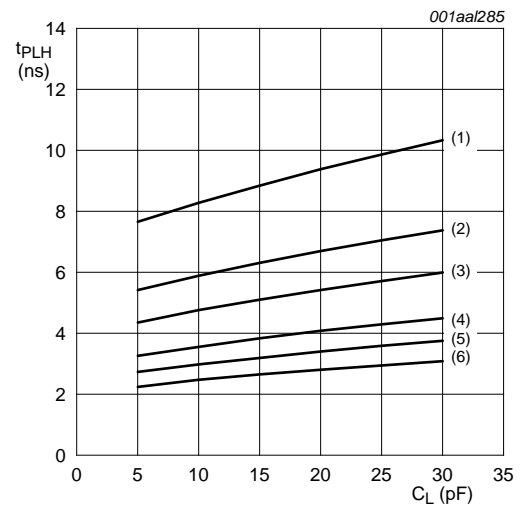

b. LOW to HIGH propagation delay (A to B)

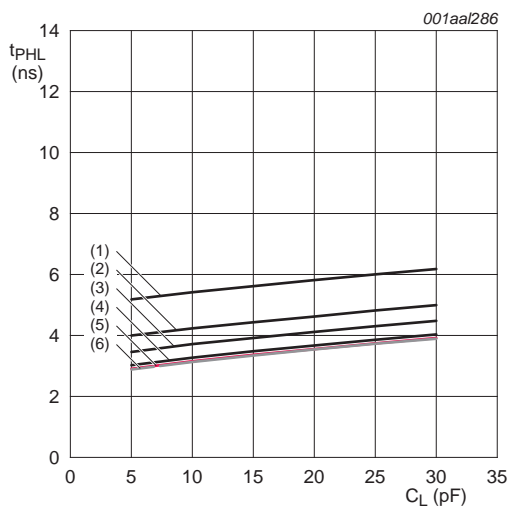

c. HIGH to LOW propagation delay (B to A)

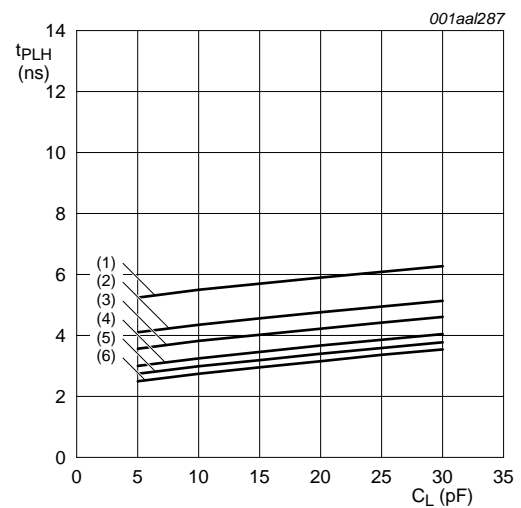

d. LOW to HIGH propagation delay (B to A)

- (1)  $V_{CC(B)} = 1.2\text{ V}$ .
- (2)  $V_{CC(B)} = 1.5\text{ V}$ .
- (3)  $V_{CC(B)} = 1.8\text{ V}$ .
- (4)  $V_{CC(B)} = 2.5\text{ V}$ .
- (5)  $V_{CC(B)} = 3.3\text{ V}$ .
- (6)  $V_{CC(B)} = 5.0\text{ V}$ .

**Fig 12. Typical propagation delay versus load capacitance;  $T_{amb} = 25\text{ }^\circ\text{C}$ ;  $V_{CC(A)} = 3.3\text{ V}$**

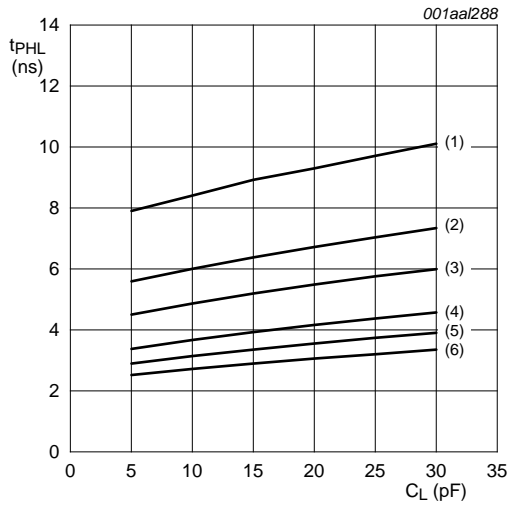

a. HIGH to LOW propagation delay (A to B)

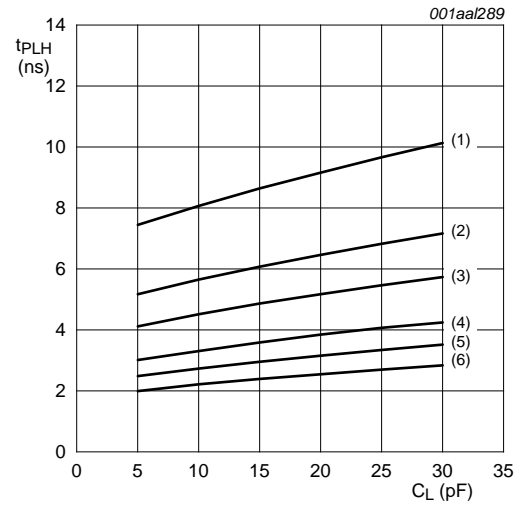

b. LOW to HIGH propagation delay (A to B)

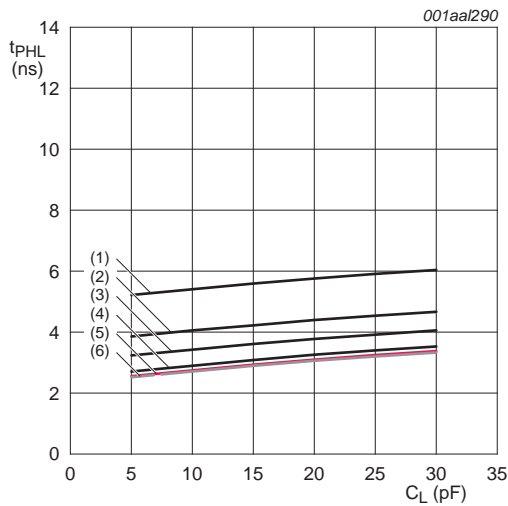

c. HIGH to LOW propagation delay (B to A)

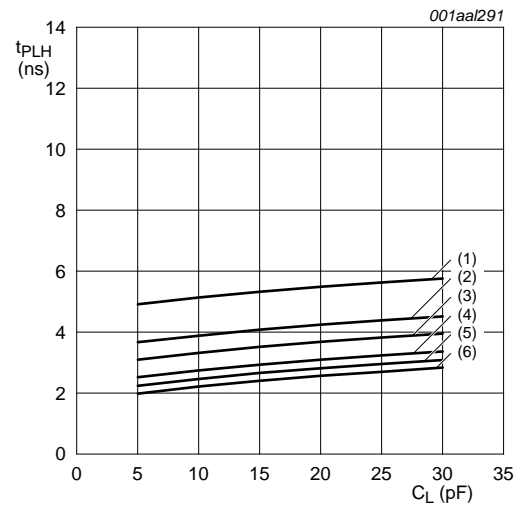

d. LOW to HIGH propagation delay (B to A)

- (1)  $V_{CC(B)} = 1.2\text{ V}$ .
- (2)  $V_{CC(B)} = 1.5\text{ V}$ .
- (3)  $V_{CC(B)} = 1.8\text{ V}$ .
- (4)  $V_{CC(B)} = 2.5\text{ V}$ .
- (5)  $V_{CC(B)} = 3.3\text{ V}$ .
- (6)  $V_{CC(B)} = 5.0\text{ V}$ .

**Fig 13. Typical propagation delay versus load capacitance;  $T_{amb} = 25\text{ }^\circ\text{C}$ ;  $V_{CC(A)} = 5\text{ V}$**

## 13. Application information

### 13.1 Unidirectional logic level-shifting application

The circuit given in [Figure 14](#) is an example of the 74LVC8T245; 74LVCH8T245 being used in an unidirectional logic level-shifting application.

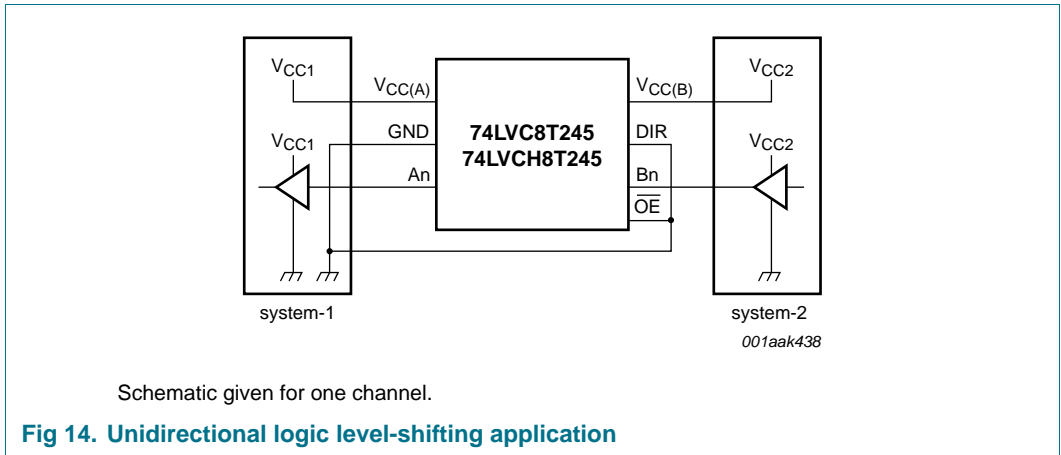
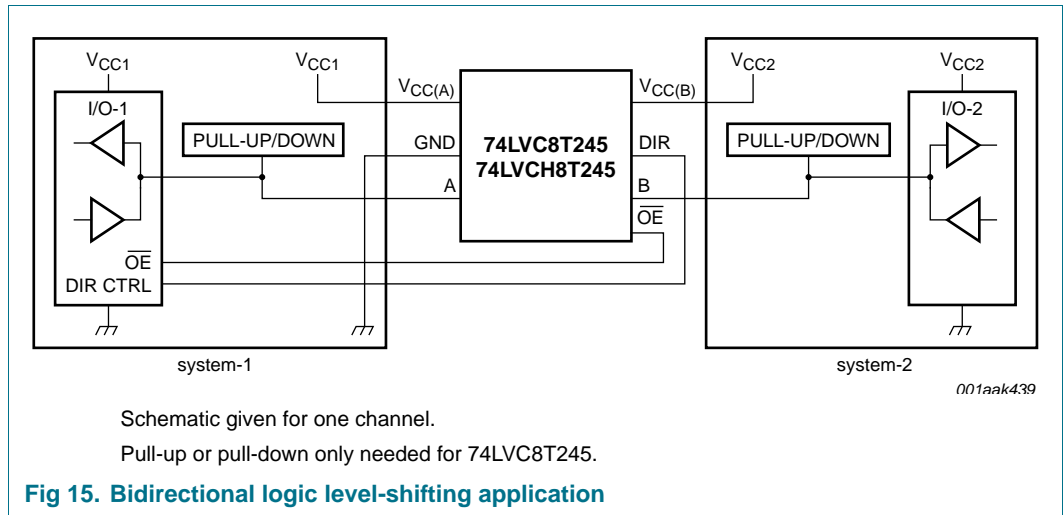

**Table 15. Description unidirectional logic level-shifting application**

Name	Function	Description
$V_{CC(A)}$	$V_{CC1}$	supply voltage of system-1 (1.2 V to 5.5 V)
GND	GND	device GND
A	OUT	output level depends on $V_{CC1}$ voltage
B	IN	input threshold value depends on $V_{CC2}$ voltage
DIR	DIR	the GND (LOW level) determines B port to A port direction
$V_{CC(B)}$	$V_{CC2}$	supply voltage of system-2 (1.2 V to 5.5 V)
$\overline{OE}$	$\overline{OE}$	The GND (LOW level) enables the output ports

## 13.2 Bidirectional logic level-shifting application

Figure 15 shows the 74LVC8T245; 74LVCH8T245 being used in a bidirectional logic level-shifting application.



**Fig 15. Bidirectional logic level-shifting application**

Table 16 gives a sequence that will illustrate data transmission from system-1 to system-2 and then from system-2 to system-1.

**Table 16. Description bidirectional logic level-shifting application**

State	DIR CTRL	OE	I/O-1	I/O-2	Description
1	H	L	output	input	system-1 data to system-2
2	H	H	Z	Z	system-2 is getting ready to send data to system-1. I/O-1 and I/O-2 are disabled. The bus-line state depends on bus hold.
3	L	H	Z	Z	DIR bit is set LOW. I/O-1 and I/O-2 still are disabled. The bus-line state depends on bus hold.
4	L	L	input	output	system-2 data to system-1

[1] H = HIGH voltage level; L = LOW voltage level; Z = high-impedance OFF-state.

## 13.3 Power-up considerations

The device is designed such that no special power-up sequence is required other than GND being applied first.

**Table 17. Typical total supply current ( $I_{CC(A)} + I_{CC(B)}$ )**

$V_{CC(A)}$	$V_{CC(B)}$					Unit
	0 V	1.8 V	2.5 V	3.3 V	5.0 V	
0 V	0	< 1	< 1	< 1	< 1	$\mu\text{A}$
1.8 V	< 1	< 2	< 2	< 2	2	$\mu\text{A}$
2.5 V	< 1	< 2	< 2	< 2	< 2	$\mu\text{A}$
3.3 V	< 1	< 2	< 2	< 2	< 2	$\mu\text{A}$
5.0 V	< 1	2	< 2	< 2	< 2	$\mu\text{A}$

## 14. Package outline

TSSOP24: plastic thin shrink small outline package; 24 leads; body width 4.4 mm

SOT355-1

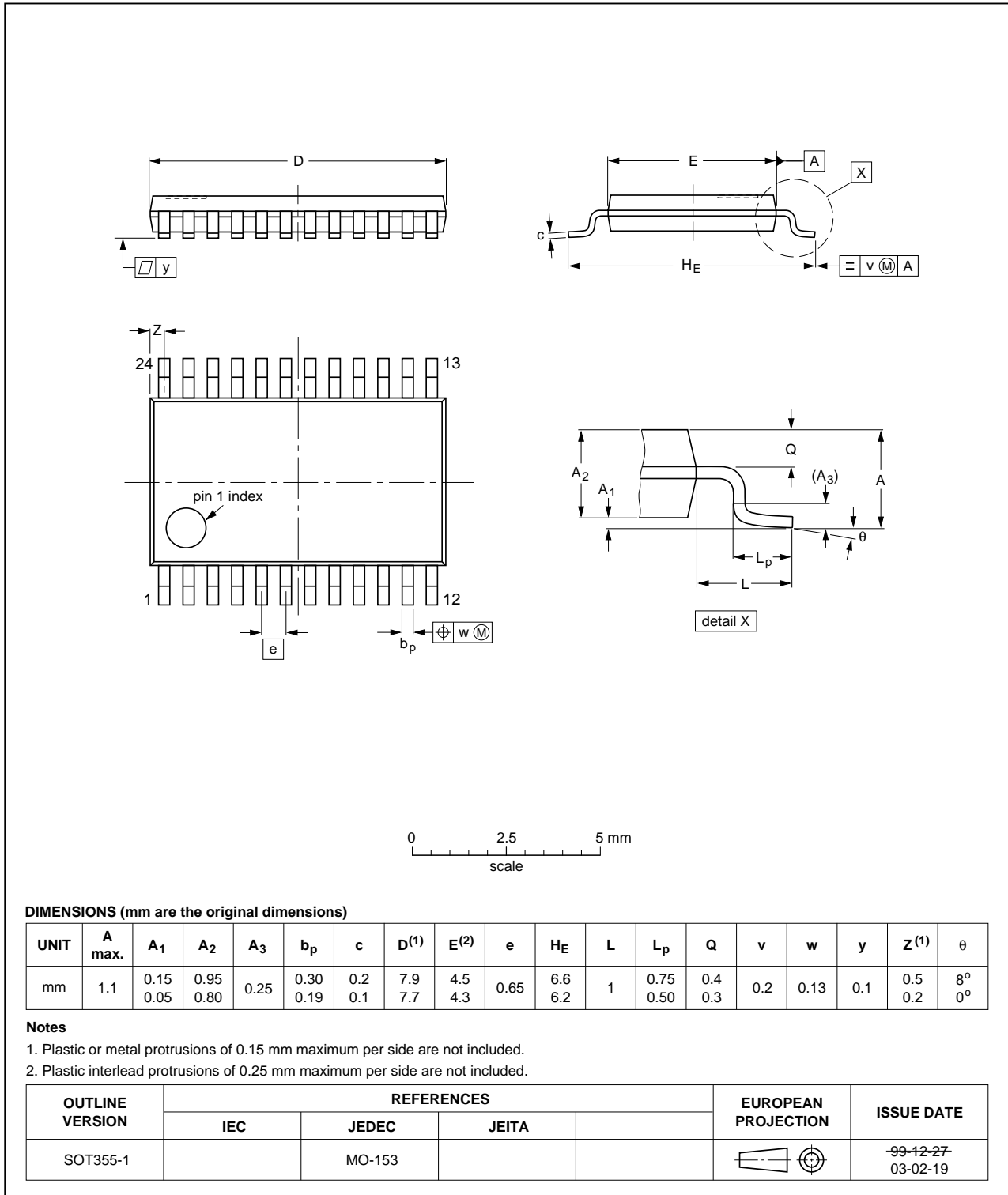
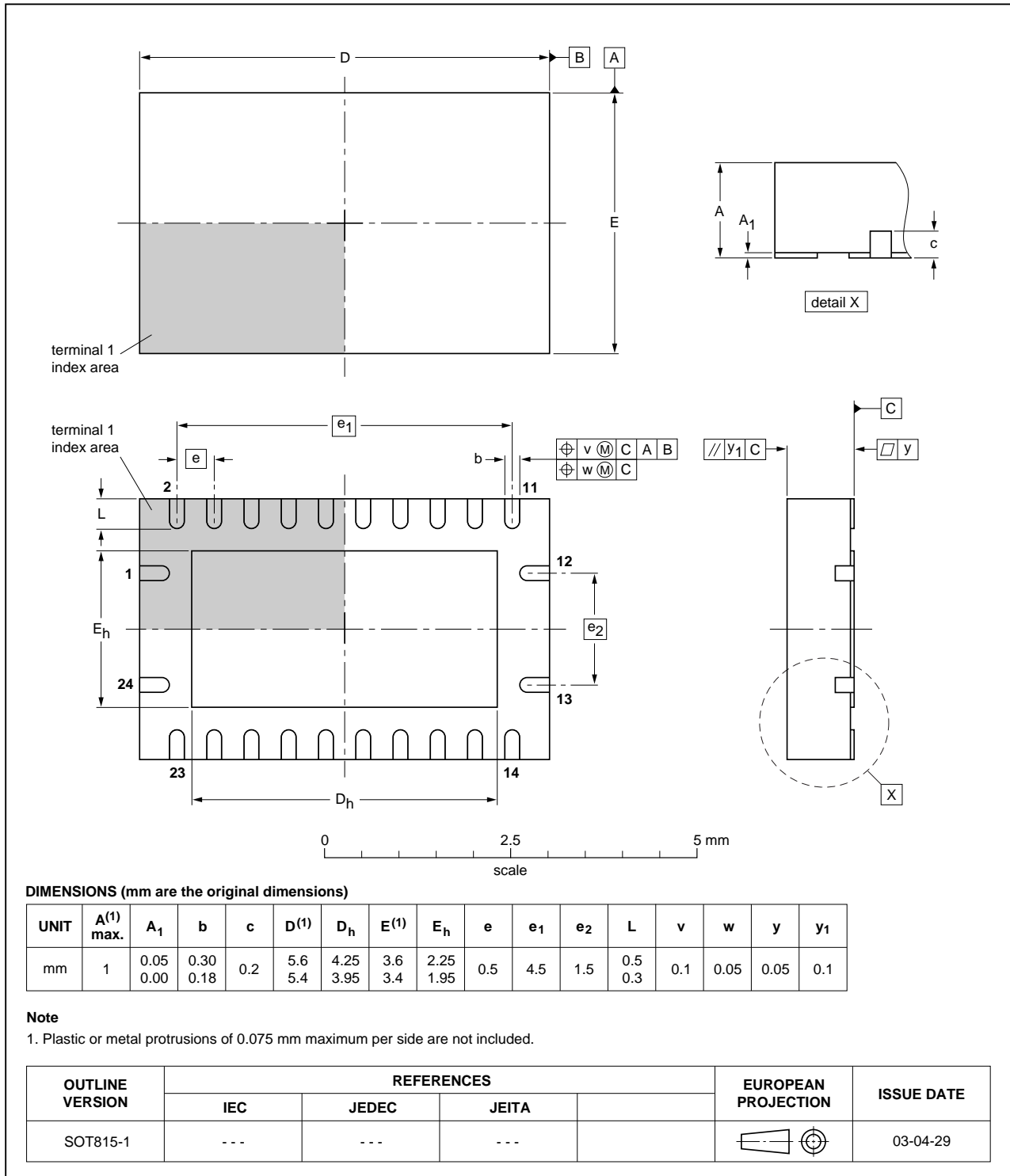

Fig 16. Package outline SOT355-1 (TSSOP24)

**DHVQFN24: plastic dual in-line compatible thermal enhanced very thin quad flat package; no leads; 24 terminals; body 3.5 x 5.5 x 0.85 mm**

**SOT815-1**



**Fig 17. Package outline SOT815-1 (DHVQFN24)**

## 15. Abbreviations

Table 18. Abbreviations

Acronym	Description
CDM	Charged Device Model
DUT	Device Under Test
HBM	Human Body Model
MM	Machine Model

## 16. Revision history

Table 19. Revision history

Document ID	Release date	Data sheet status	Change notice	Supersedes
74LVC_LVCH8T245 v.3	20111212	Product data sheet	-	74LVC_LVCH8T245 v.2
Modifications:	• Legal pages updated.			
74LVC_LVCH8T245 v.2	20110211	Product data sheet	-	74LVC_LVCH8T245 v.1
74LVC_LVCH8T245 v.1	20100111	Product data sheet	-	-

## 17. Legal information

### 17.1 Data sheet status

Document status <sup>[1][2]</sup>	Product status <sup>[3]</sup>	Definition
Objective [short] data sheet	Development	This document contains data from the objective specification for product development.
Preliminary [short] data sheet	Qualification	This document contains data from the preliminary specification.
Product [short] data sheet	Production	This document contains the product specification.

[1] Please consult the most recently issued document before initiating or completing a design.

[2] The term 'short data sheet' is explained in section "Definitions".

[3] The product status of device(s) described in this document may have changed since this document was published and may differ in case of multiple devices. The latest product status information is available on the Internet at URL <http://www.nexperia.com>.

### 17.2 Definitions

**Draft** — The document is a draft version only. The content is still under internal review and subject to formal approval, which may result in modifications or additions. Nexperia does not give any representations or warranties as to the accuracy or completeness of information included herein and shall have no liability for the consequences of use of such information.

**Short data sheet** — A short data sheet is an extract from a full data sheet with the same product type number(s) and title. A short data sheet is intended for quick reference only and should not be relied upon to contain detailed and full information. For detailed and full information see the relevant full data sheet, which is available on request via the local Nexperia sales office. In case of any inconsistency or conflict with the short data sheet, the full data sheet shall prevail.

**Product specification** — The information and data provided in a Product data sheet shall define the specification of the product as agreed between Nexperia and its customer, unless Nexperia and customer have explicitly agreed otherwise in writing. In no event however, shall an agreement be valid in which the Nexperia product is deemed to offer functions and qualities beyond those described in the Product data sheet.

### 17.3 Disclaimers

**Limited warranty and liability** — Information in this document is believed to be accurate and reliable. However, Nexperia does not give any representations or warranties, expressed or implied, as to the accuracy or completeness of such information and shall have no liability for the consequences of use of such information.

In no event shall Nexperia be liable for any indirect, incidental, punitive, special or consequential damages (including - without limitation - lost profits, lost savings, business interruption, costs related to the removal or replacement of any products or rework charges) whether or not such damages are based on tort (including negligence), warranty, breach of contract or any other legal theory.

Notwithstanding any damages that customer might incur for any reason whatsoever, Nexperia's aggregate and cumulative liability towards customer for the products described herein shall be limited in accordance with the *Terms and conditions of commercial sale* of Nexperia.

**Right to make changes** — Nexperia reserves the right to make changes to information published in this document, including without limitation specifications and product descriptions, at any time and without notice. This document supersedes and replaces all information supplied prior to the publication hereof.

**Suitability for use** — Nexperia products are not designed, authorized or warranted to be suitable for use in life support, life-critical or safety-critical systems or equipment, nor in applications where failure or

malfunction of a Nexperia product can reasonably be expected to result in personal injury, death or severe property or environmental damage. Nexperia accepts no liability for inclusion and/or use of Nexperia products in such equipment or applications and therefore such inclusion and/or use is at the customer's own risk.

**Applications** — Applications that are described herein for any of these products are for illustrative purposes only. Nexperia makes no representation or warranty that such applications will be suitable for the specified use without further testing or modification.

Customers are responsible for the design and operation of their applications and products using Nexperia products, and Nexperia accepts no liability for any assistance with applications or customer product design. It is customer's sole responsibility to determine whether the Nexperia product is suitable and fit for the customer's applications and products planned, as well as for the planned application and use of customer's third party customer(s). Customers should provide appropriate design and operating safeguards to minimize the risks associated with their applications and products.

Nexperia does not accept any liability related to any default, damage, costs or problem which is based on any weakness or default in the customer's applications or products, or the application or use by customer's third party customer(s). Customer is responsible for doing all necessary testing for the customer's applications and products using Nexperia products in order to avoid a default of the applications and the products or of the application or use by customer's third party customer(s). Nexperia does not accept any liability in this respect.

**Limiting values** — Stress above one or more limiting values (as defined in the Absolute Maximum Ratings System of IEC 60134) will cause permanent damage to the device. Limiting values are stress ratings only and (proper) operation of the device at these or any other conditions above those given in the Recommended operating conditions section (if present) or the Characteristics sections of this document is not warranted. Constant or repeated exposure to limiting values will permanently and irreversibly affect the quality and reliability of the device.

**Terms and conditions of commercial sale** — Nexperia products are sold subject to the general terms and conditions of commercial sale, as published at <http://www.nexperia.com/profile/terms>, unless otherwise agreed in a valid written individual agreement. In case an individual agreement is concluded only the terms and conditions of the respective agreement shall apply. Nexperia hereby expressly objects to applying the customer's general terms and conditions with regard to the purchase of Nexperia products by customer.

**No offer to sell or license** — Nothing in this document may be interpreted or construed as an offer to sell products that is open for acceptance or the grant, conveyance or implication of any license under any copyrights, patents or other industrial or intellectual property rights.

**Export control** — This document as well as the item(s) described herein may be subject to export control regulations. Export might require a prior authorization from competent authorities.

**Non-automotive qualified products** — Unless this data sheet expressly states that this specific Nexperia product is automotive qualified, the product is not suitable for automotive use. It is neither qualified nor tested in accordance with automotive testing or application requirements. Nexperia accepts no liability for inclusion and/or use of non-automotive qualified products in automotive equipment or applications.

In the event that customer uses the product for design-in and use in automotive applications to automotive specifications and standards, customer (a) shall use the product without Nexperia's warranty of the product for such automotive applications, use and specifications, and (b) whenever customer uses the product for automotive applications beyond

Nexperia's specifications such use shall be solely at customer's own risk, and (c) customer fully indemnifies Nexperia for any liability, damages or failed product claims resulting from customer design and use of the product for automotive applications beyond Nexperia's standard warranty and Nexperia's product specifications.

## 17.4 Trademarks

Notice: All referenced brands, product names, service names and trademarks are the property of their respective owners.

## 18. Contact information

For more information, please visit: <http://www.nexperia.com>

For sales office addresses, please send an email to: [salesaddresses@nexperia.com](mailto:salesaddresses@nexperia.com)



## 19. Contents

---

<b>1</b>	<b>General description</b> . . . . .	<b>1</b>
<b>2</b>	<b>Features and benefits</b> . . . . .	<b>1</b>
<b>3</b>	<b>Ordering information</b> . . . . .	<b>2</b>
<b>4</b>	<b>Functional diagram</b> . . . . .	<b>2</b>
<b>5</b>	<b>Pinning information</b> . . . . .	<b>3</b>
5.1	Pinning . . . . .	3
5.2	Pin description . . . . .	4
<b>6</b>	<b>Functional description</b> . . . . .	<b>4</b>
<b>7</b>	<b>Limiting values</b> . . . . .	<b>4</b>
<b>8</b>	<b>Recommended operating conditions</b> . . . . .	<b>5</b>
<b>9</b>	<b>Static characteristics</b> . . . . .	<b>5</b>
<b>10</b>	<b>Dynamic characteristics</b> . . . . .	<b>10</b>
<b>11</b>	<b>Waveforms</b> . . . . .	<b>13</b>
<b>12</b>	<b>Typical propagation delay characteristics</b> . . . . .	<b>15</b>
<b>13</b>	<b>Application information</b> . . . . .	<b>21</b>
13.1	Unidirectional logic level-shifting application . . . . .	21
13.2	Bidirectional logic level-shifting application . . . . .	22
13.3	Power-up considerations . . . . .	22
<b>14</b>	<b>Package outline</b> . . . . .	<b>23</b>
<b>15</b>	<b>Abbreviations</b> . . . . .	<b>25</b>
<b>16</b>	<b>Revision history</b> . . . . .	<b>25</b>
<b>17</b>	<b>Legal information</b> . . . . .	<b>26</b>
17.1	Data sheet status . . . . .	26
17.2	Definitions . . . . .	26
17.3	Disclaimers . . . . .	26
17.4	Trademarks . . . . .	27
<b>18</b>	<b>Contact information</b> . . . . .	<b>27</b>
<b>19</b>	<b>Contents</b> . . . . .	<b>28</b>

## Looking for pricing, stock, or lifecycle information?

Click below to explore more details on WIN SOURCE:

-  [View 74LVC8T245PW,118 on WIN SOURCE](#)
-  [NXP / Nexperia Information](#)

## Optimize Your Supply Chain with WIN SOURCE Solutions

-  Global Sourcing Solution
-  Obsolete Management
-  Cost Control Management
-  Shortage Management
-  Alternative Solution
-  Excess Inventory Management