



# THE DATASHEET OF STPSC406B-TR



**600 V power Schottky silicon carbide diode**

Datasheet - production data

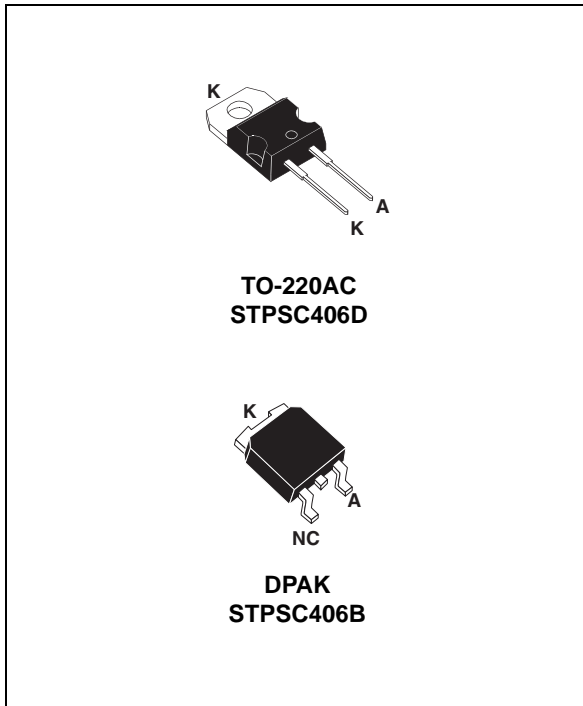
**Description**

The SiC diode is an ultrahigh performance power Schottky diode. It is manufactured using a silicon carbide substrate. The wide bandgap material allows the design of a Schottky diode structure with a 600 V rating. Due to the Schottky construction no recovery is shown at turn-off and ringing patterns are negligible. The minimal capacitive turn-off behavior is independent of temperature.

ST SiC diodes will boost the performance of PFC operations in hard switching conditions.

**Table 1. Device summary**

$I_{F(AV)}$	4 A
$V_{RRM}$	600 V
$T_j (max)$	175 °C
$Q_C (typ)$	3 nC

**Features**

- No or negligible reverse recovery
- Switching behavior independent of temperature
- Dedicated to PFC boost diode

# 1 Characteristics

**Table 2. Absolute ratings (limiting values at 25 °C unless otherwise specified)**

Symbol	Parameter		Value	Unit
V <sub>RRM</sub>	Repetitive peak reverse voltage		600	V
I <sub>F(RMS)</sub>	Forward rms current		11	A
I <sub>F(AV)</sub>	Average forward current	DPAK, T <sub>c</sub> = 110 °C, δ = 0.5	4	A
		TO-220AC, T <sub>c</sub> = 95 °C, δ = 0.5		
I <sub>FSM</sub>	Surge non repetitive forward current	t <sub>p</sub> = 10 ms sinusoidal, T <sub>c</sub> = 25 °C	14	A
		t <sub>p</sub> = 10 ms sinusoidal, T <sub>c</sub> = 125 °C	10	
		t <sub>p</sub> = 10 μs square, T <sub>c</sub> = 25 °C	40	
I <sub>FRM</sub>	Repetitive peak forward current	DPAK, T <sub>c</sub> = 115 °C, T <sub>j</sub> = 150 °C, δ = 0.1	14	A
		TO-220AC, T <sub>c</sub> = 105 °C, T <sub>j</sub> = 150 °C, δ = 0.1		
T <sub>stg</sub>	Storage temperature range		-55 to +175	°C
T <sub>j</sub>	Operating junction temperature <sup>(1)</sup>		-40 to +175	°C

1.  $\frac{dP_{tot}}{dT_j} < \frac{1}{R_{th(j-a)}}$  condition to avoid thermal runaway for a diode on its own heatsink

**Table 3. Thermal resistance**

Symbol	Parameter		Value	Unit
R <sub>th(j-c)</sub>	Junction to case	TO-220AC	5.5	°C/W
		DPAK	4.5	

**Table 4. Static electrical characteristics**

Symbol	Parameter	Tests conditions		Min.	Typ.	Max.	Unit
I <sub>R</sub> <sup>(1)</sup>	Reverse leakage current	T <sub>j</sub> = 25 °C	V <sub>R</sub> = V <sub>RRM</sub>	-	10	50	μA
		T <sub>j</sub> = 150 °C		-	60	500	
V <sub>F</sub> <sup>(2)</sup>	Forward voltage drop	T <sub>j</sub> = 25 °C	I <sub>F</sub> = 4 A	-	1.55	1.9	V
		T <sub>j</sub> = 150 °C		-	1.9	2.4	

1. t<sub>p</sub> = 10 ms, δ < 2%

2. t<sub>p</sub> = 500 μs, δ < 2%

To evaluate the conduction losses use the following equation:

$$P = 1.20 \times I_{F(AV)} + 0.3 \times I_{F(RMS)}^2$$

Table 5. Other parameters

Symbol	Parameter	Test conditions	Typ.	Unit
$Q_C$	Total capacitive charge	$V_r = 400\text{ V}$ , $I_F = 4\text{ A}$ , $di_F/dt = -200\text{ A}/\mu\text{s}$ $T_j = 150\text{ }^\circ\text{C}$	3	nC
C	Total capacitance	$V_r = 0\text{ V}$ , $T_C = 25\text{ }^\circ\text{C}$ , $F = 1\text{ Mhz}$	200	pF
		$V_r = 400\text{ V}$ , $T_C = 25\text{ }^\circ\text{C}$ , $F = 1\text{ Mhz}$	20	

Figure 1. Forward voltage drop versus forward current (typical values)

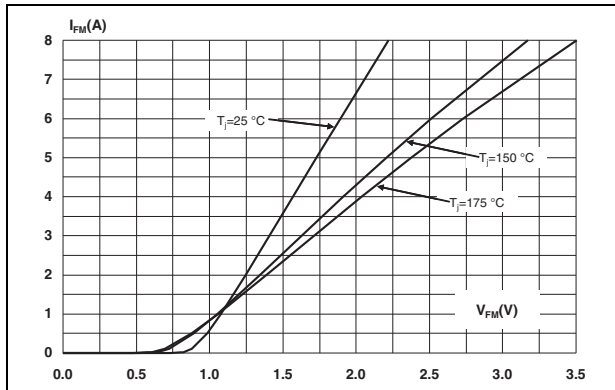

Figure 2. Reverse leakage current versus reverse voltage applied (maximum values)

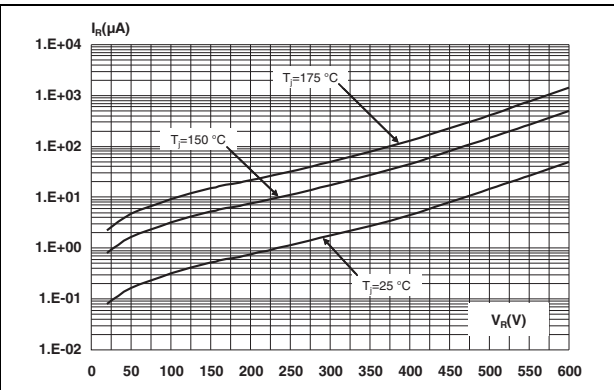

Figure 3. Peak forward current versus case temperature (TO-220AC)

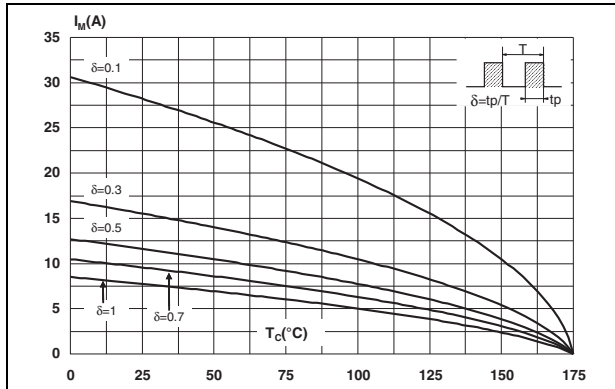
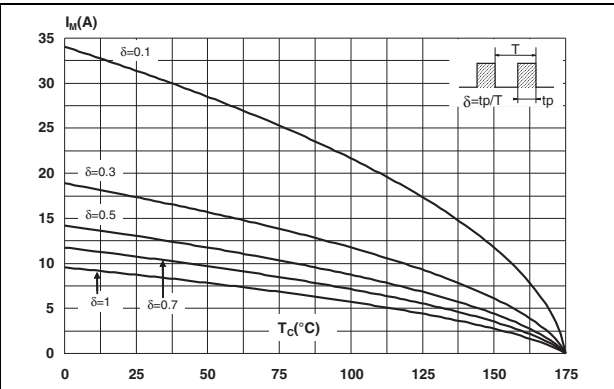
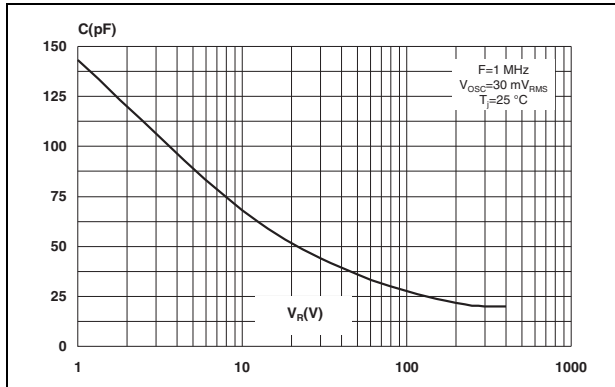

Figure 4. Peak forward current versus case temperature (DPAK)



**Figure 5. Junction capacitance versus reverse voltage applied (typical values)**



**Figure 6. Relative variation of thermal impedance junction to case versus pulse duration (TO-220AC)**

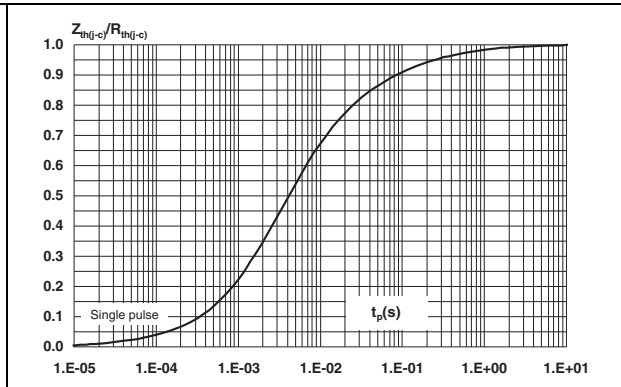

**Figure 7. Relative variation of thermal impedance junction to case versus pulse duration (DPAK)**

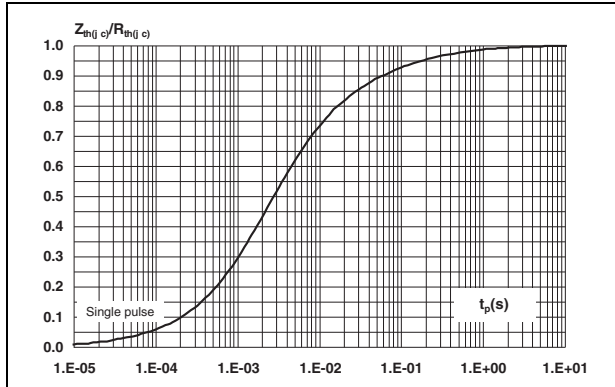

**Figure 8. Non-repetitive peak surge forward current versus pulse duration (sinusoidal waveform)**

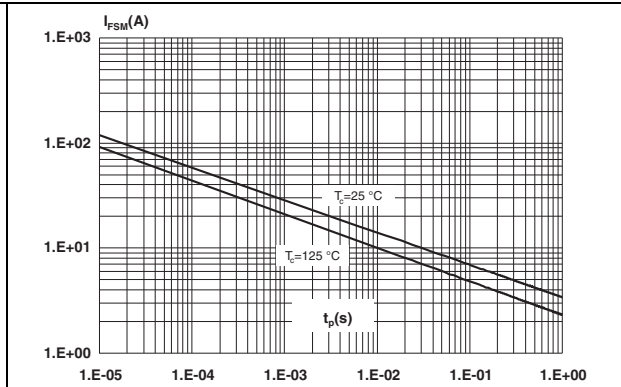

**Figure 9. Total capacitive charges versus  $dI_F/dt$  (typical values)**

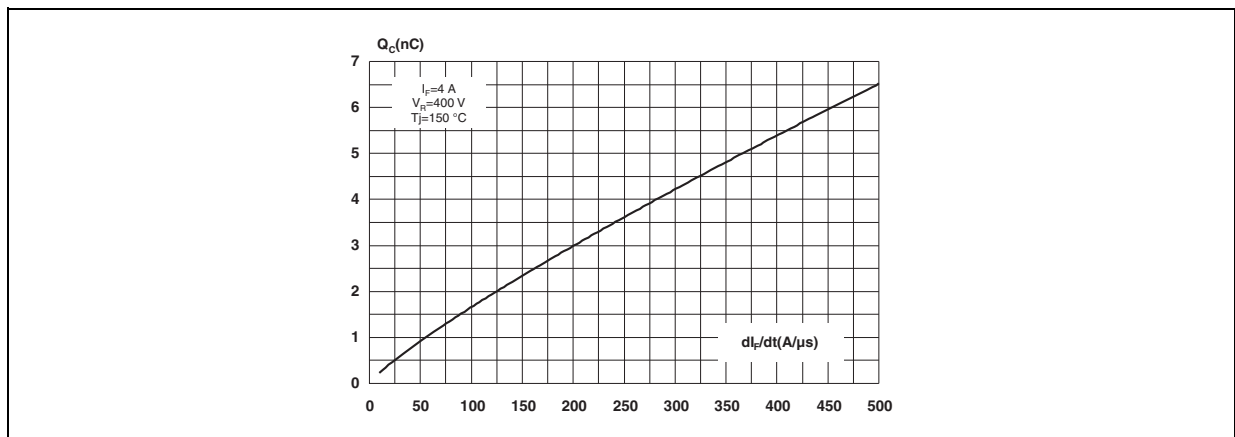

## 2 Package information

- Epoxy meets UL94, V0
- Cooling method: convection (C)
- Recommended torque: 0.4 to 0.6 N·m

In order to meet environmental requirements, ST offers these devices in different grades of ECOPACK® packages, depending on their level of environmental compliance. ECOPACK® specifications, grade definitions and product status are available at: [www.st.com](http://www.st.com). ECOPACK® is an ST trademark.

Table 6. TO-220AC dimensions

Ref.	Dimensions			
	Millimeters		Inches	
	Min.	Max.	Min.	Max.
A	4.40	4.60	0.173	0.181
C	1.23	1.32	0.048	0.051
D	2.40	2.72	0.094	0.107
E	0.49	0.70	0.019	0.027
F	0.61	0.88	0.024	0.034
F1	1.14	1.70	0.044	0.066
G	4.95	5.15	0.194	0.202
H2	10.00	10.40	0.393	0.409
L2	16.40 typ.		0.645 typ.	
L4	13.00	14.00	0.511	0.551
L5	2.65	2.95	0.104	0.116
L6	15.25	15.75	0.600	0.620
L7	6.20	6.60	0.244	0.259
L9	3.50	3.93	0.137	0.154
M	2.6 typ.		0.102 typ.	
Diam. I	3.75	3.85	0.147	0.151

Table 7. DPAK dimensions

Ref.	Dimensions			
	Millimeters		Inches	
	Min.	Max.	Min.	Max.
A	2.20	2.40	0.086	0.094
A1	0.90	1.10	0.035	0.043
A2	0.03	0.23	0.001	0.009
B	0.64	0.90	0.025	0.035
B2	5.20	5.40	0.204	0.212
C	0.45	0.60	0.017	0.023
C2	0.48	0.60	0.018	0.023
D	6.00	6.20	0.236	0.244
E	6.40	6.60	0.251	0.259
G	4.40	4.60	0.173	0.181
H	9.35	10.10	0.368	0.397
L2	0.80 typ.		0.031 typ.	
L4	0.60	1.00	0.023	0.039
V2	0°	8°	0°	8°

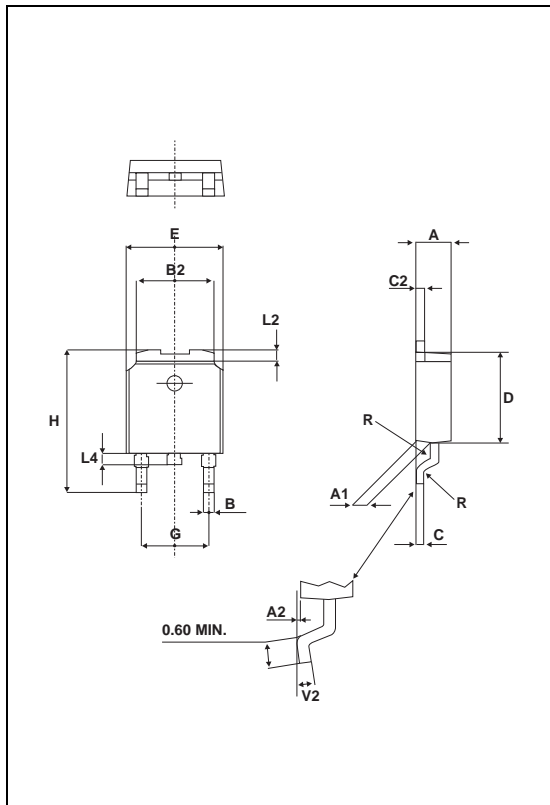
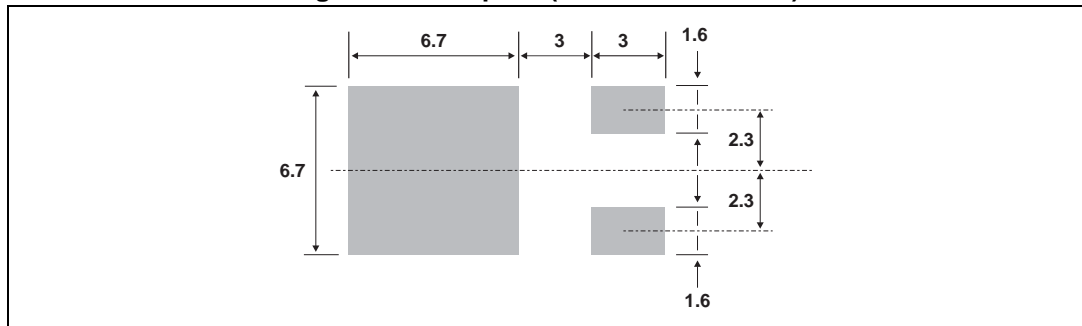

Figure 10. Footprint (dimensions in mm)



### 3 Ordering information

**Table 8. Ordering information**

Order code	Marking	Package	Weight	Base qty	Delivery mode
STPSC406D	STPSC406D	TO-220AC	1.86 g	50	Tube
STPSC406B-TR	STPSC 406B	DPAK	0.3g	2500	Tape and reel

### 4 Revision history

**Table 9. Document revision history**

Date	Revision	Changes
24-Sep-2009	1	First issue.
12-Aug-2015	2	Updated <a href="#">Table 8: Ordering information</a> .

**IMPORTANT NOTICE – PLEASE READ CAREFULLY**

STMicroelectronics NV and its subsidiaries ("ST") reserve the right to make changes, corrections, enhancements, modifications, and improvements to ST products and/or to this document at any time without notice. Purchasers should obtain the latest relevant information on ST products before placing orders. ST products are sold pursuant to ST's terms and conditions of sale in place at the time of order acknowledgement.

Purchasers are solely responsible for the choice, selection, and use of ST products and ST assumes no liability for application assistance or the design of Purchasers' products.

No license, express or implied, to any intellectual property right is granted by ST herein.

Resale of ST products with provisions different from the information set forth herein shall void any warranty granted by ST for such product.



ST and the ST logo are trademarks of ST. All other product or service names are the property of their respective owners.

Information in this document supersedes and replaces information previously supplied in any prior versions of this document.

© 2015 STMicroelectronics – All rights reserved

## Looking for pricing, stock, or lifecycle information?

Click below to explore more details on WIN SOURCE:

-  [View STPSC406B-TR on WIN SOURCE](#)
-  [STMicroelectronics Information](#)

## Optimize Your Supply Chain with WIN SOURCE Solutions

-  Global Sourcing Solution
-  Obsolete Management
-  Cost Control Management
-  Shortage Management
-  Alternative Solution
-  Excess Inventory Management