



THE DATASHEET OF STPS2045CG-TR



Power Schottky rectifier

Datasheet - production data

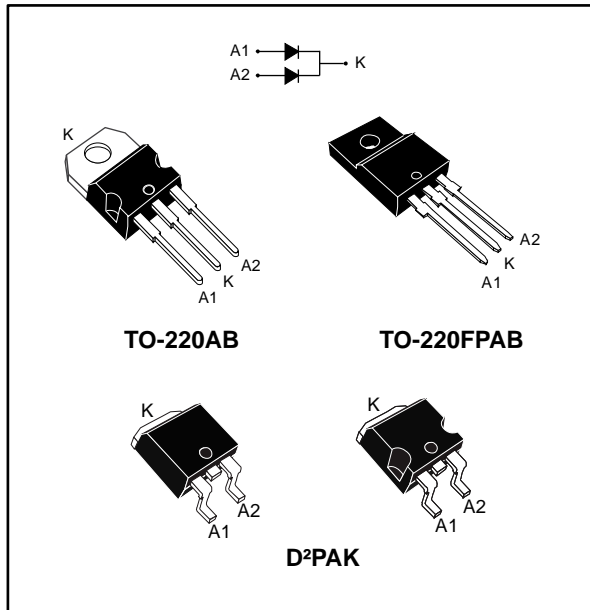

Description

Dual center tap Schottky rectifier suited for switch mode power supply and high frequency DC to DC converters. Packaged either in TO-220AB, TO-220FPAB, or D²PAK, this device is especially intended for use in low voltage, high frequency inverters, free wheeling and polarity protection applications.

Table 1: Device summary

Symbol	Value
$I_{F(AV)}$	2 x 10 A
V_{RRM}	45 V
V_F (typ.)	0.5 V
T_j (max.)	175 °C

Features

- Very small conduction losses
- Negligible switching losses
- Extremely fast switching
- Insulated package: TO-220FPAB
 - Insulating voltage = 2000 V_{RMS} sine
- Avalanche rated
- ECOPACK[®]2 compliant component for D²PAK on demand

1 Characteristics

Table 2: Absolute ratings (limiting values, per diode, at 25 °C, unless otherwise specified)

Symbol	Parameter			Value	Unit	
V _{RRM}	Repetitive peak reverse voltage			45	V	
I _{F(RMS)}	Forward rms current			30	A	
I _{F(AV)}	Average forward current δ = 0.5, square wave	TO-220AB / D ² PAK	T _C = 155 °C	Per diode	10	A
				Per device	20	
		TO-220FPAB	T _C = 140 °C	Per diode	10	
			T _C = 125 °C	Per device	20	
I _{FSM}	Surge non repetitive forward current		t _p = 10 ms sinusoidal	180	A	
P _{ARM} ⁽¹⁾	Repetitive peak avalanche power		t _p = 10 μs, T _j = 125 °C	280	W	
V _{ARM} ⁽²⁾	Maximum repetitive peak avalanche voltage		t _p < 10 μs, T _j < 125 °C, I _{AR} < 7.7 A	60	V	
V _{ASM} ⁽²⁾	Maximum single-pulse peak avalanche voltage					
T _{stg}	Storage temperature range			-65 to +175	°C	
T _j	Maximum operating junction temperature ⁽³⁾			175		

Notes:

⁽¹⁾For pulse time duration deratings, please refer to [Figure 3](#). More details regarding the avalanche energy measurements and diode validation in the avalanche are provided in the STMicroelectronics Application notes AN1768, "Admissible avalanche power of Schottky diodes" and AN2025, "Converter improvement using Schottky rectifier avalanche specification".

⁽²⁾See [Figure 9](#).

⁽³⁾(dP_{tot}/dT_j) < (1/R_{th(j-a)}) condition to avoid thermal runaway for a diode on its own heatsink.

Table 3: Thermal parameters

Symbol	Parameter		Max. value	Unit	
R _{th(j-c)}	Junction to case	TO-220AB / D ² PAK	Per diode	2.2	°C/W
			Total	1.4	
		TO-220FPAB	Per diode	4.5	
			Total	3.5	
R _{th(c)}	Coupling	TO-220AB / D ² PAK	0.4		
		TO-220FPAB	2.5		

When the diodes 1 and 2 are used simultaneously:

$$\Delta T_j (\text{diode1}) = P_{(\text{diode1})} \times R_{th(j-c)} (\text{per diode}) + P_{(\text{diode2})} \times R_{th(c)}$$

Table 4: Static electrical characteristics (per diode)

Symbol	Parameter	Test conditions		Min.	Typ.	Max.	Unit
$I_R^{(1)}$	Reverse leakage current	$T_j = 25\text{ °C}$	$V_R = V_{RRM}$	-		100	μA
		$T_j = 125\text{ °C}$		-	7	15	mA
$V_F^{(1)}$	Forward voltage drop	$T_j = 125\text{ °C}$	$I_F = 10\text{ A}$	-	0.5	0.57	V
		$T_j = 25\text{ °C}$	$I_F = 20\text{ A}$	-		0.84	
		$T_j = 125\text{ °C}$		-	0.65	0.72	

Notes:

⁽¹⁾Pulse test: $t_p = 380\text{ }\mu\text{s}$, $\delta < 2\%$

To evaluate the conduction losses, use the following equation:

$$P = 0.42 \times I_{F(AV)} + 0.015 \times I_{F(RMS)}^2$$

1.1 Characteristics (curves)

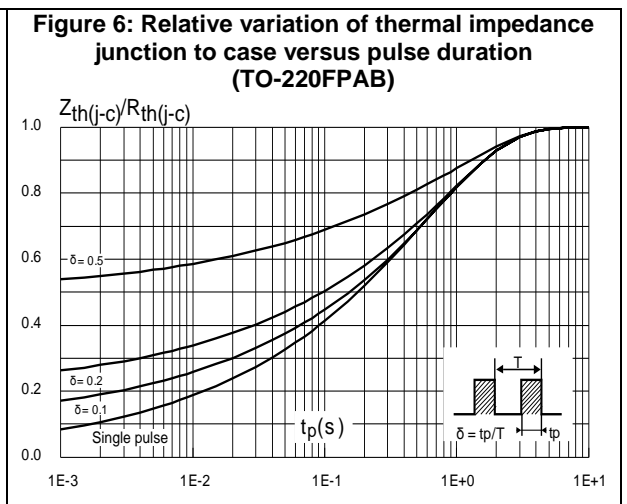
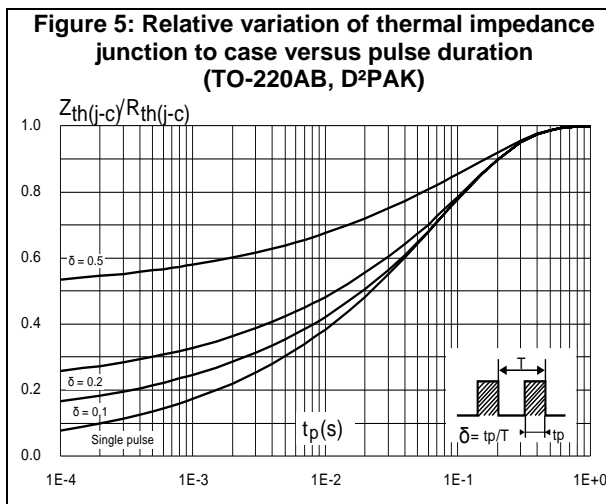
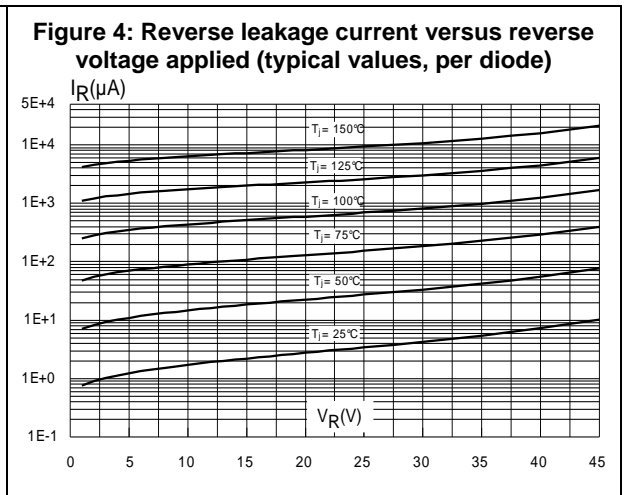
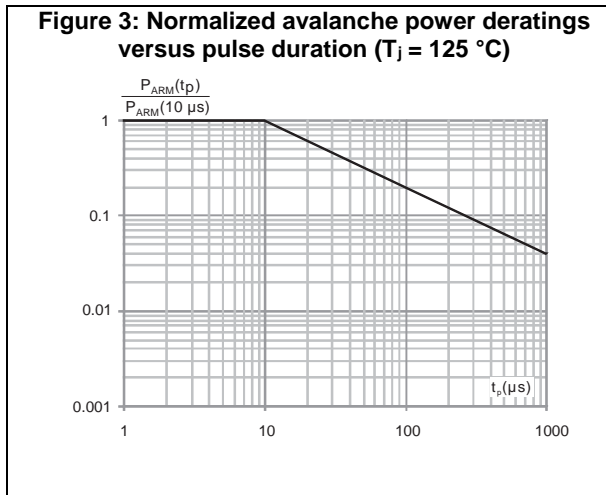
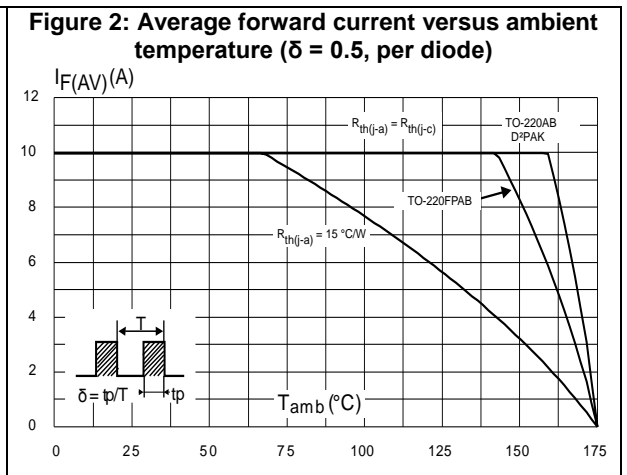
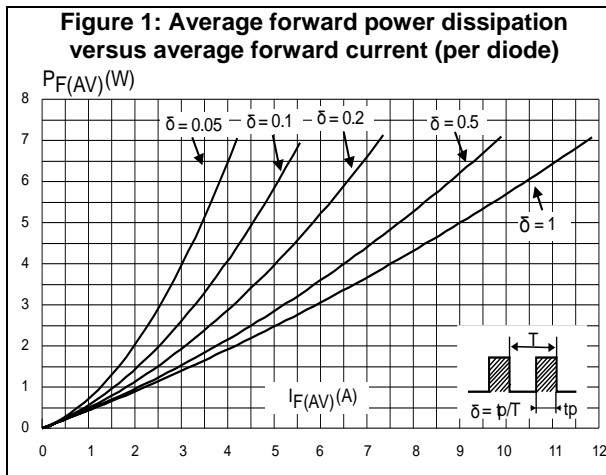

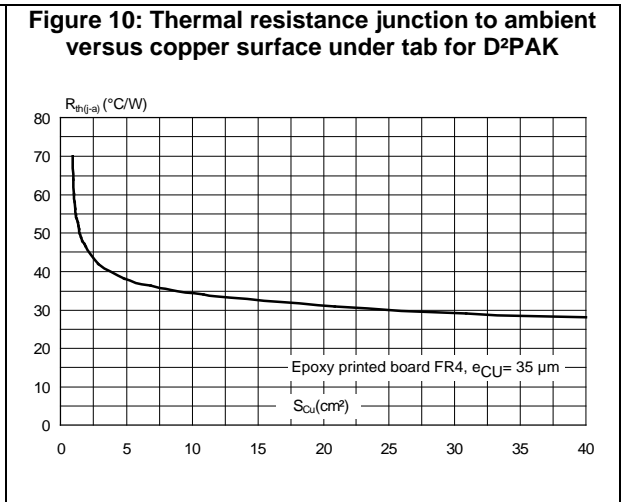
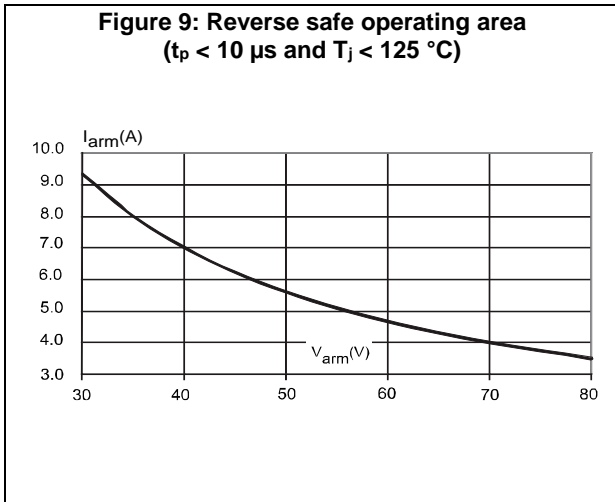
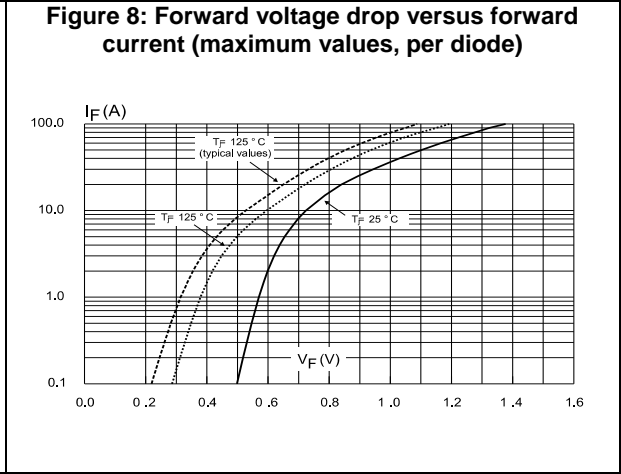
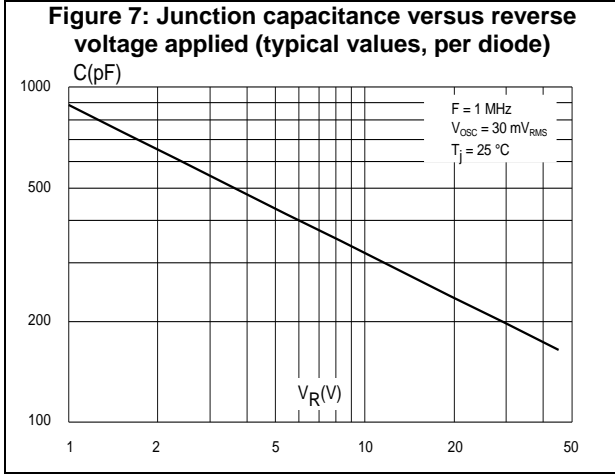

2 Package information

In order to meet environmental requirements, ST offers these devices in different grades of ECOPACK® packages, depending on their level of environmental compliance. ECOPACK® specifications, grade definitions and product status are available at: www.st.com. ECOPACK® is an ST trademark.

- Cooling method: by conduction (C)
- Epoxy meets UL 94, V0
- Recommended torque value: 0.55 N·m (for TO-220AB and TO-220FPAB)
- Maximum torque value: 0.7 N·m (for TO-220AB and TO-220FPAB)

2.1 TO-220AB package information

Figure 11: TO-220AB package outline

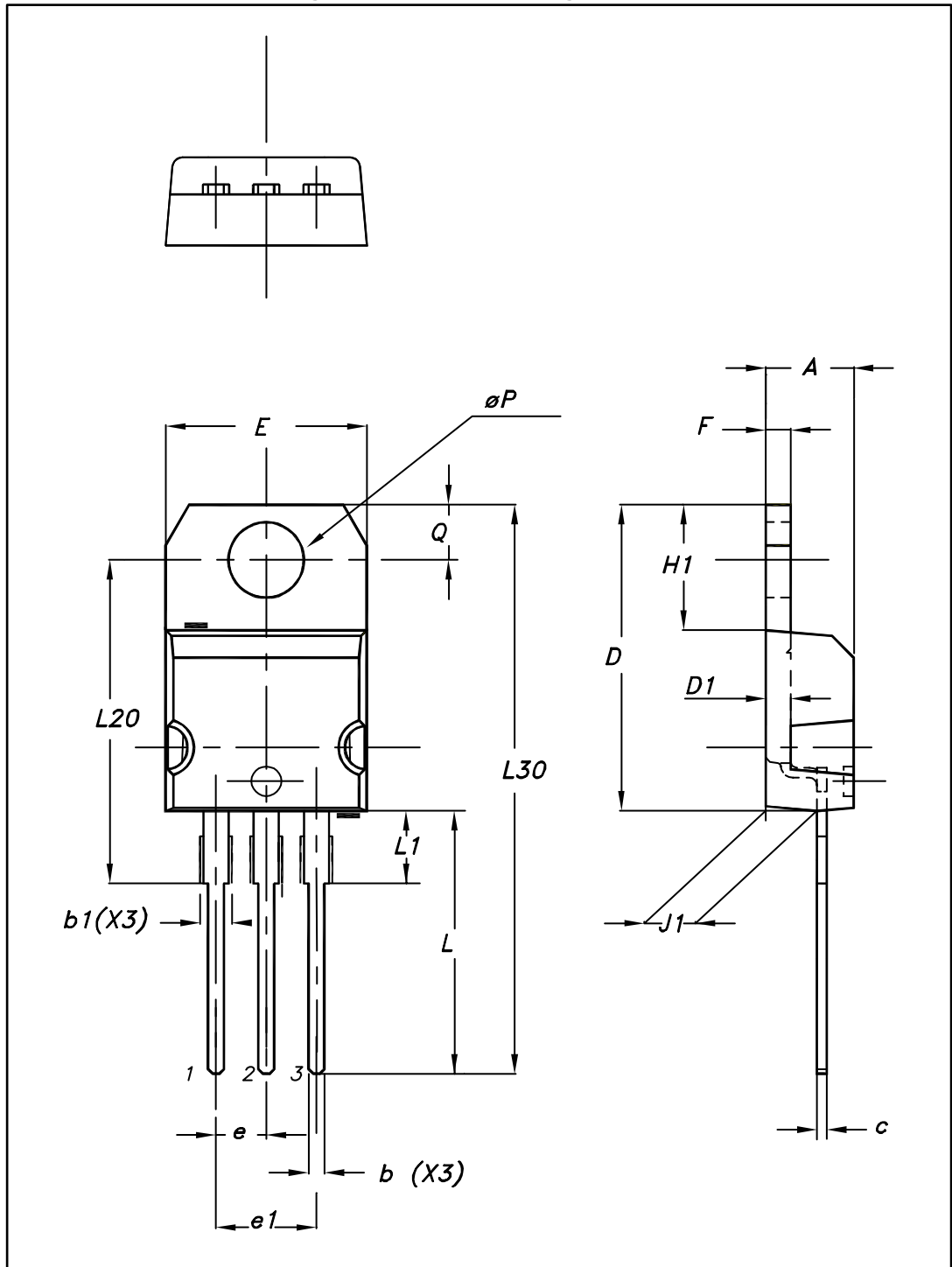

Table 5: TO-220AB package mechanical data

Ref.	Dimensions			
	Millimeters		Inches	
	Min.	Max.	Min.	Max.
A	4.40	4.60	0.173	0.181
b	0.61	0.88	0.240	0.035
b1	1.14	1.70	0.045	0.067
c	0.48	0.70	0.019	0.028
D	15.25	15.75	0.600	0.620
D1	1.27 typ.		0.050 typ.	
E	10.00	10.40	0.394	0.409
e	2.40	2.70	0.094	0.106
e1	4.95	5.15	0.195	0.203
F	1.23	1.32	0.048	0.052
H1	6.20	6.60	0.244	0.260
J1	2.40	2.72	0.094	0.107
L	13.00	14.00	0.512	0.551
L1	3.50	3.93	0.138	0.155
L20	16.40 typ.		0.646 typ.	
L30	28.90 typ.		1.138 typ.	
θP	3.75	3.85	0.148	0.152
Q	2.65	2.95	0.104	0.116

2.2 TO-220FPAB package information

Figure 12: TO-220FPAB package outline

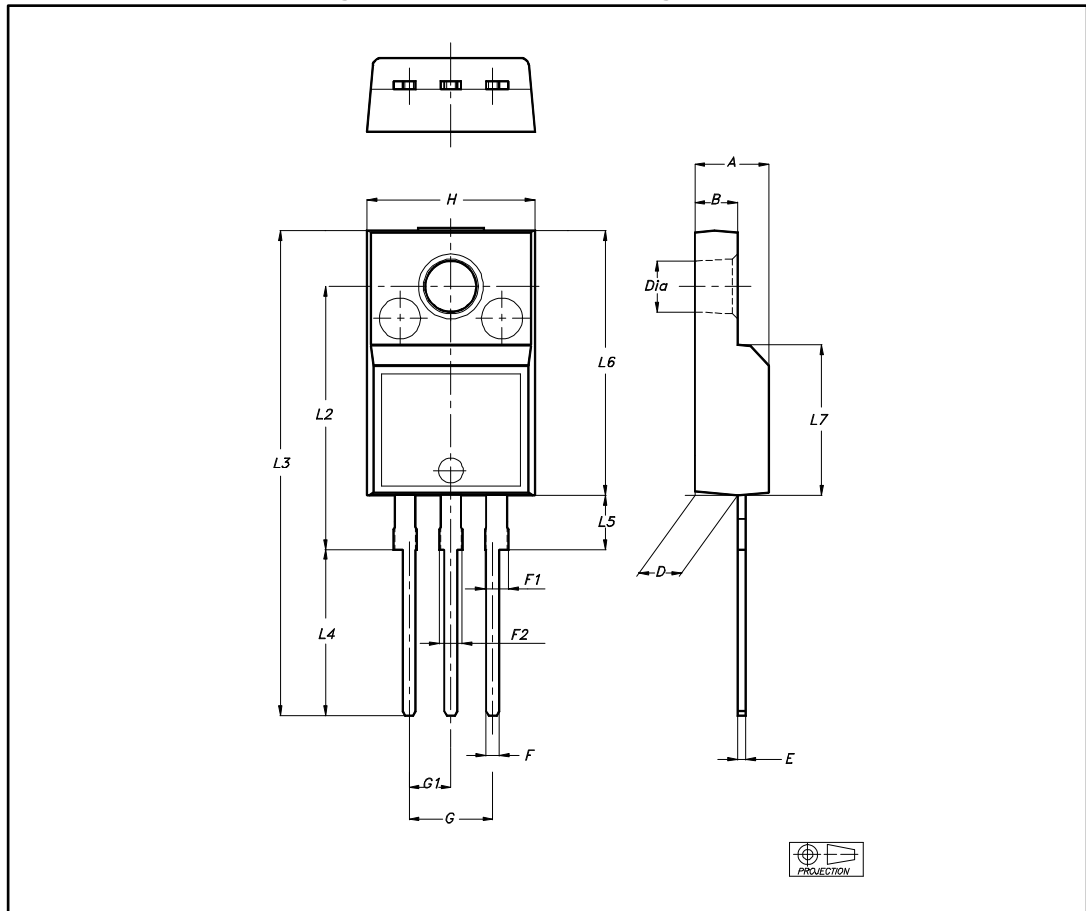
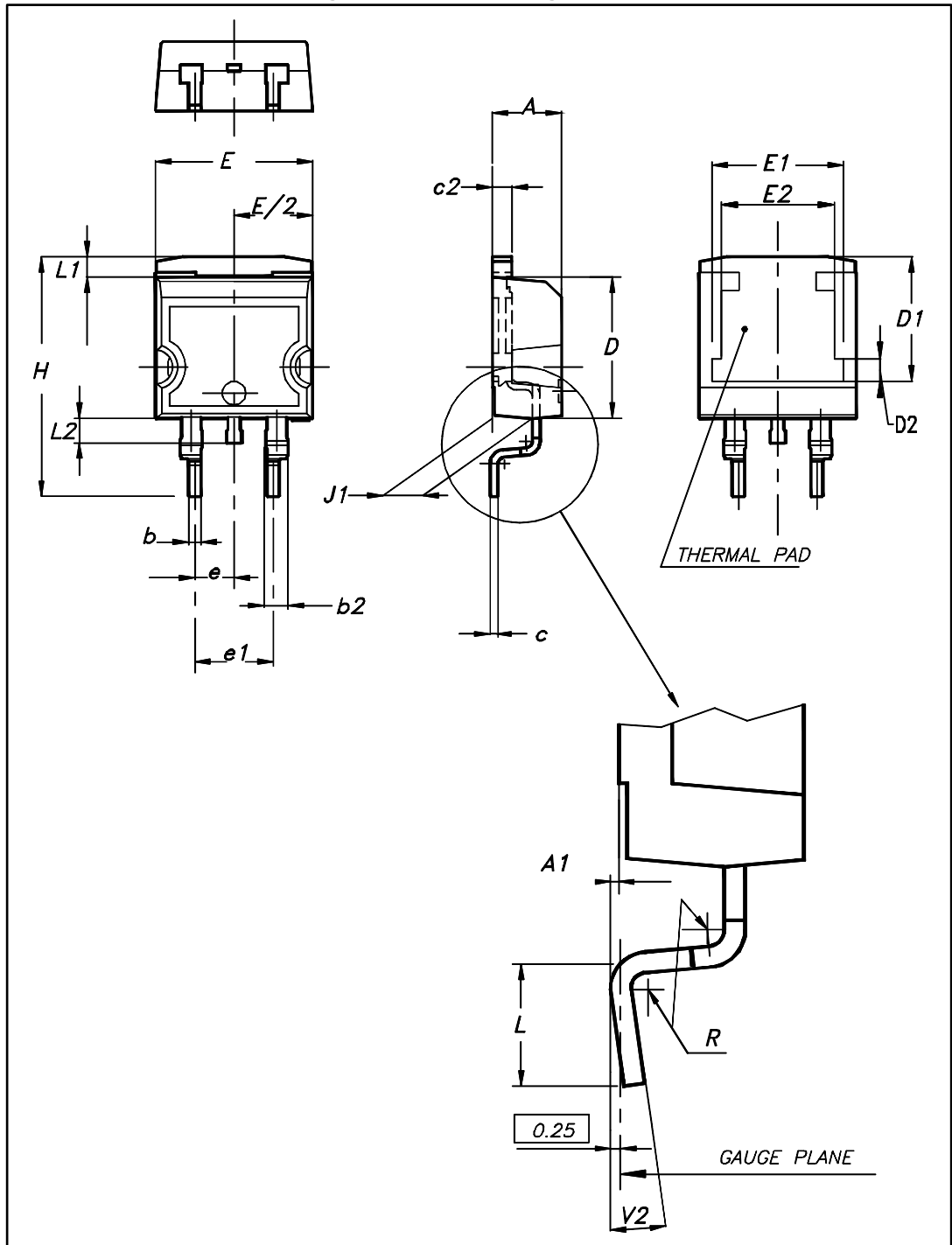

Table 6: TO-220FPAB package mechanical data

Ref.	Dimensions			
	Millimeters		Inches	
	Min.	Max.	Min.	Max.
A	4.40	4.60	0.173	0.181
B	2.5	2.7	0.098	0.106
D	2.5	2.75	0.098	0.108
E	0.45	0.70	0.018	0.028
F	0.75	1	0.030	0.039
F1	1.15	1.70	0.045	0.067
F2	1.15	1.70	0.045	0.067
G	4.95	5.2	0.195	0.205
G1	2.4	2.7	0.094	0.106
H	10	10.4	0.394	0.409
L2	16 typ.		0.63 typ.	
L3	28.60	30.6	1.126	1.205
L4	9.8	10.6	0.386	0.417
L5	2.9	3.6	0.114	0.142
L6	15.9	16.4	0.626	0.646
L7	9	9.3	0.354	0.366
Dia	3	3.2	0.118	0.126

2.3 D²PAK package information

Figure 13: D²PAK package outline



This package drawing may slightly differ from the physical package. However, all the specified dimensions are guaranteed.

Table 7: D²PAK package mechanical data

Ref.	Dimensions			
	Millimeters		Inches	
	Min.	Max.	Min.	Max.
A	4.36	4.60	0.172	0.181
A1	0.00	0.25	0.000	0.010
b	0.70	0.93	0.028	0.037
b2	1.14	1.70	0.045	0.067
c	0.38	0.69	0.015	0.027
c2	1.19	1.36	0.047	0.053
D	8.60	9.35	0.339	0.368
D1	6.90	8.00	0.272	0.311
D2	1.10	1.50	0.043	0.060
E	10.00	10.55	0.394	0.415
E1	8.10	8.90	0.319	0.346
E2	6.85	7.25	0.266	0.282
e	2.54 typ.		0.100	
e1	4.88	5.28	0.190	0.205
H	15.00	15.85	0.591	0.624
J1	2.49	2.90	0.097	0.112
L	1.90	2.79	0.075	0.110
L1	1.27	1.65	0.049	0.065
L2	1.30	1.78	0.050	0.070
R	0.4 typ.		0.015	
V2	0°	8°	0°	8°

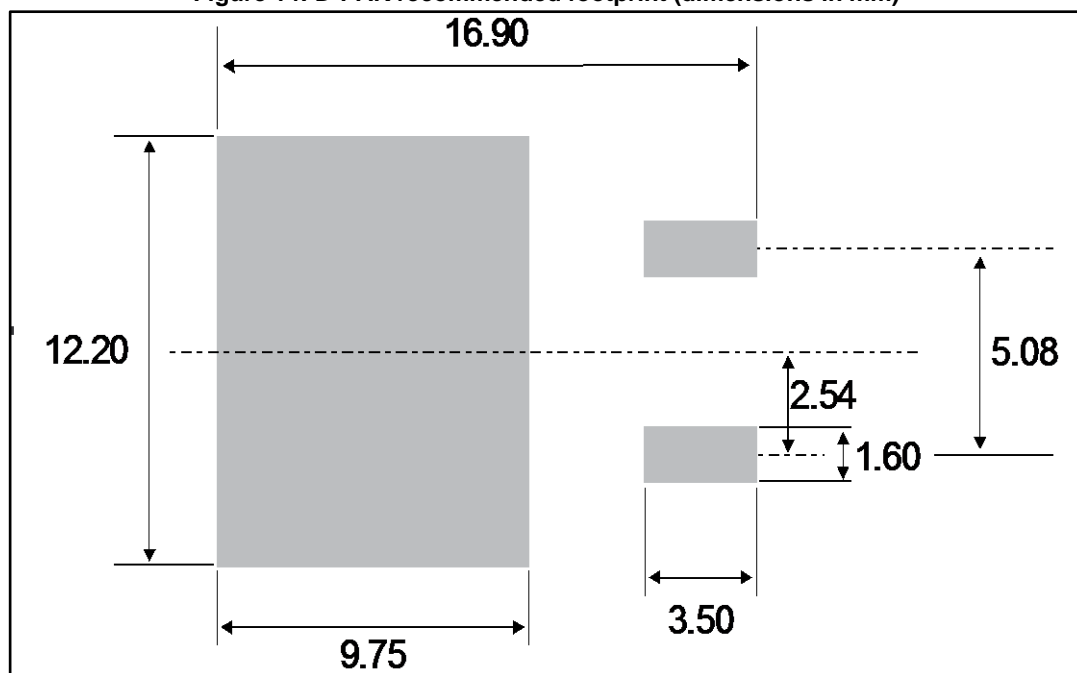
Figure 14: D²PAK recommended footprint (dimensions in mm)

3 Ordering information

Table 8: Ordering information

Order code	Marking	Package	Weight	Base qty.	Delivery mode
STPS2045CT	STPS2045CT	TO-220AB	1.95 g	50	Tube
STPS2045CFP	STPS2045CFP	TO-220FPAB	1.9 g	50	Tube
STPS2045CG-TR	STPS2045CG	D ² PAK	1.38 g	1000	Tape and reel

4 Revision history

Table 9: Document revision history

Date	Revision	Changes
05-Oct-2004	4F	Last update.
01-Dec-2004	5	Figure 16 (I ² PAK Package Mechanical Data): references b1 and b2 changed from 1.17mm to 1.70mm.
05-Feb-2010	6	Updated <i>Table 2</i> (removed voltage). Updated ECOPACK statement. Updated <i>Table 6</i> : <i>TO-220AB package mechanical data</i> .
05-Mar-2013	7	Updated <i>Table 3</i>
21-Oct-2014	8	Updated <i>Features</i> , <i>Table 2</i> , <i>Figure 3</i> and D ² PAK package information. Added <i>Figure 9</i> . Removed fig 4,5 and 6 of version 7.
17-Aug-2015	9	Corrected XML fragment and reformatted to current standard.
14-Oct-2016	10	Remove of I ² PAK package. Updated cover page, Section 3.1: "Characteristics (curves)" , Section 3: "Characteristics" , Section 4.4: "D²PAK package information" and Table 8: "Ordering information" .

IMPORTANT NOTICE – PLEASE READ CAREFULLY

STMicroelectronics NV and its subsidiaries ("ST") reserve the right to make changes, corrections, enhancements, modifications, and improvements to ST products and/or to this document at any time without notice. Purchasers should obtain the latest relevant information on ST products before placing orders. ST products are sold pursuant to ST's terms and conditions of sale in place at the time of order acknowledgement.

Purchasers are solely responsible for the choice, selection, and use of ST products and ST assumes no liability for application assistance or the design of Purchasers' products.

No license, express or implied, to any intellectual property right is granted by ST herein.

Resale of ST products with provisions different from the information set forth herein shall void any warranty granted by ST for such product.



ST and the ST logo are trademarks of ST. All other product or service names are the property of their respective owners.

Information in this document supersedes and replaces information previously supplied in any prior versions of this document.







© 2016 STMicroelectronics – All rights reserved

Looking for pricing, stock, or lifecycle information?

Click below to explore more details on WIN SOURCE:

-  [View STPS2045CG-TR on WIN SOURCE](#)
-  [STMicroelectronics Information](#)

Optimize Your Supply Chain with WIN SOURCE Solutions

-  Global Sourcing Solution
-  Obsolete Management
-  Cost Control Management
-  Shortage Management
-  Alternative Solution
-  Excess Inventory Management