



THE DATASHEET OF STPS15L30CB



Low drop power Schottky rectifier

Datasheet - production data

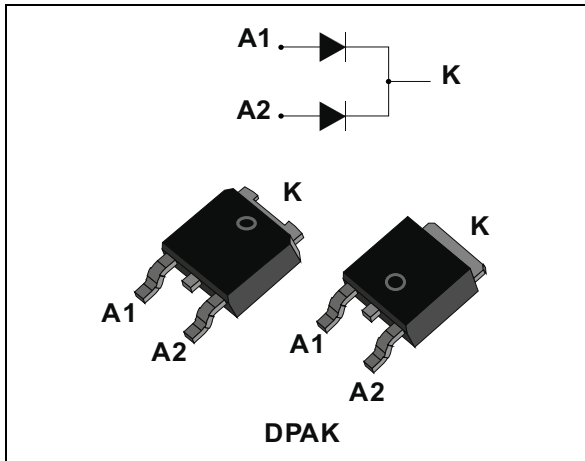

Description

Dual center tab Schottky rectifier suited for switched mode power supply and high frequency DC to DC converters.

Packaged in DPAK, this device is intended for use in low voltage, high frequency inverters, free-wheeling and polarity protection applications.

Table 1. Device summary

| Symbol | Value |
|-------------|-----------|
| $I_{F(AV)}$ | 2 x 7.5 A |
| V_{RRM} | 30 V |
| T_j | 150 °C |
| V_F (typ) | 0.34 V |

Features

- Very small conduction losses
- Negligible switching losses
- Extremely fast switching
- Low forward voltage drop
- Low capacitance
- Low thermal resistance
- Avalanche specification
- ECOPACK^{®2} compliant component for DPAK on demand

1 Characteristics

Table 2. Absolute ratings (limiting values per diode at 25 °C unless otherwise stated)

| Symbol | Parameter | | Value | Unit | |
|---------------------|---|--|---|------|---|
| V _{RRM} | Repetitive peak reverse voltage | | 30 | V | |
| I _{F(RMS)} | Forward rms current | | 10 | A | |
| I _{F(AV)} | Average forward current, $\delta = 0.5$, square wave | T _c = 140 °C ⁽¹⁾ | Per diode | 7.5 | A |
| | | | Per device | 15 | |
| I _{FSM} | Surge non repetitive forward current | | t _p = 10 ms sinusoidal | 75 | A |
| P _{ARM} | Repetitive peak avalanche power | | t _p = 10 μs, T _j = 125 °C | 200 | W |
| T _{stg} | Storage temperature range | | -65 to +175 | °C | |
| T _j | Maximum operating junction temperature ⁽²⁾ | | 150 | °C | |

- Value based on R_{th(j-c)} max (per diode)
- $\frac{dP_{tot}}{dT_j} < \frac{1}{R_{th(j-a)}}$ condition to avoid thermal runaway for a diode on its own heatsink

Table 3. Thermal resistances

| Symbol | Parameter | | Value | Unit |
|----------------------|------------------|-----------|-------|------|
| R _{th(j-c)} | Junction to case | Per diode | 4 | °C/W |
| | | Total | 2.4 | |
| R _{th(c)} | Coupling | | 0.7 | |

When the diodes 1 and 2 are used simultaneously:

$$\Delta T_j(\text{diode } 1) = P(\text{diode } 1) \times R_{th(j-c)}(\text{Per diode}) + P(\text{diode } 2) \times R_{th(c)}$$

Table 4. Static electrical characteristics (per diode)

| Symbol | Parameter | Test Conditions | | Min. | Typ. | Max. | Unit |
|-------------------------------|-------------------------|-------------------------|-----------------------------------|------|------|------|------|
| I _R ⁽¹⁾ | Reverse leakage current | T _j = 25 °C | V _R = V _{RRM} | | | 1 | mA |
| | | T _j = 125 °C | | | 70 | 140 | mA |
| V _F ⁽²⁾ | Forward voltage drop | T _j = 25 °C | I _F = 7.5 A | | | 0.48 | V |
| | | T _j = 125 °C | I _F = 7.5 A | | 0.34 | 0.39 | |
| | | T _j = 25 °C | I _F = 12 A | | | 0.53 | |
| | | T _j = 125 °C | I _F = 12 A | | 0.40 | 0.47 | |
| | | T _j = 25 °C | I _F = 15 A | | | 0.57 | |
| | | T _j = 125 °C | I _F = 15 A | | 0.44 | 0.51 | |

- Pulse test: t_p = 5 ms, δ < 2%
- Pulse test: t_p = 380 μs, δ < 2%

To evaluate the conduction losses use the following equation:

$$P = 0.27 \times I_{F(AV)} + 0.016 I_{F(RMS)}^2$$

Figure 1. Average forward power dissipation versus average forward current (per diode)

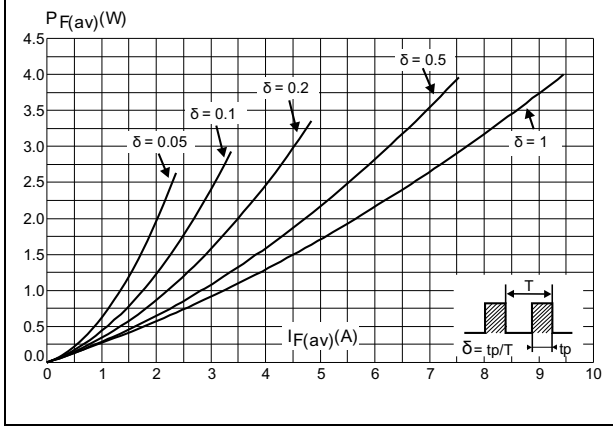

Figure 2. Average forward current versus ambient temperature ($\delta = 0.5$)(per diode)

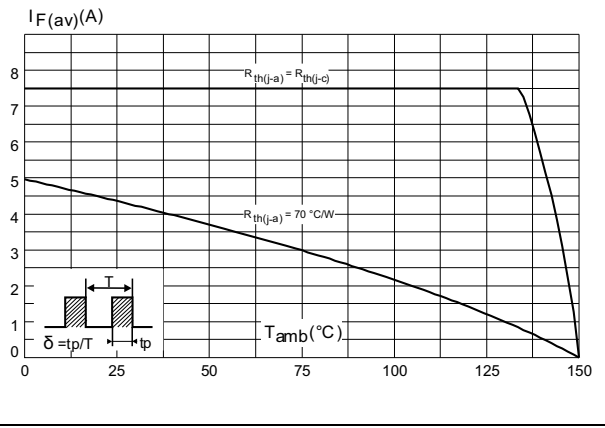

Figure 3. Normalized avalanche power derating versus pulse duration at $T_j = 125\text{ }^\circ\text{C}$

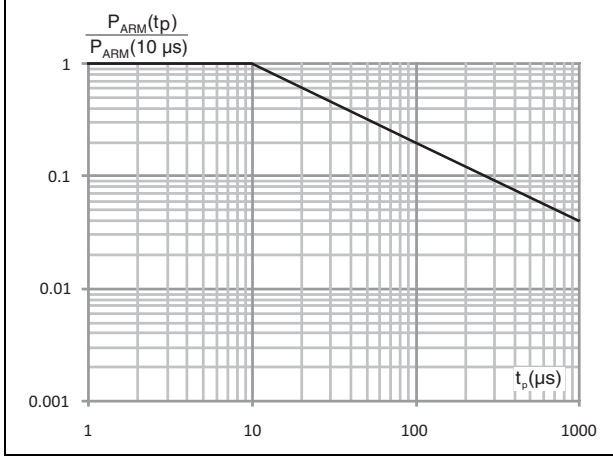

Figure 4. Relative variation of thermal impedance junction to case versus pulse duration

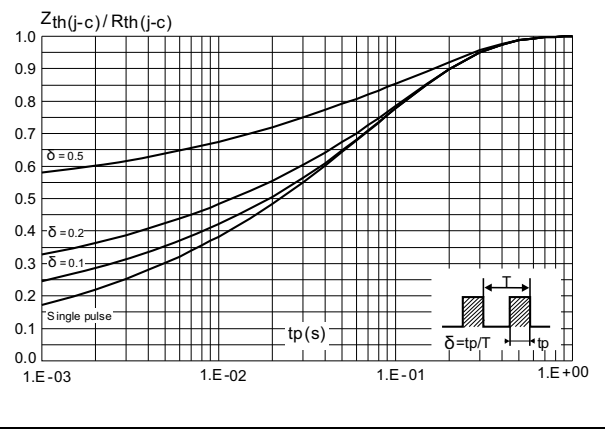

Figure 5. Reverse leakage current versus reverse voltage applied (typical values, per diode)

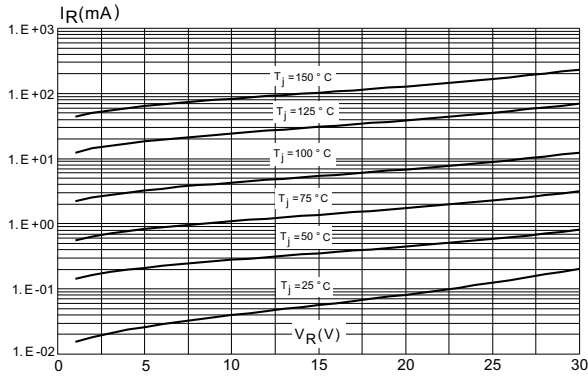

Figure 6. Junction capacitance versus reverse voltage applied (typical values, per diode)

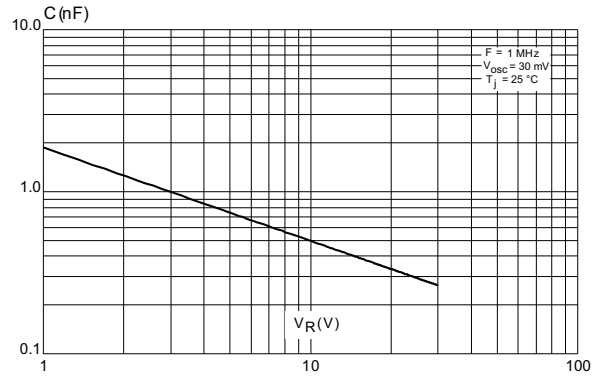

Figure 7. Forward voltage drop versus forward current (per diode)

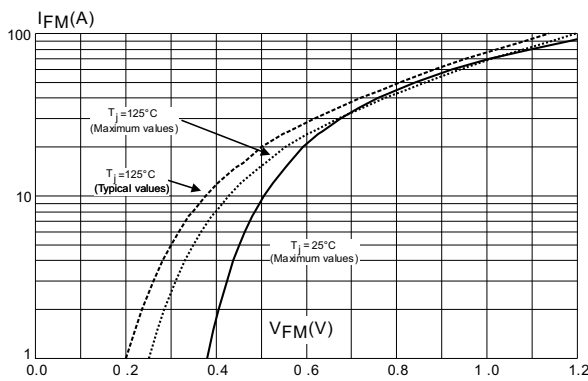
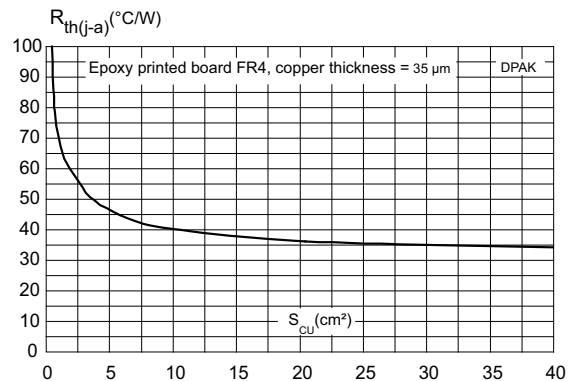

Figure 8. Thermal resistance junction to ambient versus copper surface under tab



2 Package Information

- Epoxy meets UL94,V0
- Cooling method: by conduction (C)

In order to meet environmental requirements, ST offers these devices in different grades of ECOPACK® packages, depending on their level of environmental compliance. ECOPACK® specifications, grade definitions and product status are available at: www.st.com. ECOPACK® is an ST trademark.

2.1 DPAK package information

Figure 9. DPAK package outline

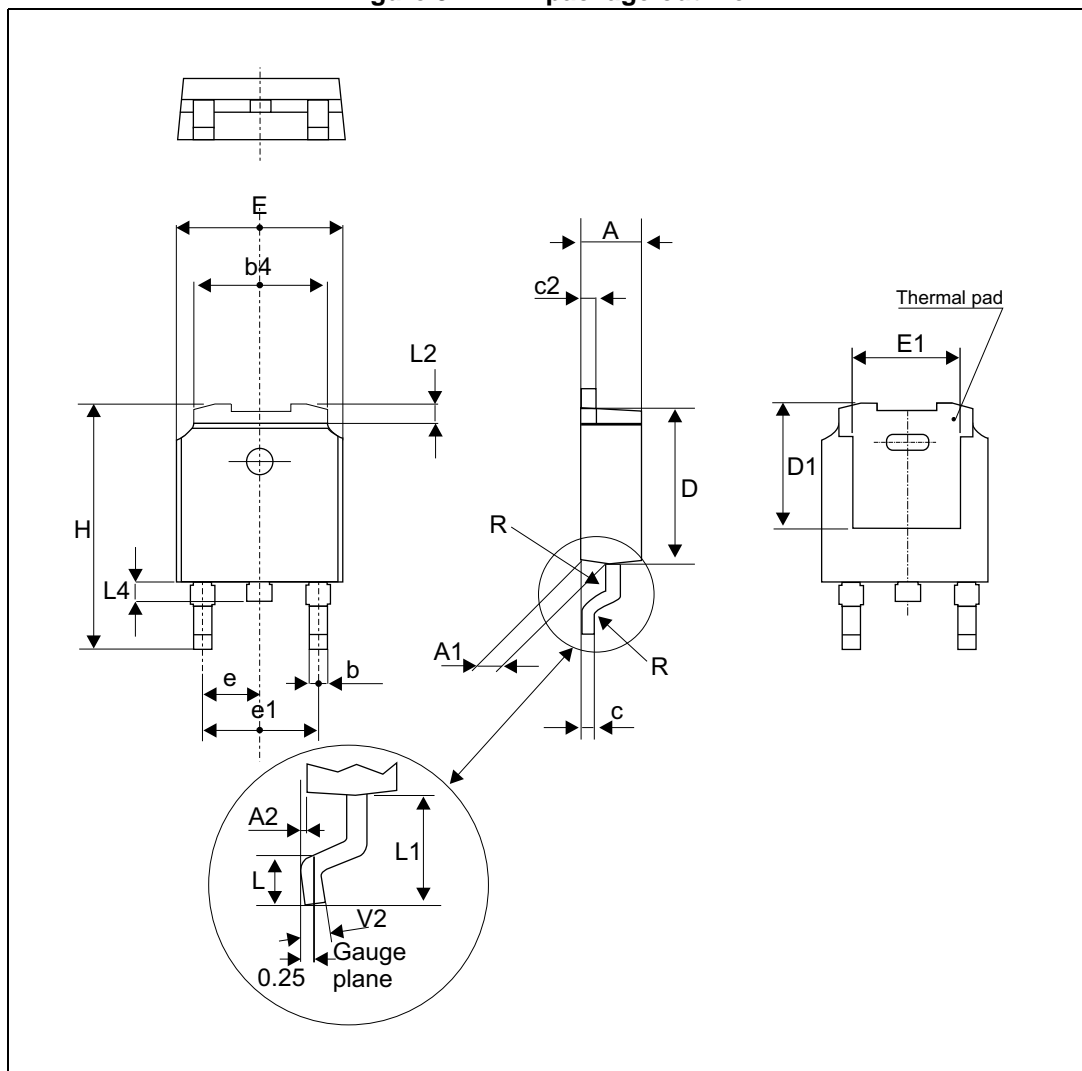

Note: This package drawing may slightly differ from the physical package. However, all the specified dimensions are guaranteed.

Table 5. DPAK package mechanical data

| Ref. | Dimensions | | | | | |
|------|-------------|------|-------|--------|-------|-------|
| | Millimeters | | | Inches | | |
| | Min. | Typ. | Max. | Min. | Typ. | Max. |
| A | 2.18 | | 2.40 | 0.085 | | 0.094 |
| A1 | 0.90 | | 1.10 | 0.035 | | 0.043 |
| A2 | 0.03 | | 0.23 | 0.001 | | 0.009 |
| b | 0.64 | | 0.90 | 0.025 | | 0.035 |
| b4 | 4.95 | | 5.46 | 0.194 | | 0.214 |
| c | 0.46 | | 0.61 | 0.018 | | 0.024 |
| c2 | 0.46 | | 0.60 | 0.018 | | 0.023 |
| D | 5.97 | | 6.22 | 0.235 | | 0.244 |
| D1 | 4.95 | | 5.60 | 0.194 | | 0.220 |
| E | 6.35 | | 6.73 | 0.250 | | 0.264 |
| E1 | 4.32 | | 5.50 | 0.170 | | 0.216 |
| e | | 2.28 | | | 0.090 | |
| e1 | 4.40 | | 4.70 | 0.173 | | 0.185 |
| H | 9.35 | | 10.40 | 0.368 | | 0.409 |
| L | 1.00 | | 1.78 | 0.039 | | 0.070 |
| L2 | | | 1.27 | | | 0.050 |
| L4 | 0.60 | | 1.02 | 0.023 | | 0.040 |
| V2 | -8° | | +8° | -8° | | 8° |

Figure 10. DPAK footprint dimensions (in mm)

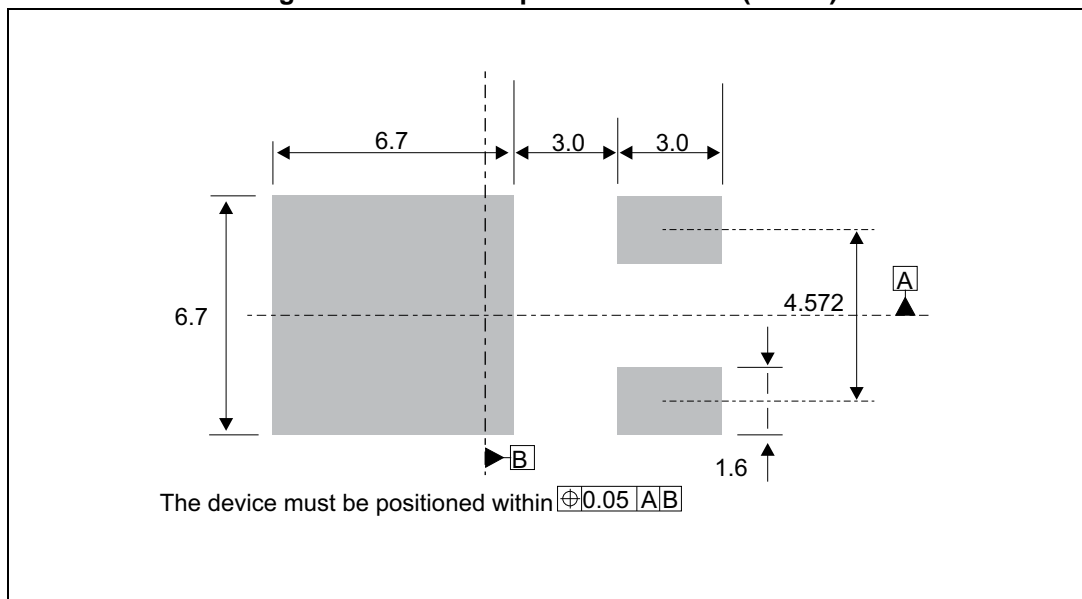

3 Ordering Information

Table 6. Ordering information

| Order code | Marking | Package | Weight | Base qty | Delivery mode |
|----------------|---------|---------|--------|----------|---------------|
| STPS15L30CB | S15L30C | DPAK | 0.30 g | 75 | Tube |
| STPS15L30CB-TR | S15L30C | DPAK | 0.30 g | 2500 | Tape and reel |

4 Revision history

Table 7. Document revision history

| Date | Revision | Description of Changes |
|-------------|----------|---|
| 14-Jun-2012 | 2 | Automatic revalidation date workflow started. |
| 21-Oct-2014 | 3 | Updated DPAK package information and reformatted to current standard. Removed IPAK. |
| 18-Dec-2015 | 4 | Updated DPAK package information and reformatted to current standard. |

IMPORTANT NOTICE – PLEASE READ CAREFULLY

STMicroelectronics NV and its subsidiaries ("ST") reserve the right to make changes, corrections, enhancements, modifications, and improvements to ST products and/or to this document at any time without notice. Purchasers should obtain the latest relevant information on ST products before placing orders. ST products are sold pursuant to ST's terms and conditions of sale in place at the time of order acknowledgement.

Purchasers are solely responsible for the choice, selection, and use of ST products and ST assumes no liability for application assistance or the design of Purchasers' products.

No license, express or implied, to any intellectual property right is granted by ST herein.

Resale of ST products with provisions different from the information set forth herein shall void any warranty granted by ST for such product.



ST and the ST logo are trademarks of ST. All other product or service names are the property of their respective owners.

Information in this document supersedes and replaces information previously supplied in any prior versions of this document.

© 2015 STMicroelectronics – All rights reserved

Looking for pricing, stock, or lifecycle information?

Click below to explore more details on WIN SOURCE:

-  [View STPS15L30CB on WIN SOURCE](#)
-  [STMicroelectronics Information](#)

Optimize Your Supply Chain with WIN SOURCE Solutions

-  Global Sourcing Solution
-  Obsolete Management
-  Cost Control Management
-  Shortage Management
-  Alternative Solution
-  Excess Inventory Management