



**THE DATASHEET OF
STM1061N29WX6F**



Low Power Voltage Detector

Features

- Factory-trimmed Voltage Thresholds in 0.1V Increments from 1.6 to 5.5V
- $\pm 2\%$ Voltage Threshold Accuracy
- Operating Voltage 0.7 to 6.0V
- Open Drain Output
- Low Supply Current of 0.9 μ A (typ)
- Guaranteed $\overline{\text{OUT}}$ Assertion Down to $V_{\text{CC}} = 0.7\text{V}$
- Power Supply Transient Immunity
- Available in SOT23-3 and SOT323-3 (SC70-3) packages
- Operating Temperature -40 to 85°C .

Figure 1. Packages

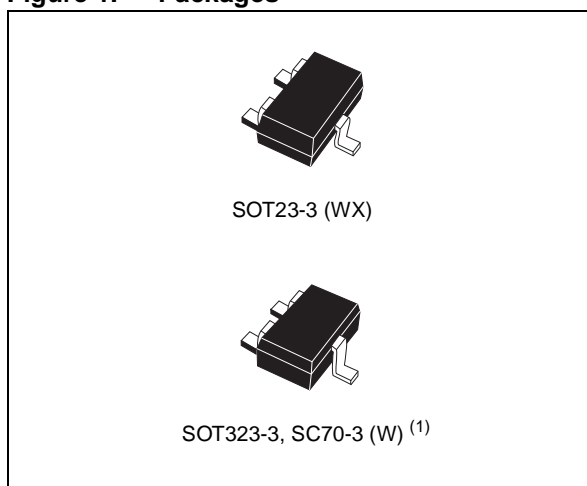

1. Contact local sales office for availability.

Contents

1	Summary Description	5
2	Pin Descriptions	7
2.1	OUT (Open Drain)	7
2.2	V _{CC}	7
2.3	V _{SS}	7
3	Operation	8
3.1	Output	8
3.2	Negative-Going V _{CC} Transients and Undershoot	8
4	Typical Operating Characteristics	9
5	Maximum Rating	13
6	DC and AC Parameters	14
7	Package Mechanical	17
8	Part Numbering	20
9	Revision History	22

List of tables

Table 1.	Signal Names	5
Table 2.	Pin Functions	7
Table 3.	Absolute Maximum Ratings	13
Table 4.	Operating and AC Measurement Conditions	14
Table 5.	DC and AC Characteristics	16
Table 6.	SOT23-3 – 3-lead Small Outline Transistor Package Mechanical Data	18
Table 7.	SOT323-3 (SC70-3) – 3-lead Small Outline Transistor Package Mechanical Data	19
Table 8.	Ordering Information Scheme	20
Table 9.	Factory-Trimmed Thresholds with Marking Description	21
Table 10.	Document Revision History	22

List of figures

Figure 1.	Packages	1
Figure 2.	Logic Diagram	5
Figure 3.	SOT23-3 Connections	5
Figure 4.	SOT323-3 (SC70-3) Connections	6
Figure 5.	N-Channel Open Drain Output Block Diagram	6
Figure 6.	STM1061N Active-Low, Open Drain Hardware Hookup	6
Figure 7.	Supply Current vs. Input Voltage	9
Figure 8.	Supply Current vs. Ambient Temperature	9
Figure 9.	Output Detect Delay Time vs. Ambient Temperature	10
Figure 10.	Output Release Delay Time vs. Ambient Temperature	10
Figure 11.	Maximum Transient Duration vs. Reset Threshold Overdrive	11
Figure 12.	Detect, Release Voltage vs. Ambient Temperature for $V_{TH-} = 3.4V$	11
Figure 13.	N-channel Driver Output Current vs. V_{DS}	12
Figure 14.	N-channel Driver Output Current vs. Input Voltage for $V_{DS} = 0.5V$	12
Figure 15.	AC Testing Input/Output Waveforms	14
Figure 16.	Voltage Timing Waveform	15
Figure 17.	SOT23-3 – 3-lead Small Outline Transistor Package Outline	17
Figure 18.	SOT323-3 (SC70-3) – 3-lead Small Outline Transistor Package Outline	19

1 Summary Description

The STM1061 low power voltage detector provides monitoring of battery, power-supply, and regulated system voltages. A precision voltage reference and comparator monitors the V_{CC} input and compares it with a specified voltage threshold condition. When V_{CC} falls below a specified trip point threshold, the output (\overline{OUT}) is forced low and remains asserted as long as the V_{CC} input remains below $V_{TH-} + \text{hysteresis}$ (V_{HYST}). The STM1061 device is guaranteed to output the correct logic state for V_{CC} down to 0.7V. They are also designed to ignore fast transients on V_{CC} .

This small, low power device is ideal for portable applications and is available in space-saving SOT23-3 and SOT323-3 (SC70-3) packages.

Figure 2. Logic Diagram

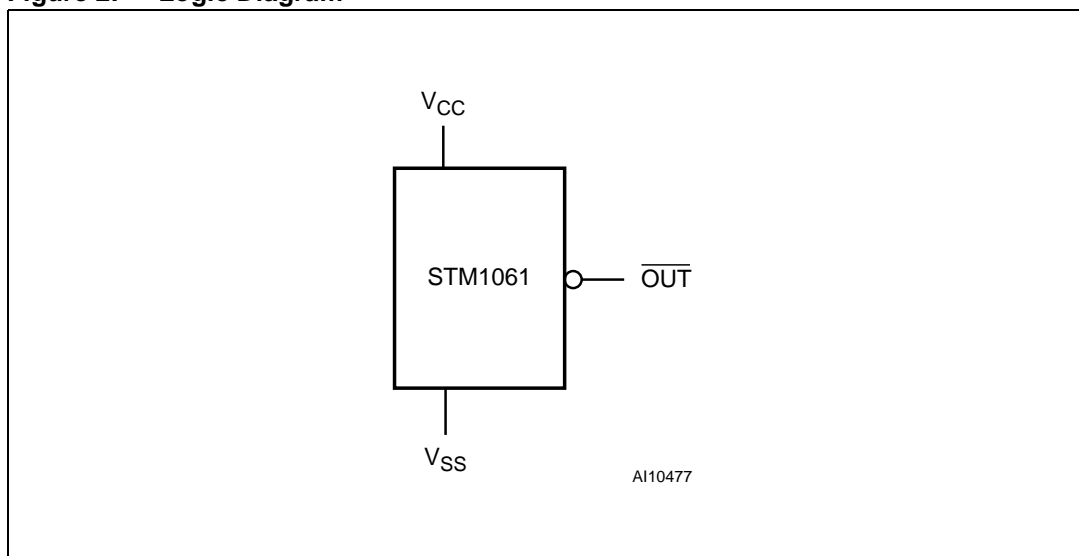

Table 1. Signal Names

OUT	Open Drain Active-Low Output
V_{CC}	Supply Voltage
V_{SS}	Ground

Figure 3. SOT23-3 Connections

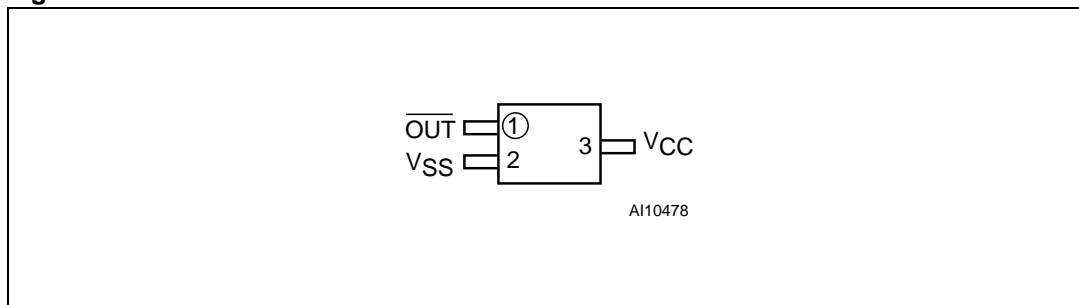

Figure 4. SOT323-3 (SC70-3) Connections

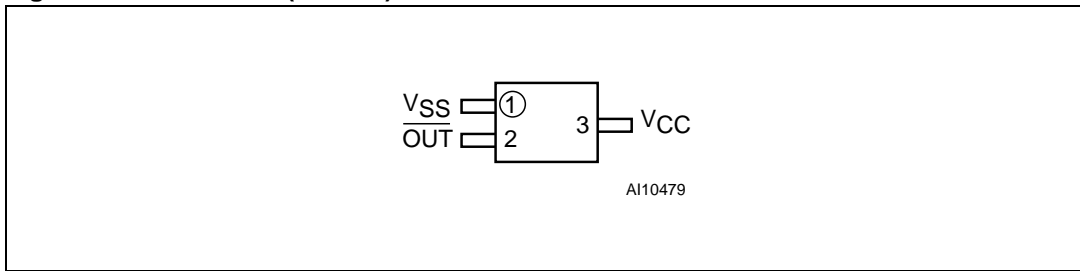

Figure 5. N-Channel Open Drain Output Block Diagram

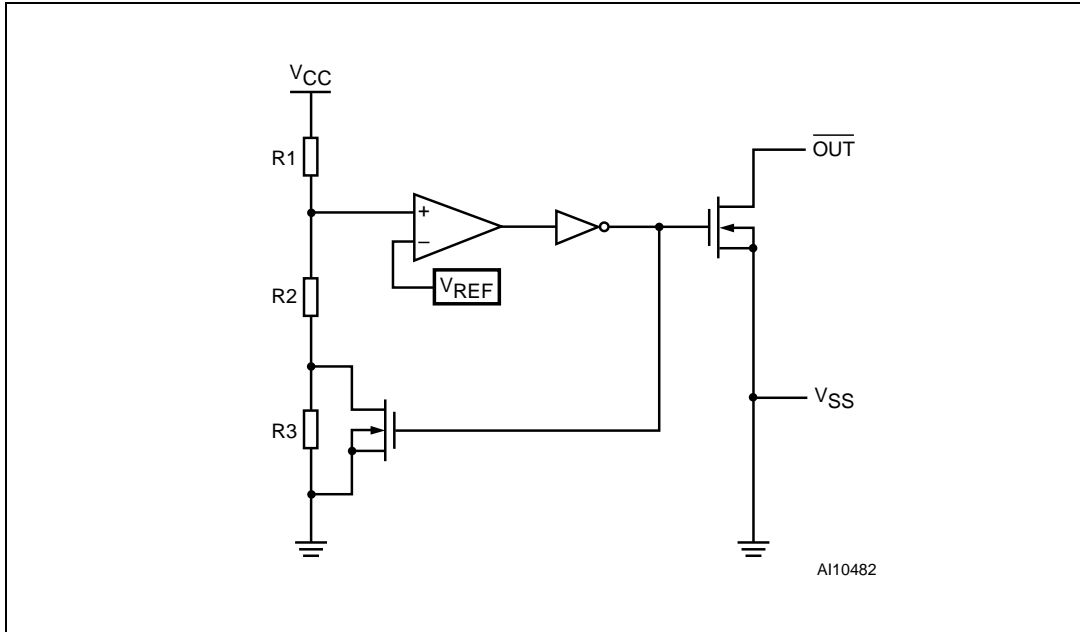
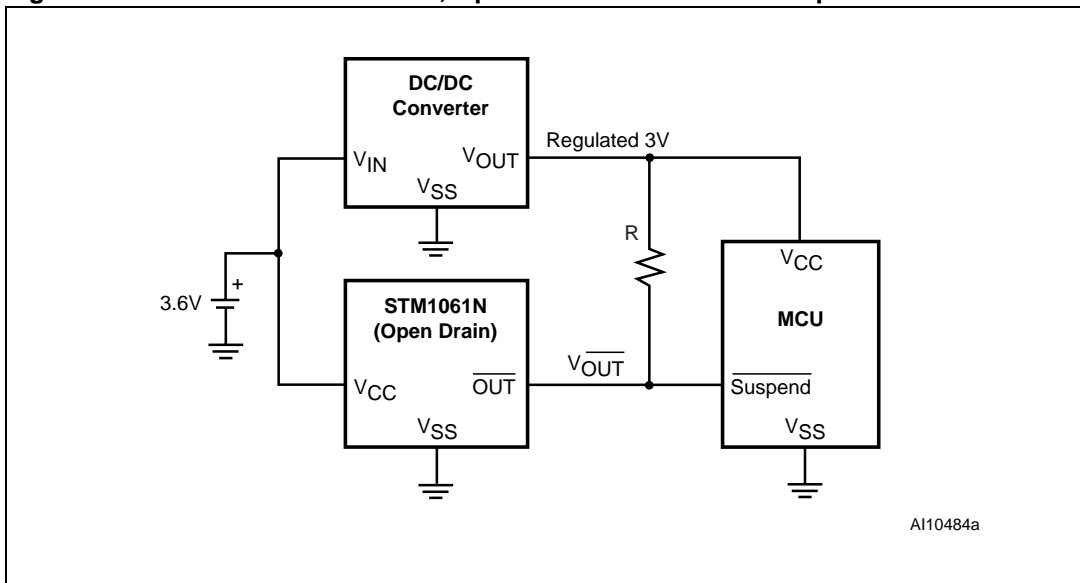

Figure 6. STM1061N Active-Low, Open Drain Hardware Hookup



2 Pin Descriptions

See [Figure 2 on page 5](#) and [Table 1 on page 5](#) for a brief overview of the signals connected to this device.

2.1 $\overline{\text{OUT}}$ (Open Drain)

This is the Open Drain Output. It goes low when V_{CC} drops below V_{TH-} , and remains low as long as V_{CC} is below $V_{TH-} + V_{HYST}$.

2.2 V_{CC}

This is the Supply voltage and input for the Voltage Detector.

2.3 V_{SS}

Ground, V_{SS} , is the reference for the power supply. It must be connected to the system ground.

Table 2. Pin Functions

Pin		Name	Function
SOT23-3	SOT323-3 (SC70-3)		
1	2	OUT	Active-Low Open Drain Output
3	3	V_{CC}	Supply Voltage
2	1	V_{SS}	Ground

3 Operation

3.1 Output

The STM1061 Voltage Detector monitors system voltages from 1.6 to 5V in 100mV increments. The detector is designed to ignore fast transients on V_{CC} and has a voltage hysteresis (V_{HYST}). The STM1061 asserts an output signal (\overline{OUT}) whenever V_{CC} goes below the Voltage Detect Threshold (V_{TH-}). The output signal (\overline{OUT}) stays asserted until V_{CC} goes above the Voltage Detect Release (V_{TH+}). Output voltage ($V_{\overline{OUT}}$) is guaranteed valid down to $V_{CC} = 0.7V$ at 25°C.

The STM1061 has an open drain active-low output which will sink current when output is asserted. Connect a pull-up resistor from \overline{OUT} to any supply voltage up to 6V (see [Figure 6 on page 6](#)). Select a resistor value large enough to register a logic low, and small enough to register a logic high while all of the input current and leakage paths connected to the reset output line are being supplied. A 10k pull-up is sufficient in most applications.

The advantages of open drain output is the ability to connect more open drain outputs in parallel (wired OR connections) as well as connect the output to a power supply voltage different from V_{CC} .

3.2 Negative-Going V_{CC} Transients and Undershoot

The STM1061 device is relatively immune to negative-going V_{CC} transients (glitches). The graph (see [Figure 11 on page 11](#)) indicates the maximum pulse width a negative V_{CC} transient can have without causing a reset pulse. As the magnitude of the transient increases (further below the threshold), the maximum allowable pulse width decreases. Any combination of duration and overdrive which lies under the curve will NOT generate a reset signal.

A 0.1 μ F bypass capacitor mounted as close as possible to the V_{CC} pin provides additional transient immunity.

4 Typical Operating Characteristics

Figure 7. Supply Current vs. Input Voltage

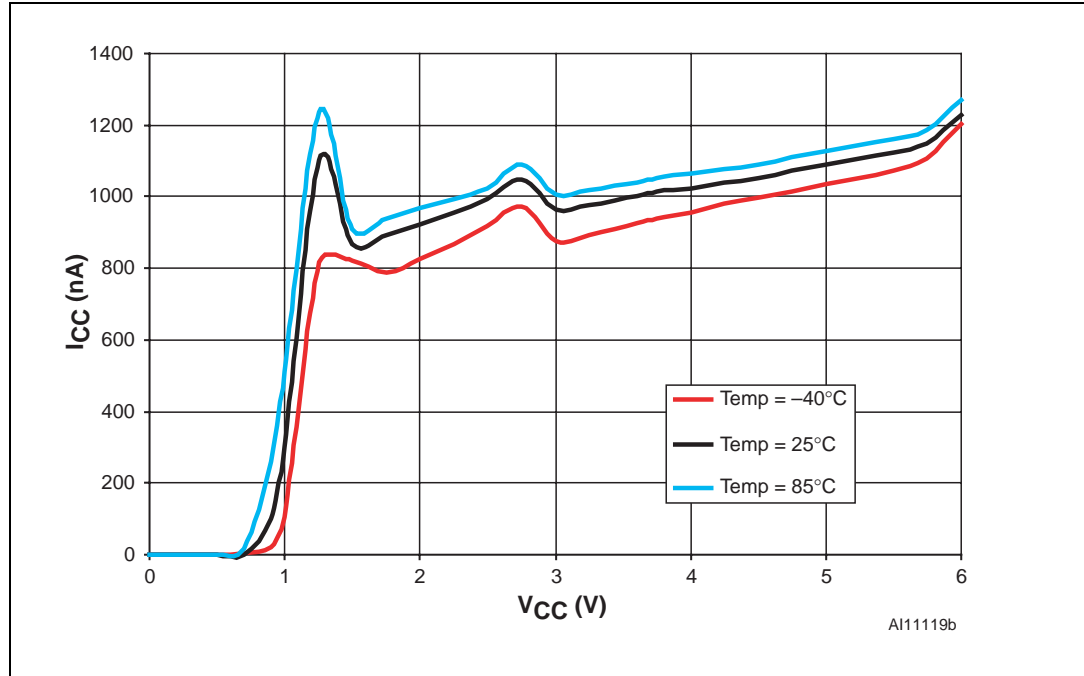

Figure 8. Supply Current vs. Ambient Temperature

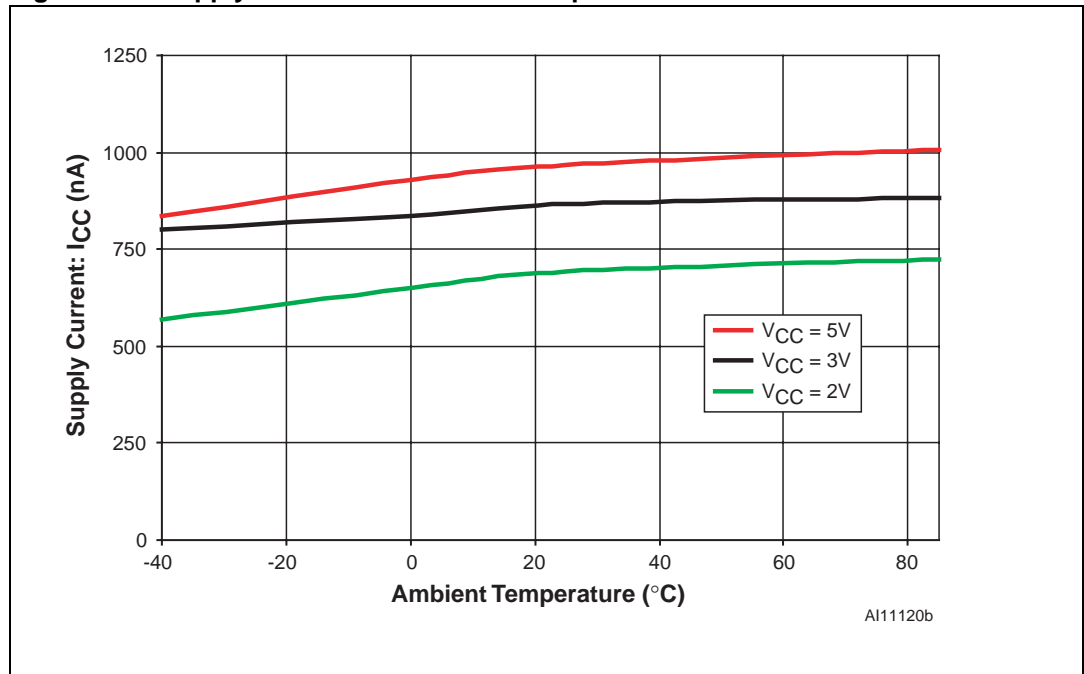

Figure 9. Output Detect Delay Time vs. Ambient Temperature

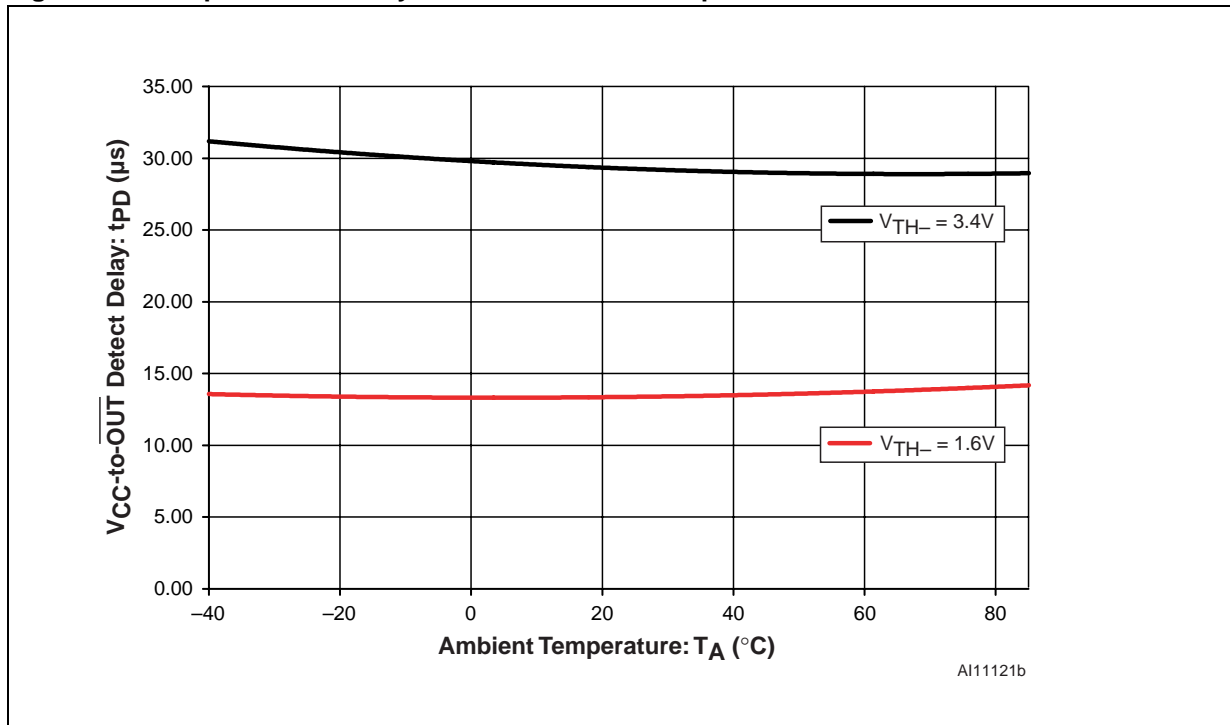

Figure 10. Output Release Delay Time vs. Ambient Temperature

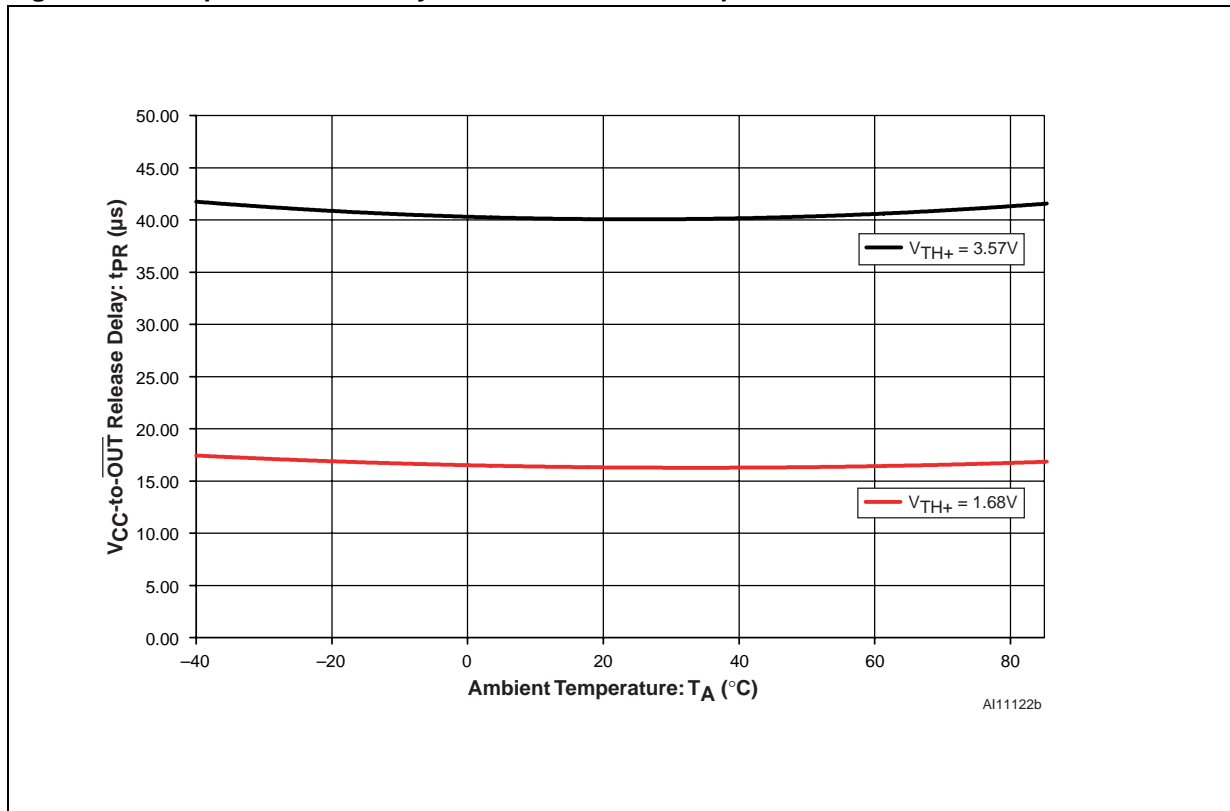
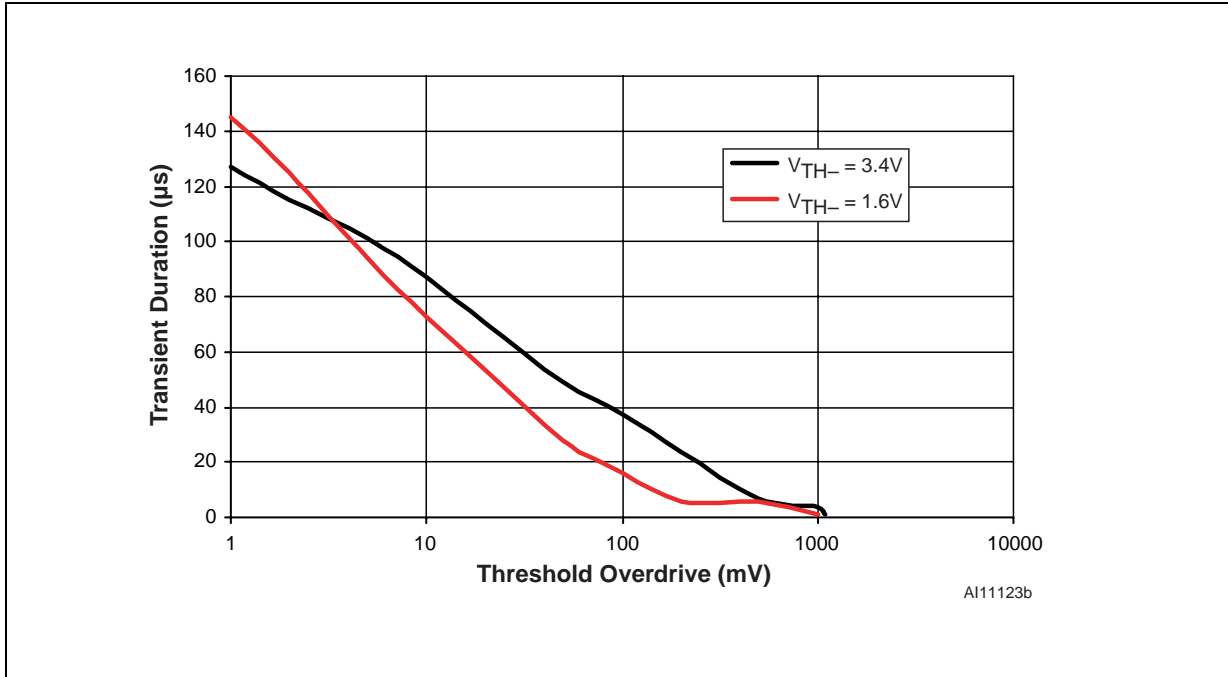

Figure 11. Maximum Transient Duration vs. Reset Threshold Overdrive



1. Reset occurs above the curve.

Figure 12. Detect, Release Voltage vs. Ambient Temperature for $V_{TH-} = 3.4V$

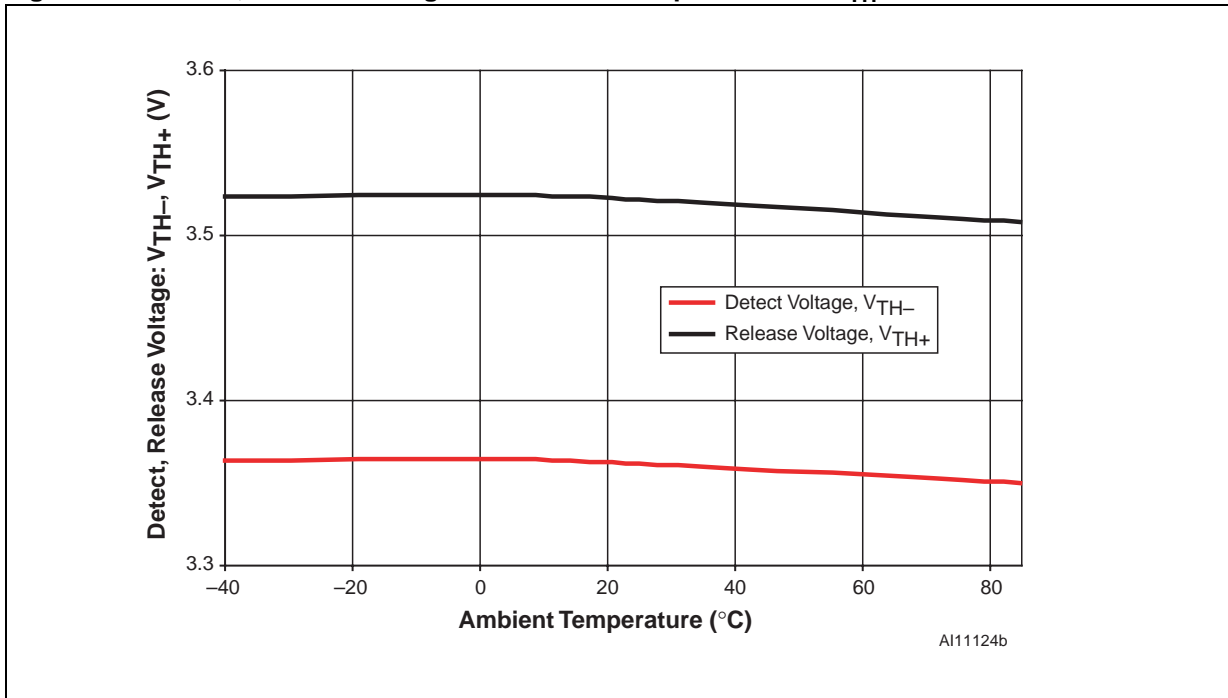

Figure 13. N-channel Driver Output Current vs. V_{DS}

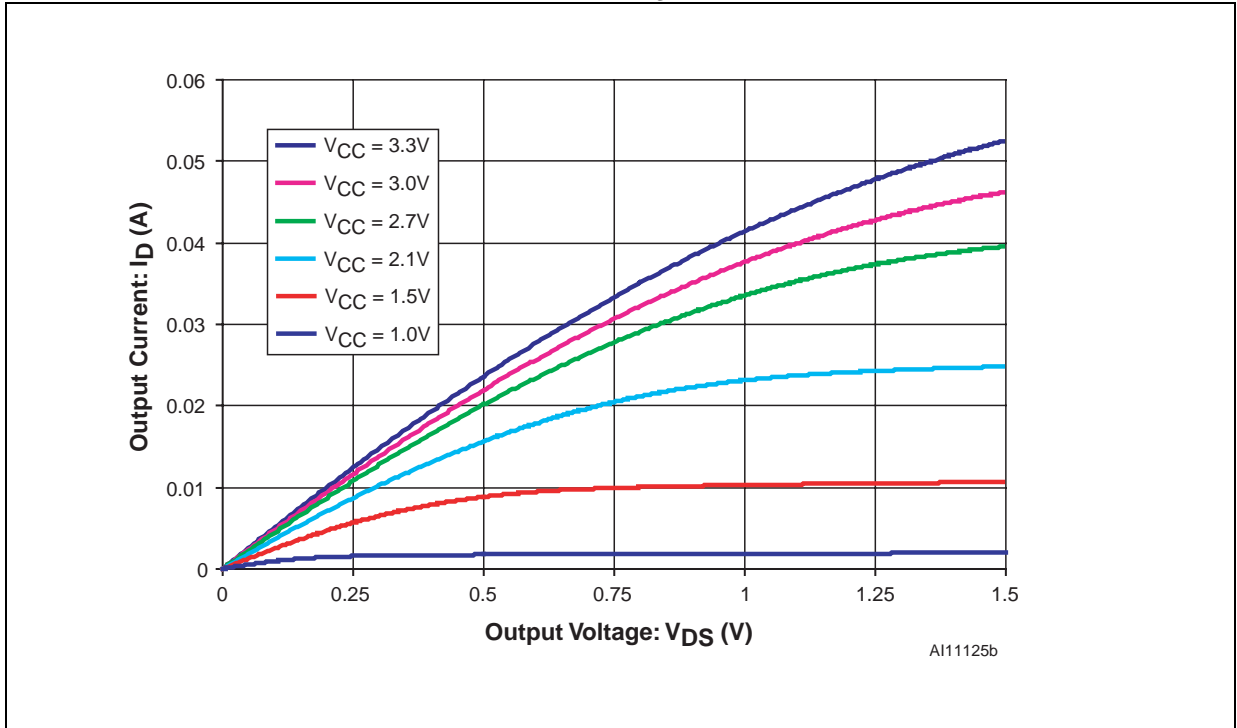
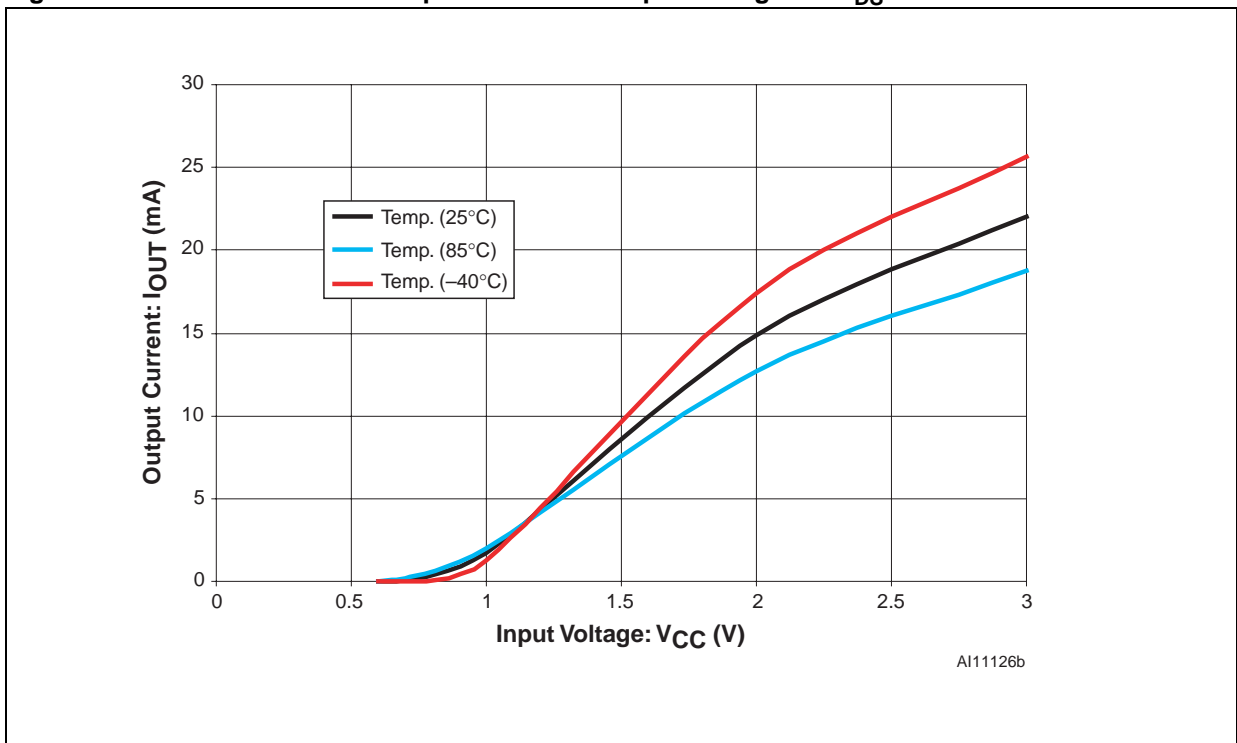

Figure 14. N-channel Driver Output Current vs. Input Voltage for $V_{DS} = 0.5V$



5 Maximum Rating

Stressing the device above the rating listed in the [Table 3: Absolute Maximum Ratings](#) may cause permanent damage to the device. These are stress ratings only and operation of the device at these or any other conditions above those indicated in the Operating sections of this specification is not implied. Exposure to Absolute Maximum Rating conditions for extended periods may affect device reliability. Refer also to the STMicroelectronics SURE Program and other relevant quality documents.

Table 3. Absolute Maximum Ratings

Symbol	Parameter	Value	Unit
T_{STG}	Storage Temperature (V_{CC} Off, V_{BAT} Off)	-55 to 150	°C
$T_{SLD}^{(1)}$	Lead Solder Temperature for 10 seconds	260	°C
V_{IO}	Input or Output Voltage	-0.3 to $V_{CC} + 0.3$	V
V_{CC}	Supply Voltage	-0.3 to 7.0	V
I_O	Output Current	20	mA
P_D	Power Dissipation	320	mW

1. Reflow at peak temperature of 260°C (total thermal budget not to exceed 245°C for greater than 30 seconds).

6 DC and AC Parameters

This section summarizes the operating measurement conditions, and the DC and AC characteristics of the device. The parameters in the DC and AC characteristics Tables that follow, are derived from tests performed under the Measurement Conditions summarized in [Table 4: Operating and AC Measurement Conditions](#). Designers should check that the operating conditions in their circuit match the operating conditions when relying on the quoted parameters.

Table 4. Operating and AC Measurement Conditions

Sym	Parameter	STM1061	Unit
V_{CC}	Supply Voltage	0.7 to 6.0	V
T_A	Ambient Operating Temperature	-40 to 85	°C
	Input Rise and Fall Times	≤ 5	ns
	Input Pulse Voltages	0.2 to $0.8V_{CC}$	V
	Input and Output Timing Ref. Voltages	0.3 to $0.7V_{CC}$	V

Figure 15. AC Testing Input/Output Waveforms

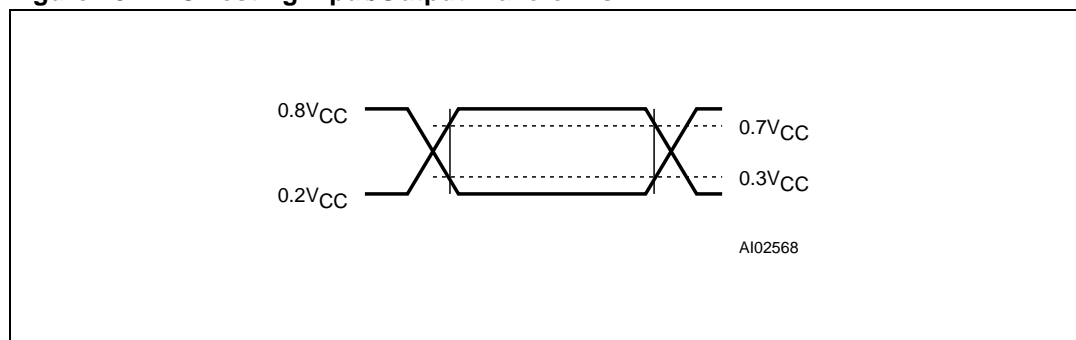

Figure 16. Voltage Timing Waveform

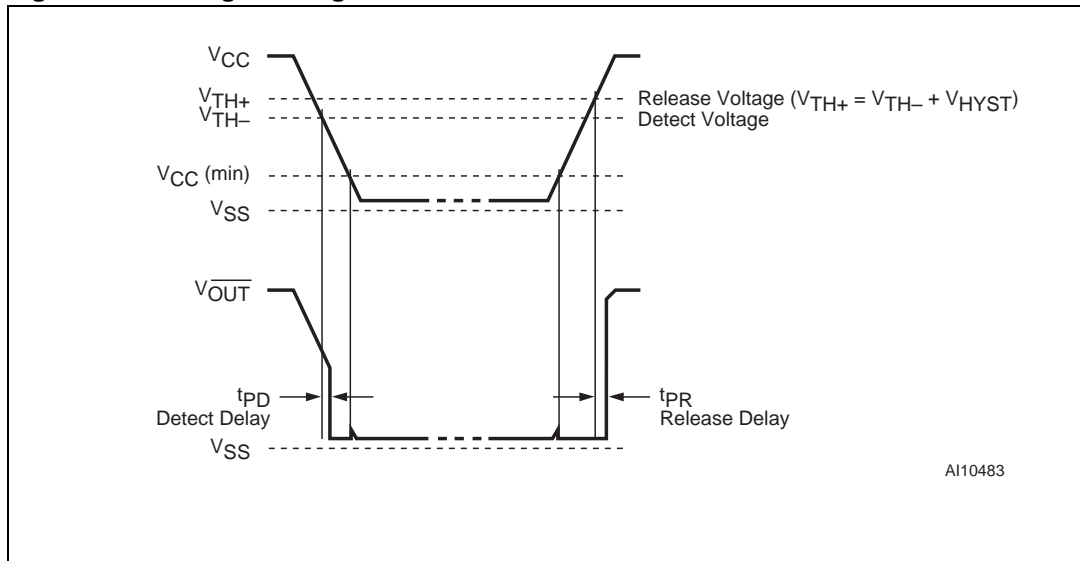

Table 5. DC and AC Characteristics

Sym.	Description	Test Condition ⁽¹⁾	Min	Typ	Max	Unit
V _{CC}	Operating Voltage		0.7		6.0	V
I _{CC}	V _{CC} Supply Current	V _{CC} = 3.0V, No Load		0.9	3.0	μA
		V _{CC} = 5.5V, No Load		1.1	3.6	μA
I _{OUT}	Output Current, N-channel (V _{DS} = 0.5V), Reset asserted	V _{CC} = 1.0V	1.0	1.7		mA
		V _{CC} = 2.0V	3.0	14		mA
		V _{CC} = 3.0V	5.0	22		mA
		V _{CC} = 4.0V	6.0	26		mA
		V _{CC} = 5.0V	7.0	30		mA
Voltage Thresholds						
V _{TH-}	Detect Voltage ⁽²⁾ (see Table 9 on page 21 for detailed listing)		V _{TH-} - 2%	V _{TH-}	V _{TH-} + 2%	V
V _{TH+}	Release Voltage			V _{TH-} + V _{HYST}		V
V _{HYST}	Threshold Hysteresis		0.02V _{TH-}	0.05V _{TH-}	0.08V _{TH-}	V
t _{PD}	V _{CC} to $\overline{\text{OUT}}$ Detect Delay	V _{CC} falling from (V _{TH-} + 100mV) to (V _{TH-} - 100mV) at 10mV/μs		25		μs
t _{PR}	V _{CC} to $\overline{\text{OUT}}$ Release Delay	V _{CC} rising from (V _{TH+} - 100mV) to (V _{TH+} + 100mV) at 10mV/μs		30	200	μs
	Threshold Temperature Coefficient			±100		ppm/°C

1. Valid for Ambient Operating Temperature: T_A = 25°C.

2. Other V_{TH-} threshold are offered. Minimum order quantities may apply. Contact local sales office for availability.

7 Package Mechanical

In order to meet environmental requirements, ST offers these devices in ECOPACK[®] packages. These packages have a Lead-free second level interconnect. The category of second Level Interconnect is marked on the package and on the inner box label, in compliance with JEDEC Standard JESD97.

The maximum ratings related to soldering conditions are also marked on the inner box label. ECOPACK is an ST trademark. ECOPACK specifications are available at: www.st.com.

Figure 17. SOT23-3 – 3-lead Small Outline Transistor Package Outline

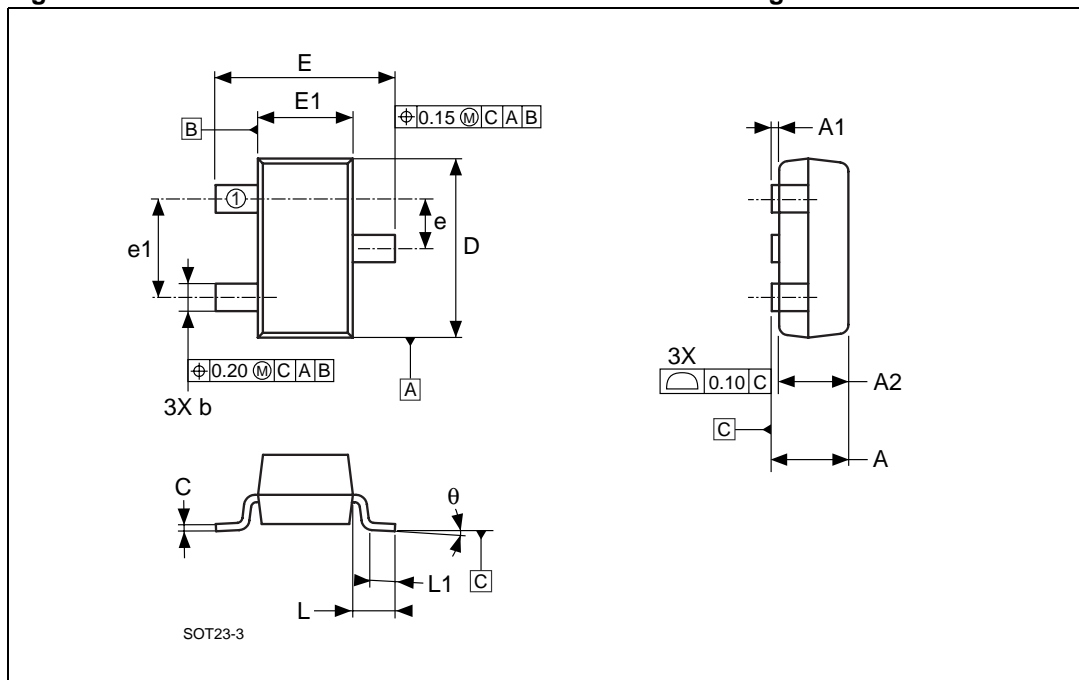

1. Drawing is not to scale.

Table 6. SOT23-3 – 3-lead Small Outline Transistor Package Mechanical Data

Symbol	mm			inches		
	Typ	Min	Max	Typ	Min	Max
A		0.89	1.12		0.035	0.044
A1		0.01	0.10		0.001	0.004
A2		0.88	1.02		0.035	0.042
b		0.30	0.50		0.012	0.020
C		0.08	0.20		0.003	0.008
D		2.80	3.04		0.110	0.120
E		2.10	2.64		0.083	0.104
E1		1.20	1.40		0.047	0.055
e		0.89	1.03		0.035	0.041
e1		1.78	2.05		0.070	0.081
L	0.54			0.021		
L1		0.40	0.60		0.016	0.024
Q		0°	8°		0°	8°
N		3			3	

Figure 18. SOT323-3 (SC70-3) – 3-lead Small Outline Transistor Package Outline

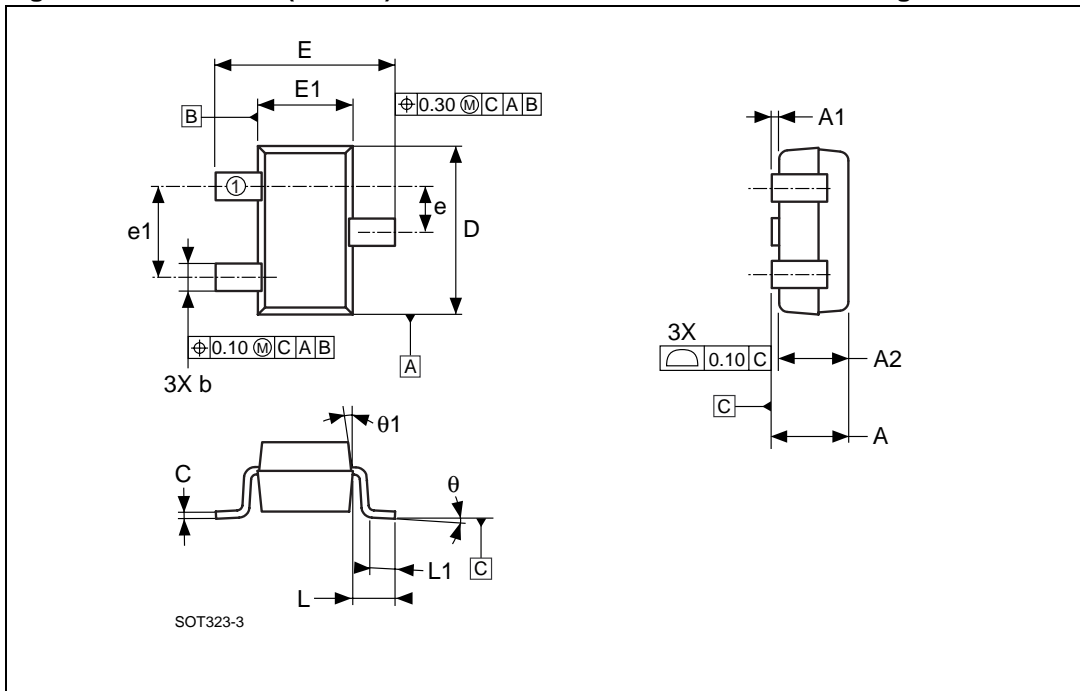

1. Drawing is not to scale.

Table 7. SOT323-3 (SC70-3) – 3-lead Small Outline Transistor Package Mechanical Data

Symbol	mm			inches			
	Typ	Min	Max	Typ	Min	Max	
A		0.80	1.10		0.031	0.043	
A1		0.00	0.10		0.000	0.004	
A2		0.80	1.00		0.031	0.039	
b		0.25	0.40		0.010	0.016	
C		0.10	0.18		0.004	0.007	
D		1.80	2.20		0.071	0.087	
E		1.80	2.40		0.071	0.094	
E1		1.15	1.35		0.045	0.053	
e		0.65			0.026		
e1		1.30			0.051		
L		0.35	0.45		0.014	0.018	
L1		0.10	0.30		0.004	0.012	
Q		0°	30°		0°	30°	
Θ1		8°	12°		8°	12°	
N		3				3	

8 Part Numbering

Table 8. Ordering Information Scheme

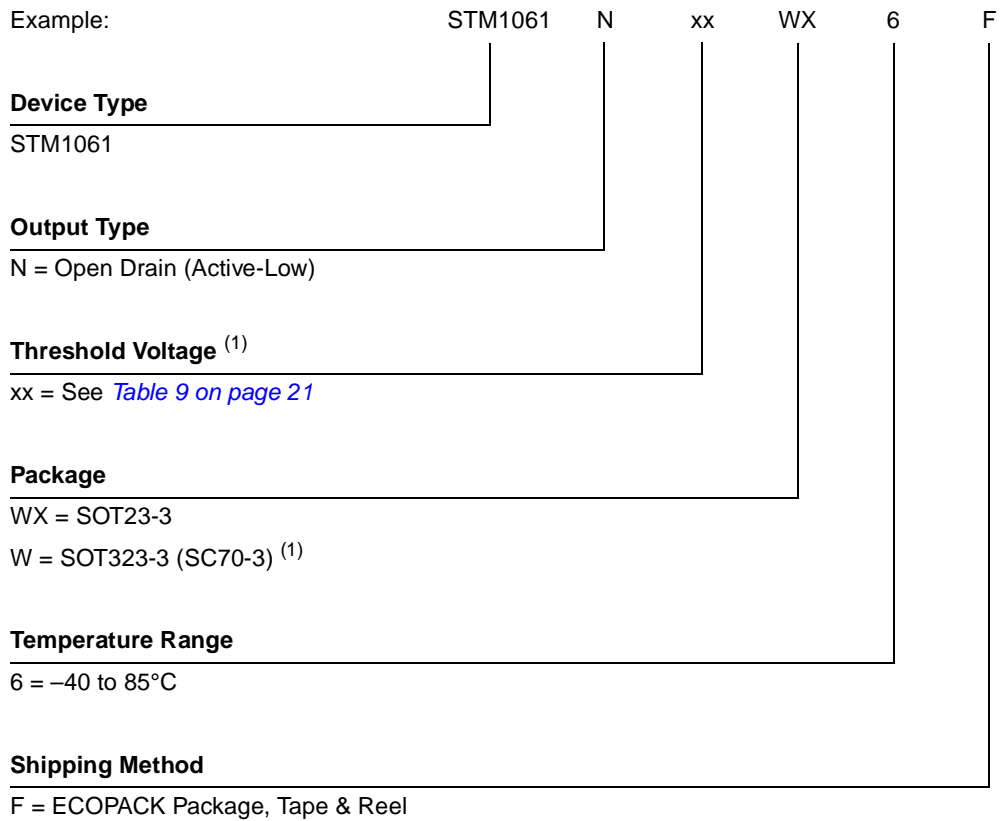

1. Other thresholds voltage options are offered. Minimum order quantities may apply. Contact local sales office for availability.

For other options, or for more information on any aspect of this device, please contact the ST Sales Office nearest you.

Table 9. Factory-Trimmed Thresholds with Marking Description

Suffix	Threshold Voltage V_{TH-} (V) at $T_A = 25^\circ\text{C}$ ⁽¹⁾			Topside Marking
	Min (-2%)	Typ	Max (+2%)	
16	1.568	1.600	1.632	16Nx
17	1.666	1.700	1.734	17Nx
19	1.862	1.900	1.938	19Nx
21	2.058	2.100	2.142	21Nx
22	2.156	2.200	2.244	22Nx
23	2.254	2.300	2.346	23Nx
25	2.450	2.500	2.550	25Nx
26	2.548	2.600	2.652	26Nx
27	2.646	2.700	2.754	27Nx
28	2.744	2.800	2.856	28Nx
29	2.842	2.900	2.958	29Nx
30	2.940	3.000	3.060	30Nx
31	3.038	3.100	3.162	31Nx
34	3.332	3.400	3.468	34Nx
38	3.724	3.800	3.876	38Nx

1. Other V_{TH-} thresholds are offered. Minimum order quantities may apply. Contact local sales office for availability.

9 Revision History

Table 10. Document Revision History

Date	Version	Description
20-January-2004	1.0	First Edition
01-Aug-05	1.1	Update Operation section, characteristics; insert new graphics; add ECOPACK information (Figure 7, 8, 9, 10, 11, 12, 13, and 14 ; Table 5, 8, and 9)
02-Sep-05	1.2	Update characteristics, remove 'push-pull output' reference (Figure 8, 9, 10, 11, 12, and 16 ; Table 2, , 5, and 8)
19-Oct-05	2.0	Status upgrade; update characteristics; add Marking information (Figure 7, 8, 9, 10, 11, 12, 13, and 14 ; Table 8, and 9)
18-Nov-05	3.0	Update characteristics (Table 3, and 4)
27-Jul-2006	4	Update Chapter : Features , Figure 1, 5, 6, Table 8 and 9 .

Please Read Carefully:

Information in this document is provided solely in connection with ST products. STMicroelectronics NV and its subsidiaries ("ST") reserve the right to make changes, corrections, modifications or improvements, to this document, and the products and services described herein at any time, without notice.

All ST products are sold pursuant to ST's terms and conditions of sale.

Purchasers are solely responsible for the choice, selection and use of the ST products and services described herein, and ST assumes no liability whatsoever relating to the choice, selection or use of the ST products and services described herein.

No license, express or implied, by estoppel or otherwise, to any intellectual property rights is granted under this document. If any part of this document refers to any third party products or services it shall not be deemed a license grant by ST for the use of such third party products or services, or any intellectual property contained therein or considered as a warranty covering the use in any manner whatsoever of such third party products or services or any intellectual property contained therein.

UNLESS OTHERWISE SET FORTH IN ST'S TERMS AND CONDITIONS OF SALE ST DISCLAIMS ANY EXPRESS OR IMPLIED WARRANTY WITH RESPECT TO THE USE AND/OR SALE OF ST PRODUCTS INCLUDING WITHOUT LIMITATION IMPLIED WARRANTIES OF MERCHANTABILITY, FITNESS FOR A PARTICULAR PURPOSE (AND THEIR EQUIVALENTS UNDER THE LAWS OF ANY JURISDICTION), OR INFRINGEMENT OF ANY PATENT, COPYRIGHT OR OTHER INTELLECTUAL PROPERTY RIGHT.

UNLESS EXPRESSLY APPROVED IN WRITING BY AN AUTHORIZED ST REPRESENTATIVE, ST PRODUCTS ARE NOT RECOMMENDED, AUTHORIZED OR WARRANTED FOR USE IN MILITARY, AIR CRAFT, SPACE, LIFE SAVING, OR LIFE SUSTAINING APPLICATIONS, NOR IN PRODUCTS OR SYSTEMS WHERE FAILURE OR MALFUNCTION MAY RESULT IN PERSONAL INJURY, DEATH, OR SEVERE PROPERTY OR ENVIRONMENTAL DAMAGE. ST PRODUCTS WHICH ARE NOT SPECIFIED AS "AUTOMOTIVE GRADE" MAY ONLY BE USED IN AUTOMOTIVE APPLICATIONS AT USER'S OWN RISK.

Resale of ST products with provisions different from the statements and/or technical features set forth in this document shall immediately void any warranty granted by ST for the ST product or service described herein and shall not create or extend in any manner whatsoever, any liability of ST.

ST and the ST logo are trademarks or registered trademarks of ST in various countries.

Information in this document supersedes and replaces all information previously supplied.

The ST logo is a registered trademark of STMicroelectronics. All other names are the property of their respective owners.

© 2006 STMicroelectronics - All rights reserved

STMicroelectronics group of companies

Australia - Belgium - Brazil - Canada - China - Czech Republic - Finland - France - Germany - Hong Kong - India - Israel - Italy - Japan - Malaysia - Malta - Morocco - Singapore - Spain - Sweden - Switzerland - United Kingdom - United States of America

www.st.com



Looking for pricing, stock, or lifecycle information?

Click below to explore more details on WIN SOURCE:

- ⊖ [View STM1061N29WX6F on WIN SOURCE](#)
- ⊖ [STMicroelectronics Information](#)

Optimize Your Supply Chain with WIN SOURCE Solutions

- ✓ Global Sourcing Solution
- ✓ Obsolete Management
- ✓ Cost Control Management
- ✓ Shortage Management
- ✓ Alternative Solution
- ✓ Excess Inventory Management