



**THE DATASHEET OF
STGD7NB60ST4**





STGD7NB60S

N-CHANNEL 7A - 600V DPAK Power MESH™ IGBT

TYPE	V _{CES}	V _{CE(sat)}	I _C
STGD7NB60S	600 V	< 1.6 V	7 A

- HIGH INPUT IMPEDANCE (VOLTAGE DRIVEN)
- VERY LOW ON-VOLTAGE DROP (V_{cesat})
- HIGH CURRENT CAPABILITY
- OFF LOSSES INCLUDE TAIL CURRENT
- SURFACE-MOUNTING DPAK (TO-252) POWER PACKAGE IN TAPE & REEL (SUFFIX "T4")

DESCRIPTION

Using the latest high voltage technology based on a patented strip layout, STMicroelectronics has designed an advanced family of IGBTs, the PowerMESH™ IGBTs, with outstanding performances. The suffix "S" identifies a family optimized to achieve minimum on-voltage drop for low frequency applications (<1kHz).

APPLICATIONS

- LIGHT DIMMER
- STATIC RELAYS
- MOTOR CONTROL

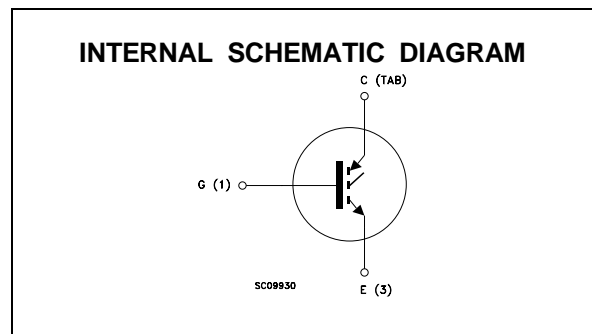
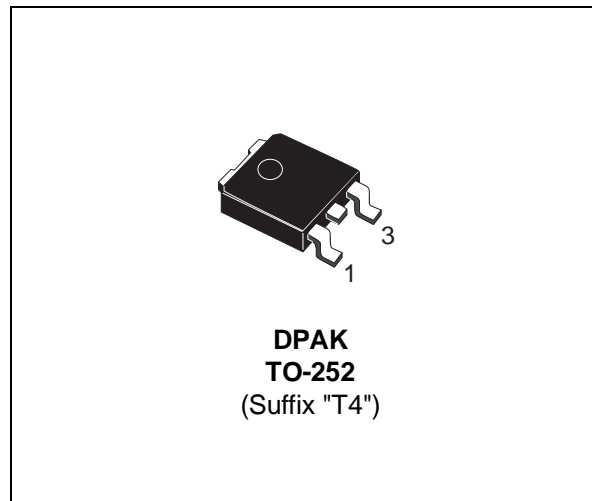

ABSOLUTE MAXIMUM RATINGS

Symbol	Parameter	Value	Unit
V _{CES}	Collector-Emitter Voltage (V _{GS} = 0)	600	V
V _{ECR}	Reverse Battery Protection	20	V
V _{GE}	Gate-Emitter Voltage	± 20	V
I _C	Collector Current (continuous) at T _c = 25 °C	15	A
I _C	Collector Current (continuous) at T _c = 100 °C	7	A
I _{CM} (•)	Collector Current (pulsed)	60	A
P _{tot}	Total Dissipation at T _c = 25 °C	55	W
	Derating Factor	0.44	W/°C
T _{stg}	Storage Temperature	-65 to 150	°C
T _j	Max. Operating Junction Temperature	150	°C

(•) Pulse width limited by safe operating area

STGD7NB60S

THERMAL DATA

R _{thj-case}	Thermal Resistance Junction-case	Max	2.27	°C/W
R _{thj-amb}	Thermal Resistance Junction-ambient	Max	100	°C/W
R _{thc-sink}	Thermal Resistance Case-sink	Typ	1.5	°C/W

ELECTRICAL CHARACTERISTICS (T_j = 25 °C unless otherwise specified)

OFF

Symbol	Parameter	Test Conditions	Min.	Typ.	Max.	Unit
V _{BR(CES)}	Collector-Emitter Breakdown Voltage	I _C = 250 μA V _{GE} = 0	600			V
V _{BR(ECR)}	Emitter-Collector Breakdown Voltage	I _C = 1 mA V _{GE} = 0	20			V
I _{CES}	Collector cut-off (V _{GE} = 0)	V _{CE} = Max Rating T _j = 25 °C V _{CE} = Max Rating T _j = 125 °C			10 100	μA μA
I _{GES}	Gate-Emitter Leakage Current (V _{CE} = 0)	V _{GE} = ± 20 V V _{CE} = 0			± 100	nA

ON (*)

Symbol	Parameter	Test Conditions	Min.	Typ.	Max.	Unit
V _{GE(th)}	Gate Threshold Voltage	V _{CE} = V _{GE} I _C = 250 μA	2.5		5	V
V _{CE(SAT)}	Collector-Emitter Saturation Voltage	V _{GE} = 15 V I _C = 3 A V _{GE} = 15 V I _C = 7 A V _{GE} = 15 V I _C = 7 A T _j = 125 °C		1 1.2 1.1	1.4 1.6	V V V

DYNAMIC

Symbol	Parameter	Test Conditions	Min.	Typ.	Max.	Unit
g _{fs}	Forward Transconductance	V _{CE} = 25 V I _C = 7 A	4			S
C _{ies} C _{oes} C _{res}	Input Capacitance Output Capacitance Reverse Transfer Capacitance	V _{CE} = 25 V f = 1 MHz V _{GE} = 0		610 65 12	780 85 15	pF pF pF
Q _G	Gate Charge	V _{CE} = 400 V I _C = 7 A V _{GE} = 15 V		33		nC
I _{CL}	Latching Current	V _{clamp} = 480 V R _G = 1kΩ T _j = 150 °C	15			A

SWITCHING ON

Symbol	Parameter	Test Conditions	Min.	Typ.	Max.	Unit
t _{d(on)} t _r	Delay Time Rise Time	V _{CC} = 480 V I _C = 7 A V _{GE} = 15 V R _G = 1 KΩ		0.7 0.46		μs μs
(di/dt) _{on}	Turn-on Current Slope	V _{CC} = 480 V I _C = 7 A R _G = 1 KΩ V _{GE} = 15 V		8		A/μs
E _{on}	Turn-on Switching Losses	T _j = 125 °C		0.4		mJ

ELECTRICAL CHARACTERISTICS (continued)

SWITCHING OFF

Symbol	Parameter	Test Conditions	Min.	Typ.	Max.	Unit
t_c	Cross-Over Time	$V_{CC} = 480\text{ V}$		2.2		μs
$t_r(V_{off})$	Off Voltage Rise Time	$R_{GE} = 100\ \Omega$		1.2		μs
t_f	Fall Time	$I_C = 7\text{ A}$ $V_{GE} = 15\text{ V}$		1.2		μs
$E_{off(**)}$	Turn-off Switching Loss			3.5		mJ
t_c	Cross-Over Time	$V_{CC} = 480\text{ V}$		3.8		μs
$t_r(V_{off})$	Off Voltage Rise Time	$R_{GE} = 100\ \Omega$		1.2		μs
t_f	Fall Time	$I_C = 7\text{ A}$ $V_{GE} = 15\text{ V}$ $T_j = 125\text{ }^\circ\text{C}$		1.9		μs
$E_{off(**)}$	Turn-off Switching Loss			5.3		mJ

- (●) Pulse width limited by safe operating area
- (*) Pulsed: Pulse duration = 300 μs , duty cycle 1.5 %
- (**) Losses Include Also The Tail (Jedec Standardization)

Thermal Impedance

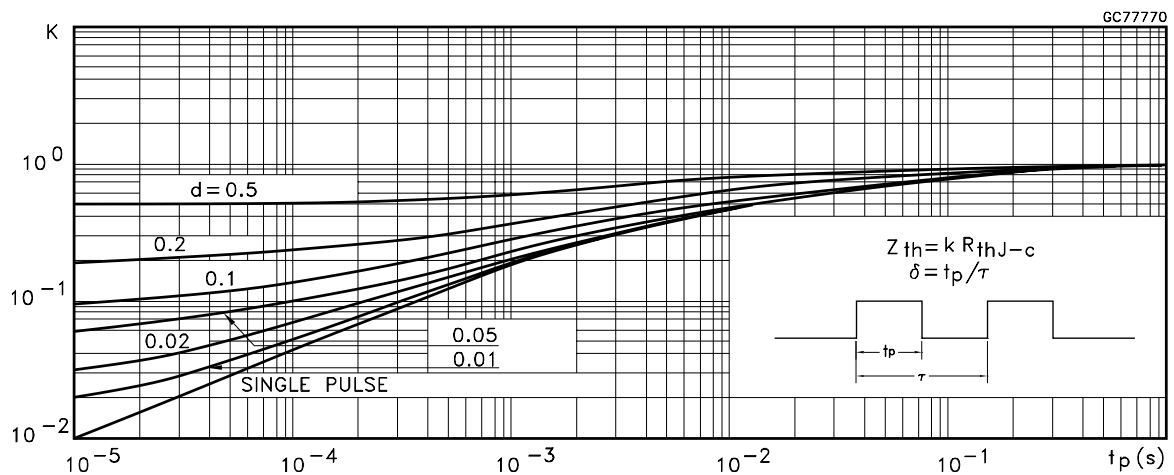

Output Characteristics

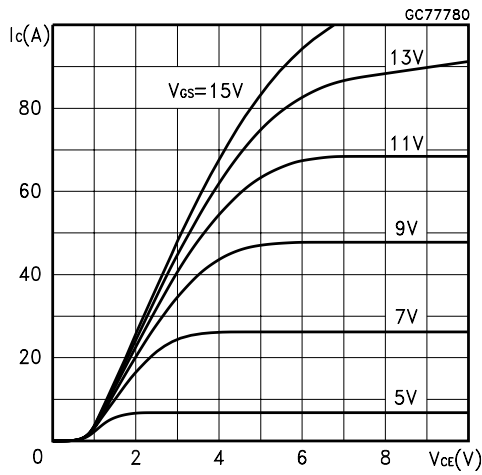

Transfer Characteristics

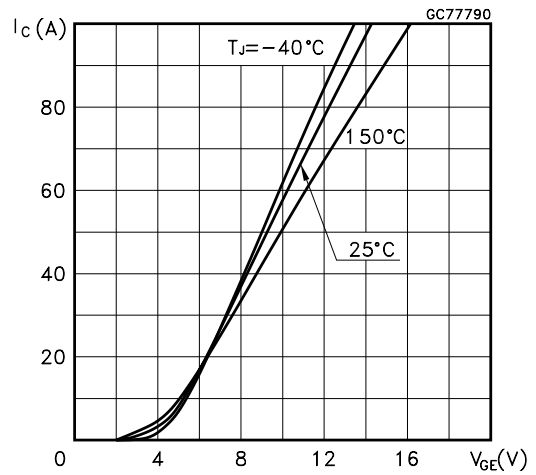

Transconductance

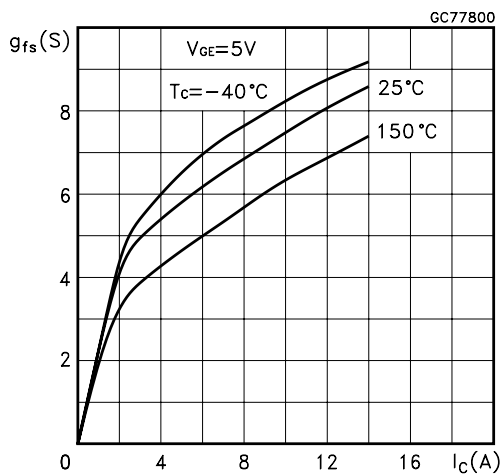

Collector-Emitter On Voltage vs Temperature

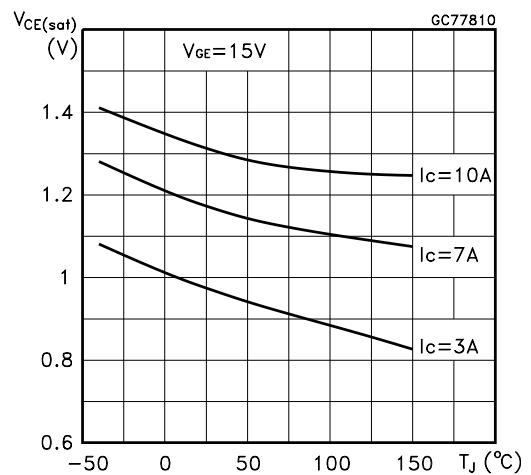

Collector-Emitter On Voltage vs Collector Current

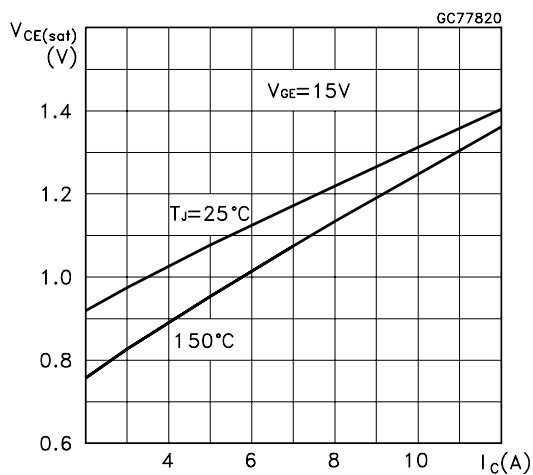

Gate Threshold vs Temperature

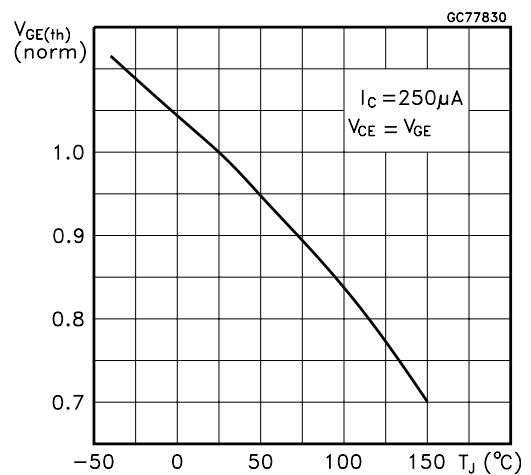

Normalized Breakdown Voltage vs Temperature

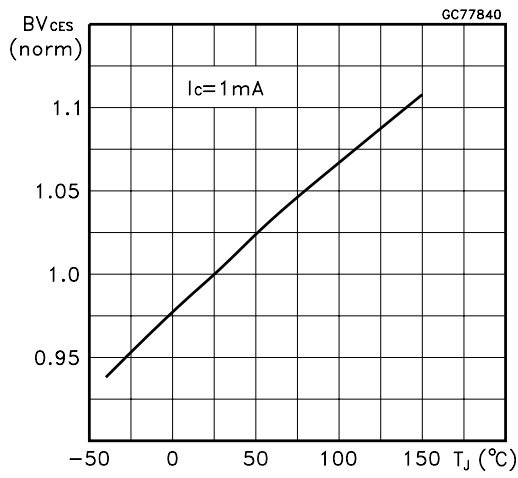

Capacitance Variations

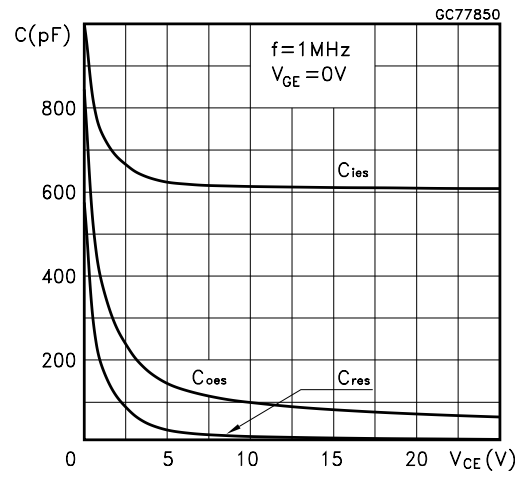

Gate Charge vs Gate-Emitter Voltage

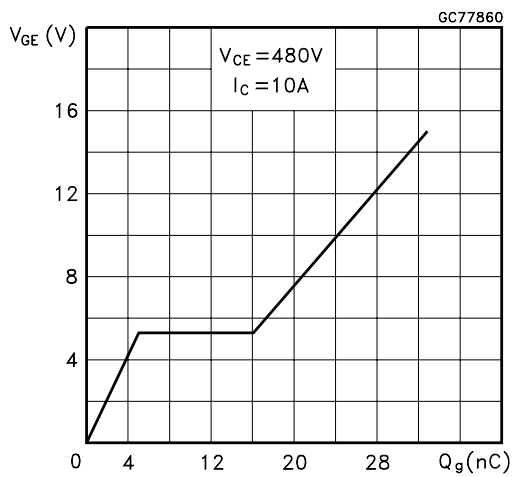

Off Losses vs Gate Resistance

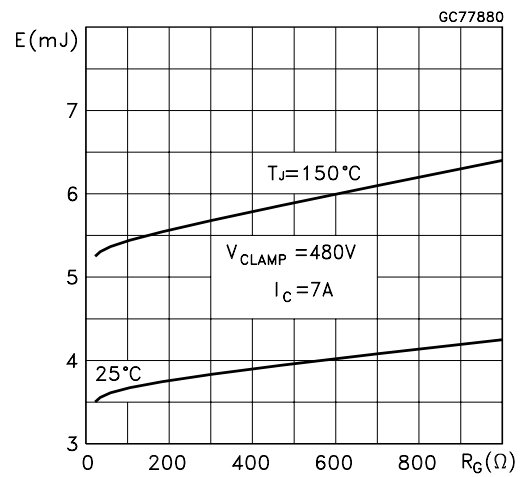

Off Losses vs Temperature

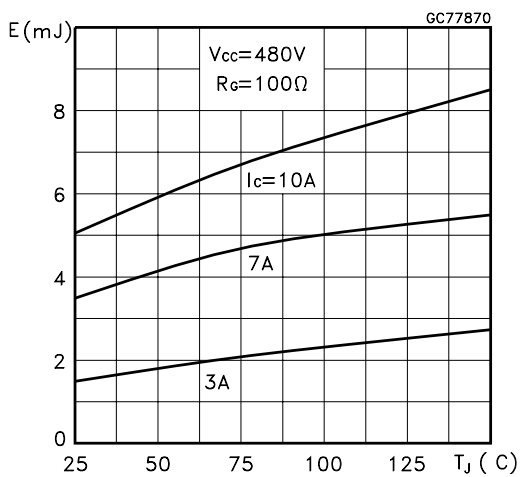

Off Losses vs Collector Current

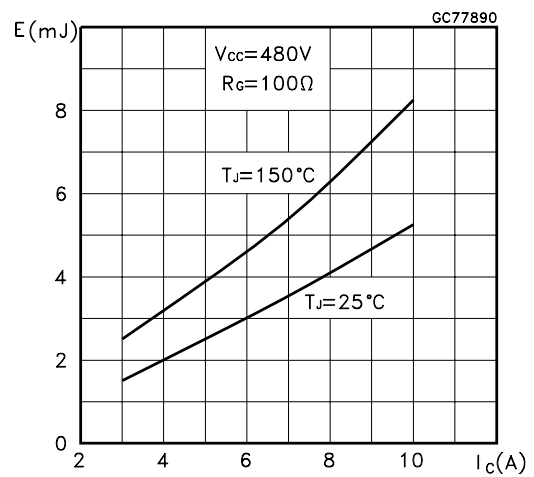

Switching Off Safe Operatin Area

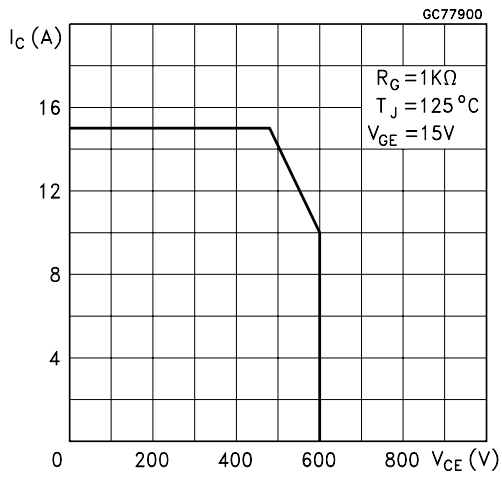

Fig. 1: Gate Charge test Circuit

Fig. 2: Test Circuit For Inductive Load Switching

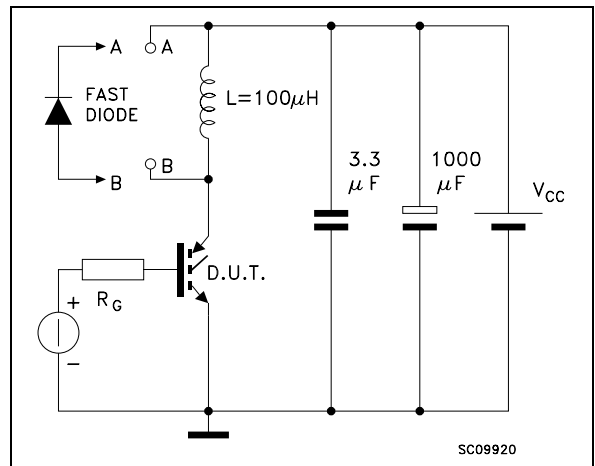
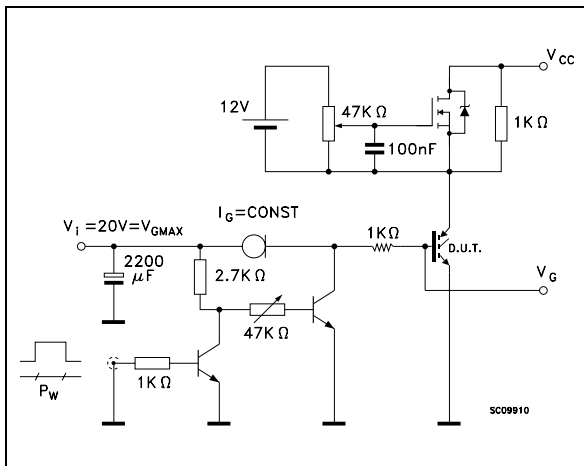
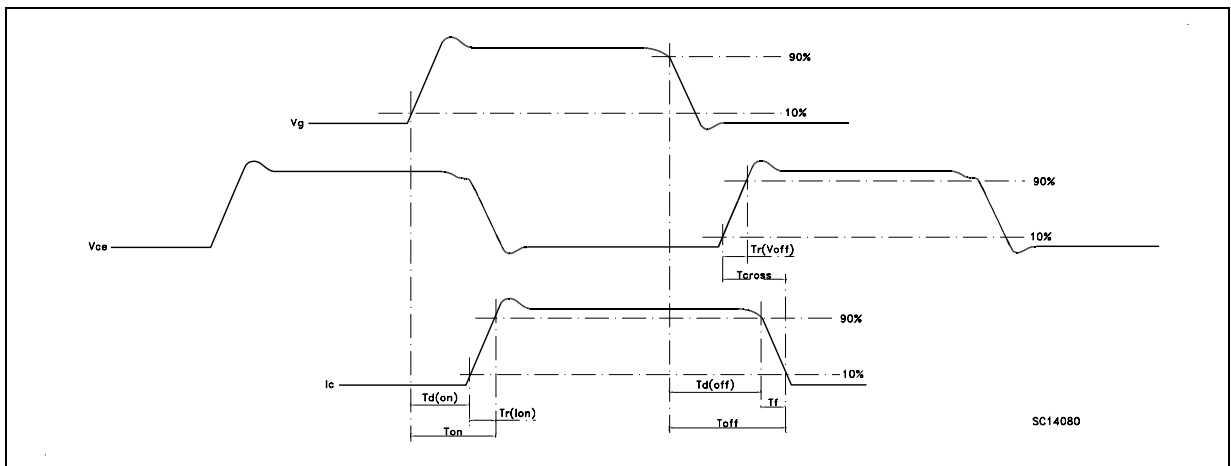
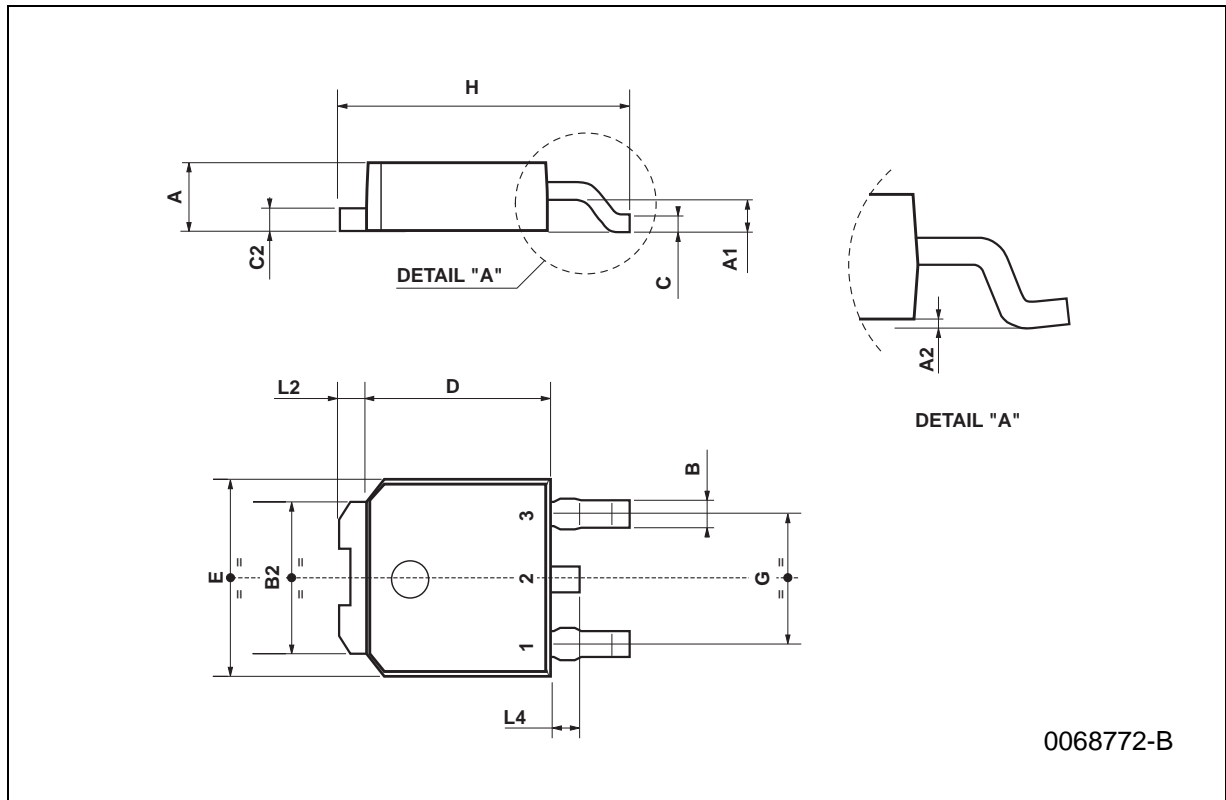

Fig. 3: Switching Waveforms



TO-252 (DPAK) MECHANICAL DATA

DIM.	mm			inch		
	MIN.	TYP.	MAX.	MIN.	TYP.	MAX.
A	2.2		2.4	0.086		0.094
A1	0.9		1.1	0.035		0.043
A2	0.03		0.23	0.001		0.009
B	0.64		0.9	0.025		0.035
B2	5.2		5.4	0.204		0.212
C	0.45		0.6	0.017		0.023
C2	0.48		0.6	0.019		0.023
D	6		6.2	0.236		0.244
E	6.4		6.6	0.252		0.260
G	4.4		4.6	0.173		0.181
H	9.35		10.1	0.368		0.397
L2		0.8			0.031	
L4	0.6		1	0.023		0.039



Information furnished is believed to be accurate and reliable. However, STMicroelectronics assumes no responsibility for the consequences of use of such information nor for any infringement of patents or other rights of third parties which may result from its use. No license is granted by implication or otherwise under any patent or patent rights of STMicroelectronics. Specification mentioned in this publication are subject to change without notice. This publication supersedes and replaces all information previously supplied. STMicroelectronics products are not authorized for use as critical components in life support devices or systems without express written approval of STMicroelectronics.

The ST logo is a trademark of STMicroelectronics



© 1999 STMicroelectronics – Printed in Italy – All Rights Reserved
STMicroelectronics GROUP OF COMPANIES

Australia - Brazil - China - Finland - France - Germany - Hong Kong - India - Italy - Japan - Malaysia - Malta - Morocco -
Singapore - Spain - Sweden - Switzerland - United Kingdom - U.S.A.

<http://www.st.com>

Looking for pricing, stock, or lifecycle information?

Click below to explore more details on WIN SOURCE:

-  [View STGD7NB60ST4 on WIN SOURCE](#)
-  [STMicroelectronics](#) Information

Optimize Your Supply Chain with WIN SOURCE Solutions

-  Global Sourcing Solution
-  Obsolete Management
-  Cost Control Management
-  Shortage Management
-  Alternative Solution
-  Excess Inventory Management