



**THE DATASHEET OF
SRDB-10E33HR**



NON-ISOLATED DC/DC CONVERTERS

4.5V – 13.2V Input / 1.0V – 5.0V Output / 10A



BP05SRDB-10E

SRDB-10E Series

- Nonisolated
- Compact, low profile surface mount package
- Wide input
- High efficiency means less power dissipation
- Excellent thermal performance
- Optimized for cost
- Remote on/off
- Undervoltage lockout (UVLO)
- Over current and short circuit protection
- Remote sense
- Active high/low

Description

The Bel SRDB-10E modules are a series of non-isolated, step down DC/DC power converters that operate from a nominal 4.5V to 13.2V source. These converters are available in a range of output voltages from 1.0V to 5.0V. The output is closely regulated and the efficiency of the 3.3V output module is typically 88% at full load. The modules are packaged in a compact, low profile, surface mount DIP package for ease of layout and space savings. 10A maximum output is also provided. Standard features include remote on/off, remote sense, over current and short circuit protection, UVLO and output voltage adjust. These products may be used almost anywhere low voltage silicon is employed and a 4.5V to 13.2V source is available. Typical applications include file servers, routers, line cards and other computing and communications equipment.

Applications

- Distributed power architectures
- Data networking equipment
- Telecommunications
- Computers and peripherals

Part Number Selection

Output Voltage	Input Voltage	Max. Output Current	Max. Output Power	Typical Efficiency	Part Number Active Low	Part Number Active High
5.0V	8V - 13.2V	10A	50W	91%	SRDB-10E500	SRDB-10E50H
3.3V	4.5V - 13.2V	10A	33W	88%	SRDB-10E330	SRDB-10E33H
2.5V	4.5V - 13.2V	10A	25W	86%	SRDB-10E250	SRDB-10E25H
1.8V	4.5V - 13.2V	10A	18W	82%	SRDB-10E180	SRDB-10E18H
1.5V	4.5V - 13.2V	10A	15W	80%	SRDB-10E150	SRDB-10E15H
1.2V	4.5V - 13.2V	10A	12W	77%	SRDB-10E120	SRDB-10E12H
1.0V	4.5V - 13.2V	10A	10W	75%	SRDB-10E100	SRDB-10E10H

©2005 Bel Fuse Inc. Specifications subject to change without notice. 03.05

BP05SRDB-10E

Absolute Maximum Ratings

Parameter	Symbol	Min	Typical	Max	Unit
Continuous Input Voltage	V _{in}	-0.3		16	V
Output Enable Terminal Voltage	V _{outen}	-0.5		7	V
Ambient Temperature	T _{amb}	0		70	°C
Storage Temperature	T _{stor}	-40		105	°C

Note: Use beyond the maximum ratings may cause a reliability degradation of the DC/DC converter or may permanently damage the device.

Input Specifications

Parameter	Module	Symbol	Min	Typical	Max	Units
Operating Input Voltage	1.0V - 3.3V 5.0V	V _{in}	4.5 8		13.2 13.2	V
Input Current	5.0V 3.3V 2.5V 1.8V 1.5V 1.2V 1.0V	I _{in}			7.9 9.1 7.4 5.6 4.8 4 3.4	A
No Load Input Current	V _{in} = 4.5V	I _{in}		60		mA
No Load Input Current	V _{in} = 8.0V	I _{in}		80		mA
No Load Input Current	V _{in} = 13.2V	I _{in}		100		mA
Input Reflected Ripple Current ¹	All			40	80	mA _{rms}
Input Reflected Ripple Current (P-P) ¹	All			120	200	mApk
I ² t Inrush Current Transient	All			0.1	0.2	A ² s
Turn On Voltage Threshold	All			4	4.5	V
Turn Off Voltage Threshold	All			3.5	4.2	V

Note: Input capacitance two 270µF/16V, ESR = 0.018 Ω max at 100kHz @ 25° C.
1. With simulated source impedance of 500nH, 5Hz to 20MHz.

NON-ISOLATED DC/DC CONVERTERS

4.5V – 13.2V Input / 1.0V – 5.0V Output / 10A



BP05SRDB-10E

Output Specifications

Parameter	Module	Symbol	Min	Typical	Max	Units
Output Voltage Set Point ¹	5.0V	Vout	4.900	5.0	5.100	V
	3.3V		3.234	3.3	3.366	
	2.5V		2.450	2.5	2.550	
	1.8V		1.764	1.8	1.836	
	1.5V		1.470	1.5	1.530	
	1.2V		1.176	1.2	1.224	
	1.0V		0.980	1.0	1.020	
Load Regulation	5.0V			10	20	mV
	3.3V		7	14		
	2.5V		6	12		
	1.8V		6	12		
	1.5V		6	12		
	1.2V		5	10		
	1.0V		5	10		
Line Regulation	5.0V			3	6	mV
	3.3V		3	6		
	2.5V		2	5		
	1.8V		2	5		
	1.5V		2	5		
	1.2V		2	5		
	1.0V		2	5		
Regulation Over Temperature	5.0V			30	60	mV
	3.3V		24	48		
	2.5V		22	44		
	1.8V		20	40		
	1.5V		18	36		
	1.2V		16	32		
	1.0V		14	28		
Total Output Voltage Regulation	5.0V			43	86	mV
	3.3V		34	68		
	2.5V		30	61		
	1.8V		28	57		
	1.5V		26	53		
	1.2V		23	47		
	1.0V		21	43		
Output Ripple and Noise ²	All			50	100	mVp-p
Output Ripple and Noise ²	All			15	30	mVrms
Output Current Range	All	Iout	0		10	A
Output DC Current Limit	All	Ioutlim	12		25	A
Short Circuit Surge	All	Ioutsurge		0.1	0.2	A ² s
Turn on Time	All	Ton			20	ms
Overshoot at Turn On	All			0	3%	V
Output Capacitance	All	Cout	0		4000	μF

Note: All specifications are typical at nominal input, full load at 25° C unless otherwise stated.

1. Vin = 8V, Iout = full load, Ta = 25° C.

2. Two 270μF/16V with ESR = 0.018 Ω max at input, 0 - 20MHz BW, 1μF ceramic cap and 10μF aluminum cap at output.

©2005 Bel Fuse Inc. Specifications subject to change without notice. 03.05

BP05SRDB-10E

Output Specifications

Parameter	Module	Symbol	Min	Typical	Max	Units
Transient Response ³						
ΔV 50% to 100% of Max Load	8V to 13.2V Input 5V Output			120	200	mV
Settling Time		Ts		60	100	μs
ΔV 100% to 50% of Max Load				120	200	mV
Settling Time		Ts		60	100	μs
Transient Response ³						
ΔV 50% to 100% of Max Load	4.5V to 13.2V Input 3.3V Output			90	150	mV
Settling Time		Ts		60	100	μs
ΔV 100% to 50% of Max Load				90	150	mV
Settling Time		Ts		60	100	μs
Transient Response ³						
ΔV 50% to 100% of Max Load	4.5V to 13.2V Input 2.5V Output			80	150	mV
Settling Time		Ts		60	100	μs
ΔV 100% to 50% of Max Load				80	150	mV
Settling Time		Ts		60	100	μs
Transient Response ³						
ΔV 50% to 100% of Max Load	4.5V to 13.2V Input 1.8V Output			80	150	mV
Settling Time		Ts		60	100	μs
ΔV 100% to 50% of Max Load				80	150	mV
Settling Time		Ts		60	100	μs
Transient Response ³						
ΔV 50% to 100% of Max Load	4.5V to 13.2V Input 1.5V Output			80	150	mV
Settling Time		Ts		60	100	μs
ΔV 100% to 50% of Max Load				80	150	mV
Settling Time		Ts		60	100	μs
Transient Response ³						
ΔV 50% to 100% of Max Load	4.5V to 13.2V Input 1.2V Output			80	150	mV
Settling Time		Ts		60	100	μs
ΔV 100% to 50% of Max Load				80	150	mV
Settling Time		Ts		60	100	μs
Transient Response ³						
ΔV 50% to 100% of Max Load	4.5V to 13.2V Input 1.0V Output			80	150	mV
Settling Time		Ts		60	100	μs
ΔV 100% to 50% of Max Load				80	150	mV
Settling Time		Ts		60	100	μs

Note: All specifications are typical at nominal input, full load at 25° C unless otherwise stated.
 3. di/dt = 0.5A/ μs , Ta = 25° C with external 220 μF Tan cap.

NON-ISOLATED DC/DC CONVERTERS

4.5V – 13.2V Input / 1.0V – 5.0V Output / 10A



BP05SRDB-10E

General Specifications

Parameter	Module	Symbol	Min	Typical	Max	Units
Efficiency ¹ Vin = 12V, Io = Io max	5.0V	η	88	91		%
	3.3V		85	88		
	2.5V		83	86		
	1.8V		79	82		
	1.5V		77	80		
	1.2V		74	77		
	1.0V		72	75		
Switching Frequency	All	Fsw	250	310	370	kHz
Output Voltage Trim Range ²	All		90		110	%
Remote Sense Compensation	All				10	%
Weight	All			10.5		g

1. Vin=12V, full load and Ta=25° C.

2. See graphs on pages 13 - 16.

Note: For 3.3V output module, when the input voltage is between 4.5Vdc to 5.0Vdc, the output voltage trim range is 90%-105%, and the remote sense compensation is 5%.

Control Specifications

Parameter	Module	Symbol	Min	Typical	Max	Units
Remote On/Off ³	All	Vouten				V
Signal Low (Unit Off)	S7DB-10ExxH		0		0.9	V
Signal High (Unit On)			2.1		5	V
Signal Low (Unit On)	S7DB-10Exx0		0		0.9	V
Signal High (Unit Off)			2.1		5	V

3. With remote on/off pin 8 open, the module is on.

BP05SRDB-10E

Efficiency Data

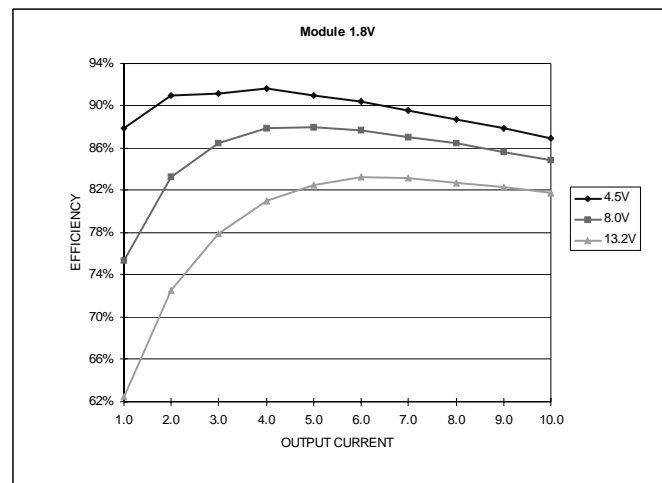
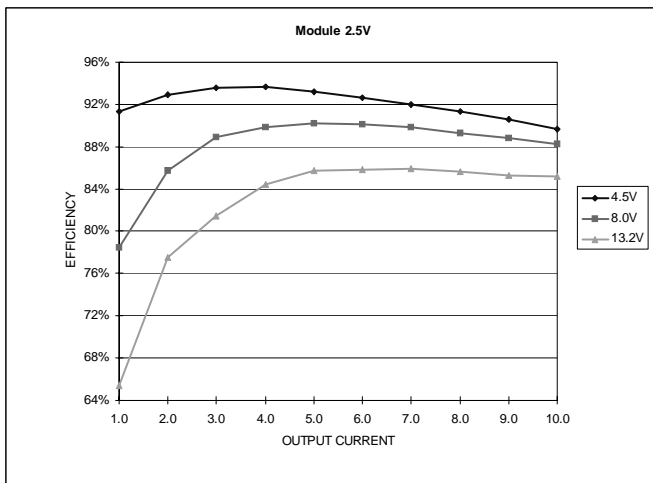
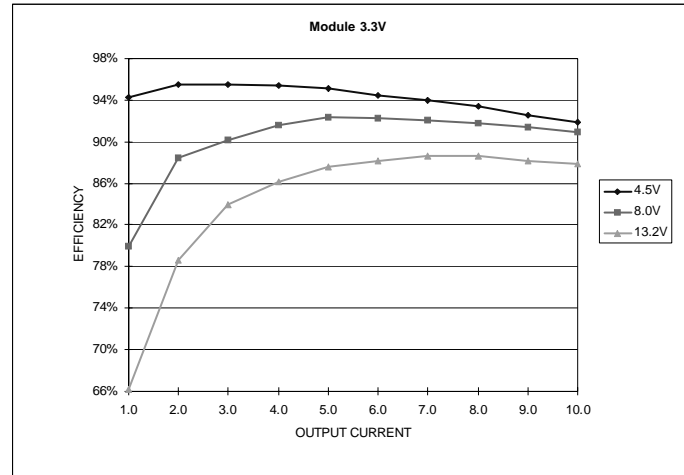
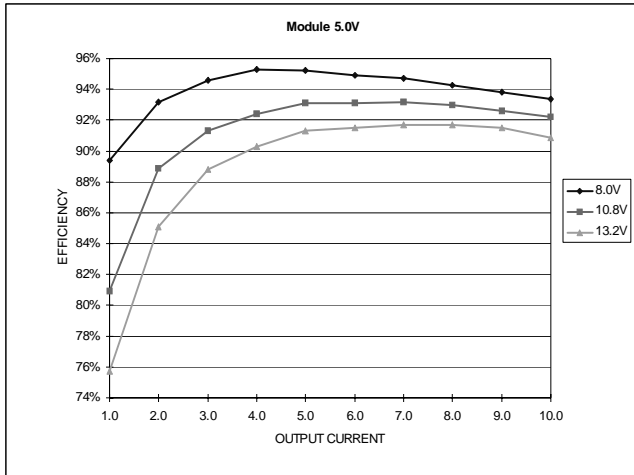

NON-ISOLATED DC/DC CONVERTERS

4.5V – 13.2V Input / 1.0V – 5.0V Output / 10A



BP05SRDB-10E

Efficiency Data

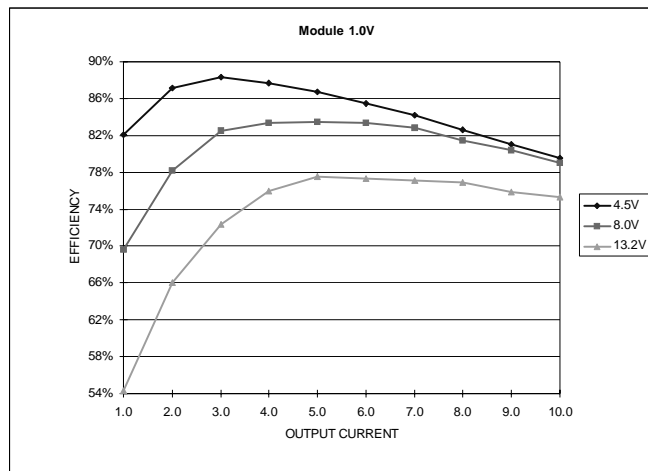
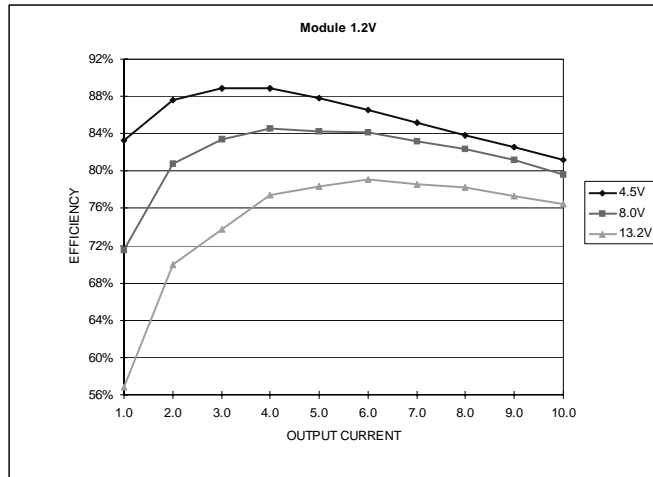
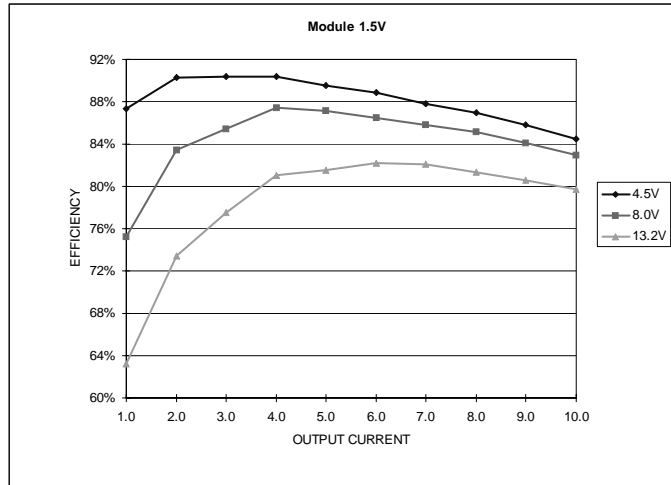

BP05SRDB-10E

Ripple and Noise

1 μ F ceramic cap and 10 μ F aluminum electrolytic cap added at the output.

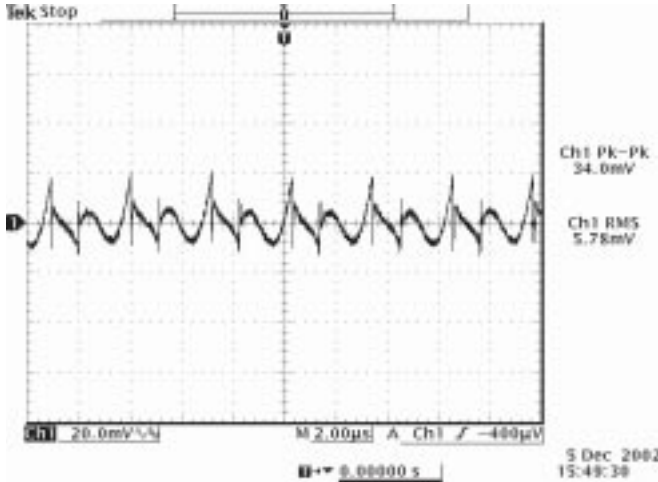

Ripple and noise at full load and 8Vdc input, 5.0Vdc output and Ta=25° C

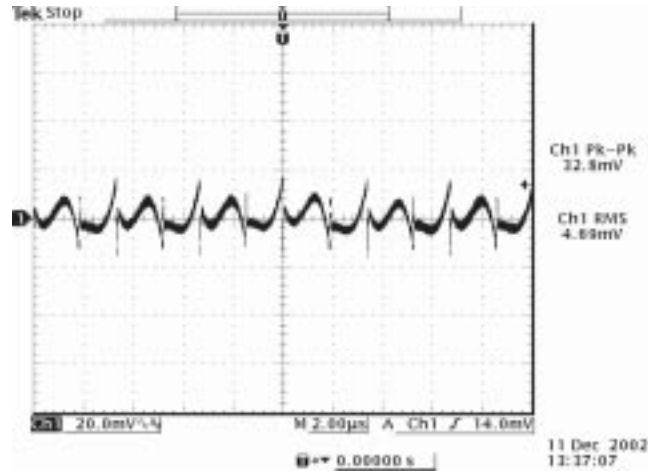

Ripple and noise at full load and 8Vdc input, 3.3Vdc output and Ta=25° C

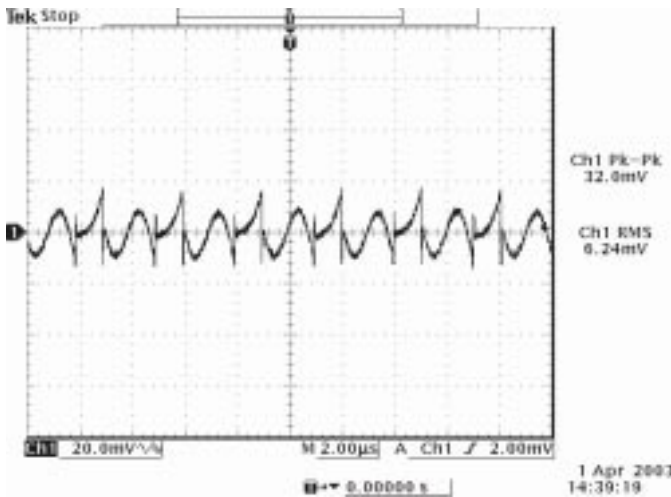

Ripple and noise at full load and 8Vdc input, 2.5Vdc output and Ta=25° C

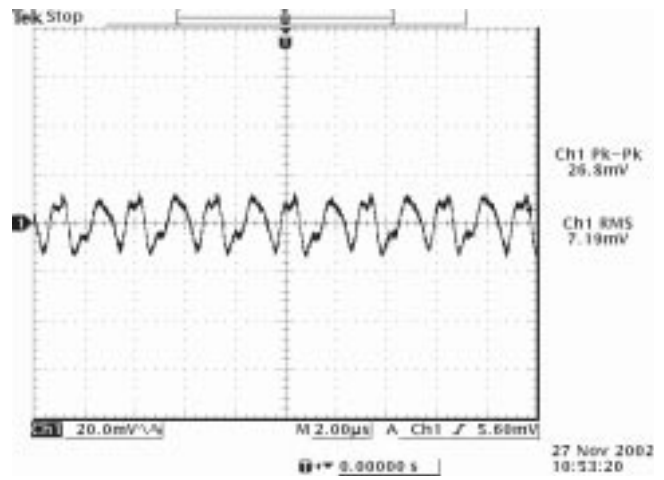

Ripple and noise at full load and 8Vdc input, 1.8Vdc output and Ta=25° C

NON-ISOLATED DC/DC CONVERTERS

4.5V – 13.2V Input / 1.0V – 5.0V Output / 10A



BP05SRDB-10E

Ripple and Noise

1 μ F ceramic cap and 10 μ F aluminum electrolytic cap added at the output.

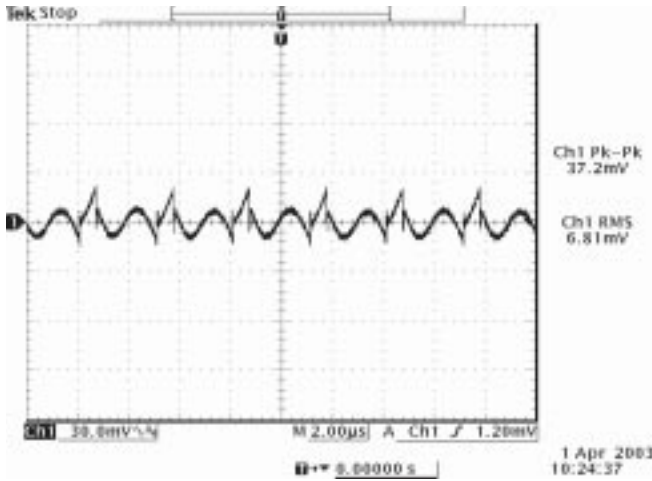

Ripple and noise at full load and 8Vdc input, 1.5Vdc output and Ta=25° C

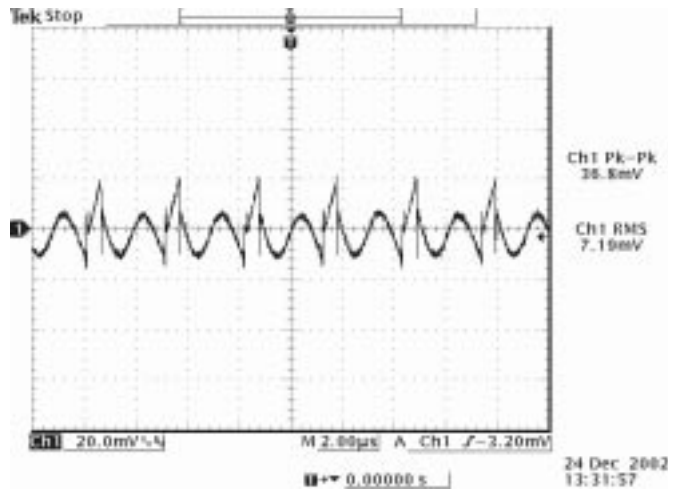

Ripple and noise at full load and 8Vdc input, 1.2Vdc output and Ta=25° C

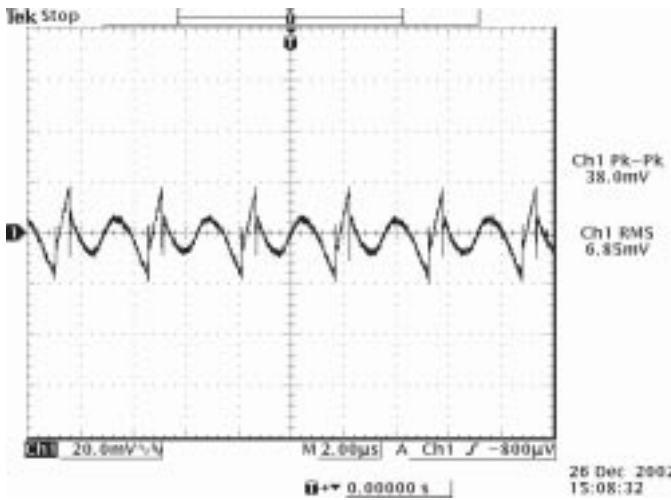

Ripple and noise at full load and 8Vdc input, 1.0Vdc output and Ta=25° C

BP05SRDB-10E

Transient Response

Transient response: $di/dt = 0.5A/\mu S$, with external 220 μF Tan capacitor.

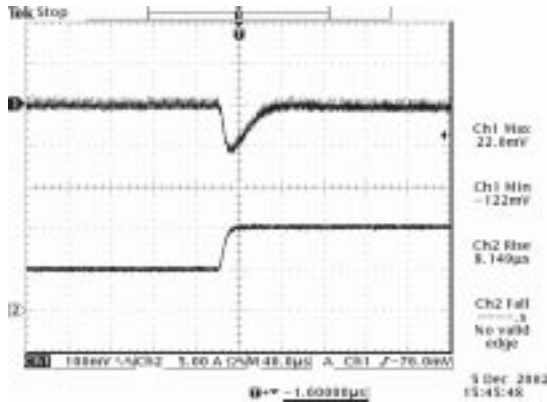

Vout=5.0V
50% to 100% load transients at 8V input and Ta=25° C

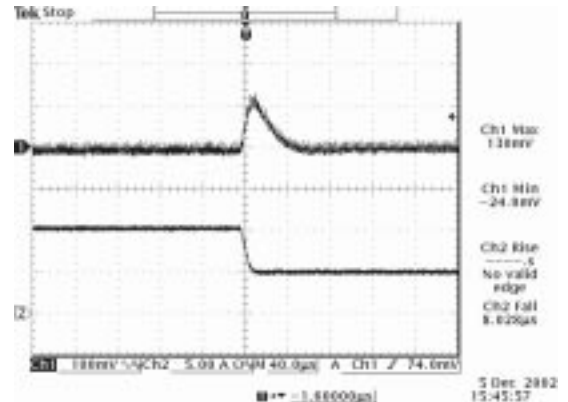

Vout=5.0V
100% to 50% load transients at 8V input and Ta=25° C

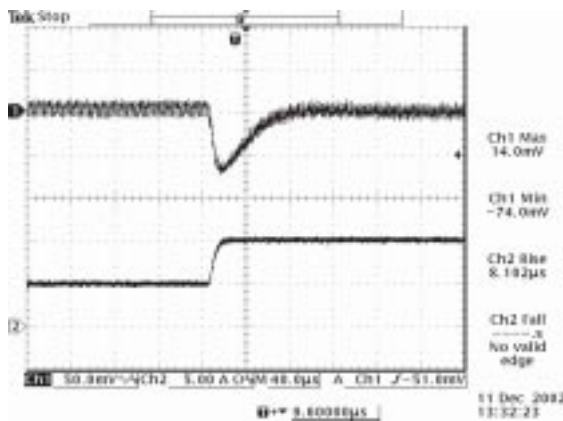

Vout=3.3V
50% to 100% load transients at 8V input and Ta=25° C

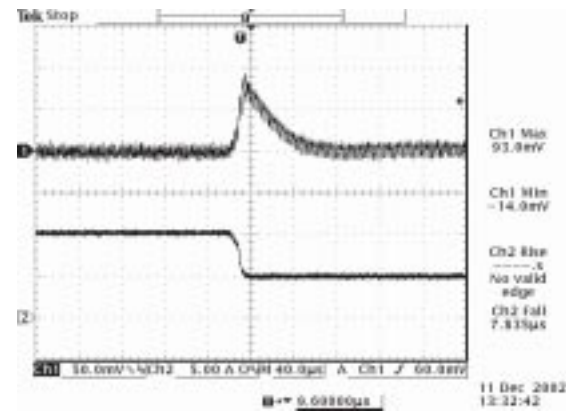

Vout=3.3V
100% to 50% load transients at 8V input and Ta=25° C

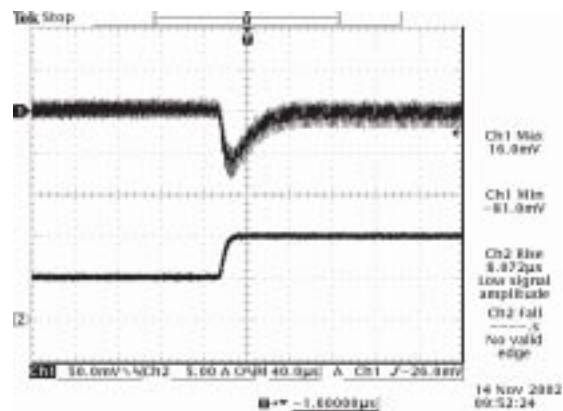

Vout=2.5V
50% to 100% load transients at 8V input and Ta=25° C

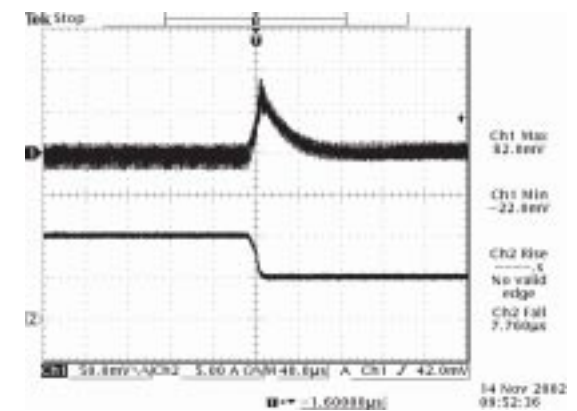

Vout=2.5V
100% to 50% load transients at 8V input and Ta=25° C

NON-ISOLATED DC/DC CONVERTERS

4.5V – 13.2V Input / 1.0V – 5.0V Output / 10A



BP05SRDB-10E

Transient Response

Transient response: $di/dt = 0.5A/\mu S$, with external $220\mu F$ Tan capacitor.

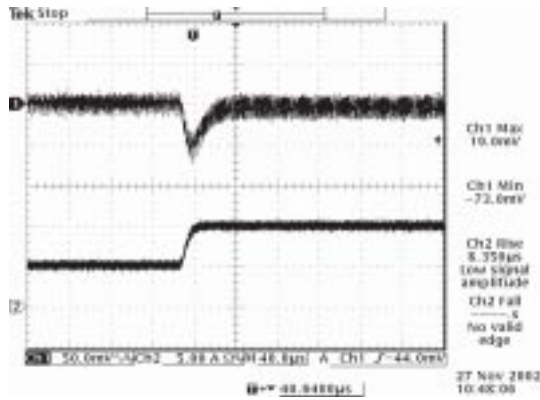

Vout=1.8V
50% to 100% load transients at 8V input and Ta=25° C

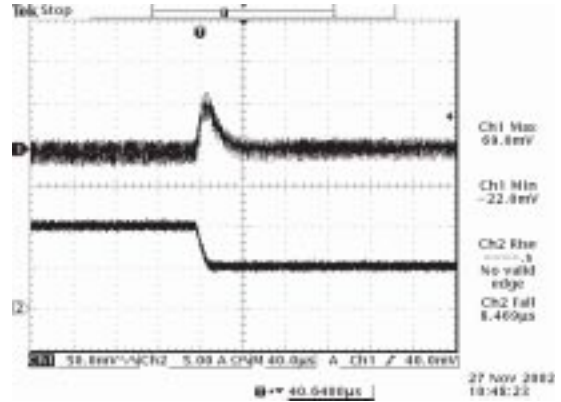

Vout=1.8V
100% to 50% load transients at 8V input and Ta=25° C

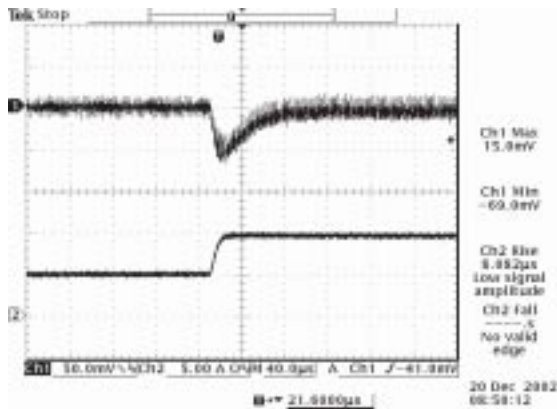

Vout=1.5V
50% to 100% load transients at 8V input and Ta=25° C

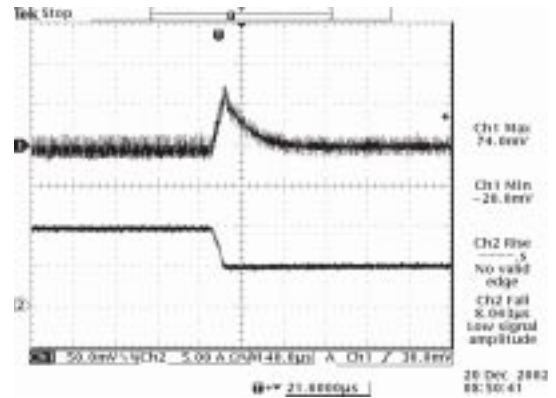

Vout=1.5V
100% to 50% load transients at 8V input and Ta=25° C

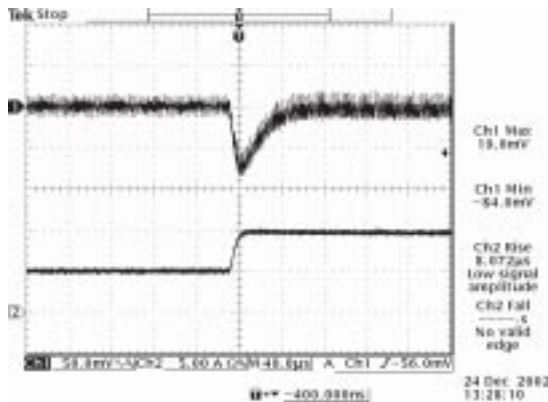

Vout=1.2V
50% to 100% load transients at 8V input and Ta=25° C

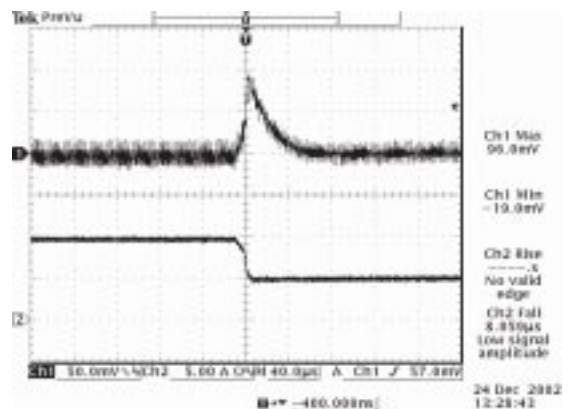

Vout=1.2V
100% to 50% load transients at 8V input and Ta=25° C

BP05SRDB-10E

Transient Response

Transient response: $di/dt = 0.5A/\mu S$, with external $220\mu F$ Tan capacitor.

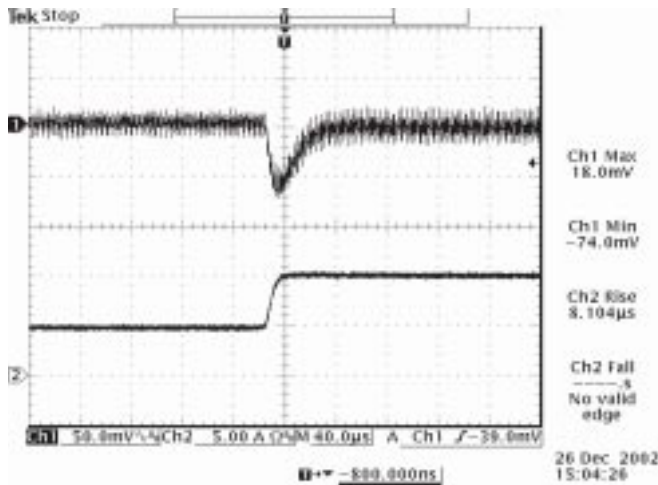

$V_{out}=1.0V$
50% to 100% load transients at 8V input and $T_a=25^\circ C$

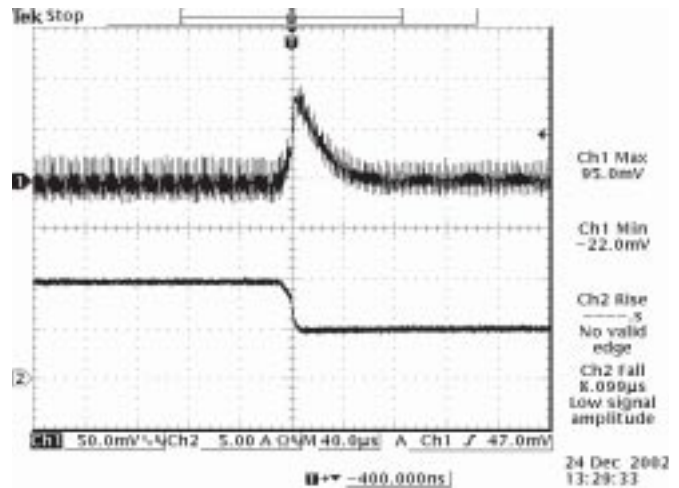

$V_{out}=1.0V$
100% to 50% load transients at 8V input and $T_a=25^\circ C$

Thermal Considerations

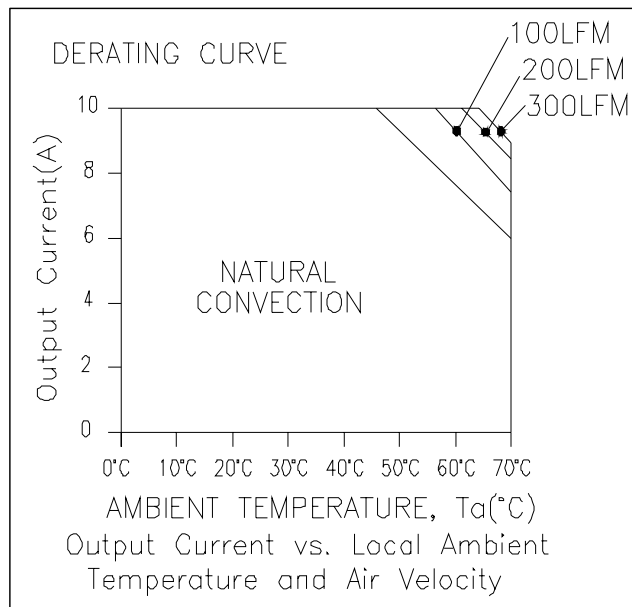

NON-ISOLATED DC/DC CONVERTERS

4.5V – 13.2V Input / 1.0V – 5.0V Output / 10A



BP05SRDB-10E

Output Voltage Set-Point Adjustment

Trim Down Test Circuit

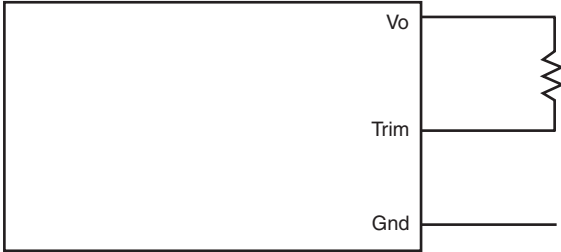

Trim Up Test Circuit

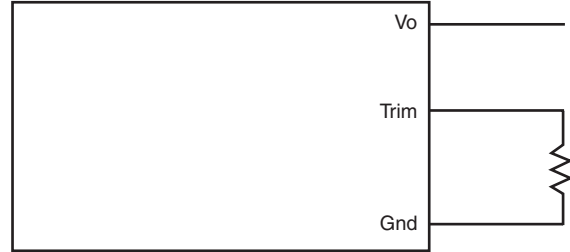

Output Voltage Set-Point Adjustment

SRDB-10E50x Trim Resistor Calculation

$$R_{trim_down} = \left(\frac{61.91}{V_o - V_{o,adj}} - 31.61 \right) \text{Kohm}$$

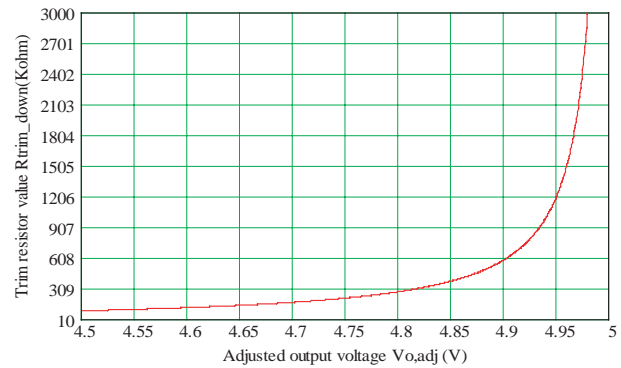

$$R_{trim_up} = \left(\frac{11.768}{V_{o,adj} - V_o} - 16.9 \right) \text{Kohm}$$

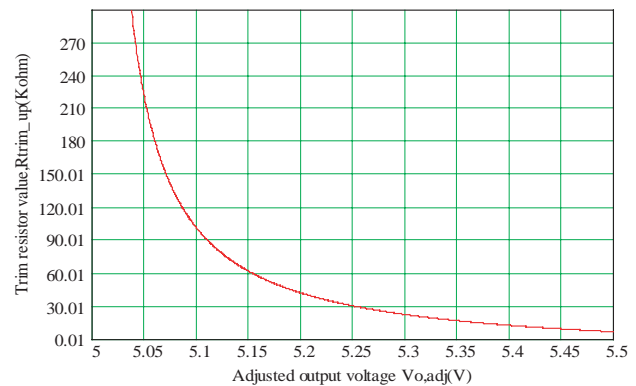

BP05SRDB-10E

Output Voltage Set-Point Adjustment

SRDB-10E33x Trim Resistor Calculation

$$R_{trim_down} = \left(\frac{7.964}{V_o - V_{o,adj}} - 6.82 \right) K\Omega$$

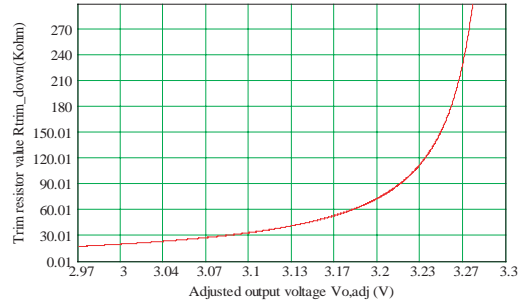

$$R_{trim_up} = \left(\frac{2.536}{V_{o,adj} - V_o} - 3.65 \right) K\Omega$$

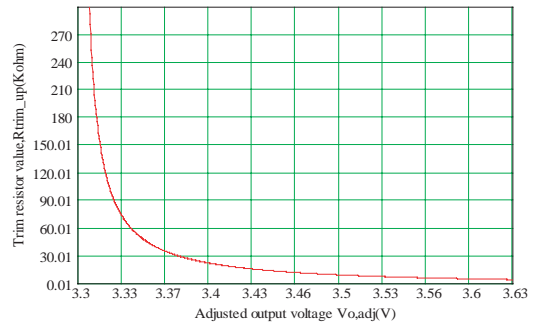

SRDB-10E25x Trim Resistor Calculation

$$R_{trim_down} = \left(\frac{7.568}{V_o - V_{o,adj}} - 14.43 \right) K\Omega$$

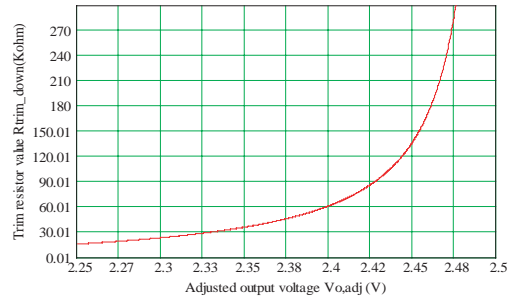

$$R_{trim_up} = \left(\frac{3.544}{V_{o,adj} - V_o} - 10 \right) K\Omega$$

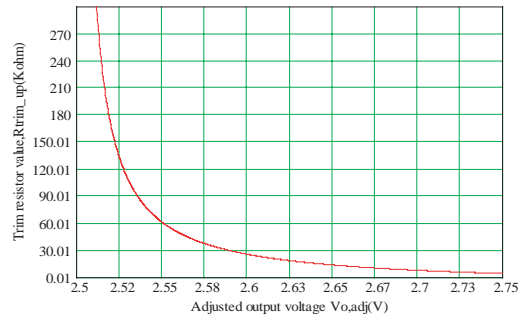

NON-ISOLATED DC/DC CONVERTERS

4.5V – 13.2V Input / 1.0V – 5.0V Output / 10A



BP05SRDB-10E

Output Voltage Set-Point Adjustment

SRDB-10E18x Trim Resistor Calculation

$$R_{trim_down} = \left(\frac{3.869}{V_o - V_{o,adj}} - 13.84 \right) K\Omega$$

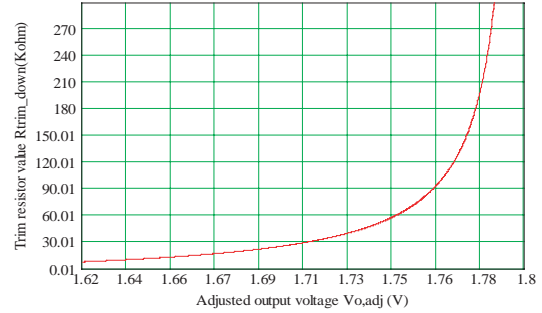

$$R_{trim_up} = \left(\frac{3.072}{V_{o,adj} - V_o} - 10 \right) K\Omega$$

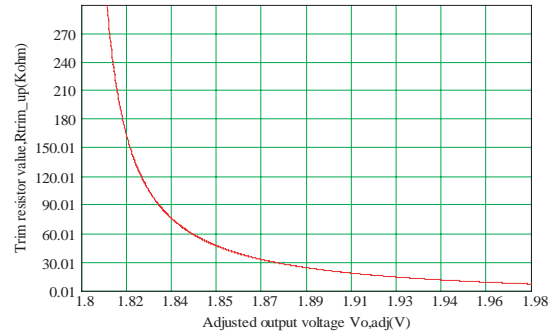

SRDB-10E15x Trim Resistor Calculation

$$R_{trim_down} = \left(\frac{2.716}{V_o - V_{o,adj}} - 11.71 \right) K\Omega$$

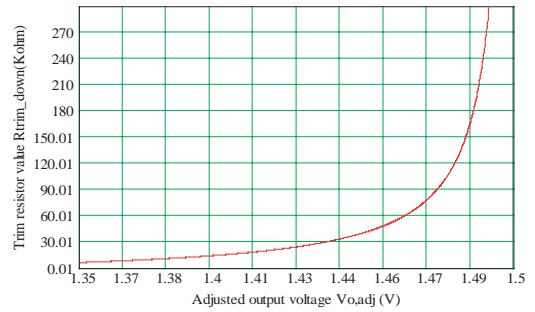

$$R_{trim_up} = \left(\frac{3.072}{V_{o,adj} - V_o} - 7.87 \right) K\Omega$$

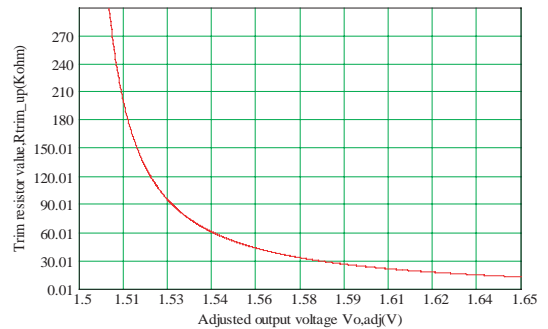

©2005 Bel Fuse Inc. Specifications subject to change without notice. 03.05

BP05SRDB-10E

Output Voltage Set-Point Adjustment

SRDB-10E12x Trim Resistor Calculation

$$R_{trim_down} = \left(\frac{1.562}{V_o - V_{o,adj}} - 8.48 \right) K\Omega$$

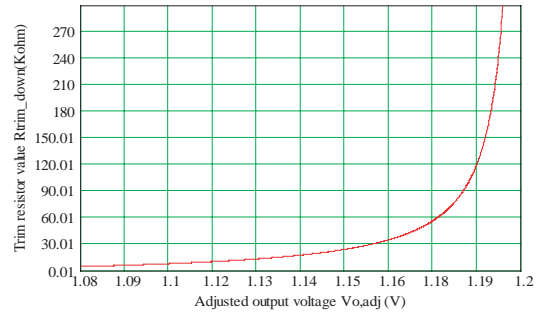

$$R_{trim_up} = \left(\frac{3.072}{V_{o,adj} - V_o} - 4.64 \right) K\Omega$$

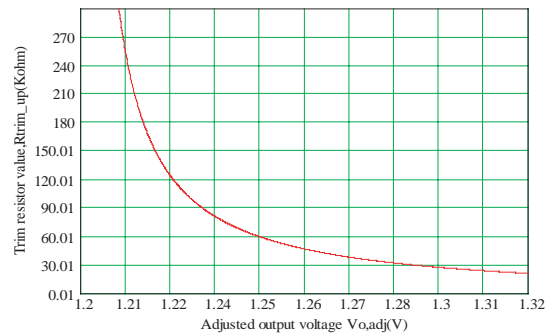

SRDB-10E10x Trim Resistor Calculation

$$R_{trim_down} = \left(\frac{0.658}{V_o - V_{o,adj}} - 4.17 \right) K\Omega$$

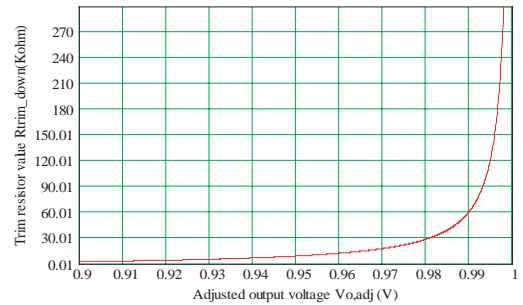

$$R_{trim_up} = \left(\frac{2.536}{V_{o,adj} - V_o} - 1 \right) K\Omega$$

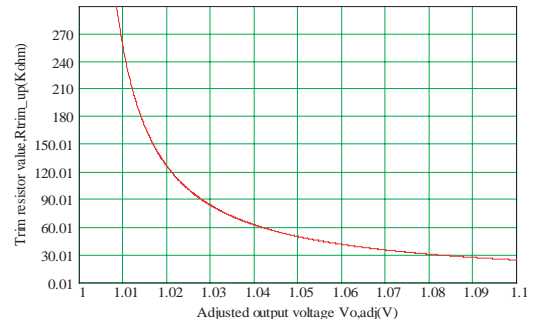

NON-ISOLATED DC/DC CONVERTERS

4.5V – 13.2V Input / 1.0V – 5.0V Output / 10A



BP05SRDB-10E

Mechanical

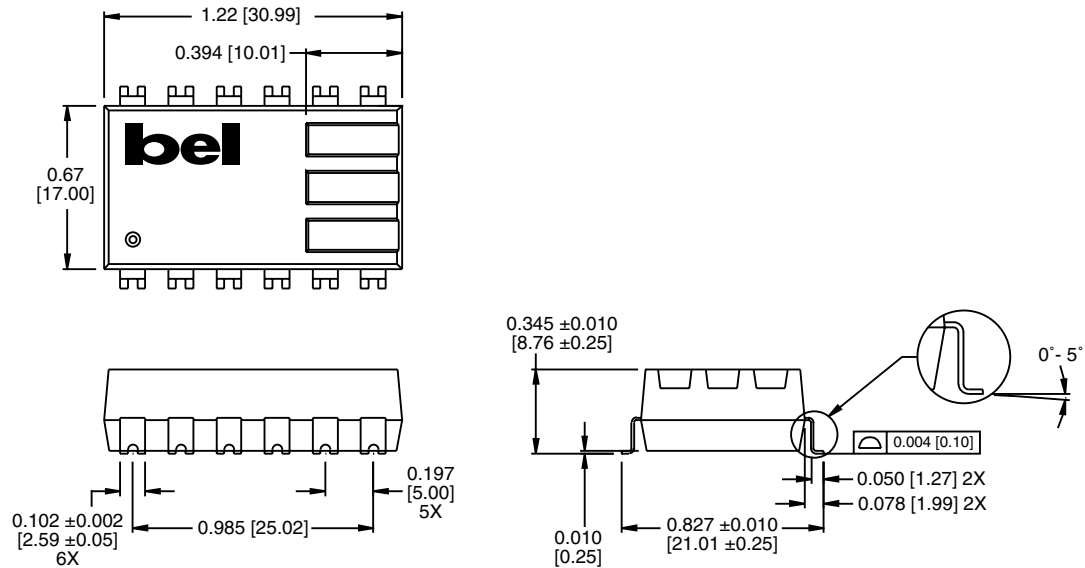

Pin	Function
1	Ground
2	Ground
3	Ground
4	Ground
5	+Vin
6	+Vin
7	Trim
8	Remote On/Off
9	Remote Sense (+)
10	+Vo
11	+Vo
12	+Vo

Dimensions are in inches [millimeters].
Standard dimension tolerance is ± 0.005 [0.13] unless otherwise noted.

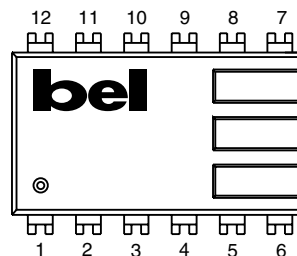

RoHS Compliance

Complies with the European Directive 2002/95/EC, calling for the elimination of lead and other hazardous substances from electronic products. These parts are not however compatible with the higher temperatures associated with lead free solder processes and must be soldered using a reflow profile with a peak temperature of no more than 240°C.



©2005 Bel Fuse Inc. Specifications subject to change without notice. 03.05

CORPORATE

Bel Fuse Inc.
206 Van Vorst Street
Jersey City, NJ 07302
Tel 201-432-0463
Fax 201-432-9542
www.belfuse.com

FAR EAST

Bel Fuse Ltd.
8F / 8 Luk Hop Street
San Po Kong
Kowloon, Hong Kong
Tel 852-2328-5515
Fax 852-2352-3706
www.belfuse.com

EUROPE

Bel Fuse Europe Ltd.
Preston Technology Management Centre
Marsh Lane, Suite G7, Preston
Lancashire, PR1 8UD, U.K.
Tel 44-1772-556601
Fax 44-1772-888366
www.belfuse.com

Looking for pricing, stock, or lifecycle information?

Click below to explore more details on WIN SOURCE:

 [View SRDB-10E33HR on WIN SOURCE](#)

 [Bel Fuse Inc. Information](#)

Optimize Your Supply Chain with WIN SOURCE Solutions

-  Global Sourcing Solution
-  Obsolete Management
-  Cost Control Management
-  Shortage Management
-  Alternative Solution
-  Excess Inventory Management