



**THE DATASHEET OF  
SQ24T03150-PAA0**





### Features

- RoHS lead-free solder and lead-solder-exempted products are available
- Delivers up to 3.3 A @ 15 V
- Industry-standard quarter-brick pinout
- Extremely small footprint: 0.896" x 2.30" (2.06 in<sup>2</sup>), 40% smaller than conventional quarter-bricks
- Higher current capability at elevated temperatures than most competitors' quarter-bricks
- Onboard input differential LC-filter
- High efficiency – no heat sink required
- Start-up into pre-biased output
- No minimum load required
- Available in through-hole and SM packages
- Low profile: 0.274" (6.96 mm)
- Low weight: 0.53 oz (15 g)
- Meets Basic insulation requirements
- Fixed-frequency operation
- Fully protected
- Remote output sense
- Output voltage trim range: +10%/–20% with Industry-standard trim equations
- High reliability: MTBF of 3.4 million hours, calculated per Telcordia TR-332, Method I Case 1
- Positive or negative logic ON/OFF option
- CAN/CSA C22.2, No. 60950-1/UL 60950-1 Second Edition, IEC/EN 60950-1 Second Edition safety approved
- Meets conducted emissions requirements of FCC Class B and EN55022 Class B with external filter
- All materials meet 94, V-0 flammability rating

### Applications

- Telecommunications
- Data communications
- Wireless
- Servers

### Description

The SemiQ™ Family of DC-DC converters provide a high-efficiency single output in a size that is only 60% of industry-standard quarter-bricks, while preserving the same pinout and functionality.

In high-temperature environments, the thermal performance of SemiQ™ converters exceeds that of most competitors' quarter-bricks. This is accomplished through the use of patent pending circuit, packaging and processing techniques to achieve ultra-high efficiency, excellent thermal management, and a very low body profile.

Low body profile and the preclusion of heat sinks minimize airflow shadowing, thus enhancing cooling for downstream devices. The use of 100% automation for assembly, coupled with advanced electrical and thermal design results in a product with extremely high reliability.

With a standard pinout and trim equations, the SQ24 Series converters are perfect drop-in replacements for existing quarter-brick designs. Inclusion of this converter in new designs can result in significant board space and cost savings. The device is also available in a surface mount package.

In both cases the designer can expect reliability improvement over other available converters because of the SQ24 Series' optimized thermal efficiency.



## Electrical Specifications

Conditions:  $T_A=25\text{ }^\circ\text{C}$ , Airflow=300 LFM (1.5 m/s),  $V_{in}=24\text{ VDC}$ , All output voltages, unless otherwise specified.

PARAMETER	NOTES	MIN	TYP	MAX	UNITS
<b>ABSOLUTE MAXIMUM RATING</b>					
Input Voltage	Continuous	0		40	VDC
Operating Ambient Temperature		-40		85	$^\circ\text{C}$
Storage Temperature		-55		125	$^\circ\text{C}$
<b>INPUT CHARACTERISTICS</b>					
Operating Input Voltage Range		19	24	36	VDC
Input Under Voltage Lockout	Non-latching				
Turn-on Threshold		16	17	17.5	VDC
Turn-off Threshold		15	16	16.5	VDC
<b>ISOLATION CHARACTERISTICS</b>					
I/O Isolation		2000			VDC
Isolation Capacitance:			230		pF
Isolation Resistance		10			$\text{M}\Omega$
<b>FEATURE CHARACTERISTICS</b>					
Switching Frequency			415		kHz
Output Voltage Trim Range <sup>1</sup>	Industry-std. equations	-20		+10	%
Remote Sense Compensation <sup>1</sup>	Percent of $V_{OUT(NOM)}$			+10	%
Output Over-Voltage Protection	Non-latching	117	125	140	%
Auto-Restart Period	Applies to all protection features		100		ms
Turn-On Time			4		ms
<b>ON/OFF Control (Positive Logic)</b>					
Converter Off		-20		0.8	VDC
Converter On		2.4		20	VDC
<b>ON/OFF Control (Negative Logic)</b>					
Converter Off		2.4		20	VDC
Converter On		-20		0.8	VDC

Additional Notes:

- Vout can be increased up to 10% via the sense leads or up to 10% via the trim function for  $V_{in} > 21\text{ V}$ ; however total output voltage trim from all sources should not exceed 10% of  $V_{OUT(NOM)}$ , in order to insure specified operation of overvoltage protection circuitry. Vout can be increased up to 5% for  $V_{in} > 20\text{ V}$ .



## Electrical Specifications (continued)

Conditions:  $T_A=25\text{ }^\circ\text{C}$ , Airflow=300 LFM (1.5 m/s),  $V_{in}=24\text{ VDC}$ ,  $V_{out}=15\text{ VDC}$  unless otherwise specified.

PARAMETER	NOTES	MIN	TYP	MAX	UNITS
<b>INPUT CHARACTERISTICS</b>					
Maximum Input Current	3.3 ADC, 15 VDC Out @ 19 VDC In			3.2	ADC
Input Stand-by Current	$V_{in} = 24\text{ V}$ , converter disabled		3		mADC
Input No Load Current (0 load on the output)	$V_{in} = 24\text{ V}$ , converter enabled		105		mADC
Input Reflected-Ripple Current	25MHz bandwidth		7		$\text{mA}_{\text{PK-PK}}$
Input Voltage Ripple Rejection	120Hz		TBD		dB
<b>OUTPUT CHARACTERISTICS</b>					
Output Voltage Set Point (no load)		14.850	15.000	15.150	VDC
Output Regulation					
Over Line			$\pm 4$	$\pm 10$	mV
Over Load			$\pm 4$	$\pm 10$	mV
Output Voltage Range	Over line, load and temperature <sup>2</sup>	14.775		15.225	VDC
Output Ripple and Noise - 25MHz bandwidth	Full load + 10 $\mu\text{F}$ tantalum + 1 $\mu\text{F}$ ceramic		110	140	$\text{mV}_{\text{PK-PK}}$
External Load Capacitance	Plus full load (resistive)			1000	$\mu\text{F}$
Output Current Range		0		3.3	ADC
Current Limit Inception	Non-latching		4	4.5	ADC
Peak Short-Circuit Current	Non-latching. Short=10m $\Omega$		12	15	A
RMS Short-Circuit Current	Non-latching		0.75		Arms
<b>DYNAMIC RESPONSE</b>					
Load Change 25% of Iout Max, di/dt = 0.1 A/ $\mu\text{S}$	$C_o = 1\text{ } \mu\text{F}$ ceramic		200		mV
	$C_o = 47\text{ } \mu\text{F}$ tant. + 1 $\mu\text{F}$ ceramic		150		mV
Setting Time to 1%					
Load Change (25%-75%-25%), di/dt = 5 A/ $\mu\text{S}$	$C_o = 47\text{ } \mu\text{F}$ tant. + 1 $\mu\text{F}$ ceramic		150		$\mu\text{s}$
<b>EFFICIENCY</b>					
100% Load			89		%
50% Load			88		%

Additional Notes: 2.  $-40\text{ }^\circ\text{C}$  to  $85\text{ }^\circ\text{C}$ .



## Operation

### Input and Output Impedance

These power converters have been designed to be stable with no external capacitors when used in low inductance input and output circuits.

However, in many applications, the inductance associated with the distribution from the power source to the input of the converter can affect the stability of the converter. The addition of a 100  $\mu\text{F}$  electrolytic capacitor with an ESR  $< 1 \Omega$  across the input helps ensure stability of the converter. In many applications, the user has to use decoupling capacitance at the load. The power converter will exhibit stable operation with external load capacitance up to 1000  $\mu\text{F}$ .

### ON/OFF (Pin 2)

The ON/OFF pin is used to turn the power converter on or off remotely via a system signal. There are two remote control options available, positive logic and negative logic and both are referenced to  $V_{in(-)}$ . Typical connections are shown in Fig. A.

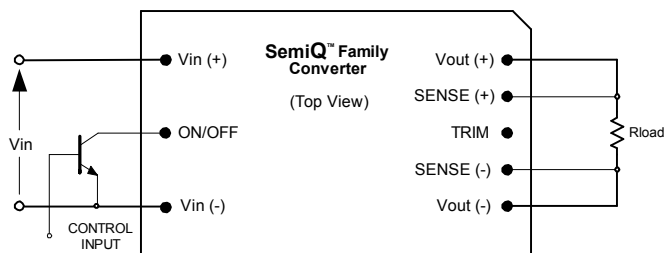

**Fig. A:** Circuit configuration for ON/OFF function.

The positive logic version turns on when the ON/OFF pin is at logic high and turns off when at logic low. The converter is on when the ON/OFF pin is left open.

The negative logic version turns on when the pin is at logic low and turns off when the pin is at logic high. The ON/OFF pin can be hard wired directly to  $V_{in(-)}$  to enable automatic power up of the converter without the need of an external control signal.

The ON/OFF pin is internally pulled-up to 5 V through a resistor. A mechanical switch, open collector transistor, or FET can be used to drive the input of the ON/OFF pin. The device must be capable of sinking up to 0.2 mA at a low level voltage of  $\leq 0.8 \text{ V}$ . An external voltage source of  $\pm 20 \text{ V}$  max. may be connected directly to the ON/OFF input, in which case it should be capable of sourcing or

sinking up to 1 mA depending on the signal polarity. See the Start-up Information section for system timing waveforms associated with use of the ON/OFF pin.

### Remote Sense (Pins 5 and 7)

The remote sense feature of the converter compensates for voltage drops occurring between the output pins of the converter and the load. The SENSE(-) (Pin 5) and SENSE(+) (Pin 7) pins should be connected at the load or at the point where regulation is required (see Fig. B).

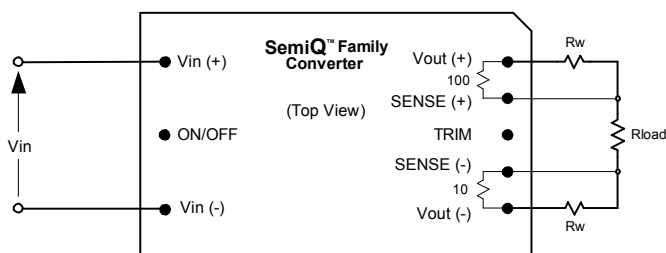

**Fig. B:** Remote sense circuit configuration.

If remote sensing is not required, the SENSE(-) pin must be connected to the  $V_{out(-)}$  pin (Pin 4), and the SENSE(+) pin must be connected to the  $V_{out(+)}$  pin (Pin 8) to ensure the converter will regulate at the specified output voltage. If these connections are not made, the converter will deliver an output voltage that is slightly higher than the specified value.

Because the sense leads carry minimal current, large traces on the end-user board are not required. However, sense traces should be located close to a ground plane to minimize system noise and insure optimum performance. When wiring discretely, twisted pair wires should be used to connect the sense lines to the load to reduce susceptibility to noise.

The converter's output over-voltage protection (OVP) senses the voltage across  $V_{out(+)}$  and  $V_{out(-)}$ , and not across the sense lines, so the resistance (and resulting voltage drop) between the output pins of the converter and the load should be minimized to prevent unwanted triggering of the OVP.

When utilizing the remote sense feature, care must be taken not to exceed the maximum allowable output power capability of the converter, equal to the product of the nominal output voltage and the allowable output current for the given conditions.



When using remote sense, the output voltage at the converter can be increased by as much as 10% above the nominal rating in order to maintain the required voltage across the load. Therefore, the designer must, if necessary, decrease the maximum current (originally obtained from the derating curves) by the same percentage to ensure the converter's actual output power remains at or below the maximum allowable output power.

**Output Voltage Adjust /TRIM (Pin 6)**

The converter's output voltage can be adjusted up 10% or down 20% relative to the rated output voltage by the addition of an externally connected resistor. Trim up to 10% is guaranteed only at  $V_{in} \geq 21$  V, and to 5% is guaranteed only at  $V_{in} \geq 20$  V.

The TRIM pin should be left open if trimming is not being used. To minimize noise pickup, a 0.1  $\mu$ F capacitor is connected internally between the TRIM and SENSE(-) pins.

To increase the output voltage, refer to Fig. C. A trim resistor,  $R_{T-INCR}$ , should be connected between the TRIM (Pin 6) and SENSE(+) (Pin 7), with a value of:

$$R_{T-INCR} = \frac{5.11(100 + \Delta)V_{O-NOM} - 626}{1.225\Delta} - 10.22 \text{ [k}\Omega\text{]}$$

where,

$R_{T-INCR}$  = Required value of trim-up resistor k $\Omega$

$V_{O-NOM}$  = Nominal value of output voltage [V]

$$\Delta = \frac{(V_{O-REQ} - V_{O-NOM})}{V_{O-NOM}} \times 100 \text{ [%]}$$

$V_{O-REQ}$  = Desired (trimmed) output voltage [V].

When trimming up, care must be taken not to exceed the converter's maximum allowable output power. See previous section for a complete discussion of this requirement.

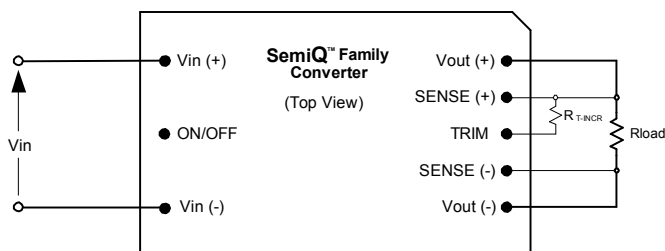

**Fig. C:** Configuration for increasing output voltage.

To decrease the output voltage (Fig. D), a trim resistor,  $R_{T-DECR}$ , should be connected between the TRIM (Pin 6) and SENSE(-) (Pin 5), with a value of:

$$R_{T-DECR} = \frac{511}{|\Delta|} - 10.22 \text{ [k}\Omega\text{]}$$

where,

$R_{T-DECR}$  = Required value of trim-down resistor [k $\Omega$ ]  
 and  $\Delta$  is as defined above.

Note: The above equations for calculation of trim resistor values match those typically used in conventional industry-standard, quarter-bricks and one-eighth brick. For more information, see Application Note 103.

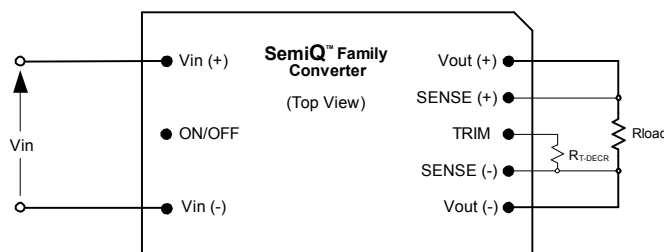

**Fig. D:** Configuration for decreasing output voltage.

Trimming/sensing beyond 110% of the rated output voltage is not an acceptable design practice, as this condition could cause unwanted triggering of the output overvoltage protection (OVP) circuit. The designer should ensure that the difference between the voltages across the converter's output pins and its sense pins does not exceed 10% of  $V_{OUT(NOM)}$ , or:

$$[V_{OUT(+)} - V_{OUT(-)}] - [V_{SENSE(+)} - V_{SENSE(-)}] \leq V_{O-NOM} \times 10\% \text{ [V]}$$

This equation is applicable for any condition of output sensing and/or output trim.

**Protection Features**

**Input Undervoltage Lockout**

Input undervoltage lockout is standard with this converter. The converter will shut down when the input voltage drops below a pre-determined voltage.

The input voltage must be at least 17.5 V for the converter to turn on. Once the converter has been turned on, it will shut off when the input voltage drops below 15 V. This feature is beneficial in



preventing deep discharging of batteries used in telecom applications.

#### **Output Overcurrent Protection (OCP)**

The converter is protected against overcurrent or short-circuit conditions. Upon sensing an overcurrent condition, the converter will switch to constant current operation and thereby begin to reduce output voltage. When the output voltage drops below 50% of the nominal value of output voltage, the converter will shut down.

Once the converter has shut down, it will attempt to restart nominally every 100 ms with a typical 1-2% duty cycle. The attempted restart will continue indefinitely until the overload or short circuit conditions are removed or the output voltage rises above 50% of its nominal value.

#### **Output Overvoltage Protection (OVP)**

The converter will shut down if the output voltage across Vout(+) (Pin 8) and Vout(-) (Pin 4) exceeds the threshold of the OVP circuitry. The OVP circuitry contains its own reference, independent of the output voltage regulation loop. Once the converter has shut down, it will attempt to restart every 100 ms until the OVP condition is removed.

#### **Overtemperature Protection (OTP)**

The converter will shut down under an overtemperature condition to protect itself from overheating caused by operation outside the thermal derating curves, or operation in abnormal conditions such as system fan failure. After the converter has cooled to a safe operating temperature, it will automatically restart.

#### **Safety Requirements**

The converters meet North American and International safety regulatory requirements per CAN/CSA C22.2, No. 60950-1/UL 60950-1 Second Edition, IEC/EN 60950-1 Second Edition safety approved. Basic Insulation is provided between input and output.

To comply with safety agencies requirements, an input line fuse must be used external to the converter. A 6 A fuse is recommended for use with this product.

If one input fuse is used for a group of modules, the maximum fuse rating should not exceed 15 A. SQ converters are UL approved with up to a 15 A fuse.

#### **Electromagnetic Compatibility (EMC)**

EMC requirements must be met at the end-product system level, as no specific standards dedicated to EMC characteristics of board mounted component dc-dc converters exist. However, Power-One tests its converters to several system level standards, primary of which is the more stringent EN55022, *Information technology equipment - Radio disturbance characteristics - Limits and methods of measurement*.

With the addition of a simple external filter (see application notes), all versions of the SQ Series of converters pass the requirements of Class B conducted emissions per EN55022 and FCC, and meet at a minimum, Class A radiated emissions per EN 55022 and Class B per FCC Title 47CFR, Part 15-J. Please contact Power-One Applications Engineering for details of this testing.



## Characterization

### General Information

The converter has been characterized for many operational aspects, to include thermal derating (maximum load current as a function of ambient temperature and airflow) for vertical and horizontal mounting, efficiency, start-up and shutdown parameters, output ripple and noise, transient response to load step-change, overload, and short circuit.

The following pages contain specific plots or waveforms associated with the converter. Additional comments for specific data are provided below.

### Test Conditions

All data presented were taken with the converter soldered to a test board, specifically a 0.060" thick printed wiring board (PWB) with four layers. The top and bottom layers were not metalized. The two inner layers, comprising two-ounce copper, were used to provide traces for connectivity to the converter.

The lack of metalization on the outer layers as well as the limited thermal connection ensured that heat transfer from the converter to the PWB was minimized. This provides a worst-case but consistent scenario for thermal derating purposes.

All measurements requiring airflow were made in vertical and horizontal wind tunnels using Infrared (IR) thermography and thermocouples for thermometry.

Ensuring components on the converter do not exceed their ratings is important to maintaining high reliability. If one anticipates operating the converter at or close to the maximum loads specified in the derating curves, it is prudent to check actual operating temperatures in the application. Thermographic imaging is preferable; if this capability is not available, then thermocouples may be used. Power-One recommends the use of AWG #40 gauge thermocouples to ensure measurement accuracy. Careful routing of the thermocouple leads will further minimize measurement error. Refer to Figure H for optimum measuring thermocouple location.

### Thermal Derating

Load current vs. ambient temperature and airflow rates are given in Fig. 1 to Fig. 4 for through-hole and surface mount version. Ambient temperature was varied between 25°C and 85°C, with airflow rates from 30 to 500 LFM (0.15 to 2.5 m/s), and vertical and horizontal converter mounting.

For each set of conditions, the maximum load current was defined as the lowest of:

- (i) The output current at which either any FET junction temperature did not exceed a maximum specified temperature (120 °C) as indicated by the thermographic image, or
- (ii) The nominal rating of the converter (3.3 A).

During normal operation, derating curves with maximum FET temperature less than or equal to 120 °C should not be exceeded. Temperature on the PCB at the thermocouple location shown in Fig. H should not exceed 118 °C in order to operate inside the derating curves.

### Efficiency

Fig. 5 shows the efficiency vs. load current plot for ambient temperature of 25 °C, airflow rate of 300 LFM (1.5 m/s) with vertical mounting and input voltages of 18 V, 24 V, and 36 V. Also, a plot of efficiency vs. load current, as a function of ambient temperature with  $V_{in} = 24$  V, airflow rate of 200 LFM (1 m/s) with vertical mounting is shown in Fig. 6.

### Power Dissipation

Fig. 7 shows the power dissipation vs. load current plot for  $T_a = 25$  °C, airflow rate of 300 LFM (1.5 m/s) with vertical mounting and input voltages of 18 V, 24 V, and 36 V. Also, a plot of power dissipation vs. load current, as a function of ambient temperature with  $V_{in} = 24$  V, airflow rate of 200 LFM (1 m/s) with vertical mounting is shown in Fig. 8.

### Start-up

Output voltage waveforms, during the turn-on transient using the ON/OFF pin for full rated load currents (resistive load) are shown without and with external load capacitance in Fig. 9 and Fig. 10, respectively.

### Ripple and Noise

Fig. 13 shows the output voltage ripple waveform, measured at full rated load current with a 10  $\mu$ F tantalum and 1  $\mu$ F ceramic capacitor across the output. Note that all output voltage waveforms are measured across a 1  $\mu$ F ceramic capacitor.

The input reflected ripple current waveforms are obtained using the test setup shown in Fig. 14. The



corresponding waveforms are shown in Fig. 15 and Fig. 16.

For the condition,  $(t_2 - t_1) \leq 100$  ms, the total converter start-up time  $(t_5 - t_2)$  is typically 104 ms. For  $(t_2 - t_1) > 100$  ms, start-up will be typically 4 ms after release of ON/OFF pin.

**Start-up Information (using negative ON/OFF)**

**Scenario #1: Initial Start-up From Bulk Supply**  
 ON/OFF function enabled, converter started via application of  $V_{IN}$ . See Figure E.

Time	Comments
$t_0$	ON/OFF pin is ON; system front end power is toggled on, $V_{IN}$ to converter begins to rise.
$t_1$	$V_{IN}$ crosses Under-Voltage Lockout protection circuit threshold; converter enabled.
$t_2$	Converter begins to respond to turn-on command (converter turn-on delay).
$t_3$	Converter $V_{OUT}$ reaches 100% of nominal value. For this example, the total converter start-up time $(t_3 - t_1)$ is typically 4 ms.

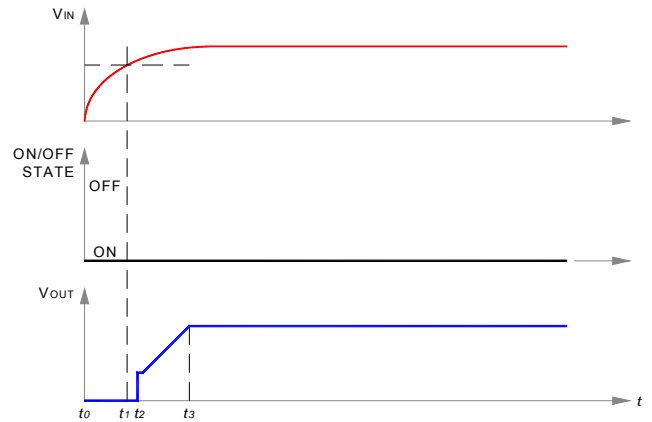

**Fig. E: Start-up scenario #1**

**Scenario #2: Initial Start-up Using ON/OFF Pin**  
 With  $V_{IN}$  previously powered, converter started via ON/OFF pin. See Figure F.

Time	Comments
$t_0$	$V_{INPUT}$ at nominal value.
$t_1$	Arbitrary time when ON/OFF pin is enabled (converter enabled).
$t_2$	End of converter turn-on delay.
$t_3$	Converter $V_{OUT}$ reaches 100% of nominal value. For this example, the total converter start-up time $(t_3 - t_1)$ is typically 4 ms.

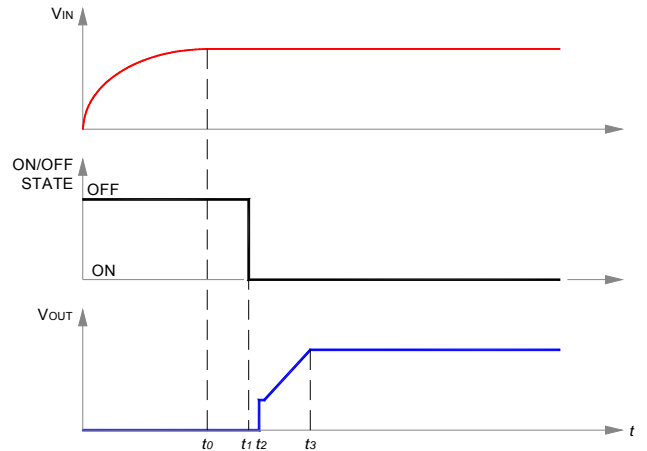

**Fig. F: Start-up scenario #2.**

**Scenario #3: Turn-off and Restart Using ON/OFF Pin**  
 With  $V_{IN}$  previously powered, converter is disabled and then enabled via ON/OFF pin. See Figure G.

Time	Comments
$t_0$	$V_{IN}$ and $V_{OUT}$ are at nominal values; ON/OFF pin ON.
$t_1$	ON/OFF pin arbitrarily disabled; converter output falls to zero; turn-on inhibit delay period (100 ms typical) is initiated, and ON/OFF pin action is internally inhibited.
$t_2$	ON/OFF pin is externally re-enabled. If $(t_2 - t_1) \leq 100$ ms, external action of ON/OFF pin is locked out by start-up inhibit timer. If $(t_2 - t_1) > 100$ ms, ON/OFF pin action is internally enabled.
$t_3$	Turn-on inhibit delay period ends. If ON/OFF pin is ON, converter begins turn-on; if off, converter awaits ON/OFF pin ON signal; see Figure F.
$t_4$	End of converter turn-on delay.
$t_5$	Converter $V_{OUT}$ reaches 100% of nominal value.

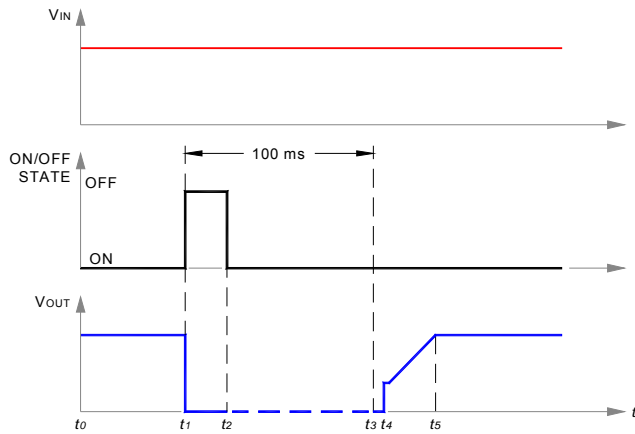
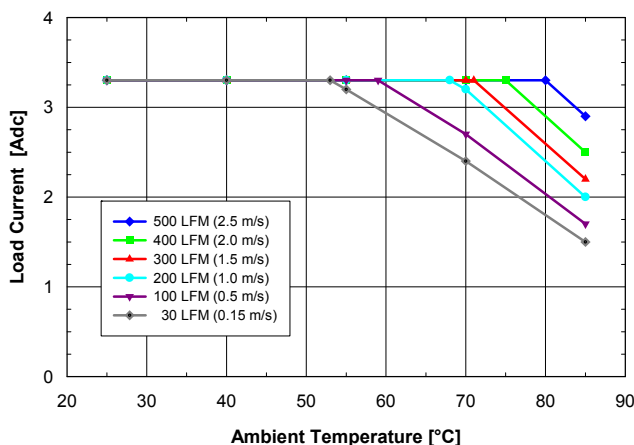
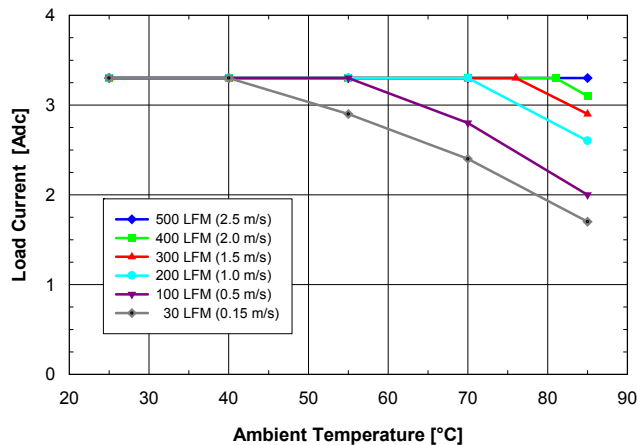

Fig. G: Start-up scenario #3.



**Fig. 1:** Available load current vs. ambient air temperature and airflow rates for **SQ24T03150** converter with **B** height pins mounted vertically with  $V_{in} = 24\text{ V}$ , air flowing from pin 3 to pin 1 and maximum FET temperature  $\leq 120\text{ }^{\circ}\text{C}$ .



**Fig. 2:** Available load current vs. ambient air temperature and airflow rates for **SQ24T03150** converter with **B** height pins mounted horizontally with  $V_{in} = 24\text{ V}$ , air flowing from pin 3 to pin 1 and maximum FET temperature  $\leq 120\text{ }^{\circ}\text{C}$ .

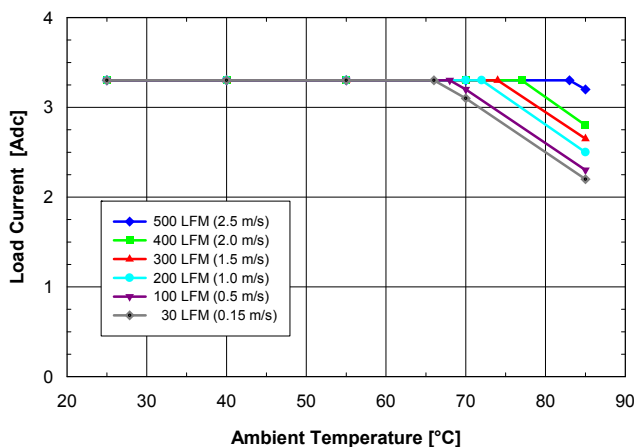

**Fig. 3:** Available load current vs. ambient temperature and airflow rates for **SQ24S03150** converter mounted vertically with  $V_{in} = 24\text{ V}$ , air flowing from pin 3 to pin 1 and maximum FET temperature  $\leq 120\text{ }^{\circ}\text{C}$ .

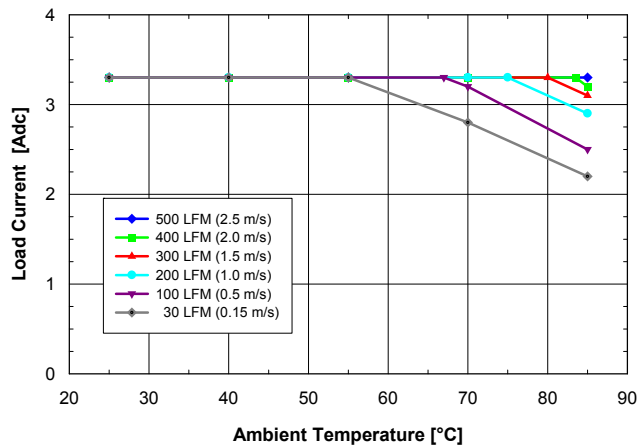

**Fig. 4:** Available load current vs. ambient temperature and airflow rates for **SQ24S03150** converter mounted horizontally with  $V_{in} = 24\text{ V}$ , air flowing from pin 3 to pin 1 and maximum FET temperature  $\leq 120\text{ }^{\circ}\text{C}$ .

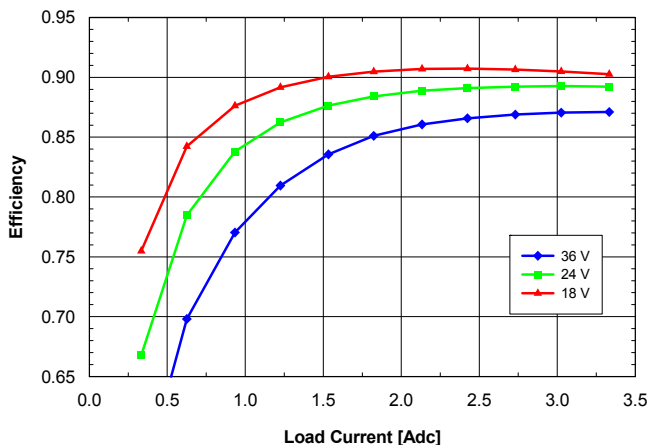

**Fig. 5:** Efficiency vs. load current and input voltage for **SQ24T/S03150** converter mounted vertically with air flowing from pin 3 to pin 1 at a rate of 300 LFM (1.5 m/s) and  $T_a = 25^\circ\text{C}$ .

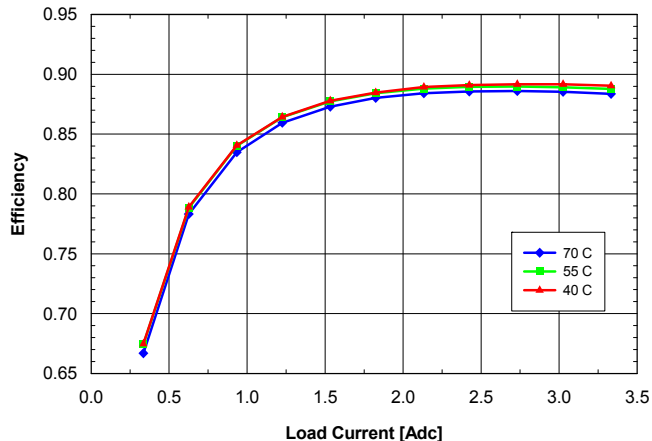

**Fig. 6:** Efficiency vs. load current and ambient temperature for **SQ24T/S03150** converter mounted vertically with  $V_{in} = 24\text{ V}$  and air flowing from pin 3 to pin 1 at a rate of 200 LFM (1.0 m/s).

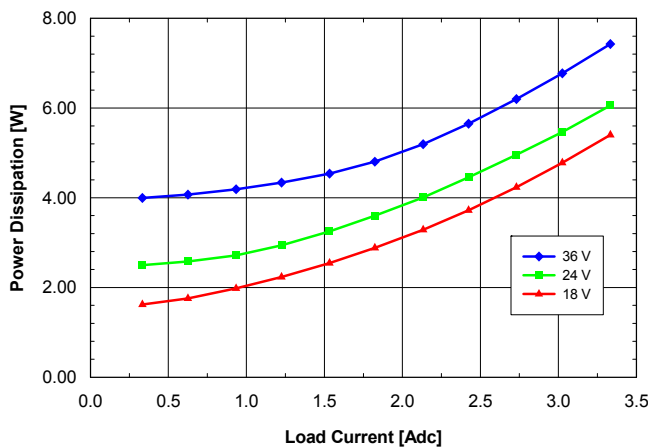

**Fig. 7:** Power dissipation vs. load current and input voltage for **SQ24T/S03150** converter mounted vertically with air flowing from pin 3 to pin 1 at a rate of 300 LFM (1.5 m/s) and  $T_a = 25^\circ\text{C}$ .

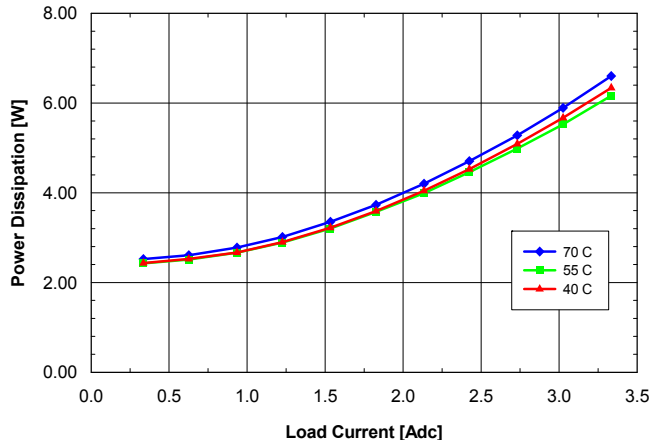

**Fig. 8:** Power dissipation vs. load current and ambient temperature for **SQ24T/S03150** converter mounted vertically with  $V_{in} = 24\text{ V}$  and air flowing from pin 3 to pin 1 at a rate of 200 LFM (1.0 m/s).

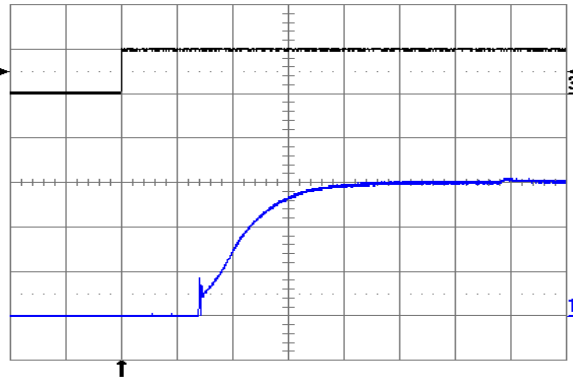

**Fig. 9:** Turn-on transient at full rated load current (resistive) with no output capacitor at  $V_{in} = 24\text{ V}$ , triggered via ON/OFF pin. Top trace: ON/OFF signal (5 V/div.). Bottom trace: output voltage (5 V/div.). Time scale: 1 ms/div.

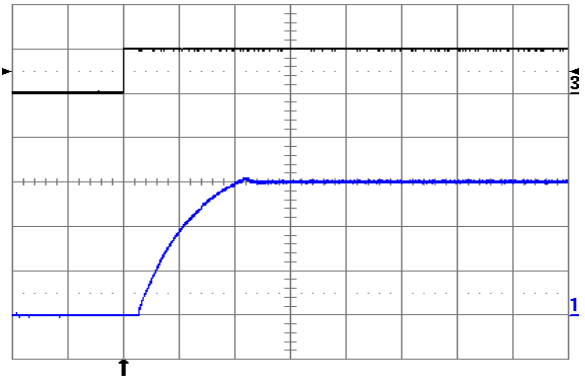

**Fig. 10:** Turn-on transient at full rated load current (resistive) plus 1,000  $\mu\text{F}$  at  $V_{in} = 24\text{ V}$ , triggered via ON/OFF pin. Top trace: ON/OFF signal (5 V/div.). Bottom trace: output voltage (5 V/div.). Time scale: 5 ms/div.

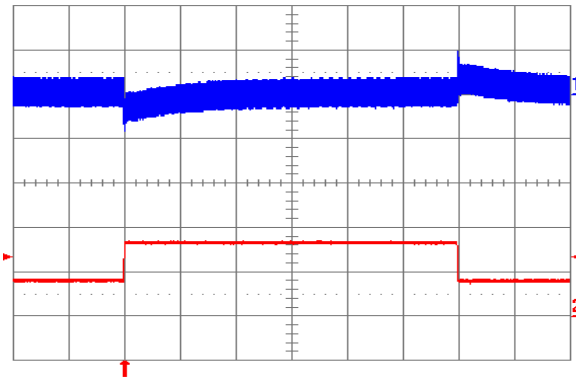

**Fig. 11:** Output voltage response to load current step-change (0.825 A – 1.65 A – 0.825 A) at  $V_{in} = 24\text{ V}$ . Top trace: output voltage (200 mV/div.). Bottom trace: load current (1 A/div.). Current slew rate: 0.1 A/ $\mu\text{s}$ .  $C_o = 1\ \mu\text{F}$  ceramic. Time scale: 0.5 ms/div.

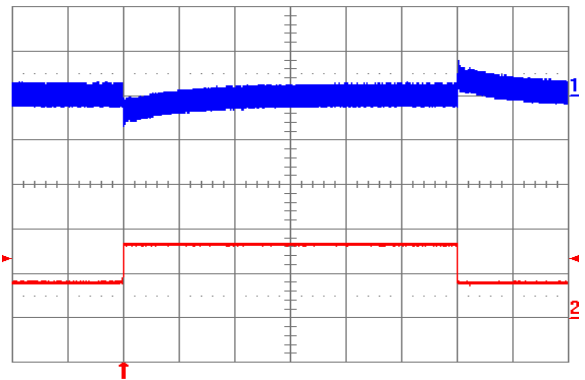

**Fig. 12:** Output voltage response to load current step-change (0.825 A – 1.65 A – 0.825 A) at  $V_{in} = 24\text{ V}$ . Top trace: output voltage (200 mV/div.). Bottom trace: load current (1 A/div.). Current slew rate: 5 A/ $\mu\text{s}$ .  $C_o = 47\ \mu\text{F}$  tantalum + 1  $\mu\text{F}$  ceramic. Time scale: 0.5 ms/div.

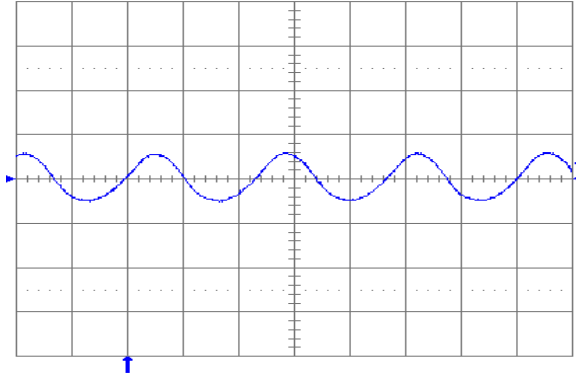

**Fig. 13:** Output voltage ripple (100 mV/div.) at full rated load current into a resistive load with  $C_o = 10 \mu\text{F}$  tantalum + 1uF ceramic and  $V_{in} = 24 \text{ V}$ . Time scale:  $1 \mu\text{s}/\text{div}$ .

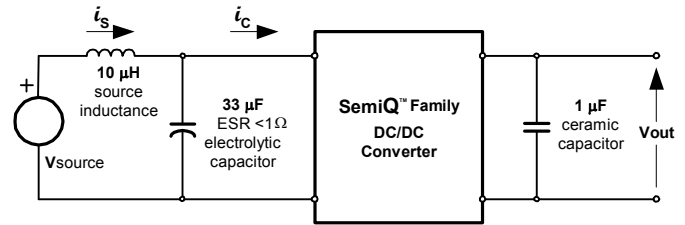

**Fig. 14:** Test setup for measuring input reflected ripple currents,  $i_c$  and  $i_s$ .

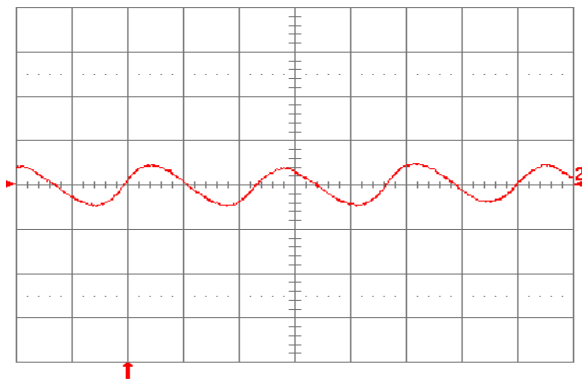

**Fig. 15:** Input reflected ripple current,  $i_c$  (100 mA/div.), measured at input terminals at full rated load current and  $V_{in} = 24 \text{ V}$ . Refer to Fig. 14 for test setup. Time scale:  $1 \mu\text{s}/\text{div}$ .

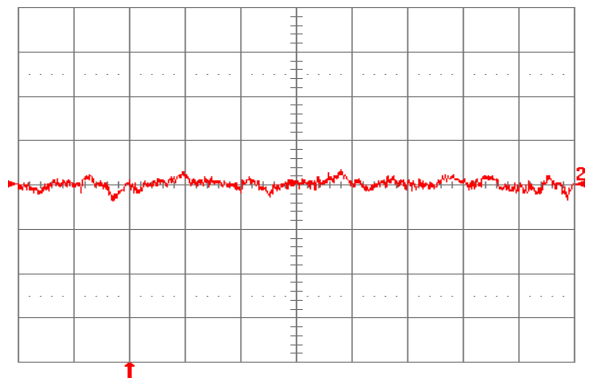

**Fig. 16:** Input reflected ripple current,  $i_s$  (10 mA/div.), measured through  $10 \mu\text{H}$  at the source at full rated load current and  $V_{in} = 24 \text{ V}$ . Refer to Fig. 14 for test setup. Time scale:  $1 \mu\text{s}/\text{div}$ .

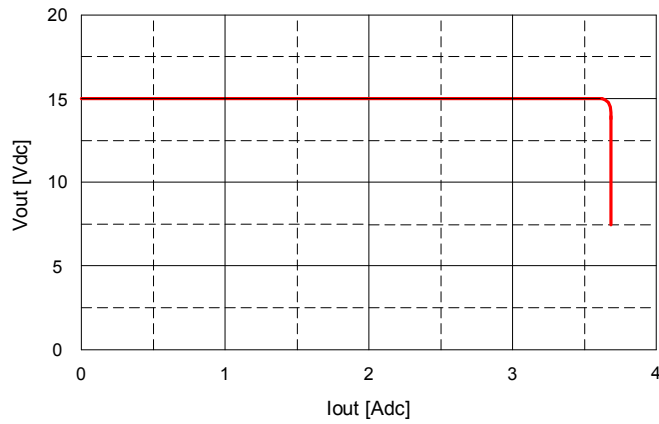

**Fig. 17:** Output voltage vs. load current showing current limit point and converter shutdown point. Input voltage has almost no effect on current limit characteristic.

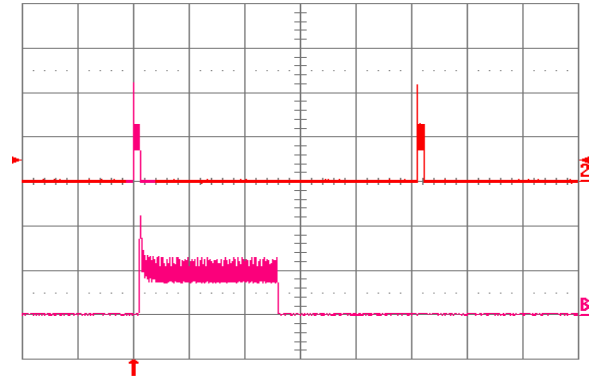

**Fig. 18:** Load current (top trace, 5 A/div., 20 ms/div.) into a 10 mΩ short circuit during restart, at Vin = 24 V. Bottom trace (5 A/div., 1 ms/div.) is an expansion of the on-time portion of the top trace.

# SQ24T/S03150 DC-DC Converter Data Sheet

## 19-36 VDC Input; 15 VDC Output @ 3.3 A



### Physical Information

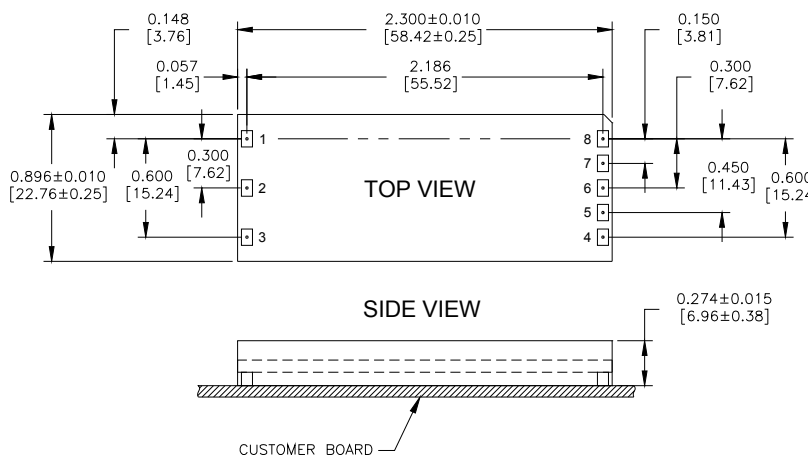

**SQ24S Pinout (Surface Mount)**

### SQ24S Platform Notes

- All dimensions are in inches [mm]
- Connector Material: Copper
- Connector Finish: Gold over Nickel
- Optional: Tin/Lead over Nickel
- Converter Weight: 0.53 oz [15 g]
- Recommended Surface-Mount Pads:  
Min. 0.080" X 0.112" [2.03 x 2.84]  
Max. 0.092" X 0.124" [2.34 x 3.15]

Pad/Pin Connections	
Pad/Pin #	Function
1	Vin (+)
2	ON/OFF
3	Vin (-)
4	Vout (-)
5	SENSE(-)
6	TRIM
7	SENSE(+)
8	Vout (+)

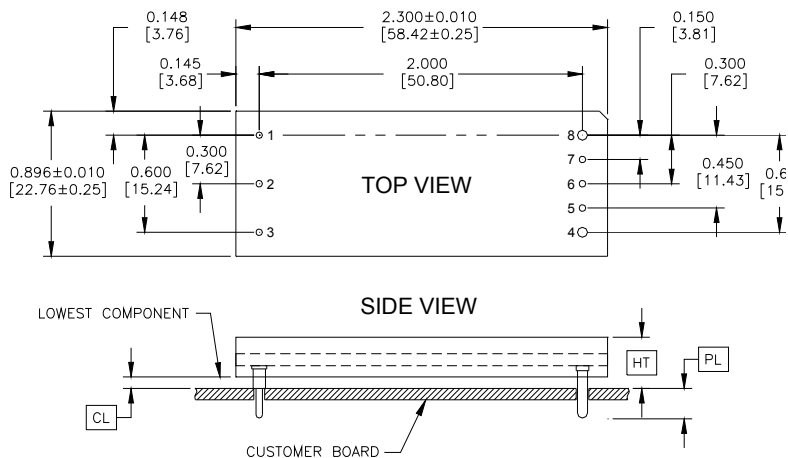

**SQ24T Pinout (Through-Hole)**

Height Option	HT (Max. Height)	CL (Min. Clearance)
	+0.000 [+0.00]	-0.038 [-0.97]
A	0.319 [8.10]	0.030 [0.77]
B	0.352 [8.94]	0.063 [1.60]
C	0.516 [13.11]	0.227 [5.77]
D	0.416 [10.57]	0.127 [3.23]
E	0.298 [7.57]	0.009 [0.23]

Pin Option	PL Pin Length
	±0.005 [±0.13]
A	0.188 [4.77]
B	0.145 [3.68]
C	0.110 [2.79]

### SQ24T Platform Notes

- All dimensions are in inches [mm]
- Pins 1-3 and 5-7 are  $\varnothing 0.040$ " [1.02] with  $\varnothing 0.078$ " [1.98] shoulder
- Pins 4 and 8 are  $\varnothing 0.062$ " [1.57] without shoulder
- Pin Material & Finish: CDA 360 (brass) with 200-300 u" matte SN over 100-150 u" Ni
- Converter Weight: 0.53 oz [15 g]

**Converter Part Numbering/Ordering Information**

Product Series <sup>1</sup>	Input Voltage	Mounting Scheme	Rated Load Current	Output Voltage		ON/OFF Logic	Maximum Height [HT]	Pin Length [PL]	Special Features	RoHS
<b>SQ</b>	<b>24</b>	<b>T</b>	<b>03</b>	<b>150</b>	<b>-</b>	<b>N</b>	<b>B</b>	<b>A</b>	<b>0</b>	
1/8 <sup>th</sup> Brick Format	19-36 V	S ⇒ Surface Mount T ⇒ Through-hole	3.3A	150 ⇒ 15V		N ⇒ Negative P ⇒ Positive	<u>SMT</u> S ⇒ 0.289" <u>Through hole</u> A ⇒ 0.319" B ⇒ 0.352" C ⇒ 0.516" D ⇒ 0.416" E ⇒ 0.298"	<u>SMT</u> 0 ⇒ 0.00" <u>Through hole</u> A ⇒ 0.188" B ⇒ 0.145" C ⇒ 0.110"	0 ⇒ STD	No Suffix ⇒ RoHS lead-solder-exemption compliant  G ⇒ RoHS compliant for all six substances

The example above describes P/N SQ24T03150-NBA0: 19-36 V input, through-hole mounting, 3.3 A @ 15 V output, negative ON/OFF logic, a maximum height of 0.352", a through the board pin length of 0.188", and RoHS lead-solder-exemption compliancy. Please consult factory regarding availability of a specific version.

1. All possible option combinations are not necessarily available for every model. Contact Customer Service to confirm availability.

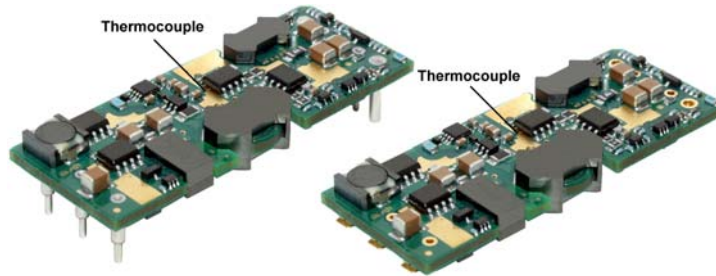

**Fig. H:** Location of the thermocouple for thermal testing.

NUCLEAR AND MEDICAL APPLICATIONS - Power-One products are not designed, intended for use in, or authorized for use as critical components in life support systems, equipment used in hazardous environments, or nuclear control systems without the express written consent of the respective divisional president of Power-One, Inc.

TECHNICAL REVISIONS - The appearance of products, including safety agency certifications pictured on labels, may change depending on the date manufactured. Specifications are subject to change without notice.

## Looking for pricing, stock, or lifecycle information?

Click below to explore more details on WIN SOURCE:

- ⊖ [View SQ24T03150-PAA0 on WIN SOURCE](#)
- ⊖ [Bel Power Solutions Information](#)

## Optimize Your Supply Chain with WIN SOURCE Solutions

- ✓ Global Sourcing Solution
- ✓ Obsolete Management
- ✓ Cost Control Management
- ✓ Shortage Management
- ✓ Alternative Solution
- ✓ Excess Inventory Management