



**THE DATASHEET OF  
SP300V5.0-E116-0**



	<b>Datasheet</b>		TS	1085
	<b>Tire Pressure Monitoring Sensor SP30</b>		Rev.	5
			Page	1
			of	14



# Datasheet

## Tire Pressure Monitoring Sensor SP30

Revisions dates:

00	2003-01-03
1	2004-01-15
2	2005-11-25
3	2006-03-03
4	2008-08-29
5	2009-06-30

Document history: See end of document

	Date	Sign	Rev	Reference	Date	Dok	Stamp
Prepared	030131	AuR	00	Arkiv 49/03	030630	HKW	
Checked	030625	RH	3	EM 11148	060309		
Approved	030625	AuR	4	EM 12194			

# Table of contents

<b>1</b>	<b>PRODUCT DESCRIPTION</b> .....	<b>4</b>
1.1	Overview.....	4
1.2	Features .....	4
1.3	Ordering Information .....	4
<b>2</b>	<b>PRODUCT CHARACTERISTICS</b> .....	<b>5</b>
2.1	Measurement performance .....	5
2.1.1	<i>Pressure measurement</i> .....	5
2.1.2	<i>Acceleration measurement</i> .....	6
2.1.3	<i>Temperature measurement</i> .....	6
2.1.4	<i>Supply voltage measurement</i> .....	6
2.2	Current consumption .....	7
2.3	Tmax.....	7
2.4	Vmin .....	7
2.5	Clock sources.....	8
2.5.1	<i>System clock (MCLK)</i> .....	8
2.5.2	<i>Low Power (LP) oscillator</i> .....	8
2.5.3	<i>External clock</i> .....	8
2.6	LF input.....	8
2.7	Power-on reset .....	9
2.8	Digital I/O.....	9
<b>3</b>	<b>RECOMMENDED OPERATING CONDITIONS</b> .....	<b>9</b>
<b>4</b>	<b>ABSOLUTE MAXIMUM RATINGS</b> .....	<b>10</b>
<b>5</b>	<b>PHYSICAL DIMENSIONS AND MARKING</b> .....	<b>11</b>
5.1	Physical Dimensions .....	11
5.2	Marking.....	12
<b>6</b>	<b>PIN CONFIGURATION</b> .....	<b>13</b>
<b>7</b>	<b>DOCUMENT HISTORY</b> .....	<b>14</b>

	<h1>Datasheet</h1>	<b>TS</b> 1085 <b>Rev.</b> 5 <b>Page</b> 3 <b>of</b> 14
	<b>Tire Pressure Monitoring Sensor SP30</b>	

**Edition 2009-06-30**

**Published by**

**Infineon Technologies AG**

**Am Campeon 1-12**

**85579 Neubiberg, Germany**

**© Infineon Technologies AG 2006.**

**All Rights Reserved.**

The information given in this data sheet shall in no event be regarded as a guarantee of conditions or characteristics ("Beschaffheitsgarantie"). With respect to any examples or hints given herein, any typical values stated herein and/or any information regarding the application of the device, Infineon Technologies hereby disclaims any and all warranties and liabilities of any kind, including without limitation warranties of non-infringement of intellectual property rights of any third party.

### Information

For further information on technology, delivery terms and conditions and prices please contact your nearest Infineon Technologies Office ([www.infineon.com](http://www.infineon.com)).

### Warnings

Due to technical requirements components may contain dangerous substances. For information on the types in question please contact your nearest Infineon Technologies Office.

Infineon Technologies Components may only be used in life-support devices or systems with the express written approval of Infineon Technologies, if a failure of such components can reasonably be expected to cause the failure of that life-support device or system, or to affect the safety or effectiveness of that device or system. Life support devices or systems are intended to be implanted in the human body, or to support and/or maintain and sustain and/or protect human life. If they fail, it is reasonable to assume that the health of the user or other persons may be endangered.

	<h1>Datasheet</h1>	<b>TS</b> 1085 <b>Rev.</b> 5 <b>Page</b> 4 <b>of</b> 14
	<b>Tire Pressure Monitoring Sensor SP30</b>	

## 1 Product Description

### 1.1 Overview

The SP30 Tire Pressure Monitoring (TPM) Sensor represents Infineon's standard pressure range TPM sensor. The SP30 offers a high level of integration by including a microcontroller, signal conditioning and LF-input stage to meet market demands for flexible, customer specific solutions and overall system cost reduction.

The sensor design is based on Infineon's proprietary and patented solutions for high reliability measurements in harsh automotive environments. Its predictable and stable quality is proven in high volume applications.

The SP30 measures pressures up to 900kPa, temperature, supply voltage and acceleration (optional), and by integrating these functions with an ASIC in one package, Infineon has developed the ideal product for standard pressure TPM applications.

### 1.2 Features

- Integrated Sensors
  - Pressure
  - Acceleration (optional)
  - Temperature
  - Voltage
- Integrated Peripherals
  - Microcontroller
  - On board EEPROM
  - GPIOs
  - ADC for signal conditioning
  - 2x LF Receiver for triggering
- Measurement Ranges
  - Pressure Sensor 100 to 450 kPa / 100 to 900kPa
  - Temperature Sensor -40 to +125°C
  - Supply Voltage Sensor 2.1 to 3.6 V
  - Acceleration Sensor -12 to 115 g

### 1.3 Ordering Information

Product Name	Product Type	Ordering Code	Package
SP300V5.0-E106-0	100...450kPa	SP000435430	P-DSOSP-14-6
SP300V5.0-E116-0	100...900kPa	SP000477044	P-DSOSP-14-6
SP300V5.0-E206-0	100...450kPa, no acceleration sensor	SP000477042	P-DSOSP-14-6
SP300V5.0-E216-0	100...900kPa, no acceleration sensor	SP000477040	P-DSOSP-14-6

	<h1>Datasheet</h1>					TS	1085
	<h2>Tire Pressure Monitoring Sensor SP30</h2>					Rev.	5
						Page	5
						of	14

## 2 Product Characteristics

The max and min values are to be understood as + and -  $5\sigma$  values (Cpk = 1.67) unless otherwise specified.

### 2.1 Measurement performance

#### 2.1.1 Pressure measurement

The presented performance reflects the use of 11-bit measurement of pressure signal and 10-bit measurement of temperature.

##### 2.1.1.1 Standard pressure measurement range

Table 1 Pressure measurement specifications, 100-450kPa range

PARAMETER	SPECIFICATION				AMBIENT CONDITIONS		COMMENTS
	Min	Typ	Max	Unit	Temp [°C]	VDD [V]	
Pressure range	100		450	kPa	-40 to 125	2.1 to 3.6	
Measurement error	-7		7	kPa	0 to 50	2.1 to 3.6	
	-9		9	kPa	50 to 70	2.1 to 3.6	
	-17.5		17.5	kPa	-40 to 125	2.1 to 3.6	

##### 2.1.1.2 Optional pressure measurement ranges

Table 2 Pressure measurement specifications, 100-700kPa range

PARAMETER	SPECIFICATION				AMBIENT CONDITIONS		COMMENTS
	Min	Typ	Max	Unit	Temp [°C]	VDD [V]	
Pressure range	100		700	kPa	-40 to 125	2.1 to 3.6	
Measurement error	-11		11	kPa	0 to 50	2.1 to 3.6	
	-14		14	kPa	50 to 70	2.1 to 3.6	
	-28		28	kPa	-40 to 125	2.1 to 3.6	

Table 3 Pressure measurement specifications, 100-800kPa range

PARAMETER	SPECIFICATION				AMBIENT CONDITIONS		COMMENTS
	Min	Typ	Max	Unit	Temp [°C]	VDD [V]	
Pressure range	100		800	kPa	-40 to 125	2.1 to 3.6	
Measurement error	-12.5		12.5	kPa	0 to 50	2.1 to 3.6	
	-16		16	kPa	50 to 70	2.1 to 3.6	
	-19.5		19.5	kPa	-40 to 125	2.1 to 3.6	

Table 4 Pressure measurement specifications, 100-900kPa range

PARAMETER	SPECIFICATION				AMBIENT CONDITIONS		COMMENTS
	Min	Typ	Max	Unit	Temp [°C]	VDD [V]	
Pressure range	100		900	kPa	-40 to 125	2.1 to 3.6	
Measurement error	-14		14	kPa	0 to 50	2.1 to 3.6	
	-18		18	kPa	50 to 70	2.1 to 3.6	
	-35		35	kPa	-40 to 125	2.1 to 3.6	

	<b>Datasheet</b>					TS	1085
	<b>Tire Pressure Monitoring Sensor SP30</b>					Rev.	5
						Page	6
						of	14

### 2.1.2 Acceleration measurement

The presented performance reflects the use of 12-bit measurement of acceleration signal and 10-bit measurement for temperature.

Table 5 Acceleration measurement specifications

PARAMETER	SPECIFICATION				AMBIENT CONDITIONS		COMMENTS
	Min	Typ	Max	Unit	Temp [°C]	VDD [V]	
Input range	-12		115	g	-40 to 90	2.1 to 3.6	
Sensitivity accuracy	-18.75		18.75	%	-40 to 90	2.1 to 3.6	
Offset accuracy	-6		6	g	-20 to 70	2.1 to 3.6	
	-8.5		8.5	g	-40 to 90	2.1 to 3.6	

### 2.1.3 Temperature measurement

The presented performance reflects the use of 10-bit measurement of temperature.

Table 6 Temperature measurement specifications

PARAMETER	SPECIFICATION				AMBIENT CONDITIONS		COMMENTS
	Min	Typ	Max	Unit	Temp [°C]	VDD [V]	
Measurement error	-3		3	°C	-20 to 70	2.1 to 3.6	
	-5		5	°C	-40 to 90	2.1 to 3.6	
	-3		7	°C	90 to 125	2.1 to 3.6	

### 2.1.4 Supply voltage measurement

The presented performance reflects the use of 9-bit measurement of supply voltage.

Table 7 Supply voltage measurement specifications

PARAMETER	SPECIFICATION				AMBIENT CONDITIONS		COMMENTS
	Min	Typ	Max	Unit	TEMP [°C]	VDD [V]	
Measurement error	-100		+100	mV	-40 to 125	V <sub>THR</sub> to 3.6	

	<h1>Datasheet</h1>					TS	1085
	<h2>Tire Pressure Monitoring Sensor SP30</h2>					Rev.	5
						Page	7
						of	14

## 2.2 Current consumption

Table 8 Current consumption

PARAMETER	SPECIFICATION				AMBIENT CONDITIONS		COMMENTS
	Min	Typ	Max	Unit	Temp [°C]	VDD [V]	
Power down current		0.4	0.6	µA	25	3.0	
Power down current		13	20	µA	125	3.0	
IDLE current		30	50	µA	25	3.0	
IDLE current		50	75	µA	125	3.0	
RUN current		0.53	0.8	mA	25	3.0	
RUN current		0.65	1.0	mA	125	3.0	
Pressure measurement		4	12	µAs	-40 to 125	2.1 to 3.6	11 bit A/D conversion, excl. temperature meas
Acceleration measurement		6	16	µAs	-40 to 125	2.1 to 3.6	12 bit A/D conversion, excl. temperature meas
Temperature measurement		0.9	2.5	µAs	-40 to 125	2.1 to 3.6	10 bit A/D conversion
Supply voltage measurement		0.3	2.5	µAs	-40 to 125	2.1 to 3.6	9 bit A/D conversion
Peak current		1.6	2.5	mA	25	3.0	Pressure measurement and 1 LF channel on, duration is 1280µs for 11 bit measurement for the peak current only.
1 channel LF current		2.6	4.6	µA	25	3.0	
1 channel LF current		3.0	6.7	µA	125	3.0	
2 channel LF current		4.5	5.5	µA	25	3.0	2 <sup>nd</sup> LF channel is optional
2 channel LF current		6.5	11	µA	125	3.0	2 <sup>nd</sup> LF channel is optional
Thermal shutdown current		18	25	µA	125	3.0	
Thermal shutdown current		30	50	µA	150	3.0	

## 2.3 Tmax

$\vartheta_{\text{SHTD}}$  represents the temperature at which the Thermal Shut-down function can be enabled and  $\vartheta_{\text{REL}}$  represents the temperature at which the Master Reset state is released. The  $\vartheta_{\text{SHTD}}$  is always higher than  $\vartheta_{\text{REL}}$ .

Table 9 Trigger temperatures for thermal shutdown

PARAMETER	SPECIFICATION				AMBIENT CONDITIONS		COMMENTS
	Min	Typ	Max	Unit	TEMP [°C]	VDD [V]	
$\vartheta_{\text{SHTD}}$	102		123	°C	-40 to 175	2.1 to 3.6	Thermal shutdown enable
$\vartheta_{\text{REL}}$	100		121	°C	-40 to 175	2.1 to 3.6	Master Reset release

## 2.4 Vmin

The voltage at which the Vmin-circuit will return a low battery voltage status is specified in Table 10:

Table 10 Vmin specifications

PARAMETER	SPECIFICATION				AMBIENT CONDITIONS		COMMENTS
	Min	Typ	Max	Unit	TEMP [°C]	VDD [V]	
Vmin	2.0	2.1	2.2	V	-40 to 125	V <sub>THR</sub> to 3.6	

	<h1>Datasheet</h1>					TS	1085
	<h2>Tire Pressure Monitoring Sensor SP30</h2>					Rev.	5
						Page	8
						of	14

## 2.5 Clock sources

### 2.5.1 System clock (MCLK)

Table 11 System clock (MCLK) specifications

PARAMETER	SPECIFICATION				AMBIENT CONDITIONS		COMMENTS
	Min	Typ	Max	Unit	TEMP [°C]	VDD [V]	
MCLK frequency	1.8	2.0	2.2	MHz	-40 to 125	2.1 3.6	

### 2.5.2 Low Power (LP) oscillator

Table 12 LP oscillator specifications

PARAMETER	SPECIFICATION				AMBIENT CONDITIONS		COMMENTS
	Min	Typ	Max	Unit	TEMP [°C]	VDD [V]	
T <sub>it</sub>	0.5, 1.0, 2.0 or 4.0			s	-40 to 125	2.1 to 3.6	Interval timer main tick
del <sub>2t</sub>	25, 50, 75 or 100			ms	-40 to 125	2.1 to 3.6	Delay to extra tick
LP oscillator accuracy	-20		20	%	-40 to 125	2.1 to 3.6	

### 2.5.3 External clock

Table 13 External clock specifications

PARAMETER	SPECIFICATION				AMBIENT CONDITIONS		COMMENTS
	Min	Typ	Max	Unit	TEMP [°C]	VDD [V]	
External clock			3.5	MHz	-40 to 125	2.1 to 3.6	

## 2.6 LF input

Table 14 LF telegram

PARAMETER	SPECIFICATION				AMBIENT CONDITIONS		COMMENTS
	Min	Typ	Max	Unit	TEMP [°C]	VDD [V]	
Modulation		ASK			-40 to 125	2.1 to 3.6	
Carrier frequency	121.25	125	128.75	kHz	-40 to 125	2.1 to 3.6	
Preamble period	4			ms	-40 to 125	2.1 to 3.6	
Data rate	3.84	3.9	3.96	kHz	-40 to 125	2.1 to 3.6	
Settling time			2	ms	-40 to 125	2.1 to 3.6	Time from LF interface is turned on by RISC to the LF interface is active
Detection threshold			5	mVp-p	-40 to 125	2.1 to 3.6	
Input capacitance		10	12	pF	-40 to 125	2.1 to 3.6	
Input resistance	500			kΩ	-40 to 125	2.1 to 3.6	
Other	The input signals from the enabled LF channels are rectified and real time summed						

	<b>Datasheet</b>					TS	1085
	<b>Tire Pressure Monitoring Sensor SP30</b>					Rev.	5
						Page	9
						of	14

Table 15 LF Carrier Detection

PARAMETER	SPECIFICATION				AMBIENT CONDITIONS		COMMENTS
	Min	Typ	Max	Unit	TEMP [°C]	VDD [V]	
Carrier frequency	121.25	125	128.75	kHz	-40 to 125	2.1 to 3.6	
Maximum sensitivity not to detect, 2 amplifiers enabled	4			mVp-p	0 to 90	2.1 to 3.6	
	3.5			mVp-p	90 to 125	2.1 to 3.6	
	3.5			mVp-p	-40 to 0	2.1 to 3.0	
	2.9			mVp-p	-40 to 0	3.0 to 3.6	
Minimum sensitivity to detect, 2 amplifiers enabled	10			mVp-p	0 to 90	2.1 to 3.6	
	12.2			mVp-p	90 to 125	2.1 to 3.6	
	12.2			mVp-p	-40 to 0	2.1 to 3.6	
Maximum sensitivity not to detect, 3 amplifiers enabled		0.8		mVp-p	-40	3.6	Guaranteed by ASIC characterization
	0.25			mVp-p	-40	2.1 to 3.0	
	0.25			mVp-p	0 to 125	2.1 to 3.6	
Minimum sensitivity to detect, 3 amplifiers enabled			2.5	mVp-p	-40 to 125	2.1 to 3.6	Guaranteed by ASIC characterization

## 2.7 Power-on reset

Table 16 Power-on reset level

PARAMETER	SPECIFICATION				COMMENTS
	Min	Typ	Max	Unit	
Power-on reset level, $V_{THR}$	1.8	1.85	1.9	V	

## 2.8 Digital I/O

Table 17 Digital I/O specifications

PARAMETER	SPECIFICATION				COMMENTS
	Min	Typ	Max	Unit	
Digital output high	$V_{DD}-0.3$			V	At 1 mA load current
Digital output low			0.3	V	At 1 mA load current
Digital input high	$0.8 \cdot V_{DD}$			V	
Digital input low			$0.2 \cdot V_{DD}$	V	
Input current			$\pm 1$	$\mu A$	

## 3 Recommended Operating Conditions

Table 18 Recommended operating conditions

PARAMETER	SPECIFICATION				COMMENTS
	Min	Typ	Max	Unit	
Supply voltage	$V_{THR}$		3.6	V	Unless otherwise specified
Ambient temperature	-40		125	°C	

	<b>Datasheet</b>				TS	1085
	<b>Tire Pressure Monitoring Sensor SP30</b>				Rev.	5
					Page	10
					of	14

## 4 Absolute Maximum Ratings

Table 19 Absolute maximum ratings

PARAMETER	SPECIFICATION				COMMENTS
	Min	Typ	Max	Unit	
Ambient temperature, operating	-40		150	°C	Max 24 hrs accumulated over life time
Ambient temperature, storage	-40		150	°C	Max 1000 hours
Transient temperature <sup>1</sup>			175	°C	Max 3 min
Supply Voltage	-0.3		4.0	V	
Input voltage	-0.3		V <sub>dd</sub> +0.3	V	
Input current, any pin (DC)	-10		10	mA	
Input current, any pin (transient)	-100		100	mA	
Input current, LF pins	-1		1	mA	
Maximum input pressure	1400			kPa	
Burst pressure	2000			kPa	
Static acceleration			2000	g	
Mechanical shock			4000	g	Half sine, 0.3ms
ESD	2			kV	Human body model AEC-Q100
	200			V	Machine model AEC-Q100
Latch Up	100			mA	AEC-Q100

**Attention:** *Stress beyond the absolute maximum ratings may cause permanent damage to the device. Exposure to absolute maximum rating conditions for extended periods may affect device reliability. Maximum ratings are absolute ratings; exceeding only one of these values may cause irreversible damage to the device.*

<sup>1</sup> Will withstand standard reflow soldering process (JEDEC JESD22-B102-C)

	<h1>Datasheet</h1>	<b>TS</b> 1085 <b>Rev.</b> 5 <b>Page</b> 11 <b>of</b> 14
	<b>Tire Pressure Monitoring Sensor SP30</b>	

## 5 Physical Dimensions and Marking

### 5.1 Physical Dimensions

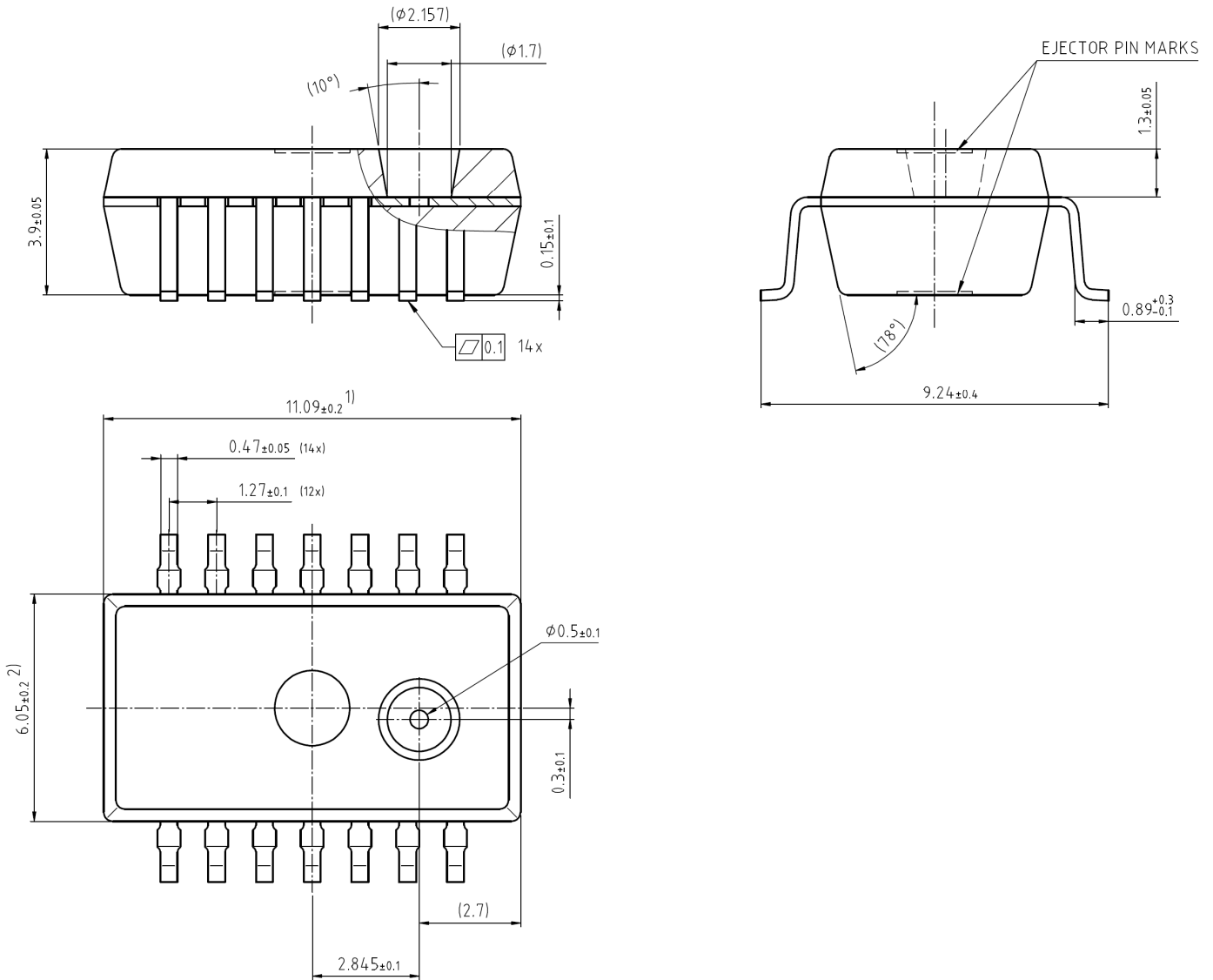

**Figure 1: Physical Dimensions – Drawing P-DSOSP-14-6** 1) Dimension does not include mold flash, protrusions or gate burrs. Mold flash, protrusions and gate burrs do not exceed 0.15mm (0.006 inch) per side. 2) Dimension does not include inter-lead flash or protrusions. Inter-lead flash and protrusions do not exceed 0.25mm (0.010 inch) per side.

	<h1>Datasheet</h1>	<b>TS</b> 1085 <b>Rev.</b> 5
	<b>Tire Pressure Monitoring Sensor SP30</b>	<b>Page</b> 12 <b>of</b> 14

## 5.2 Marking

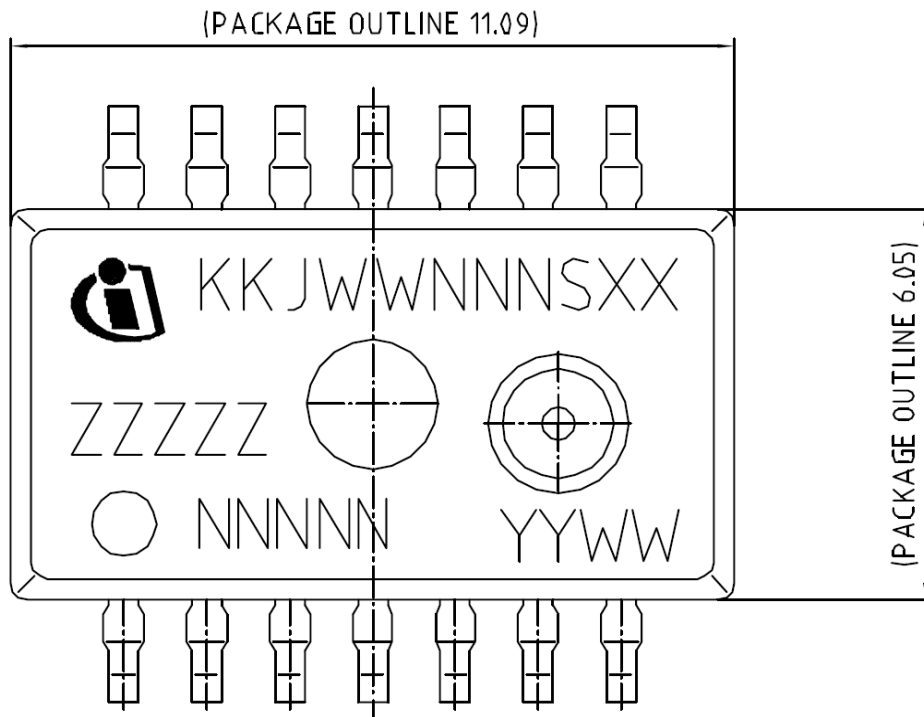

**Figure 2 Marking of the SP30**

The variables in **Figure 2** have the following meaning:

- |              |                                  |
|--------------|----------------------------------|
| KKJWWNNNSXX: | Infineon Lot Number              |
| YYWW:        | Date Code (YY = Year, WW = week) |
| ZZZZZ:       | Product                          |
| NNNNN:       | Optional Marking                 |
| O:           | Pin 1 Marking                    |

	<h1>Datasheet</h1>	<b>TS</b> 1085 <b>Rev.</b> 5 <b>Page</b> 13 <b>of</b> 14
	<b>Tire Pressure Monitoring Sensor SP30</b>	

## 6 Pin Configuration

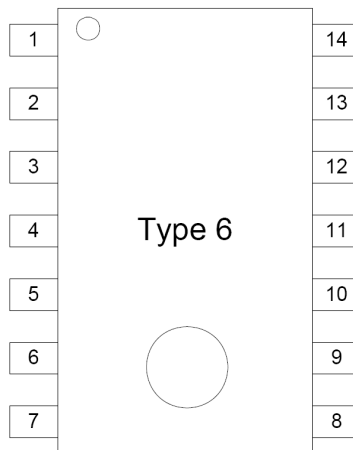

**Figure 3: Pin Configuration. Top view, not to scale**

*Table 20 Pin Description*

PIN	NAME	FUNCTION
1	IN4	LF receiver channel 2, negative input
2	P10	General purpose I/O with external wakeup, internal pull-up/pull-down
3	P11	General purpose I/O with external wakeup, internal pull-up/pull-down
4	MSDA	Monitor Serial Data I/O, internal pull-up
5	MSCl	Monitor Serial Clock input
6	VDD	Supply pad VDD (battery, positive terminal)
7	VSS	Common ground (battery, negative terminal)
8	VSS	Common ground (battery, negative terminal)
9	P17	General purpose I/O (or digital modulator output)
10	P15	General purpose I/O or external clock
11	P14	General purpose I/O (or digital modulator output)
12	IN1	LF receiver channel 1, positive input
13	IN2	LF receiver channel 1, negative input
14	IN3	LF receiver channel 2, positive input

	<h1>Datasheet</h1>	<b>TS</b> 1085 <b>Rev.</b> 5 <b>Page</b> 14 <b>of</b> 14
	<b>Tire Pressure Monitoring Sensor SP30</b>	

## 7 Document history

Rev	Paragraphs	Description
00		First issue of TS1085 (identical to TS0212P rev C)
1	1.1.1.2	Added objective specification for 1400 kPa sensor
1	1.1.3	Temperature accuracy above +90 °C improved to -3 °C
1	1.2	Temperature measurement max value 2.5 μAs
1	1.2	Supply voltage measurement max value 2.5 μAs
1	1.2	Added peak current measurement
1	1.2	1 channel LF current, 25 °C, max value 4.6 μA
1	1.2	1 channel LF current, 125 °C, max value 6.7μA
1	1.6	LF input capacitance max value included
1	1.6	LF input resistor min value included, typical value removed, comment removed
1	3	Ambient temperature, storage, max 1000 hrs
1	3	Input currents specified
1	3	Maximum input pressure and burst pressure values listed in minimum column
2	1.1.1	(All tables) Added specification point between 50 and 70 °C to meet ISO standard
2	1.1.1	Added specification for 800 kPa
2	4.1	Updated reference to physical dimensions and marking
3	1.1.1	Improved specification for 800 kPa, outer temperatures
3	1.6	LF CD updated
3	1.8	Output high/low values corrected (min/max swapped)
4		Removed "Confidential" Marking
4		Added Disclaimer
4	1	Added Section "Product Description"
4	5	Added Section "Physical Dimension and Marking"
4	6	Added Section "Pin Configuration"
4	4	Added note to maximum ratings
4	2.1.1.2	Removed 1400kPa option
5	5.2	Updated marking

## Looking for pricing, stock, or lifecycle information?

Click below to explore more details on WIN SOURCE:

- ⊖ [View SP300V5.0-E116-0 on WIN SOURCE](#)
- ⊖ [Infineon Technologies Information](#)

## Optimize Your Supply Chain with WIN SOURCE Solutions

- ✓ Global Sourcing Solution
- ✓ Obsolete Management
- ✓ Cost Control Management
- ✓ Shortage Management
- ✓ Alternative Solution
- ✓ Excess Inventory Management