



**THE DATASHEET OF
SN761677DA**



TV/VCR TUNER IC WITH DC/DC CONVERTER

FEATURES

- Single Chip Mixer/Oscillator, Synthesizer, and 30-V DC/DC Converter for Tuning Amplifier
- VHF-L, VHF-H, UHF 3-Band Local Oscillator
- I²C Bus Protocol
- Four Data Bytes Transmission
- Low Noise DC/DC Converter
- 4ch NPN Emitter Follower Type Band Switch Drivers
- 4ch NPN Open Collector Type Ports
- Programmable Reference Divider Ratio (31.25 kHz, 50 kHz, or 62 kHz)
- 5-V Power Supply
- 38-Pin TSSOP Package

DESCRIPTION

The SN761677 is a single-chip synthesized tuner IC designed for TV/VCR tuning systems. The circuit consists of a PLL synthesizer, 3-band local oscillators and mixer, 30-V dc/dc converter for tuning the amplifier, four NPN emitter follower band drivers, four NPN open collector ports, and is available in a small package outline. The 15-bit programmable counter and reference divider are controlled by I²C bus control. Tuning step frequency is selectable by the reference divider ratio for a 4-MHz Xtal oscillator.

DA PACKAGE (TOP VIEW)
38-PIN TSSOP (DA)

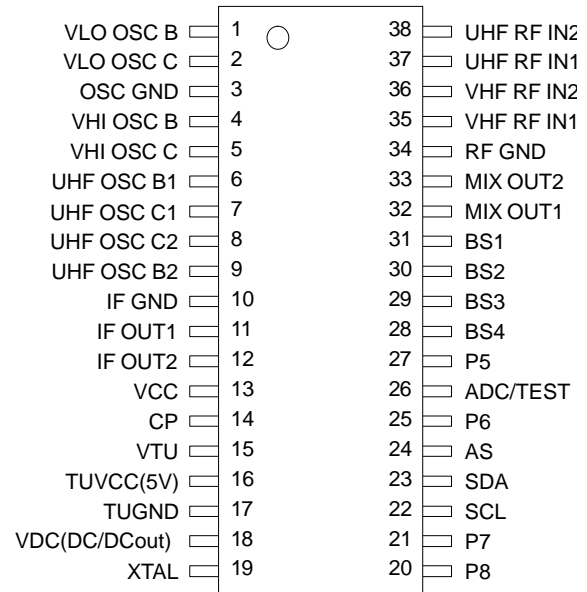

Please be aware that an important notice concerning availability, standard warranty, and use in critical applications of Texas Instruments semiconductor products and disclaimers thereto appears at the end of this data sheet.



These devices have limited built-in ESD protection. The leads should be shorted together or the device placed in conductive foam during storage or handling to prevent electrostatic damage to the MOS gates.

ABSOLUTE MAXIMUM RATINGS

over operating free-air temperature range unless otherwise noted⁽¹⁾

		UNIT
Supply voltage ⁽²⁾ , V_{CC}	VCC, TUVCC	-0.4 V to 7 V
Input voltage 1 ⁽²⁾ , V_{GND}	RF GND, OSC GND, TUGND	-0.4 V to 0.4 V
Input voltage 2 ⁽²⁾ , V_{VTU}	VTU ⁽⁴⁾	-0.4 V to 35 V
Input voltage 3 ⁽²⁾ , V_{IN}	Other input pins	-0.4 V to 7 V
Continuous total dissipation ⁽³⁾ , P_D	$T_A \leq 25^\circ\text{C}$	1168 mW
Operating free-air temperature, T_A		-20°C to 85°C
Storage temperature range, T_{stg}		-65°C to 150°C
Maximum junction temperature, T_J		150°C
Maximum lead temperature 1,6 mm (1/16 inch) from case for 10 seconds		260°C
Maximum short circuit time, $t_{SC(max)}$	All pins to VCC/TUVCC, IFGND, OSCGND, RFGND, TUGND	10 sec

(1) Stresses beyond those listed under "absolute maximum ratings" may cause permanent damage to the device. These are stress ratings only, and functional operation of the device at these or any other conditions beyond those indicated under "recommended operating conditions" is not implied. Exposure to absolute-maximum-rated conditions for extended periods may affect device reliability.

(2) Voltage values are with respect to the IF GND of the circuit.

(3) Derating factor is 9.34 mW/°C for $T_A \leq 25^\circ\text{C}$.

(4) 30 V max, when input from external power supply.

RECOMMENDED OPERATING CONDITIONS

		MIN	NOM	MAX	UNIT
Supply voltage, V_{CC}		4.5	5	5.5	V
Band switch driver source current, I_{BS}	One port on			10	mA
NPN port sink current, I_{NPN}	One port on		-10	-15	mA
Operating free-air temperature, T_A		-20		85	°C

CAUTION:

It is advised that precautions be taken to avoid damage due to high static voltages or electrostatic fields while handling this device. UHF OSC (pins 6–9) can withstand 1.5 kV and all other pins can withstand 2 kV, according to the Human Body Model (1.5 k Ω , 100 pF).

ELECTRICAL CHARACTERISTICS
 $V_{CC} = 4.5\text{ V to }5.5\text{ V}$, $T_A = -20^\circ\text{C to }85^\circ\text{C}$ (unless otherwise noted)⁽¹⁾

PARAMETER		TEST CONDITIONS	MIN	TYP	MAX	UNIT
Total Device and Serial Interface						
I_{CC1}	Supply current 1 (VCC)			75	95	mA
I_{CC2}	Supply current 2 (VCC)	One band switch on ($I_{BS} = 10\text{ mA}$)		85	105	mA
I_{CC3}	Supply current 3 (TUVCC)	$I_{VDC} = 50\text{ }\mu\text{A}$		4	10	mA
V_{IH}	High-level input voltage (SCL, SDA)		3			V
V_{IL}	Low-level input voltage (SCL, SDA)				1.5	V
I_{IH}	High-level input current (SCL, SDA)				10	μA
I_{IL}	Low-level input current (SCL, SDA)		-10			μA
V_{POR}	Power-on reset supply voltage	Threshold of supply voltage between reset and operation mode	2.1	3.7	4	V
DC/DC Converter						
$V_{O(VDC)}$	Output voltage (VDC)	$I_{VDC} = 50\text{ }\mu\text{A}$		35		V
$I_{C(VDCM)}$	Output current (VDC)			230		μA
t_s	Output settling time (VDC)	From $V_{TUVCC} > 4.5\text{ V}$ to $V_{O(VDC)} < 28\text{ V}$		100		ms
I²C Interface						
V_{ASH}	Address select high-input voltage (AS)	$V_{CC} = 5\text{ V}$	4.5		5	V
V_{ASM}	Address select mid-input voltage (AS)	$V_{CC} = 5\text{ V}$	2		3	V
V_{ASL}	Address select low-input voltage (AS)	$V_{CC} = 5\text{ V}$			0.5	V
I_{ASH}	Address select high-input current (AS)				10	μA
I_{ASL}	Address select low-input current (AS)		-10			μA
$V_{I(ADC)}$	ADC input voltage	See Table 9	0		V_{CC}	V
$I_{IH(ADH)}$	ADC high-level input current	$V_{I(ADC)} = V_{CC}$			10	μA
$I_{IL(ADL)}$	ADC low-level input current	$V_{I(ADC)} = 0\text{ V}$	-10			μA
V_{OL}	Low-level output voltage (SDA)	$V_{CC} = 5\text{ V}$, $I_{OL} = 3\text{ mA}$			0.4	V
$I_{lkg(SDA)}$	High-level output leakage current (SDA)	$V_{SDA} = 5.5\text{ V}$			10	μA
F_{SCL}	Clock frequency (SCL)			100	400	kHz
$t_h(\text{DAT})$	Data hold time	See timing chart in Figure 1	0			μs
t_{BUF}	Bus free time		1.3			μs
$t_h(\text{STA})$	Start hold time		0.6			μs
$t_h(\text{low})$	SCL low hold time		0.6			μs
$t_h(\text{high})$	SCL high hold time		0.6			μs
$t_{su}(\text{STA})$	Start setup time		0.6			μs
$t_{su}(\text{DAT})$	Data setup time		0.1			μs
t_r	SCL, SDA rise time				0.3	μs
t_f	SCL, SDA fall time				0.3	μs
$t_{su}(\text{STO})$	STOP setup time		0.6			μs

ELECTRICAL CHARACTERISTICS (Continued)
 $V_{CC} = 4.5\text{ V to }5.5\text{ V}$, $T_A = -20^\circ\text{C to }85^\circ\text{C}$ (unless otherwise noted)⁽¹⁾

PARAMETER		TEST CONDITIONS	MIN	TYP	MAX	UNIT
PLL and NPN Port						
N	Divider ratio	14-bit frequent word	256		16383	
		15-bit frequent word	256		32767	
FXTAL	Crystal oscillator	Rxtal = 25 Ω to 300 Ω		4		MHz
ZXTAL	Crystal oscillator input impedance	$V_{CC} = 5\text{ V}$, $T_A = 25^\circ\text{C}$		2.3		k Ω
VXTALIN	External crystal oscillator input amplitude		400			mV _{p-p}
V _{O(TU)}	Tuning amplifier low-level output voltage	$R_L = 27\text{ k}\Omega$		0.4	0.7	V
I _{IH(CPH)}	Charge pump high-level input current	CP = 1		40		μA
I _{IL(CPH)}	Charge pump low-level input current	CP = 0		10		μA
V _{O(CP)}	Charge pump output voltage	In lock		1.95		V
I _{Ikg(CPOFF)}	Charge pump leakage current	T2 = 0, T1 = 1, V _{O(CP)} = 2 V, T _A = 25°C	-15		15	nA
I _{BS}	Band switch driver source current				10	mA
V _{O(SBS1)}	Band switch driver output voltage	I _{BS} = 10 mA	3			V
V _{O(SBS2)}		I _{BS} = 10 mA, V _{CC} = 5 V, T _A = 25°C	3.5	3.9		V
I _{Ikg(BSOFF)}	Band switch driver leakage current	V _{BS} = 0 V			3	μA
I _{NPN}	NPN port sink current				-15	mA
V _{O(SN1)}	NPN port output voltage	I _{NPN} = 100 μA			0.2	V
V _{O(SN2)}		I _{NPN} = 10 mA			0.5	V
I _{Ikg(NPNOFF)}	NPN port leakage current	V _{CC} = 5.5 V, V _{NPN} = 1.5 V			1	μA

ELECTRICAL CHARACTERISTICS
 $V_{CC} = 5\text{ V}$, $T_A = -25^\circ\text{C}$, measured in reference measurement circuit at 50- Ω system, IF filter characteristics: $f_{\text{peak}} = 43\text{ MHz}$; (unless otherwise noted)⁽¹⁾

PARAMETER		CONDITION	MIN	TYP	MAX	UNIT
MIXER, OSCILLATOR, IF AMPLIFIER						
G_{c1}	Conversion gain (mixer-IF amplifier) VHF low	$F_{in} = 58\text{ MHz}^{(1)}$	23	26	29	dB
G_{c3}		$F_{in} = 130\text{ MHz}$				
G_{c4}	Conversion gain (mixer-IF amplifier) VHF high	$F_{in} = 136\text{ MHz}^{(1)}$	23	26	29	dB
G_{c6}		$F_{in} = 364\text{ MHz}$				
G_{c7}	Conversion gain (mixer-IF amplifier) VHF-UHF	$F_{in} = 370\text{ MHz}^{(1)}$	24	27	30	dB
G_{c9}		$F_{in} = 804\text{ MHz}$				
NF_1	Noise figure VHF low	$F_{in} = 55.25\text{ MHz}$		11		dB
NF_3		$F_{in} = 127.25\text{ MHz}$				
NF_4	Noise figure VHF high	$F_{in} = 133.25\text{ MHz}$		11		dB
NF_6		$F_{in} = 361.25\text{ MHz}$				
NF_7	Noise figure UHF	$F_{in} = 367.25\text{ MHz}$		10		dB
NF_9		$F_{in} = 801.25\text{ MHz}$				
CM_1	1% cross modulation distortion VHF low	$F_{in} = 55.25\text{ MHz}^{(2)}$		89		dB μ V
CM_3		$F_{in} = 127.25\text{ MHz}$				
CM_4	1% cross modulation distortion VHF high	$F_{in} = 133.25\text{ MHz}^{(2)}$		86		dB μ V
CM_6		$F_{in} = 361.25\text{ MHz}$				
CM_7	1% cross modulation distortion UHF	$F_{in} = 367.25\text{ MHz}^{(2)}$		87		dB μ V
CM_9		$F_{in} = 801.25\text{ MHz}$				
$V_{O(IF1)}$	IF output voltage VHF low	$F_{in} = 55.25\text{ MHz}^{(3)}$		117		dB μ V
$V_{O(IF3)}$		$F_{in} = 127.25\text{ MHz}$				
$V_{O(IF4)}$	IF output voltage VHF high	$F_{in} = 133.25\text{ MHz}^{(3)}$		117		dB μ V
$V_{O(IF6)}$		$F_{in} = 361.25\text{ MHz}$				
$V_{O(IF7)}$	IF output voltage UHF	$F_{in} = 367.25\text{ MHz}^{(3)}$		117		dB μ V
$V_{O(IF9)}$		$F_{in} = 801.25\text{ MHz}$				

⁽¹⁾ IF = 43 MHz, RF input level = 80 dB μ V

⁽²⁾ $F_{undes} = F_{des} \pm 6\text{ MHz}$, $p_{in} = 80\text{ dB}\mu\text{V}$, AM 1 kHz, 30%, DES/CM = S/I = 46 dB

⁽³⁾ IF = 45.75 MHz_{top}

BLOCK DIAGRAM

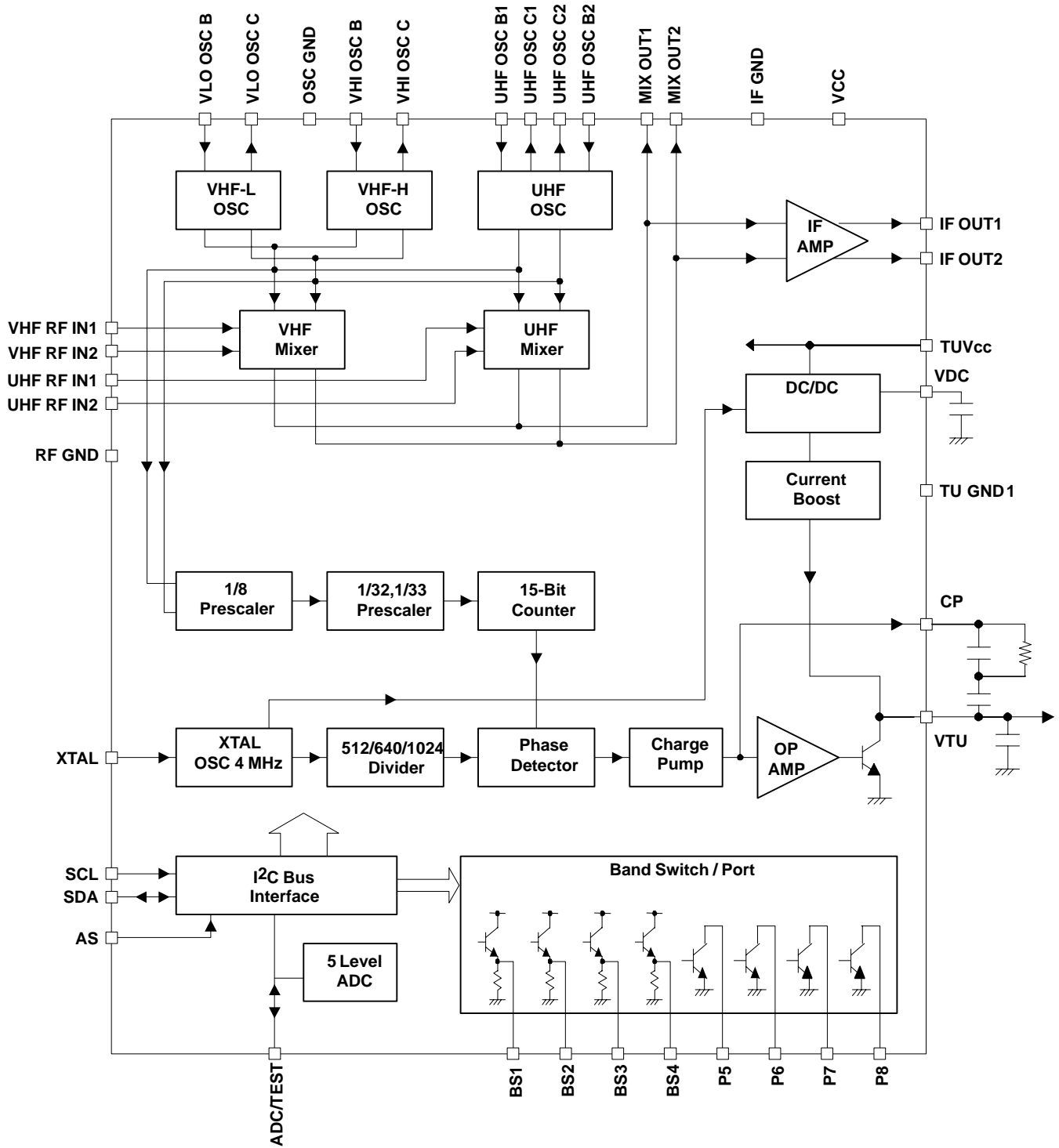

Terminal Functions

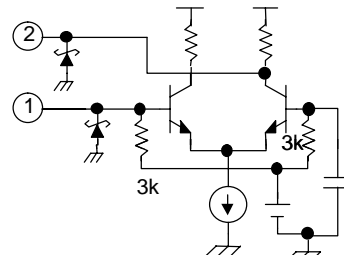
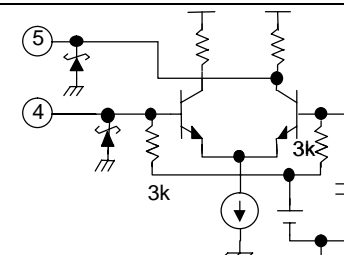
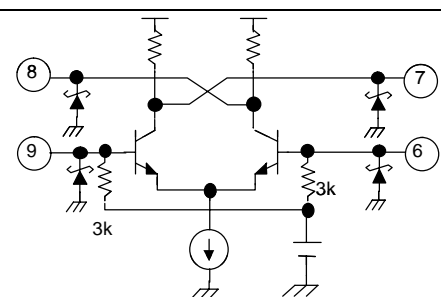
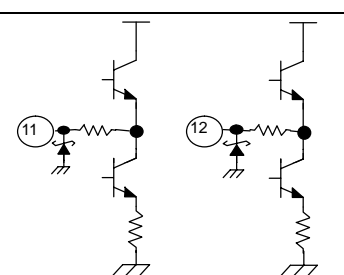
TERMINAL		DESCRIPTION	
NAME	NO.		
VLO OSC B	1	VHF low oscillator input base	
VLO OSC C	2	VHF low oscillator output collector	
OSC GND	3	Oscillator ground	
VHI OSC B	4	VHF hi oscillator input base	
VHI OSC C	5	VHF hi oscillator output collector	
UHF OSC B1	6	UHF oscillator input base1	
UHF OSC C1	7	UHF oscillator output collector1	
UHF OSC C2	8	UHF oscillator output collector2	
UHF OSC B2	9	UHF oscillator input base2	
IF GND	10	IF ground	
IF OUT1	11	IF output	
IF OUT2	12	IF output	
VCC	13	Supply voltage for mixer/oscillator/PLL: 5 V	

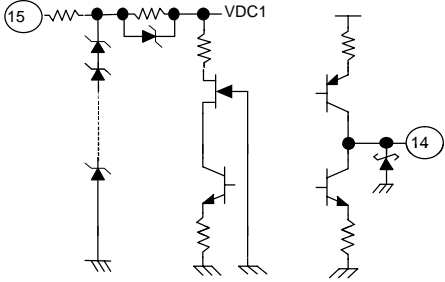
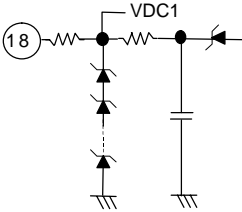
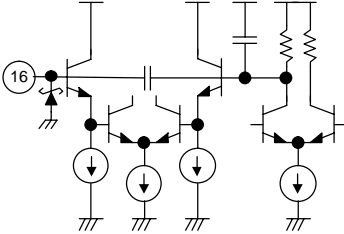
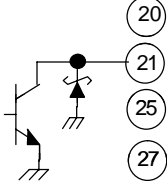
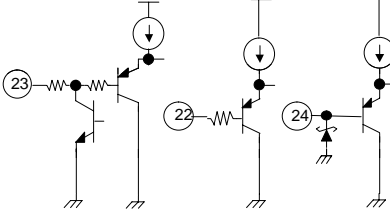
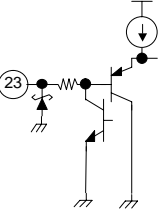
TERMINAL		DESCRIPTION	
NAME	NO.		
CP	14	Charge pump output	
VTU	15	Tuning voltage amplifier output	
TUVCC	16	Supply voltage for DC/DC converter: 5 V	
TUGND	17	DC/DC converter ground	
VDC	18	DC/DC converter monitor output. (Do not connect to other terminals or circuits except for the capacitor.)	
XTAL	19	4-MHz crystal oscillator input	
P8	20	Port 8 output (NPN open collector)	
P7	21	Port 7 output (NPN open collector)	
P6	25	Port 6 output (NPN open collector)	
P5	27	Port 5 output (NPN open collector)	
SCL	22	I ² C serial clock input	
SDA	23	I ² C serial data input/output	
AS	24	I ² C address set input	
ADC/TEST	26	ADC input / test output	

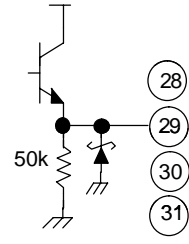
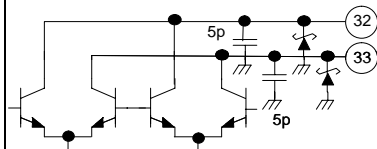
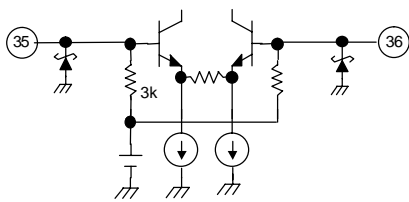
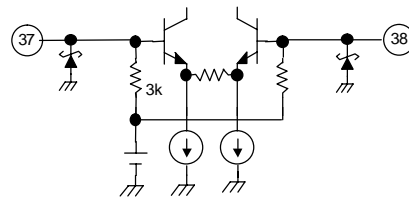
TERMINAL		DESCRIPTION	
NAME	NO.		
BS4	28	Band switch4 output (NPN emitter follower)	
BS3	29	Band switch3 output (NPN emitter follower)	
BS2	30	Band switch2 output (NPN emitter follower)	
BS1	31	Band switch1 output (NPN emitter follower)	
MIX OUT1	32	Mixer output	
MIX OUT2	33	Mixer output	
RF GND	34	RF ground	
VHF RF IN1	35	VHF RF input	
VHF RF IN2	36	VHF RF input	
UHF RF IN1	37	UHF RF input	
UHF RF IN2	38	UHF RF input	

FUNCTION DESCRIPTION

The device can be controlled according to the I²C bus format.

Table 1. Serial Interface Function

PIN	PIN NAME	DESCRIPTION
22	SCL	Clock input
23	SDA	Data input/output
24	AS	Address selection input
26	ADC/TEST	ADC input, test output

I²C Write Mode (R/W = 0)

Table 2. Write Data Format

	MSB							LSB	
Address byte (ADB)	1	1	0	0	0	MA1	MA0	R/W=0	A
Divider byte 1 (DB1)	0	N14	N13	N12	N11	N10	N9	N8	A
Divider byte 2 (DB2)	N7	N6	N5	N4	N3	N2	N1	N0	A
Control byte (CB)	1	CP	T2	T1	T0	RSA	RSB	OS	A
Ports byte (PB)	P8	P7	P6	P5	BS4	BS3	BS2	BS1	A

Table 3. Description of Data Symbol

SYMBOL	DESCRIPTION	DEFAULT																
MA1, MA0	Address set bits (See Table 4)																	
N14...N0	Programmable counter set bits N=N14x2 ¹⁴ +N13x2 ¹³ +...+N1x2+N0	Nn=0																
CP	Charge pump current set bit 10 μA (CP=0) 40 μA (CP=1)	CP=1																
T2, T1, T0	Test bits (See Table 5) Normal mode: T2=0, T1=0, T0=1/0	T2=0, T1=0, T0=0																
RSA, RSB	Reference divider ratio selection bits (See Table 6)	RSA=0, RSB=1																
OS	Tuning amplifier control bit Tuning voltage ON (OS=0) Tuning voltage OFF, high impedance (OS=1)	OS=0																
BS4...BS1	Band switch ports control bits BSn=0:Tr=OFF BSn=1:Tr=ON Band selection by BS1, 2, 4 (x: don't care) <table style="margin-left: 40px;"> <thead> <tr> <th></th> <th>BS1</th> <th>BS2</th> <th>BS4</th> </tr> </thead> <tbody> <tr> <td>VHF–Lo</td> <td>1</td> <td>0</td> <td>0</td> </tr> <tr> <td>VHF–Hi</td> <td>x</td> <td>1</td> <td>0</td> </tr> <tr> <td>UHF</td> <td>x</td> <td>x</td> <td>1</td> </tr> </tbody> </table>		BS1	BS2	BS4	VHF–Lo	1	0	0	VHF–Hi	x	1	0	UHF	x	x	1	BSn=0
	BS1	BS2	BS4															
VHF–Lo	1	0	0															
VHF–Hi	x	1	0															
UHF	x	x	1															
P8...P5	NPN open collector ports control bits Pn=0: Tr=OFF Pn=1: Tr=ON	Pn=0																
X	Don't care																	

NOTE: A: Acknowledge

Table 4. Address Selection

VOLTAGE APPLIED ON AS INPUT	MA1	MA0
0 V to 0.1 V _{CC}	0	0
Always valid	0	1
0.4 V _{CC} to 0.6 V _{CC}	1	0
0.9 V _{CC} to V _{CC}	1	1

Table 5. Test Bits

T2	T1	T0	FUNCTION	
0	0	0	Normal operation	Default
0	0	1	Normal operation	
0	1	X	Charge pump off	
1	1	0	Charge pump sink	
1	1	1	Charge pump source	
1	0	X	Test mode	Not available ADC

Table 6. Ratio Select Bits

RSA	RSB	REFERENCE DIVIDER RATIO
X	0	640
0	1	1024
1	1	512

I²C Read Mode (R/W = 1)

Table 7. Read Data Format

	MSB							LSB	
Address byte (ADB)	1	1	0	0	0	MA1	MA0	R/W=1	A
Status byte (SB)	POR	FL	1	1	1	A2	A1	A0	A

NOTE: A: Acknowledge

Table 8. Description of Data Symbol

SYMBOL	DESCRIPTION	DEFAULT
MA1, MA0	Address set bits (see Table 4)	
POR	Power-on reset flag POR Set: Power on POR Reset: End-of-data transmission procedure	POR=1
FL	In-lock flag PLL lock (FL=1) Unlock (FL=0)	
A2...A0	Digital data of ADC (see Table 9)	

Table 9. ADC Level

VOLTAGE APPLIED ON ADC INPUT	A2	A1	A0
0.6 V _{CC} to V _{CC}	1	0	0
0.45 V _{CC} to 0.6 V _{CC}	0	1	1
0.3 V _{CC} to 0.45 V _{CC}	0	1	0
0.15 V _{CC} to 0.3 V _{CC}	0	0	1
0 V _{CC} to 0.15 V _{CC}	0	0	0

(1) Accuracy is 0.03 x V_{CC}.

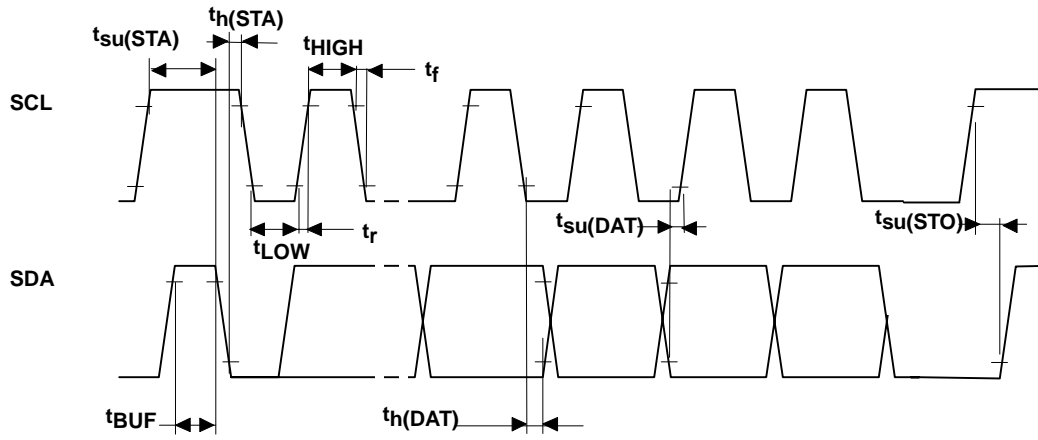

Figure 1. I²C Timing Chart

COMPONENT VALUES FOR MEASUREMENT CIRCUIT (TENTATIVE)

PART NAME	VALUE
C1, C2, C4	1 pF
C3	47 pF
C5	1.5 pF
C6	56 pF
C7–C10	1 pF (axial ceramic)
C11	100 pF
C12	13 pF (axial ceramic)
C13, C14, C16, C17, C19–C21, C34–C39, C64, C101	2.2 nF
C18, C23	0.047 μ F
C24	68 pF
C33	18 pF
C41, C60, C62, C201	Not mounted
C50	3 pF
R1, R2, R4, R5, R8	33 k Ω
R7	100 k Ω
R10, R21, R101, R201	0 Ω
R16–R19	330 Ω
R30	20 Ω
R31	50 Ω
L1	2.6 ϕ , 8T, wire 0,3 mm
L2	2.4 ϕ , 4T, wire 0,4 mm
L3	2.8 ϕ , 2T, wire 0,4 mm
L4	2.1 ϕ , 3T, wire 0,4 mm
L9, L10	2.5 ϕ , 16T, wire 0,25 mm
VC1, VC2, VC3	1T363A
X1	4 MHz

TEST CIRCUIT

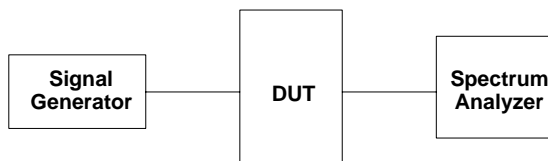

Figure 3. Measurement Circuit of Conversion Gain

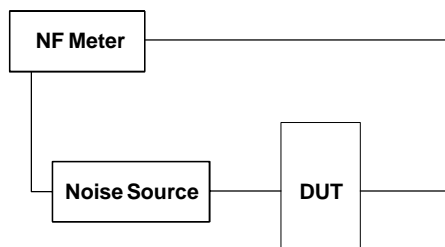

Figure 4. Noise Figure Measurement Circuit

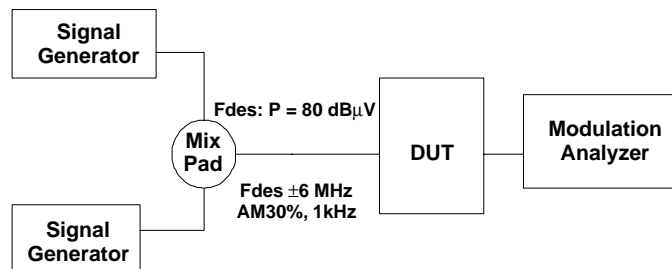

Figure 5. 1% Cross Modulation Distortion Measurement Circuit

S-PARAMETER

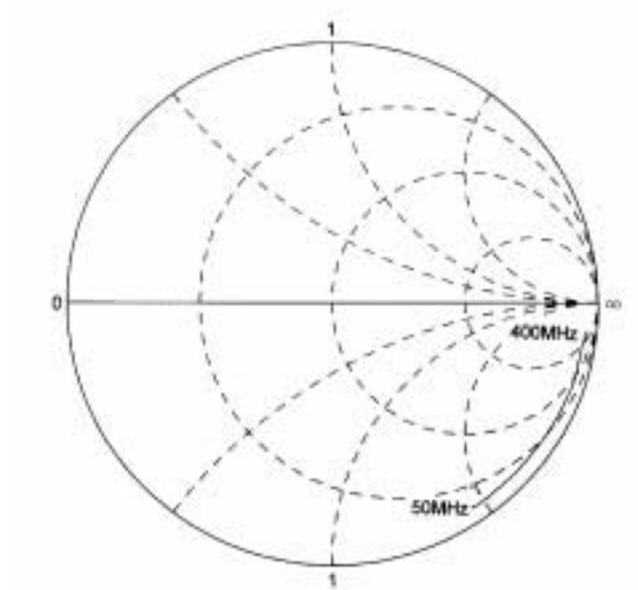

Figure 6. VHF Input

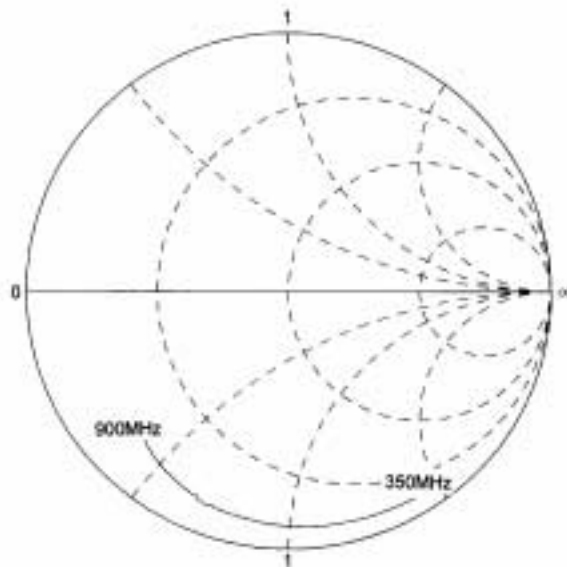

Figure 7. UHF Input

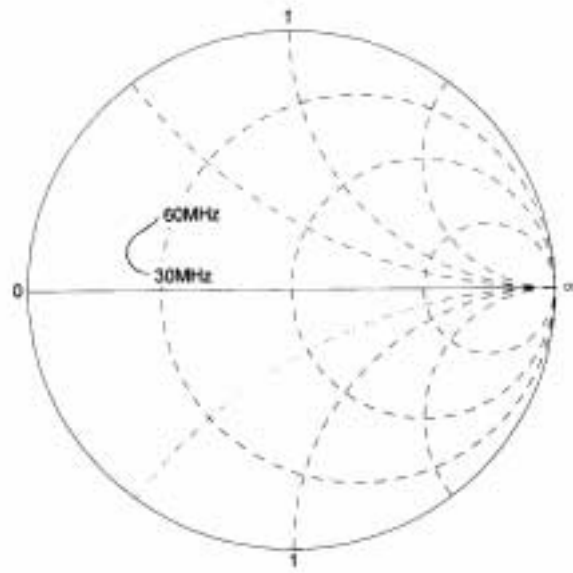

Figure 8. IF Output

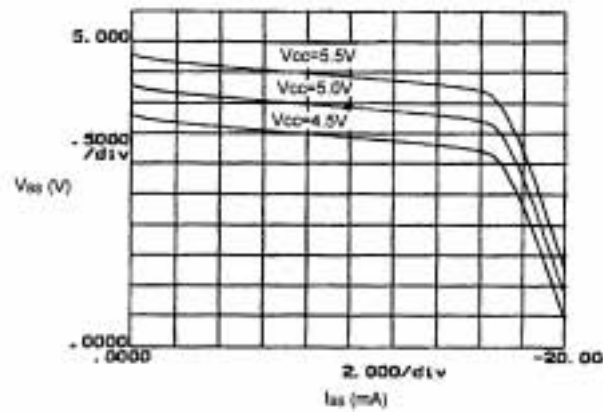

Figure 9. Band Switch Driver Output Voltage (BS1–BS4)

PACKAGING INFORMATION

Orderable Device	Status (1)	Package Type	Package Drawing	Pins	Package Qty	Eco Plan (2)	Lead/Ball Finish (6)	MSL Peak Temp (3)	Op Temp (°C)	Device Marking (4/5)	Samples
SN761677DA	OBSOLETE	TSSOP	DA	38		TBD	Call TI	Call TI	-20 to 85	SN761677	
SN761677DAR	OBSOLETE	TSSOP	DA	38		TBD	Call TI	Call TI	-20 to 85	SN761677	
SN761677DBTR	OBSOLETE	TSSOP	DBT	38		TBD	Call TI	Call TI		B1677	

(1) The marketing status values are defined as follows:

ACTIVE: Product device recommended for new designs.

LIFEBUY: TI has announced that the device will be discontinued, and a lifetime-buy period is in effect.

NRND: Not recommended for new designs. Device is in production to support existing customers, but TI does not recommend using this part in a new design.

PREVIEW: Device has been announced but is not in production. Samples may or may not be available.

OBSOLETE: TI has discontinued the production of the device.

(2) Eco Plan - The planned eco-friendly classification: Pb-Free (RoHS), Pb-Free (RoHS Exempt), or Green (RoHS & no Sb/Br) - please check <http://www.ti.com/productcontent> for the latest availability information and additional product content details.

TBD: The Pb-Free/Green conversion plan has not been defined.

Pb-Free (RoHS): TI's terms "Lead-Free" or "Pb-Free" mean semiconductor products that are compatible with the current RoHS requirements for all 6 substances, including the requirement that lead not exceed 0.1% by weight in homogeneous materials. Where designed to be soldered at high temperatures, TI Pb-Free products are suitable for use in specified lead-free processes.

Pb-Free (RoHS Exempt): This component has a RoHS exemption for either 1) lead-based flip-chip solder bumps used between the die and package, or 2) lead-based die adhesive used between the die and leadframe. The component is otherwise considered Pb-Free (RoHS compatible) as defined above.

Green (RoHS & no Sb/Br): TI defines "Green" to mean Pb-Free (RoHS compatible), and free of Bromine (Br) and Antimony (Sb) based flame retardants (Br or Sb do not exceed 0.1% by weight in homogeneous material)

(3) MSL, Peak Temp. - The Moisture Sensitivity Level rating according to the JEDEC industry standard classifications, and peak solder temperature.

(4) There may be additional marking, which relates to the logo, the lot trace code information, or the environmental category on the device.

(5) Multiple Device Markings will be inside parentheses. Only one Device Marking contained in parentheses and separated by a "~" will appear on a device. If a line is indented then it is a continuation of the previous line and the two combined represent the entire Device Marking for that device.

(6) Lead/Ball Finish - Orderable Devices may have multiple material finish options. Finish options are separated by a vertical ruled line. Lead/Ball Finish values may wrap to two lines if the finish value exceeds the maximum column width.

Important Information and Disclaimer: The information provided on this page represents TI's knowledge and belief as of the date that it is provided. TI bases its knowledge and belief on information provided by third parties, and makes no representation or warranty as to the accuracy of such information. Efforts are underway to better integrate information from third parties. TI has taken and continues to take reasonable steps to provide representative and accurate information but may not have conducted destructive testing or chemical analysis on incoming materials and chemicals. TI and TI suppliers consider certain information to be proprietary, and thus CAS numbers and other limited information may not be available for release.

In no event shall TI's liability arising out of such information exceed the total purchase price of the TI part(s) at issue in this document sold by TI to Customer on an annual basis.

DA (R-PDSO-G**)
 38 PIN SHOWN

PLASTIC SMALL-OUTLINE PACKAGE

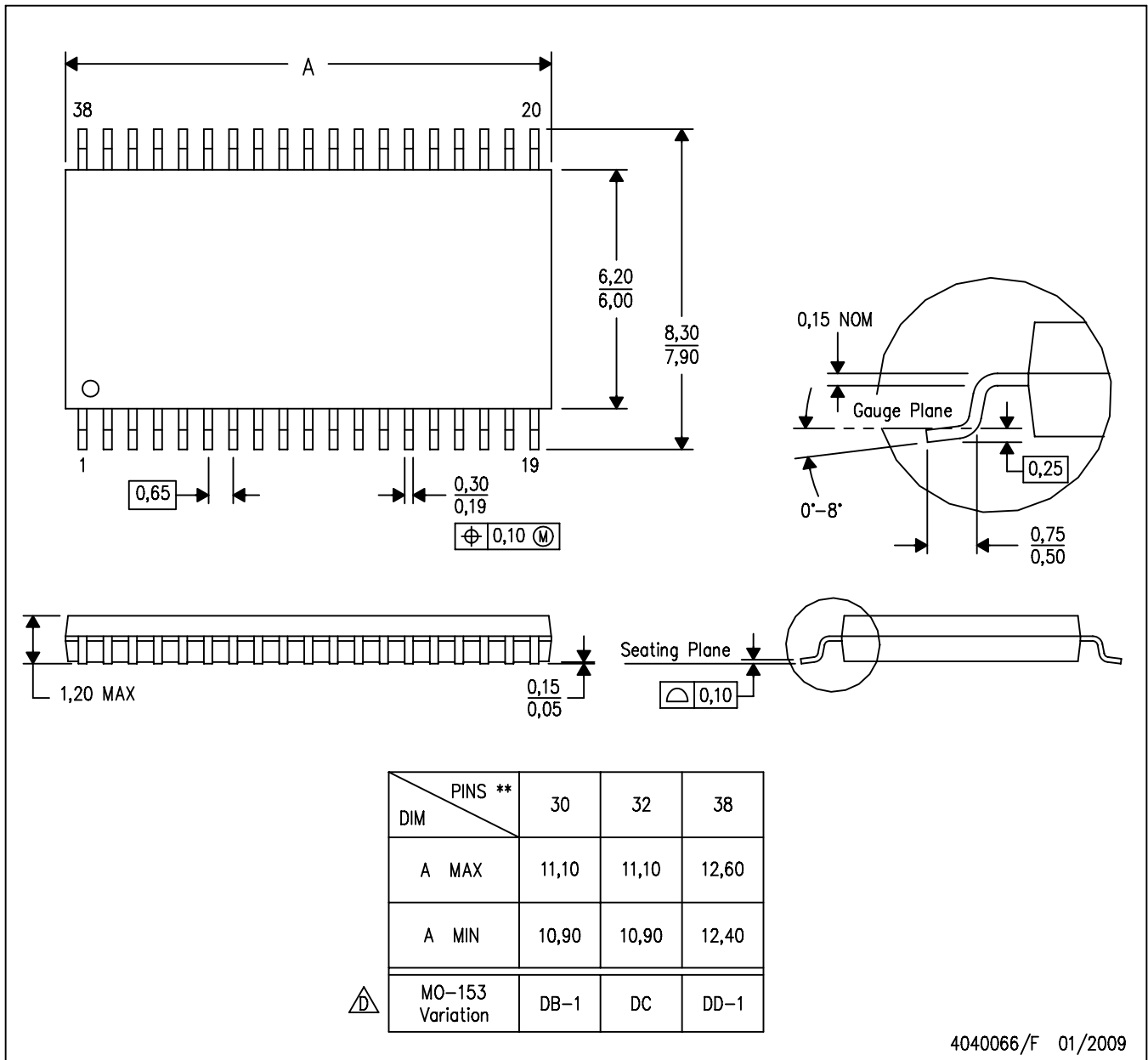

- NOTES:
- A. All linear dimensions are in millimeters.
 - B. This drawing is subject to change without notice.
 - C. Body dimensions do not include mold flash or protrusion. Mold flash and protrusion shall not exceed 0.15 per side.
 - Falls within JEDEC MO-153, except 30 pin body length.

IMPORTANT NOTICE

Texas Instruments Incorporated and its subsidiaries (TI) reserve the right to make corrections, enhancements, improvements and other changes to its semiconductor products and services per JESD46, latest issue, and to discontinue any product or service per JESD48, latest issue. Buyers should obtain the latest relevant information before placing orders and should verify that such information is current and complete. All semiconductor products (also referred to herein as "components") are sold subject to TI's terms and conditions of sale supplied at the time of order acknowledgment.

TI warrants performance of its components to the specifications applicable at the time of sale, in accordance with the warranty in TI's terms and conditions of sale of semiconductor products. Testing and other quality control techniques are used to the extent TI deems necessary to support this warranty. Except where mandated by applicable law, testing of all parameters of each component is not necessarily performed.

TI assumes no liability for applications assistance or the design of Buyers' products. Buyers are responsible for their products and applications using TI components. To minimize the risks associated with Buyers' products and applications, Buyers should provide adequate design and operating safeguards.

TI does not warrant or represent that any license, either express or implied, is granted under any patent right, copyright, mask work right, or other intellectual property right relating to any combination, machine, or process in which TI components or services are used. Information published by TI regarding third-party products or services does not constitute a license to use such products or services or a warranty or endorsement thereof. Use of such information may require a license from a third party under the patents or other intellectual property of the third party, or a license from TI under the patents or other intellectual property of TI.

Reproduction of significant portions of TI information in TI data books or data sheets is permissible only if reproduction is without alteration and is accompanied by all associated warranties, conditions, limitations, and notices. TI is not responsible or liable for such altered documentation. Information of third parties may be subject to additional restrictions.

Resale of TI components or services with statements different from or beyond the parameters stated by TI for that component or service voids all express and any implied warranties for the associated TI component or service and is an unfair and deceptive business practice. TI is not responsible or liable for any such statements.

Buyer acknowledges and agrees that it is solely responsible for compliance with all legal, regulatory and safety-related requirements concerning its products, and any use of TI components in its applications, notwithstanding any applications-related information or support that may be provided by TI. Buyer represents and agrees that it has all the necessary expertise to create and implement safeguards which anticipate dangerous consequences of failures, monitor failures and their consequences, lessen the likelihood of failures that might cause harm and take appropriate remedial actions. Buyer will fully indemnify TI and its representatives against any damages arising out of the use of any TI components in safety-critical applications.

In some cases, TI components may be promoted specifically to facilitate safety-related applications. With such components, TI's goal is to help enable customers to design and create their own end-product solutions that meet applicable functional safety standards and requirements. Nonetheless, such components are subject to these terms.

No TI components are authorized for use in FDA Class III (or similar life-critical medical equipment) unless authorized officers of the parties have executed a special agreement specifically governing such use.

Only those TI components which TI has specifically designated as military grade or "enhanced plastic" are designed and intended for use in military/aerospace applications or environments. Buyer acknowledges and agrees that any military or aerospace use of TI components which have **not** been so designated is solely at the Buyer's risk, and that Buyer is solely responsible for compliance with all legal and regulatory requirements in connection with such use.

TI has specifically designated certain components as meeting ISO/TS16949 requirements, mainly for automotive use. In any case of use of non-designated products, TI will not be responsible for any failure to meet ISO/TS16949.

Products

Audio	www.ti.com/audio
Amplifiers	amplifier.ti.com
Data Converters	dataconverter.ti.com
DLP® Products	www.dlp.com
DSP	dsp.ti.com
Clocks and Timers	www.ti.com/clocks
Interface	interface.ti.com
Logic	logic.ti.com
Power Mgmt	power.ti.com
Microcontrollers	microcontroller.ti.com
RFID	www.ti-rfid.com
OMAP Applications Processors	www.ti.com/omap
Wireless Connectivity	www.ti.com/wirelessconnectivity

Applications

Automotive and Transportation	www.ti.com/automotive
Communications and Telecom	www.ti.com/communications
Computers and Peripherals	www.ti.com/computers
Consumer Electronics	www.ti.com/consumer-apps
Energy and Lighting	www.ti.com/energy
Industrial	www.ti.com/industrial
Medical	www.ti.com/medical
Security	www.ti.com/security
Space, Avionics and Defense	www.ti.com/space-avionics-defense
Video and Imaging	www.ti.com/video

TI E2E Community

e2e.ti.com

Looking for pricing, stock, or lifecycle information?

Click below to explore more details on WIN SOURCE:

 [View SN761677DA on WIN SOURCE](#)

 [Texas Instruments](#) Information

Optimize Your Supply Chain with WIN SOURCE Solutions

-  Global Sourcing Solution
-  Obsolete Management
-  Cost Control Management
-  Shortage Management
-  Alternative Solution
-  Excess Inventory Management