



**THE DATASHEET OF
SN75LVDS83DGG**



- 4:28 Data Channel Compression at up to 238 MBytes/s Throughput
- Suited for SVGA, XGA, or SXGA Display Data Transmission From Controller to Display With Very Low EMI
- 28 Data Channels and Clock-In Low-Voltage TTL
- 4 Data Channels and Clock-Out Low-Voltage Differential
- Operates From a Single 3.3-V Supply With 250 mW (Typ)
- ESD Protection Exceeds 6 kV
- 5-V Tolerant Data Inputs
- Selectable Rising or Falling Edge-Triggered Inputs
- Packaged in Thin Shrink Small-Outline Package With 20-Mil Terminal Pitch
- Consumes Less Than 1 mW When Disabled
- Wide Phase-Lock Input Frequency Range . . . 31 MHz to 68 MHz
- No External Components Required for PLL
- Outputs Meet or Exceed the Requirements of ANSI EIA/TIA-644 Standard
- Improved Replacement for the DS90C581

description

The SN75LVDS83 FlatLink transmitter contains four 7-bit parallel-load serial-out shift registers, a 7× clock synthesizer, and five low-voltage differential-signaling (LVDS) line drivers in a single integrated circuit. These functions allow 28 bits of single-ended low-voltage TTL (LVTTTL) data to be synchronously transmitted over five balanced-pair conductors for receipt by a compatible receiver, such as the SN75LVDS82. The SN75LVDS83 can also be used in 21-bit links with the SN75LVDS86 receiver.

When transmitting, data bits D0 through D27 are each loaded into registers upon the edge of the input clock signal (CLKIN). The rising or falling edge of the clock can be selected by way of the clock select (CLKSEL) terminal. The frequency of CLKIN is multiplied seven times (7×) and then used to unload the data registers in 7-bit slices and serially. The four serial streams and a phase-locked clock (CLKOUT) are then output to LVDS output drivers. The frequency of CLKOUT is the same as the input clock, CLKIN.

The SN75LVDS83 requires no external components and little or no control. The data bus appears the same at the input to the transmitter and output of the receiver with the data transmission transparent to the user. The only user intervention is the possible use of the shutdown/clear (SHTDN) active-low input to inhibit the clock and shut off the LVDS output drivers for lower power consumption. A low-level signal on SHTDN clears all internal registers to a low level.

The SN75LVDS83 is characterized for operation over free-air temperature ranges of 0°C to 70°C.

DGG PACKAGE (TOP VIEW)

V _{CC}	1	56	D4
D5	2	55	D3
D6	3	54	D2
D7	4	53	GND
GND	5	52	D1
D8	6	51	D0
D9	7	50	D27
D10	8	49	LVDSGND
V _{CC}	9	48	Y0M
D11	10	47	Y0P
D12	11	46	Y1M
D13	12	45	Y1P
GND	13	44	LVDSV _{CC}
D14	14	43	LVDSGND
D15	15	42	Y2M
D16	16	41	Y2P
CLKSEL	17	40	CLKOUTM
D17	18	39	CLKOUTP
D18	19	38	Y3M
D19	20	37	Y3P
GND	21	36	LVDSGND
D20	22	35	PLL _{GND}
D21	23	34	PLL _{V_{CC}}
D22	24	33	PLL _{GND}
D23	25	32	SHTDN
V _{CC}	26	31	CLKIN
D24	27	30	D26
D25	28	29	GND



Please be aware that an important notice concerning availability, standard warranty, and use in critical applications of Texas Instruments semiconductor products and disclaimers thereto appears at the end of this data sheet.

FlatLink is a registered trademark of Texas Instruments.

PRODUCTION DATA information is current as of publication date. Products conform to specifications per the terms of Texas Instruments standard warranty. Production processing does not necessarily include testing of all parameters.



POST OFFICE BOX 655303 • DALLAS, TEXAS 75265

Copyright © 1997 – 2009, Texas Instruments Incorporated

SN75LVDS83 FlatLink™ TRANSMITTER

SLLS2711 – MARCH 1997 – REVISED MAY 2009

functional block diagram

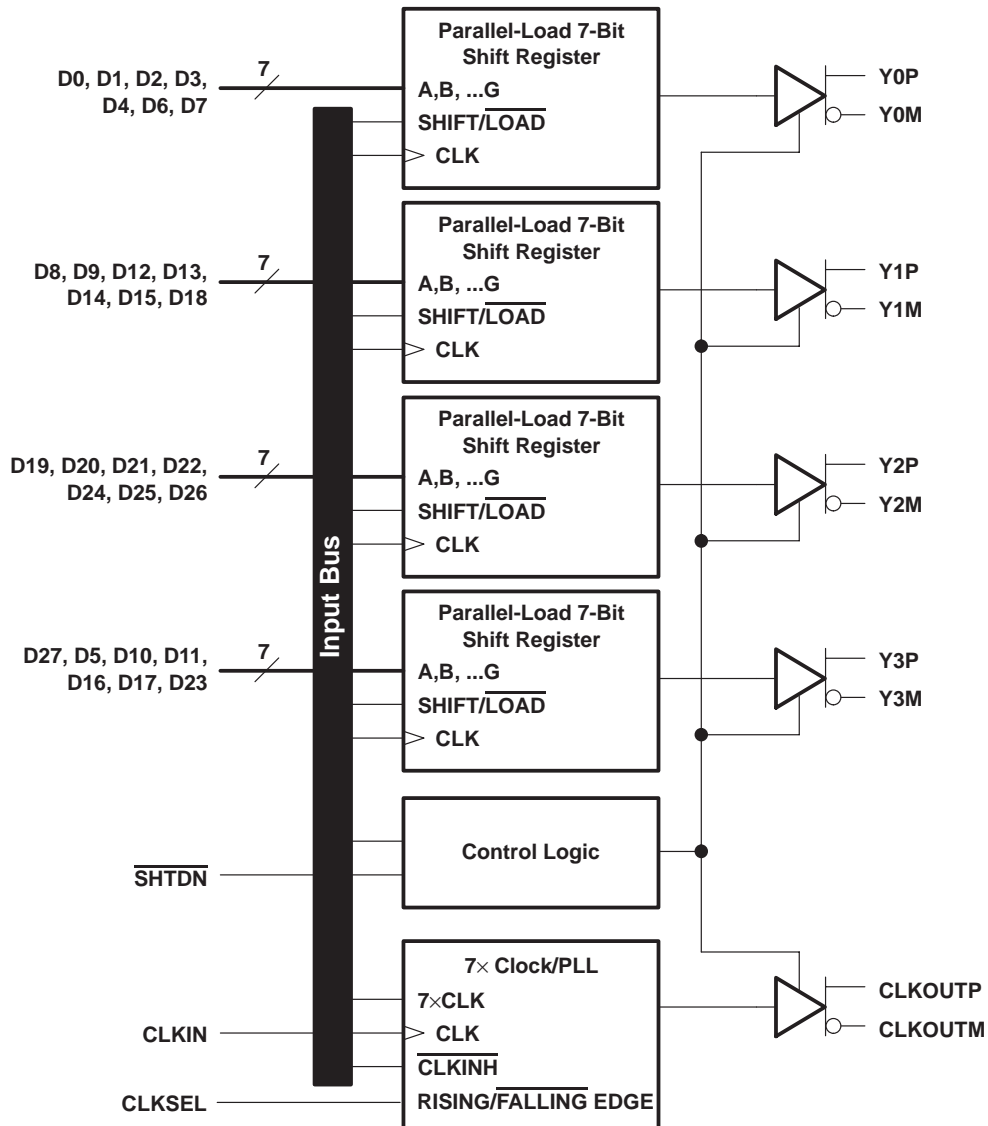

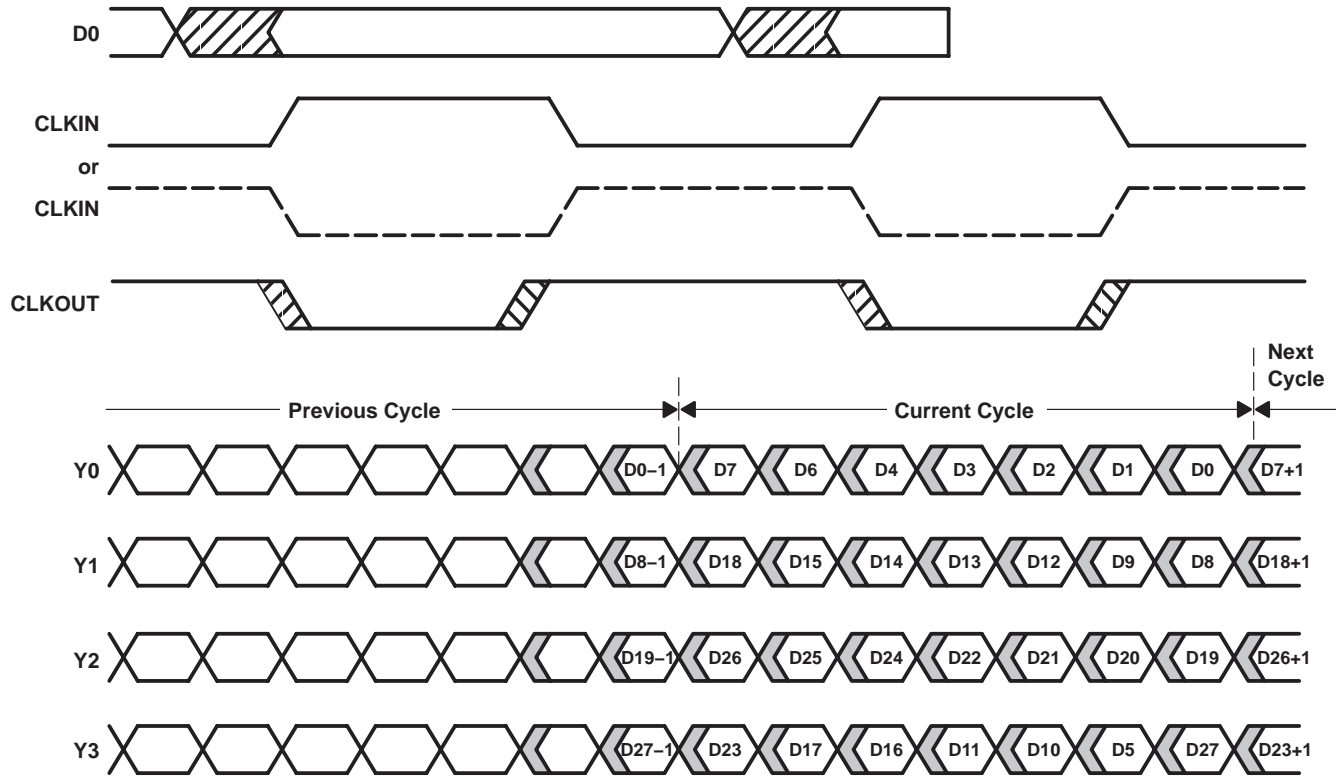
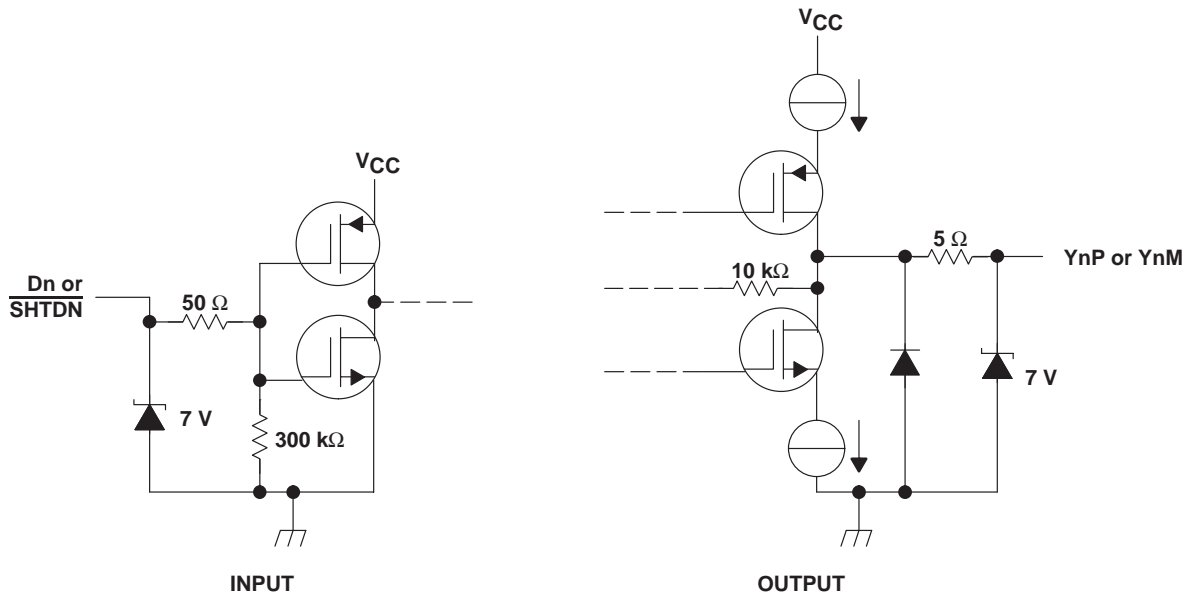

Figure 1. SN75LVDS83 Load and Shift Timing Sequences

equivalent input and output schematic diagrams



SN75LVDS83
FlatLink™ TRANSMITTER

SLLS2711 – MARCH 1997 – REVISED MAY 2009

absolute maximum ratings over operating free-air temperature (unless otherwise noted)†

Supply voltage range, V_{CC} (see Note 1)	-0.5 V to 4 V
Output voltage range, V_O (all terminals)	-0.5 V to $V_{CC} + 0.5$ V
Input voltage range, V_I (all terminals)	-0.5 V to 5.5 V
Continuous total power dissipation	See Dissipation Rating Table
Storage temperature range, T_{stg}	-65°C to 150°C
Lead temperature 1,6 mm (1/16 inch) from case for 10 seconds	260°C

† Stresses beyond those listed under “absolute maximum ratings” may cause permanent damage to the device. These are stress ratings only, and functional operation of the device at these or any other conditions beyond those indicated under “recommended operating conditions” is not implied. Exposure to absolute-maximum-rated conditions for extended periods may affect device reliability.

NOTE 1: All voltage values are with respect to the GND terminals.

DISSIPATION RATING TABLE

PACKAGE	$T_A \leq 25^\circ\text{C}$ POWER RATING	DERATING FACTOR‡ ABOVE $T_A = 25^\circ\text{C}$	$T_A = 70^\circ\text{C}$ POWER RATING
DGG	1377 mW	11.0 mW/°C	822 mW

‡ This is the inverse of the junction-to-ambient thermal resistance when board mounted and with no air flow.

recommended operating conditions

	MIN	NOM	MAX	UNIT
Supply voltage, V_{CC}	3	3.3	3.6	V
High-level input voltage, V_{IH}	2			V
Low-level input voltage, V_{IL}			0.8	V
Differential load impedance, Z_L	90		132	Ω
Operating free-air temperature, T_A	0		70	°C

timing requirements

	MIN	NOM	MAX	UNIT
t_c Cycle time, input clock	14.7		32.3	ns
t_w Pulse duration, high-level input clock	$0.4 t_c$		$0.6 t_c$	ns
t_t Transition time, input signal			5	ns
t_{su} Setup time, data, D0 – D27 valid before $CLKIN\uparrow$ or $CLKIN\downarrow$ (see Figure 2)	3			ns
t_h Hold time, data, D0 – D27 valid after $CLKIN\uparrow$ or $CLKIN\downarrow$ (see Figure 2)	1.5			ns



electrical characteristics over recommended operating conditions (unless otherwise noted)

PARAMETER		TEST CONDITIONS	MIN	TYP†	MAX	UNIT
V_{IT}	Input threshold voltage			1.4		V
$ V_{OD} $	Differential steady-state output voltage magnitude	$R_L = 100 \Omega$, See Figure 3	247		454	mV
$\Delta V_{OD} $	Change in the steady-state differential output voltage magnitude between opposite binary states				50	mV
$V_{OC(SS)}$	Steady-state common-mode output voltage	See Figure 3	1.125		1.375	V
$V_{OC(PP)}$	Peak-to-peak common-mode output voltage				150	mV
I_{IH}	High-level input current	$V_{IH} = V_{CC}$			25	μA
I_{IL}	Low-level input current	$V_{IL} = 0$			± 10	μA
I_{OS}	Short-circuit output current	$V_O(Y_n) = 0$			± 24	mA
		$V_{OD} = 0$			± 12	mA
I_{OZ}	High-impedance state output current	$V_O = 0$ to V_{CC}			± 10	μA
I_{CC}	Quiescent supply current	Disabled, All inputs at GND			280	μA
		Enabled, $R_L = 100 \Omega$, Gray-scale pattern (see Figure 4), $V_{CC} = 3.3 V$, $t_c = 15.38 ns$		72	90	mA
		Enabled, $R_L = 100 \Omega$, Worst-case pattern (see Figure 5), $t_c = 15.38 ns$		85	110	mA
C_I	Input capacitance			3		pF

† All typical values are at $V_{CC} = 3.3 V$, $T_A = 25^\circ C$.

SN75LVDS83

FlatLink™ TRANSMITTER

SLLS2711 – MARCH 1997 – REVISED MAY 2009

switching characteristics over recommended operating conditions (unless otherwise noted)

PARAMETER	TEST CONDITIONS	MIN	TYP†	MAX	UNIT
t_{d0} Delay time, CLKOUT↑ to serial bit position 0	$t_C = 15.38 \text{ ns } (\pm 0.2\%),$ Input clock jitter < 50 ps‡, See Figure 6	-0.2	0	0.2	ns
t_{d1} Delay time, CLKOUT↑ to serial bit position 1		$\frac{1}{7}t_C - 0.2$		$\frac{1}{7}t_C + 0.2$	ns
t_{d2} Delay time, CLKOUT↑ to serial bit position 2		$\frac{2}{7}t_C - 0.2$		$\frac{2}{7}t_C + 0.2$	ns
t_{d3} Delay time, CLKOUT↑ to serial bit position 3		$\frac{3}{7}t_C - 0.2$		$\frac{3}{7}t_C + 0.2$	ns
t_{d4} Delay time, CLKOUT↑ to serial bit position 4		$\frac{4}{7}t_C - 0.2$		$\frac{4}{7}t_C + 0.2$	ns
t_{d5} Delay time, CLKOUT↑ to serial bit position 5		$\frac{5}{7}t_C - 0.2$		$\frac{5}{7}t_C + 0.2$	ns
t_{d6} Delay time, CLKOUT↑ to serial bit position 6		$\frac{6}{7}t_C - 0.2$		$\frac{6}{7}t_C + 0.2$	ns
$t_{sk(o)}$ Output skew, $t_n - \frac{n}{7}t_C$		-0.2		0.2	ns
t_{d7} Delay time, CLKIN↓ to CLKOUT↑	$t_C = 18.51 \text{ ns } (\pm 0.2\%),$ Input clock jitter < 50 ps‡, See Figure 6	3.75	5.6	7.75	ns
$\Delta t_{C(o)}$ Cycle time, output clock jitter§	$t_C = 15.38 \pm 0.75 \sin(2\pi 500E3t) + 0.05 \text{ ns},$ See Figure 7		±70		ps
	$t_C = 15.38 \pm 0.75 \sin(2\pi 3E6t) + 0.05 \text{ ns},$ See Figure 7		±187		ps
t_w Pulse duration, high-level output clock			$\frac{4}{7}t_C$		ns
t_t Transition time, differential output (t_r or t_f)	See Figure 3	260	700	1500	ps
t_{en} Enable time, SHTDN↑ to phase lock (Yn valid)	See Figure 8		1		ms
t_{dis} Disable time, SHTDN↓ to off state (CLKOUT low)	See Figure 9		250		ns

† All typical values are at $V_{CC} = 3.3 \text{ V}$, $T_A = 25^\circ\text{C}$.

‡ |Input clock jitter| is the magnitude of the change in the input clock period.

§ Output clock jitter is the change in the output clock period from one cycle to the next cycle observed over 15000 cycles.

PARAMETER MEASUREMENT INFORMATION

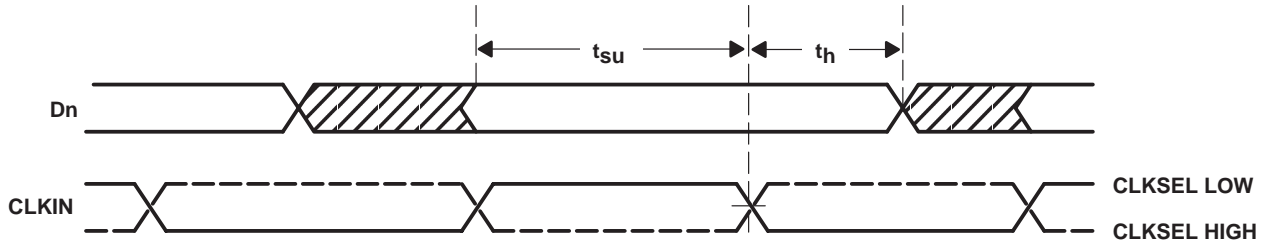

NOTE A: All input timing is defined at 1.4 V on an input signal with a 10%-to-90% rise or fall time of less than 5 ns.

Figure 2. Setup and Hold Time Waveforms

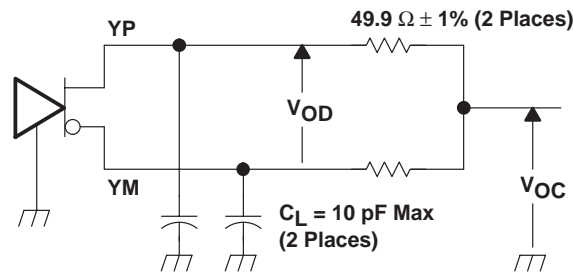

NOTE A: The lumped instrumentation capacitance for any single-ended voltage measurement is less than or equal to 10 pF. When making measurements at YP or YM, the complementary output is similarly loaded.

(a) SCHEMATIC

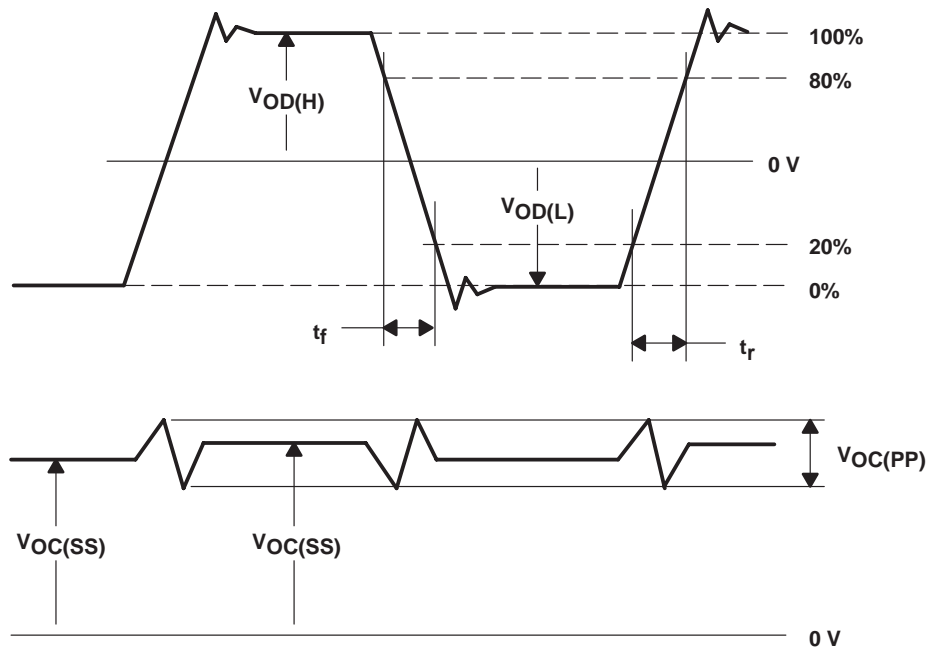

(b) WAVEFORMS

Figure 3. Test Load and Voltage Waveforms for LVDS Outputs

PARAMETER MEASUREMENT INFORMATION

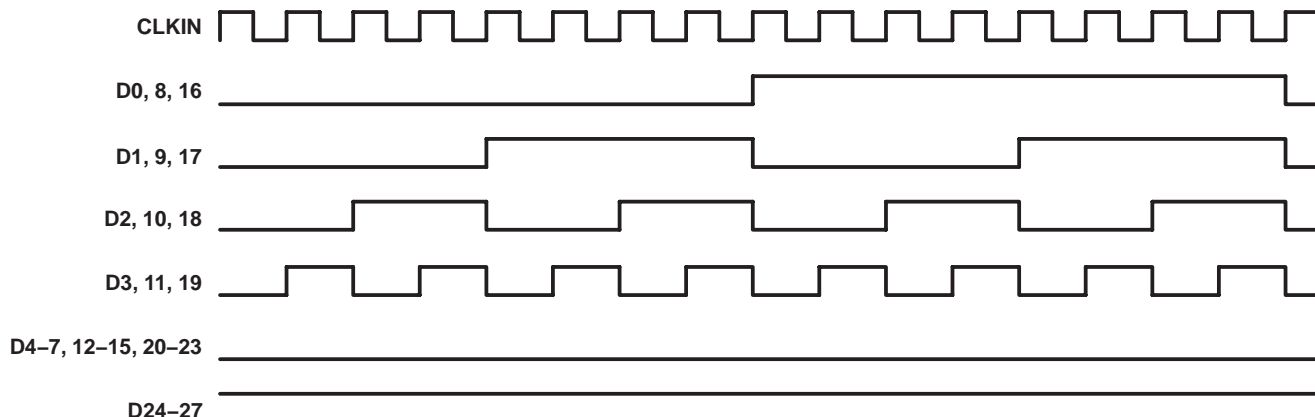

NOTE A: The 16-grayscale test-pattern test device power consumption for a typical display pattern. Pattern with CLKSEL low shown.

Figure 4. 16-Grayscale Test-Pattern Waveforms

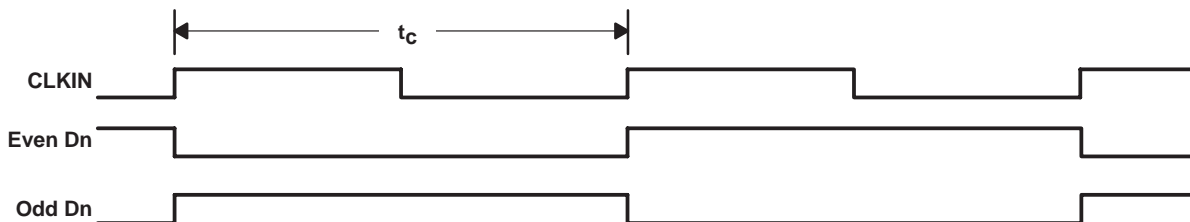

NOTE A: The worst-case test pattern produces nearly the maximum switching frequency for all of the LVDS outputs. Pattern with CLKSEL low shown.

Figure 5. Worst-Case Test-Pattern Waveforms

PARAMETER MEASUREMENT INFORMATION

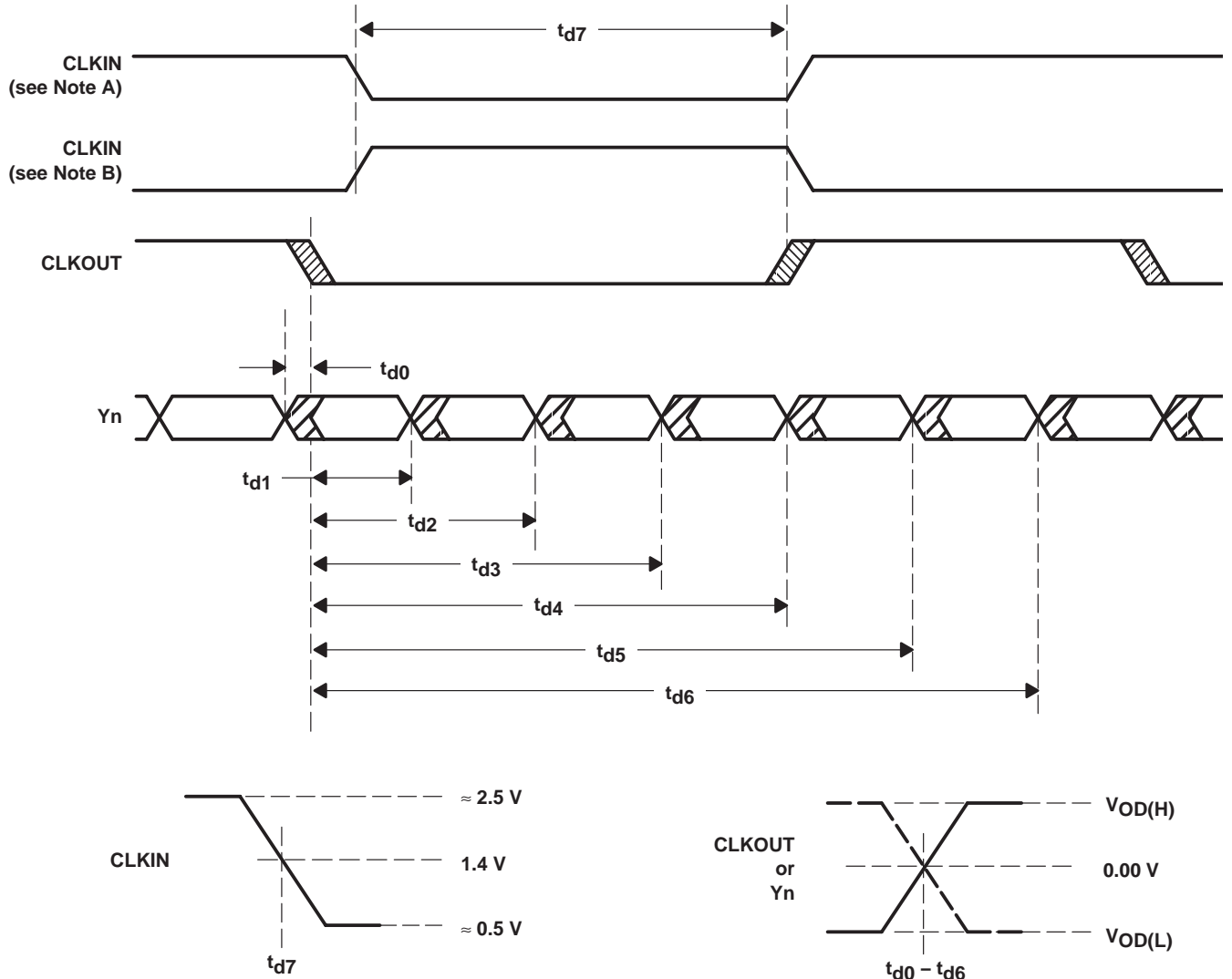

NOTES: A. This wave form is valid when CLKSEL is low.
B. This wave form is valid when CLKSEL is high.

Figure 6. SN75LVDS83 Timing Waveforms

PARAMETER MEASUREMENT INFORMATION

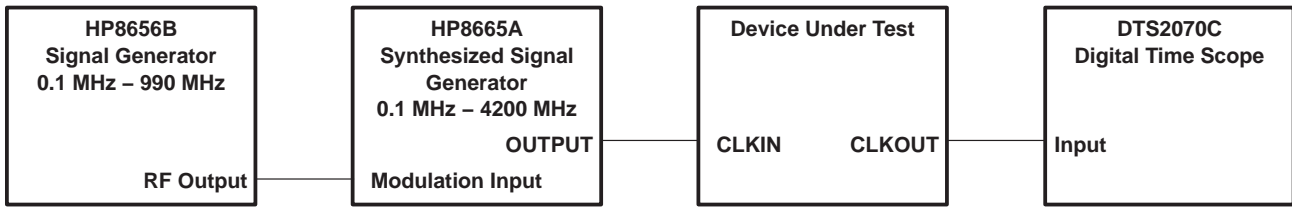
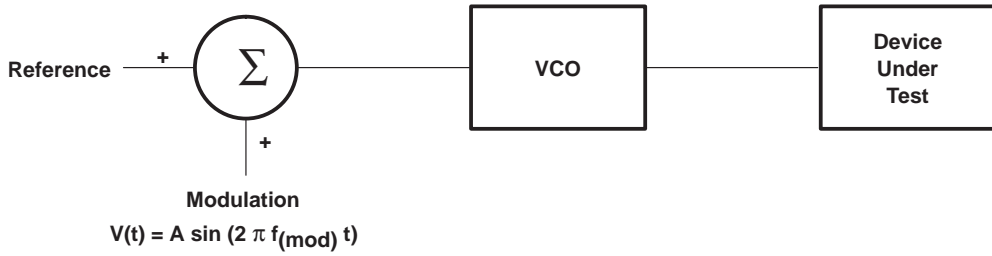

Figure 7. Output Clock Jitter Testing

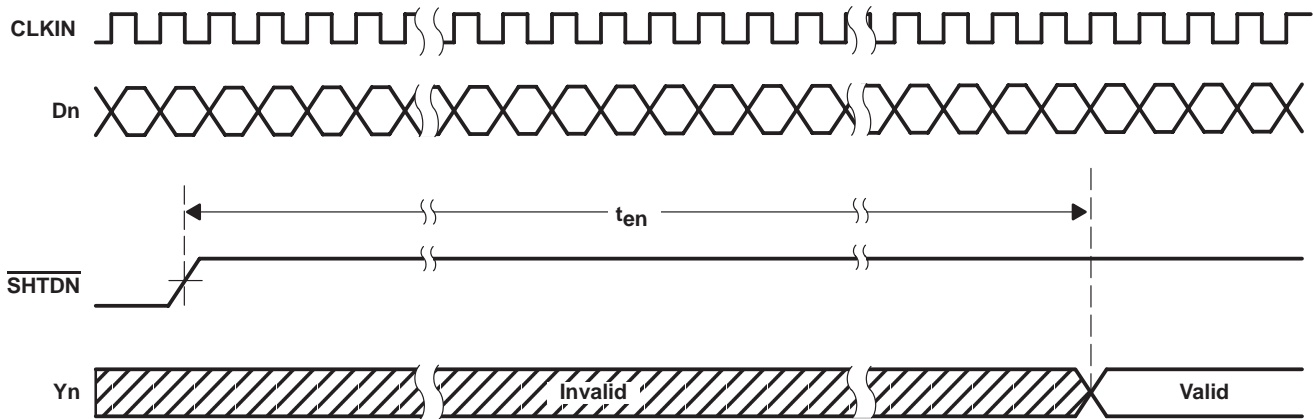

Figure 8. Enable Time Waveforms

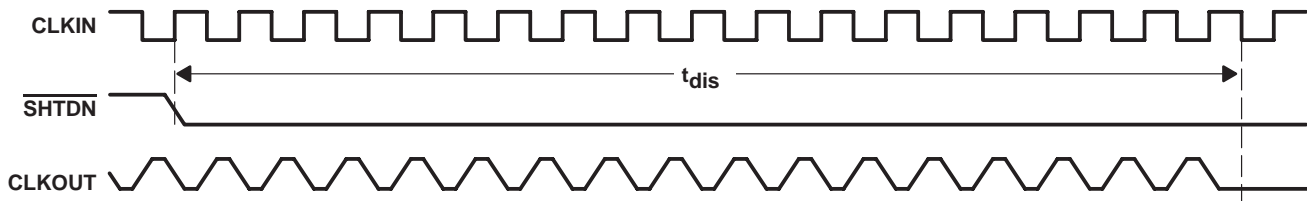

Figure 9. Disable Time Waveforms

TYPICAL CHARACTERISTICS

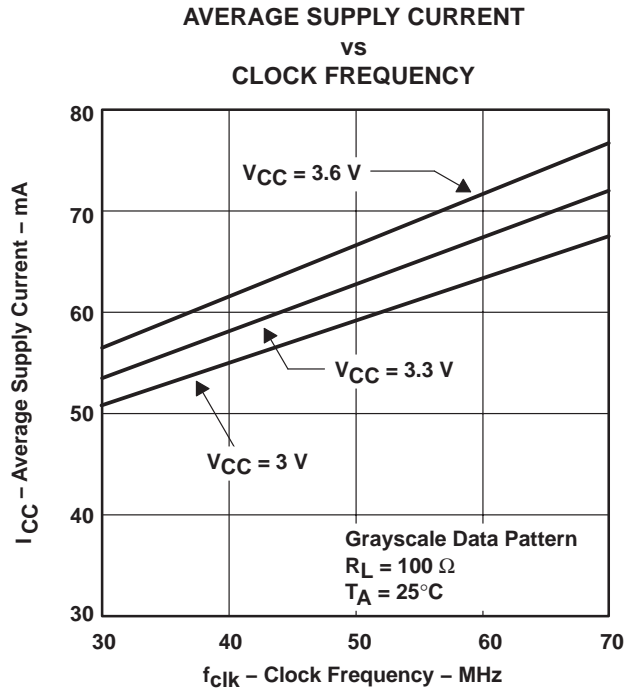

Figure 10

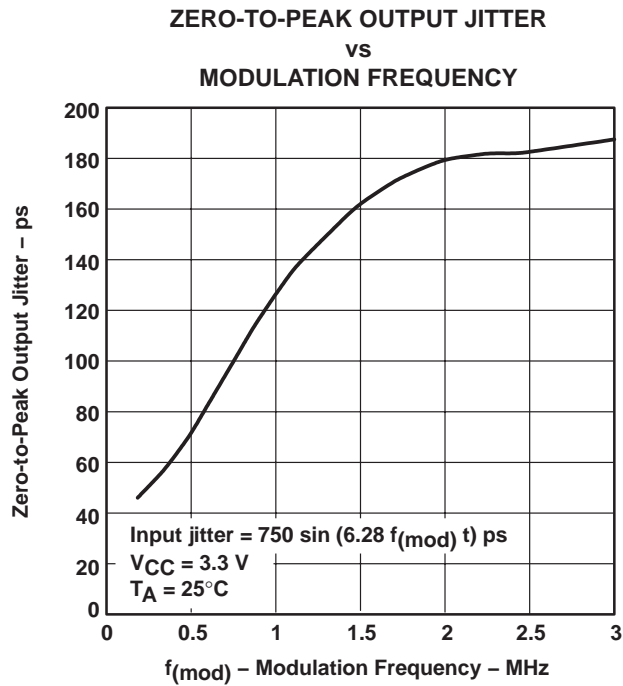
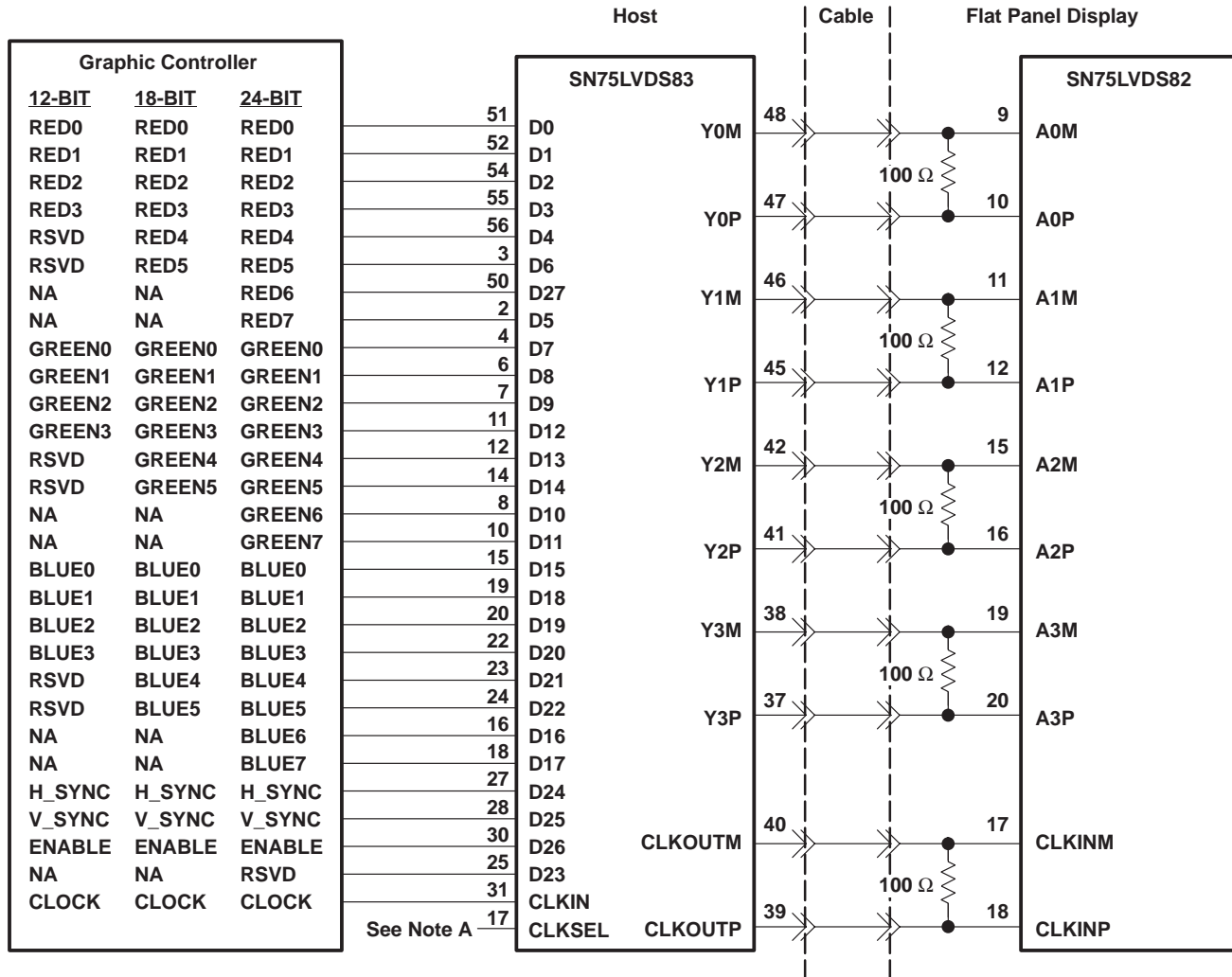

Figure 11

SN75LVDS83
FlatLink™ TRANSMITTER

SLLS2711 – MARCH 1997 – REVISED MAY 2009

APPLICATION INFORMATION



NOTES: A. Connect this terminal to V_{CC} for triggering to the rising edge of the input clock and to GND for the falling edge.
B. The five 100- Ω terminating resistors are recommended to be 0603 types.

Figure 12. 24-Bit Color Host To 24-Bit LCD Panel Display Application

APPLICATION INFORMATION

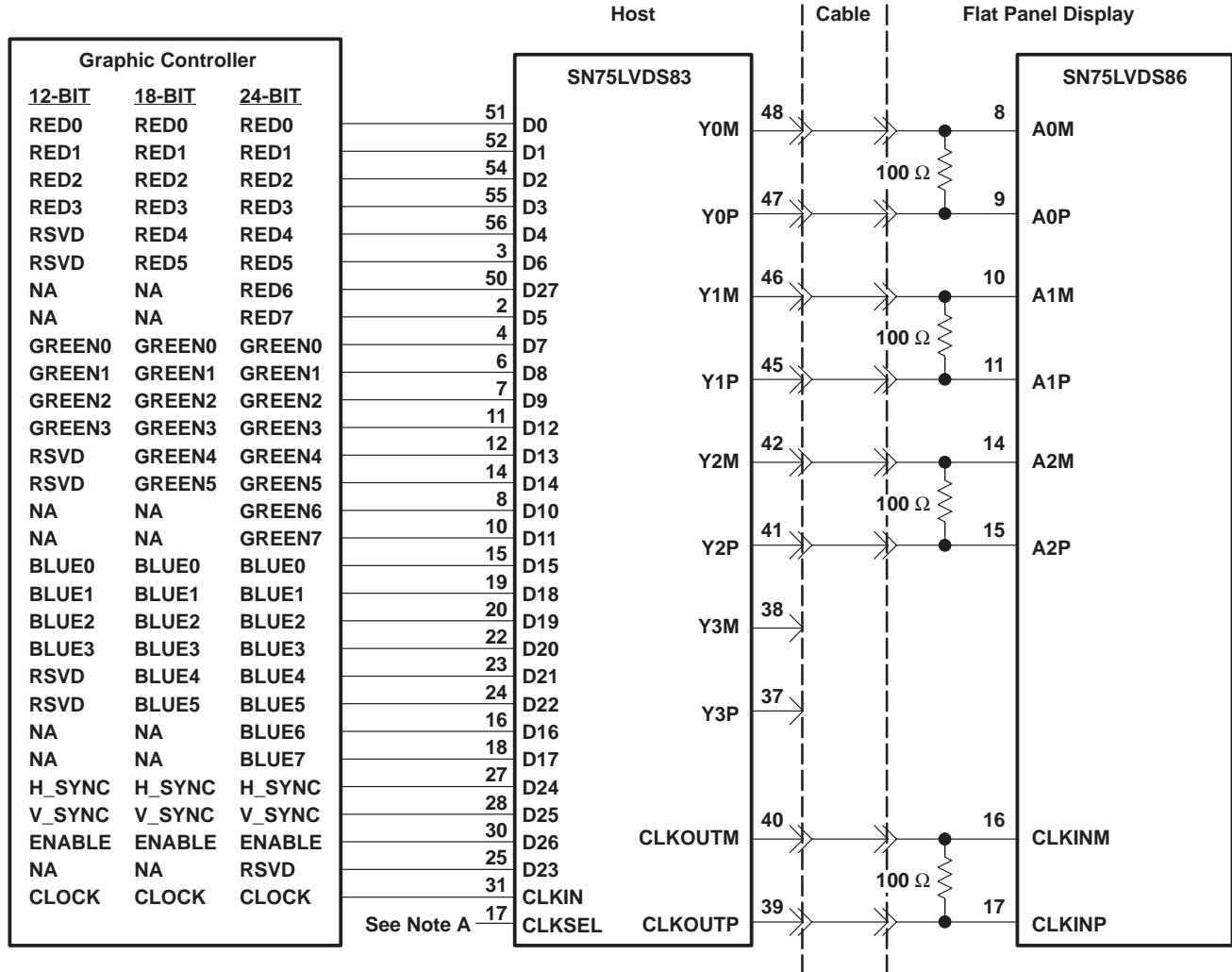

NOTES: A. Connect this terminal to V_{CC} for triggering to the rising edge of the input clock and to GND for the falling edge.
 B. The four 100-Ω terminating resistors are recommended to be 0603 types.

Figure 13. 24-Bit Color Host To 18-Bit LCD Panel Display Application

PACKAGING INFORMATION

Orderable Device	Status (1)	Package Type	Package Drawing	Pins	Package Qty	Eco Plan (2)	Lead/Ball Finish (6)	MSL Peak Temp (3)	Op Temp (°C)	Device Marking (4/5)	Samples
SN75LVDS83DGG	NRND	TSSOP	DGG	56	35	Green (RoHS & no Sb/Br)	CU NIPDAU	Level-2-260C-1 YEAR	0 to 70	SN75LVDS83	
SN75LVDS83DGGG4	NRND	TSSOP	DGG	56	35	Green (RoHS & no Sb/Br)	CU NIPDAU	Level-2-260C-1 YEAR	0 to 70	SN75LVDS83	
SN75LVDS83DGGR	NRND	TSSOP	DGG	56	2000	Green (RoHS & no Sb/Br)	CU NIPDAU	Level-2-260C-1 YEAR	0 to 70	SN75LVDS83	

(1) The marketing status values are defined as follows:

ACTIVE: Product device recommended for new designs.

LIFEBUY: TI has announced that the device will be discontinued, and a lifetime-buy period is in effect.

NRND: Not recommended for new designs. Device is in production to support existing customers, but TI does not recommend using this part in a new design.

PREVIEW: Device has been announced but is not in production. Samples may or may not be available.

OBSOLETE: TI has discontinued the production of the device.

(2) **RoHS:** TI defines "RoHS" to mean semiconductor products that are compliant with the current EU RoHS requirements for all 10 RoHS substances, including the requirement that RoHS substance do not exceed 0.1% by weight in homogeneous materials. Where designed to be soldered at high temperatures, "RoHS" products are suitable for use in specified lead-free processes. TI may reference these types of products as "Pb-Free".

RoHS Exempt: TI defines "RoHS Exempt" to mean products that contain lead but are compliant with EU RoHS pursuant to a specific EU RoHS exemption.

Green: TI defines "Green" to mean the content of Chlorine (Cl) and Bromine (Br) based flame retardants meet JS709B low halogen requirements of <=1000ppm threshold. Antimony trioxide based flame retardants must also meet the <=1000ppm threshold requirement.

(3) MSL, Peak Temp. - The Moisture Sensitivity Level rating according to the JEDEC industry standard classifications, and peak solder temperature.

(4) There may be additional marking, which relates to the logo, the lot trace code information, or the environmental category on the device.

(5) Multiple Device Markings will be inside parentheses. Only one Device Marking contained in parentheses and separated by a "~" will appear on a device. If a line is indented then it is a continuation of the previous line and the two combined represent the entire Device Marking for that device.

(6) Lead/Ball Finish - Orderable Devices may have multiple material finish options. Finish options are separated by a vertical ruled line. Lead/Ball Finish values may wrap to two lines if the finish value exceeds the maximum column width.

Important Information and Disclaimer: The information provided on this page represents TI's knowledge and belief as of the date that it is provided. TI bases its knowledge and belief on information provided by third parties, and makes no representation or warranty as to the accuracy of such information. Efforts are underway to better integrate information from third parties. TI has taken and continues to take reasonable steps to provide representative and accurate information but may not have conducted destructive testing or chemical analysis on incoming materials and chemicals. TI and TI suppliers consider certain information to be proprietary, and thus CAS numbers and other limited information may not be available for release.

In no event shall TI's liability arising out of such information exceed the total purchase price of the TI part(s) at issue in this document sold by TI to Customer on an annual basis.

TAPE AND REEL INFORMATION



QUADRANT ASSIGNMENTS FOR PIN 1 ORIENTATION IN TAPE



*All dimensions are nominal

Device	Package Type	Package Drawing	Pins	SPQ	Reel Diameter (mm)	Reel Width W1 (mm)	A0 (mm)	B0 (mm)	K0 (mm)	P1 (mm)	W (mm)	Pin1 Quadrant
SN75LVDS83DGGR	TSSOP	DGG	56	2000	330.0	24.4	8.6	15.6	1.8	12.0	24.0	Q1

TAPE AND REEL BOX DIMENSIONS



*All dimensions are nominal

Device	Package Type	Package Drawing	Pins	SPQ	Length (mm)	Width (mm)	Height (mm)
SN75LVDS83DGGR	TSSOP	DGG	56	2000	350.0	350.0	43.0

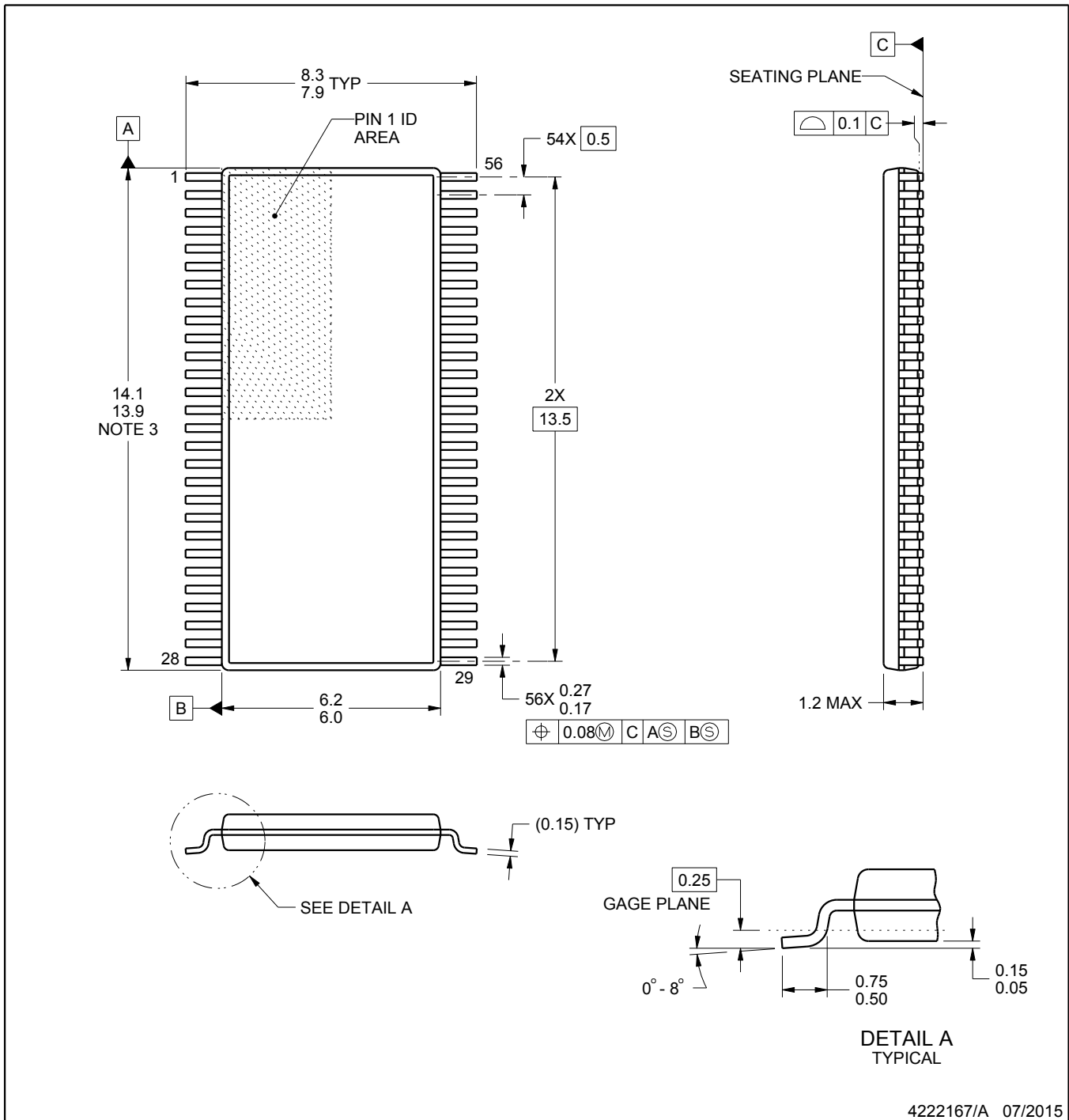

4222167/A 07/2015

NOTES:

1. All linear dimensions are in millimeters. Any dimensions in parenthesis are for reference only. Dimensioning and tolerancing per ASME Y14.5M.
2. This drawing is subject to change without notice.
3. This dimension does not include mold flash, protrusions, or gate burrs. Mold flash, protrusions, or gate burrs shall not exceed 0.15 mm per side.
4. Reference JEDEC registration MO-153.

EXAMPLE BOARD LAYOUT

DGG0056A

TSSOP - 1.2 mm max height

SMALL OUTLINE PACKAGE

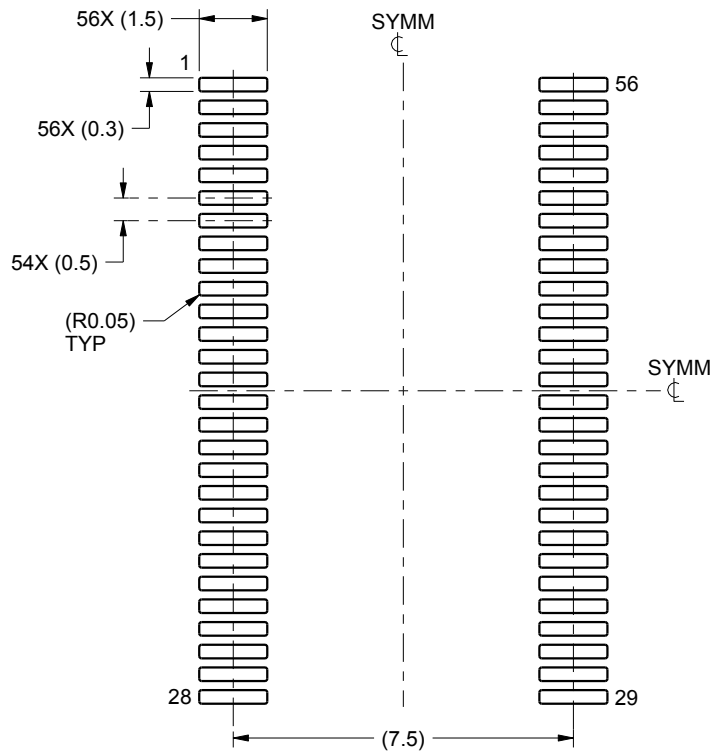

LAND PATTERN EXAMPLE
SCALE:6X

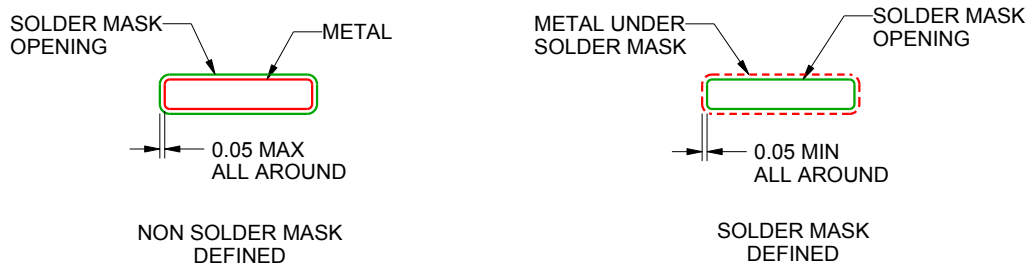

SOLDER MASK DETAILS

4222167/A 07/2015

NOTES: (continued)

- 5. Publication IPC-7351 may have alternate designs.
- 6. Solder mask tolerances between and around signal pads can vary based on board fabrication site.

EXAMPLE STENCIL DESIGN

DGG0056A

TSSOP - 1.2 mm max height

SMALL OUTLINE PACKAGE

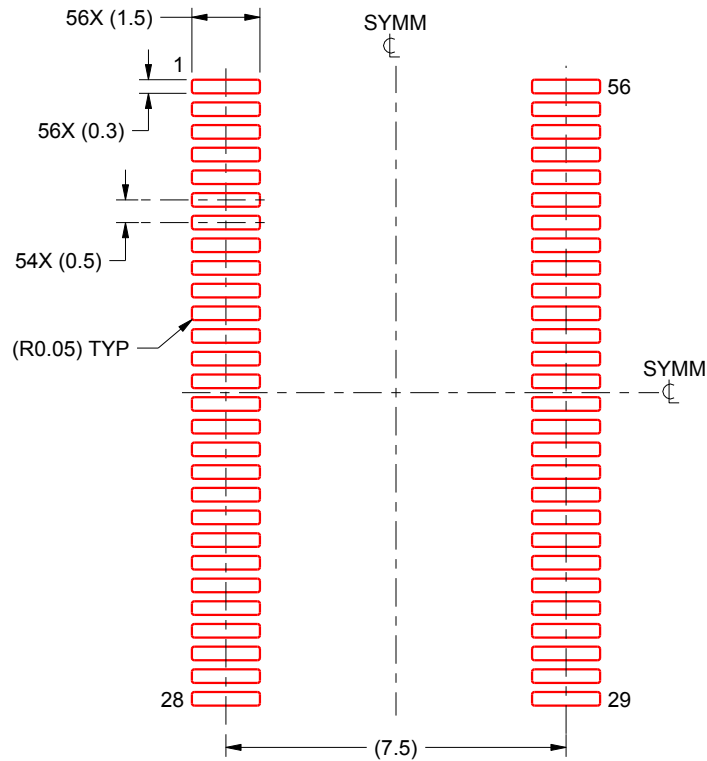

SOLDER PASTE EXAMPLE
BASED ON 0.125 mm THICK STENCIL
SCALE:6X

4222167/A 07/2015

NOTES: (continued)

7. Laser cutting apertures with trapezoidal walls and rounded corners may offer better paste release. IPC-7525 may have alternate design recommendations.
8. Board assembly site may have different recommendations for stencil design.

IMPORTANT NOTICE AND DISCLAIMER

TI PROVIDES TECHNICAL AND RELIABILITY DATA (INCLUDING DATASHEETS), DESIGN RESOURCES (INCLUDING REFERENCE DESIGNS), APPLICATION OR OTHER DESIGN ADVICE, WEB TOOLS, SAFETY INFORMATION, AND OTHER RESOURCES "AS IS" AND WITH ALL FAULTS, AND DISCLAIMS ALL WARRANTIES, EXPRESS AND IMPLIED, INCLUDING WITHOUT LIMITATION ANY IMPLIED WARRANTIES OF MERCHANTABILITY, FITNESS FOR A PARTICULAR PURPOSE OR NON-INFRINGEMENT OF THIRD PARTY INTELLECTUAL PROPERTY RIGHTS.

These resources are intended for skilled developers designing with TI products. You are solely responsible for (1) selecting the appropriate TI products for your application, (2) designing, validating and testing your application, and (3) ensuring your application meets applicable standards, and any other safety, security, or other requirements. These resources are subject to change without notice. TI grants you permission to use these resources only for development of an application that uses the TI products described in the resource. Other reproduction and display of these resources is prohibited. No license is granted to any other TI intellectual property right or to any third party intellectual property right. TI disclaims responsibility for, and you will fully indemnify TI and its representatives against, any claims, damages, costs, losses, and liabilities arising out of your use of these resources.

TI's products are provided subject to TI's Terms of Sale (www.ti.com/legal/termsofsale.html) or other applicable terms available either on ti.com or provided in conjunction with such TI products. TI's provision of these resources does not expand or otherwise alter TI's applicable warranties or warranty disclaimers for TI products.

Mailing Address: Texas Instruments, Post Office Box 655303, Dallas, Texas 75265
Copyright © 2019, Texas Instruments Incorporated

Looking for pricing, stock, or lifecycle information?

Click below to explore more details on WIN SOURCE:

 [View SN75LVDS83DGG on WIN SOURCE](#)

 [Texas Instruments](#) Information

Optimize Your Supply Chain with WIN SOURCE Solutions

-  Global Sourcing Solution
-  Obsolete Management
-  Cost Control Management
-  Shortage Management
-  Alternative Solution
-  Excess Inventory Management