



**THE DATASHEET OF
SN74LVC08AD**



SN74LVC08A Quadruple 2-Input Positive-AND Gates

1 Features

- Operate From 1.65 V to 3.6 V
- Specified From -40°C to 85°C , -40°C to 125°C , and -55°C to 125°C
- Inputs Accept Voltages to 5.5 V
- Max t_{pd} of 4.1 ns at 3.3 V
- Typical V_{OLP} (Output Ground Bounce) <0.8 V at $V_{CC} = 3.3$ V, $T_A = 25^{\circ}\text{C}$
- Typical V_{OHV} (Output V_{OH} Undershoot) >2 V at $V_{CC} = 3.3$ V, $T_A = 25^{\circ}\text{C}$
- I_{off} Support Live Insertion, Partial-Power-Down Mode and Back-Drive Protection
- Latch-Up Performance Exceeds 250 mA Per JESD 17
- ESD Protection Exceeds JESD 22
 - 2000-V Human-Body Model (A114-A)
 - 200-V Machine Model (A115-A)
 - 1000-V Charged-Device Model (C101)
 - On Products Compliant to MIL-PRF-38535, All Parameters Are Tested Unless Otherwise Noted. On All Other Products, Production Processing Does Not Necessarily Include Testing of All Parameters.

2 Applications

- Servers
- LED Displays
- Network Switches
- I/O expanders
- Base station processor board

3 Description

The SN54LVC08A quadruple 2-input positive-AND gate is designed for 2.7-V to 3.6-V V_{CC} operation, and the SN74LVC08A quadruple 2-input positive-AND gate is designed for 1.65-V to 3.6-V V_{CC} operation.

The LVC08A devices perform the Boolean function $Y = A \cdot B$ or $Y = \overline{A} + \overline{B}$ in positive logic.

Inputs can be driven from either 3.3-V or 5-V devices. This feature allows the use of these devices as translators in a mixed 3.3-V/5-V system environment.

Device Information⁽¹⁾

PART NUMBER	PACKAGE	BODY SIZE (NOM)
SNJ54LVC08A	CFP (14)	9.21 mm × 5.97 mm
	CDIP (14)	19.56 mm × 6.92 mm
	LCCC (20)	8.89 mm × 8.89 mm
SN74LVC08A	VQFN (14)	3.50 mm × 3.50 mm
	TSSOP (14)	5.00 mm × 4.40 mm
	SOP (14)	10.30 mm × 5.30 mm
	SOIC (14)	8.65 mm × 3.91 mm
	SSOP (14)	6.20 mm × 5.30 mm

(1) For all available packages, see the orderable addendum at the end of the data sheet.

Logic Diagram, Each Gate (Positive Logic)



Table of Contents

1 Features	1	9 Detailed Description	10
2 Applications	1	9.1 Overview	10
3 Description	1	9.2 Functional Block Diagram	10
4 Revision History	2	9.3 Feature Description	10
5 Device Options	3	9.4 Device Functional Modes	10
6 Pin Configuration and Functions	4	10 Application and Implementation	11
7 Specifications	5	10.1 Application Information	11
7.1 Absolute Maximum Ratings	5	10.2 Typical Application	11
7.2 ESD Ratings	5	11 Power Supply Recommendations	12
7.3 Recommended Operating Conditions for SN54LVC08A	5	12 Layout	12
7.4 Recommended Operating Conditions for SN74LVC08A	6	12.1 Layout Guidelines	12
7.5 Thermal Information	6	12.2 Layout Examples	12
7.6 Electrical Characteristics for SN54LVC08A	7	13 Device and Documentation Support	13
7.7 Electrical Characteristics for SN74LVC08A	7	13.1 Related Links	13
7.8 Switching Characteristics for SN54LVC08A	7	13.2 Community Resources	13
7.9 Switching Characteristics for SN74LVC08A	8	13.3 Trademarks	13
7.10 Operating Characteristics	8	13.4 Electrostatic Discharge Caution	13
7.11 Typical Characteristics	8	13.5 Glossary	13
8 Parameter Measurement Information	9	14 Mechanical, Packaging, and Orderable Information	13

4 Revision History

NOTE: Page numbers for previous revisions may differ from page numbers in the current version.

Changes from Revision R (June 2015) to Revision S	Page
• Added T_J junction temperature spec to Abs Max Ratings	5

Changes from Revision Q (November 2010) to Revision R	Page
• Updated document to new TI data sheet format - no specification changes.	1
• Added <i>Applications</i> , <i>Device Information</i> table, <i>Pin Configuration and Functions</i> section, <i>ESD Ratings</i> table, <i>Feature Description</i> section, <i>Device Functional Modes</i> , <i>Application and Implementation</i> section, <i>Power Supply Recommendations</i> section, <i>Layout</i> section, <i>Device and Documentation Support</i> section, and <i>Mechanical, Packaging, and Orderable Information</i> section	1
• Added Military Disclaimer to <i>Features</i>	1
• Added <i>Thermal Information</i> table	6

5 Device Options

PART NUMBER	PACKAGE	BODY SIZE
SNJ54LVC08AW	CFP (14)	9.21 mm × 5.97 mm
SNJ54LVC08AJ	CDIP (14)	19.56 mm × 6.92 mm
SNJ54LVC08AFK	LCCC (20)	8.89 mm × 8.89 mm
SN74LVC08ARGYR	VQFN (14)	3.50 mm × 3.50 mm
SN74LVC08APW	TSSOP (14)	5.00 mm × 4.40 mm
SN74LVC08APWT		
SN74LVC08APWG3		
SN74LVC08ANSR	SOP (14)	10.30 mm × 5.30 mm
SN74LVC08AD	SOIC (14)	8.65 mm × 3.91 mm
SN74LVC08ADT		
SN74LVC08ADRG3		
SN74LVC08ADBR	SSOP (14)	6.20 mm × 5.30 mm

6 Pin Configuration and Functions

D, DB, NS, J, W, or PW Package
14-Pin SOIC, SSOP, SOP, CDIP, or TSSOP
Top View

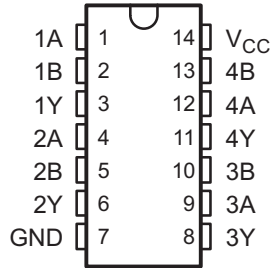

RGY Package
14-Pin VQFN
Top View

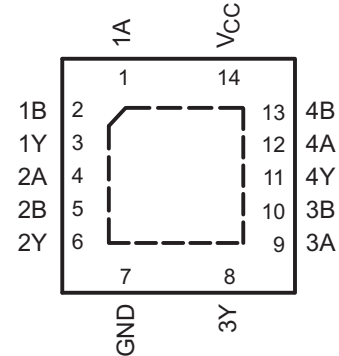

FK Package
20-Pin LCCC
Top View

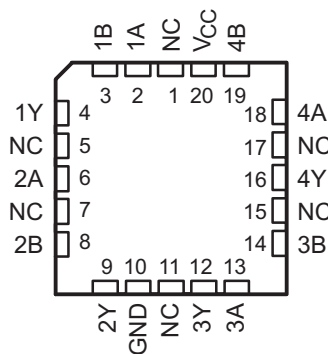

Pin Functions

PIN				
NAME	SOIC, SSOP, SOP, CDIP, or TSSOP	LCCC	TYPE	DESCRIPTION
1A	1	2	I	AND Gate Input
1B	2	3	I	AND Gate Input
1Y	3	4	O	AND Gate Output
2A	4	6	I	AND Gate Input
2B	5	8	I	AND Gate Input
2Y	6	9	O	AND Gate Output
GND	7	10	Ground	Ground pin for the device
3Y	8	12	O	AND Gate Output
3A	9	13	I	AND Gate Input
3B	10	14	I	AND Gate Input
4Y	11	16	O	AND Gate Output
4A	12	18	I	AND Gate Input
4B	13	19	I	AND Gate Input
V _{CC}	14	20	Power	Power pin for the device

Pin Functions (continued)

PIN		LCCC	TYPE	DESCRIPTION
NAME	SOIC, SSOP, SOP, CDIP, or TSSOP			
NC ⁽¹⁾	—	1	—	No connect
		5		
		7		
		11		
		15		
		17		

(1) NC – No internal connection

7 Specifications

7.1 Absolute Maximum Ratings

over operating free-air temperature range (unless otherwise noted)⁽¹⁾

		MIN	MAX	UNIT	
V _{CC}	Supply voltage	-0.5	6.5	V	
V _I	Input voltage ⁽²⁾	-0.5	6.5	V	
V _O	Output voltage ⁽²⁾⁽³⁾	-0.5	V _{CC} + 0.5	V	
I _{IK}	Input clamp current	V _I < 0		-50	mA
I _{OK}	Output clamp current	V _O < 0		-50	mA
I _O	Continuous output current			±50	mA
Continuous current through V _{CC} or GND				±100	mA
P _{tot}	Power dissipation ⁽⁴⁾⁽⁵⁾	T _A = -40°C to 125°C		500	mW
T _J	Junction temperature	-65	150	°C	
T _{stg}	Storage temperature	-65	150	°C	

- (1) Stresses beyond those listed under *Absolute Maximum Ratings* may cause permanent damage to the device. These are stress ratings only, and functional operation of the device at these or any other conditions beyond those indicated under *Recommended Operating Conditions* is not implied. Exposure to absolute-maximum-rated conditions for extended periods may affect device reliability.
- (2) The input and output negative-voltage ratings may be exceeded if the input and output current ratings are observed.
- (3) The value of V_{CC} is provided in the *Recommended Operating Conditions* table.
- (4) For the D package: above 70°C, the value of P_{tot} derates linearly with 8 mW/K.
- (5) For the DB, NS, and PW packages: above 60°C, the value of P_{tot} derates linearly with 5.5 mW/K.

7.2 ESD Ratings

		VALUE	UNIT
V _(ESD)	Electrostatic discharge	Human body model (HBM), per ANSI/ESDA/JEDEC JS-001 ⁽¹⁾	±2000
		Charged-device model (CDM), per JEDEC specification JESD22-C101 ⁽²⁾	±1000

- (1) JEDEC document JEP155 states that 500-V HBM allows safe manufacturing with a standard ESD control process.
- (2) JEDEC document JEP157 states that 250-V CDM allows safe manufacturing with a standard ESD control process.

7.3 Recommended Operating Conditions for SN54LVC08A⁽¹⁾

		SN54LVC08A		UNIT
		-55°C to 125°C		
		MIN	MAX	
V _{CC}	Supply voltage	Operating	2	3.6
		Data retention only	1.5	
V _{IH}	High-level input voltage	V _{CC} = 2.7 V to 3.6 V		2
V _{IL}	Low-level input voltage	V _{CC} = 2.7 V to 3.6 V		0.8

- (1) All unused inputs of the device must be held at V_{CC} or GND to ensure proper device operation. Refer to the TI application report, *Implications of Slow or Floating CMOS Inputs*, SCBA004.

Recommended Operating Conditions for SN54LVC08A⁽¹⁾ (continued)

		SN54LVC08A		UNIT	
		–55°C to 125°C			
		MIN	MAX		
V _I	Input voltage	0	5.5	V	
V _O	Output voltage	0	V _{CC}	V	
I _{OH}	High-level output current	V _{CC} = 2.7 V		–12	mA
		V _{CC} = 3 V		–24	
I _{OL}	Low-level output current	V _{CC} = 2.7 V		12	mA
		V _{CC} = 3 V		24	
Δt/Δv	Input transition rise or fall rate			8	ns/V

7.4 Recommended Operating Conditions for SN74LVC08A⁽¹⁾

		SN74LVC08A						UNIT		
		T _A = 25°C		–40°C to 85°C		–40°C to 125°C				
		MIN	MAX	MIN	MAX	MIN	MAX			
V _{CC}	Supply voltage	Operating		1.65	3.6	1.65	3.6	1.65	3.6	V
	Data retention only		1.5		1.5		1.5			
V _{IH}	High-level input voltage	V _{CC} = 1.65 V to 1.95 V		0.65 × V _{CC}		0.65 × V _{CC}		0.65 × V _{CC}		V
		V _{CC} = 2.3 V to 2.7 V		1.7		1.7		1.7		
		V _{CC} = 2.7 V to 3.6 V		2		2		2		
V _{IL}	Low-level input voltage	V _{CC} = 1.65 V to 1.95 V		0.35 × V _{CC}		0.35 × V _{CC}		0.35 × V _{CC}		V
		V _{CC} = 2.3 V to 2.7 V		0.7		0.7		0.7		
		V _{CC} = 2.7 V to 3.6 V		0.8		0.8		0.8		
V _I	Input voltage	0	5.5	0	5.5	0	5.5	0	5.5	V
V _O	Output voltage	0	V _{CC}	0	V _{CC}	0	V _{CC}	0	V _{CC}	V
I _{OH}	High-level output current	V _{CC} = 1.65 V		–4		–4		–4		mA
		V _{CC} = 2.3 V		–8		–8		–8		
		V _{CC} = 2.7 V		–12		–12		–12		
		V _{CC} = 3 V		–24		–24		–24		
I _{OL}	Low-level output current	V _{CC} = 1.65 V		4		4		4		mA
		V _{CC} = 2.3 V		8		8		8		
		V _{CC} = 2.7 V		12		12		12		
		V _{CC} = 3 V		24		24		24		
Δt/Δv	Input transition rise or fall rate	8		8		8		8		ns/V

(1) All unused inputs of the device must be held at V_{CC} or GND to ensure proper device operation. Refer to the TI application report, *Implications of Slow or Floating CMOS Inputs*, [SCBA004](#).

7.5 Thermal Information

THERMAL METRIC ⁽¹⁾		SN74LVC08A					UNIT
		D (SOIC)	DB (SSOP)	NS (SOP)	PW (TSSOP)	RGY (LCCC)	
		14 PINS	14 PINS	14 PINS	14 PINS	14 PINS	
R _{θJA}	Junction-to-ambient thermal resistance	86	96	76	113	47	°C/W

(1) For more information about traditional and new thermal metrics, see the *Semiconductor and IC Package Thermal Metrics* application report, [SPRA953](#).

7.6 Electrical Characteristics for SN54LVC08A

over recommended operating free-air temperature range (unless otherwise noted)

PARAMETER	TEST CONDITIONS	V _{CC}	SN54LVC08A			UNIT
			–55°C to 125°C			
			MIN	TYP ⁽¹⁾	MAX	
V _{OH}	I _{OH} = –100 μA	2.7 V to 3.6 V	V _{CC} – 0.2			V
	I _{OH} = –12 mA	2.7 V	2.2			
		3 V	2.4			
	I _{OH} = –24 mA	3 V	2.2			
V _{OL}	I _{OL} = 100 μA	2.7 V to 3.6 V	0.2			V
	I _{OL} = 12 mA	2.7 V	0.4			
		3 V	0.55			
	I _{OL} = 24 mA	3 V	0.55			
I _I	V _I = 5.5 V or GND	3.6 V	±5			μA
I _{CC}	V _I = V _{CC} or GND, I _O = 0	3.6 V	10			μA
ΔI _{CC}	One input at V _{CC} – 0.6 V, Other inputs at V _{CC} or GND	2.7 V to 3.6 V	500			μA
C _i	V _I = V _{CC} or GND	3.3 V	5			pF

(1) T_A = 25°C

7.7 Electrical Characteristics for SN74LVC08A

over recommended operating free-air temperature range (unless otherwise noted)

PARAMETER	TEST CONDITIONS	V _{CC}	SN74LVC08A						UNIT	
			T _A = 25°C			–40°C to 85°C		–40°C to 125°C		
			MIN	TYP	MAX	MIN	MAX	MIN		MAX
V _{OH}	I _{OH} = –100 μA	1.65 V to 3.6 V	V _{CC} – 0.2			V _{CC} – 0.2		V _{CC} – 0.3		V
	I _{OH} = –4 mA	1.65 V	1.29			1.2		1.05		
		2.3 V	1.9			1.7		1.55		
	I _{OH} = –12 mA	2.7 V	2.2			2.2		2.05		
		3 V	2.4			2.4		2.25		
	I _{OH} = –24 mA	3 V	2.3			2.2		2		
V _{OL}	I _{OL} = 100 μA	1.65 V to 3.6 V	0.1			0.2		0.3		V
	I _{OL} = 4 mA	1.65 V	0.24			0.45		0.6		
		2.3 V	0.3			0.7		0.75		
	I _{OL} = 12 mA	2.7 V	0.4			0.4		0.6		
		3 V	0.55			0.55		0.8		
	I _{OL} = 24 mA	3 V	0.55			0.55		0.8		
I _I	V _I = 5.5 V or GND	3.6 V	±1			±5		±20		μA
I _{CC}	V _I = V _{CC} or GND, I _O = 0	3.6 V	1			10		40		μA
ΔI _{CC}	One input at V _{CC} – 0.6 V, Other inputs at V _{CC} or GND	2.7 V to 3.6 V	500			500		5000		μA
C _i	V _I = V _{CC} or GND	3.3 V	5							pF

7.8 Switching Characteristics for SN54LVC08A

over recommended operating free-air temperature range (unless otherwise noted) (see [Figure 3](#))

PARAMETER	FROM (INPUT)	TO (OUTPUT)	V _{CC}	SN54LVC08A		UNIT
				–55°C to 125°C		
				MIN	MAX	
t _{pd}	A or B	Y	2.7 V	4.8		ns
			3.3 V ± 0.3 V	1	4.1	

7.9 Switching Characteristics for SN74LVC08A

over recommended operating free-air temperature range (unless otherwise noted) (see Figure 3)

PARAMETER	FROM (INPUT)	TO (OUTPUT)	V _{CC}	SN74LVC08A						UNIT	
				T _A = 25°C			–40°C to 85°C		–40°C to 125°C		
				MIN	TYP	MAX	MIN	MAX	MIN		MAX
t _{pd}	A or B	Y	1.8 V ± 0.15 V	1	5	9.3	1	9.8	1	11.3	ns
			2.5 V ± 0.2 V	1	2.9	6.4	1	6.9	1	9	
			2.7 V	1	3	4.6	1	4.8	1	6	
			3.3 V ± 0.3 V	1	2.6	3.9	1	4.1	1	5.5	
t _{sk(o)}			3.3 V ± 0.3 V					1		1.5	ns

7.10 Operating Characteristics

T_A = 25°C

PARAMETER		TEST CONDITIONS	V _{CC}	TYP	UNIT
C _{pd}	Power dissipation capacitance per gate	f = 10 MHz	1.8 V	7	pF
			2.5 V	9.8	
			3.3 V	10	

7.11 Typical Characteristics

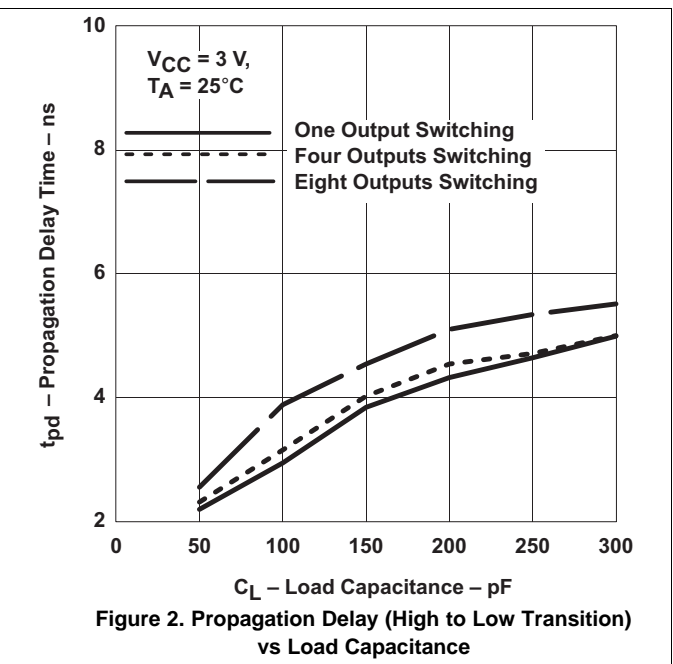
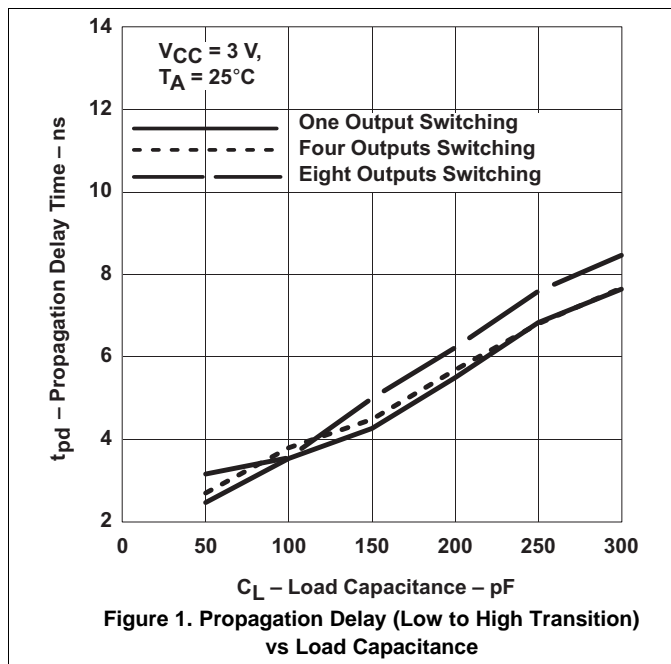

8 Parameter Measurement Information

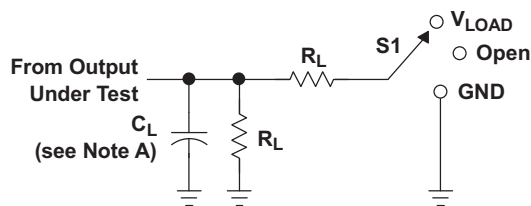

LOAD CIRCUIT

TEST	S1
t_{PLH}/t_{PHL}	Open
t_{PLZ}/t_{PZL}	V_{LOAD}
t_{PHZ}/t_{PZH}	GND

V_{CC}	INPUTS		V_M	V_{LOAD}	C_L	R_L	V_D
	V_I	t_r/t_f					
$1.8\text{ V} \pm 0.15\text{ V}$	V_{CC}	$\leq 2\text{ ns}$	$V_{CC}/2$	$2 \times V_{CC}$	30 pF	1 k Ω	0.15 V
$2.5\text{ V} \pm 0.2\text{ V}$	V_{CC}	$\leq 2\text{ ns}$	$V_{CC}/2$	$2 \times V_{CC}$	30 pF	500 Ω	0.15 V
2.7 V	2.7 V	$\leq 2.5\text{ ns}$	1.5 V	6 V	50 pF	500 Ω	0.3 V
$3.3\text{ V} \pm 0.3\text{ V}$	2.7 V	$\leq 2.5\text{ ns}$	1.5 V	6 V	50 pF	500 Ω	0.3 V

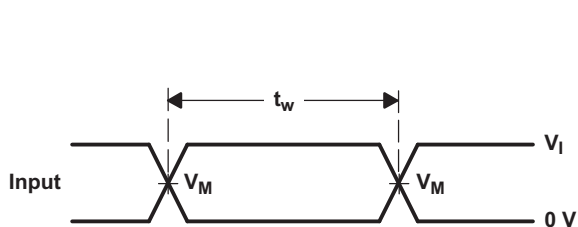

VOLTAGE WAVEFORMS
PULSE DURATION

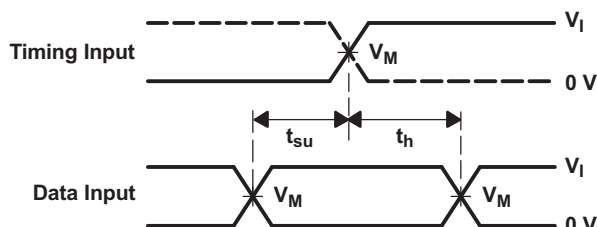

VOLTAGE WAVEFORMS
SETUP AND HOLD TIMES

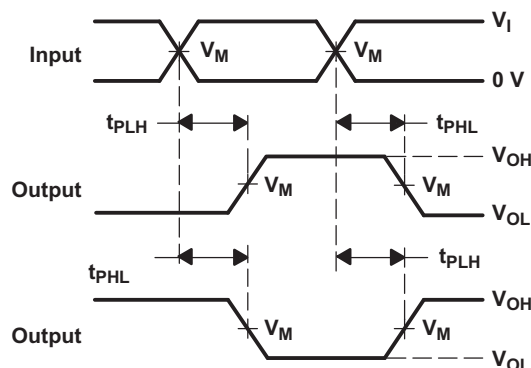

VOLTAGE WAVEFORMS
PROPAGATION DELAY TIMES
INVERTING AND NONINVERTING OUTPUTS

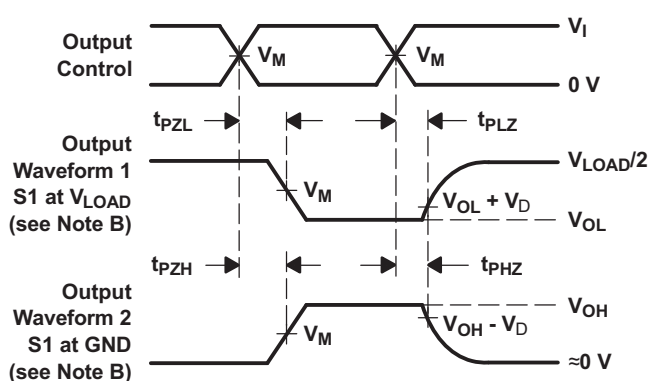

VOLTAGE WAVEFORMS
ENABLE AND DISABLE TIMES
LOW- AND HIGH-LEVEL ENABLING

- NOTES:
- A. C_L includes probe and jig capacitance.
 - B. Waveform 1 is for an output with internal conditions such that the output is low except when disabled by the output control. Waveform 2 is for an output with internal conditions such that the output is high, except when disabled by the output control.
 - C. All input pulses are supplied by generators having the following characteristics: PRR $\leq 10\text{ MHz}$, $Z_O = 50\ \Omega$.
 - D. The outputs are measured one at a time, with one transition per measurement.
 - E. t_{PLZ} and t_{PHZ} are the same as t_{dis} .
 - F. t_{PZL} and t_{PZH} are the same as t_{en} .
 - G. t_{PLH} and t_{PHL} are the same as t_{pd} .
 - H. All parameters and waveforms are not applicable to all devices.

Figure 3. Load Circuit and Voltage Waveforms

9 Detailed Description

9.1 Overview

The SN74LVC08 device contains quadruple 2-input positive AND gate device and performs the Boolean function $Y = A \cdot B$. This device is useful when multiple AND function is used in the system.

9.2 Functional Block Diagram

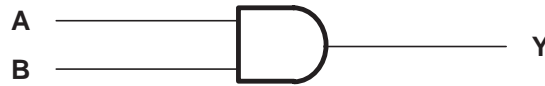

Figure 4. Logic Diagram, Each Gate (Positive Logic)

9.3 Feature Description

The device can operate from 1.65 V to 3.6 V, allowing to be used in low voltage systems.

The device can accept voltages to 5.5 V make this device flexible to connect and work seamlessly with wide voltage range systems.

The maximum t_{pd} of 4.1 ns at 3.3 V is beneficial for use in high speed applications.

The device has a I_{off} support live insertion, a partial-power-down mode, and a back-drive protection.

9.4 Device Functional Modes

[Table 1](#) lists the functional modes for the SN54LVC08A and SN74LVC08A devices.

Table 1. Truth Table

INPUTS		OUTPUT
A	B	Y
H	H	H
L	X	L
X	L	L

10 Application and Implementation

NOTE

Information in the following applications sections is not part of the TI component specification, and TI does not warrant its accuracy or completeness. TI's customers are responsible for determining suitability of components for their purposes. Customers should validate and test their design implementation to confirm system functionality.

10.1 Application Information

The SN74LVC08A is used to drive CMOS device and used for implementing AND logic. LVC family can support current drive of about 24 mA at 3-V V_{CC} . The inputs for SN74LVC08 are 5.5-V tolerant allowing it to translate down to V_{CC} .

10.2 Typical Application

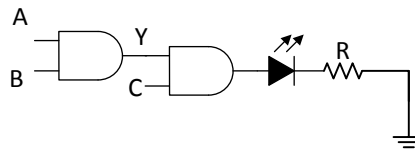

Figure 5. Three Input AND Gate Implementation and Driving LED

10.2.1 Design Requirements

This device uses CMOS technology and has balanced output drive. Take care to avoid bus contention because it can drive currents that would exceed maximum limits. The high drive will also create fast edges into light loads so routing and load conditions should be considered to prevent ringing.

10.2.2 Detailed Design Procedure

SN74LVC08A contains four AND gates in one package which can be used for individual AND function or to implement complex Boolean logic. Figure 5 shows an example of implementing 3input AND function. AB are inputs for AND gate which are connected to another AND gate. $Z = A \cdot B \cdot C$. SN74LVC08A support high drive current of 24 mA which can be used to drive LED's of even Drive low current signal FETs, an example is shown in Figure 5 TI recommends to use a series resistance to limit the current. If V_{CC} is 3 V, and LED current should be 10 mA, and the forward-voltage of LED is 2.5 V, then R as shown in Figure 5 is calculated using Equation 1 below:

$$R = (V_{CC} - V_{LED}) / I \quad (1)$$

$$R = (3 - 2.5) / 0.01 = 50 \Omega$$

Typical Application (continued)

10.2.3 Application Curves

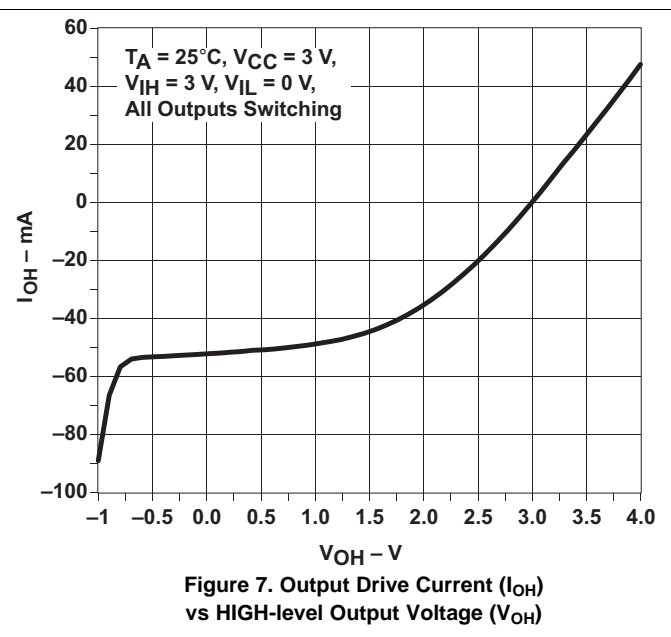
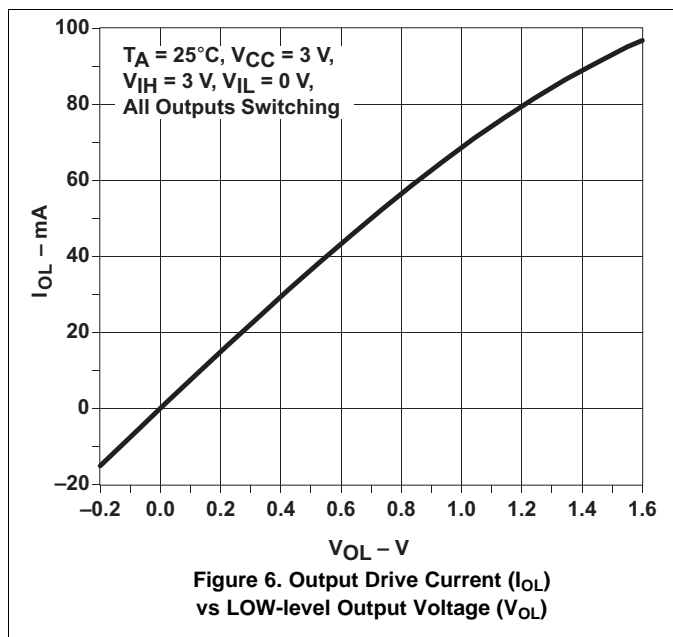

11 Power Supply Recommendations

The power supply can be any voltage between the minimum and maximum supply voltage rating located in the [Recommended Operating Conditions](#) table.

Each V_{CC} pin should have a good bypass capacitor to prevent power disturbance. For devices with a single supply, a 0.1- μF capacitor is recommended and if there are multiple V_{CC} pins then 0.01- μF or 0.022- μF capacitor is recommended for each power pin. It is ok to parallel multiple bypass capacitors to reject different frequencies of noise. 0.1- μF and 1- μF capacitors are commonly used in parallel. The bypass capacitor should be installed as close to the power pin as possible for best results.

12 Layout

12.1 Layout Guidelines

When using multiple bit logic devices inputs should not ever float. In many cases, functions or parts of functions of digital logic devices are unused; for example, when only two inputs of a triple-input AND gate are used or only 3 of the 4 buffer gates are used. Such input pins should not be left unconnected because the undefined voltages at the outside connections result in undefined operational states. Specified below are the rules that must be observed under all circumstances. All unused inputs of digital logic devices must be connected to a high or low bias to prevent them from floating. The logic level that should be applied to any particular unused input depends on the function of the device. Generally they will be tied to GND or V_{CC} whichever make more sense or is more convenient.

12.2 Layout Examples

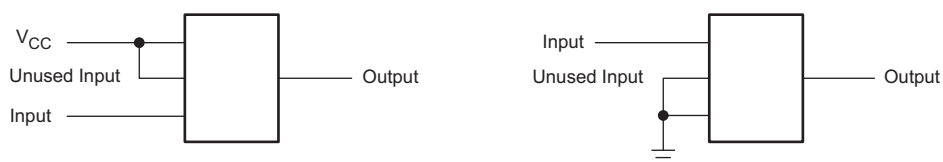

Figure 8. Layout Examples

13 Device and Documentation Support

13.1 Related Links

The table below lists quick access links. Categories include technical documents, support and community resources, tools and software, and quick access to sample or buy.

Table 2. Related Links

PARTS	PRODUCT FOLDER	SAMPLE & BUY	TECHNICAL DOCUMENTS	TOOLS & SOFTWARE	SUPPORT & COMMUNITY
SN54LVC08A	Click here	Click here	Click here	Click here	Click here
SN74LVC08A	Click here	Click here	Click here	Click here	Click here

13.2 Community Resources

The following links connect to TI community resources. Linked contents are provided "AS IS" by the respective contributors. They do not constitute TI specifications and do not necessarily reflect TI's views; see TI's [Terms of Use](#).

TI E2E™ Online Community *TI's Engineer-to-Engineer (E2E) Community*. Created to foster collaboration among engineers. At e2e.ti.com, you can ask questions, share knowledge, explore ideas and help solve problems with fellow engineers.

Design Support *TI's Design Support* Quickly find helpful E2E forums along with design support tools and contact information for technical support.

13.3 Trademarks

E2E is a trademark of Texas Instruments.
All other trademarks are the property of their respective owners.

13.4 Electrostatic Discharge Caution



These devices have limited built-in ESD protection. The leads should be shorted together or the device placed in conductive foam during storage or handling to prevent electrostatic damage to the MOS gates.

13.5 Glossary

SLYZ022 — *TI Glossary*.

This glossary lists and explains terms, acronyms, and definitions.

14 Mechanical, Packaging, and Orderable Information

The following pages include mechanical packaging and orderable information. This information is the most current data available for the designated devices. This data is subject to change without notice and revision of this document. For browser based versions of this data sheet, refer to the left hand navigation.

PACKAGING INFORMATION

Orderable Device	Status (1)	Package Type	Package Drawing	Pins	Package Qty	Eco Plan (2)	Lead/Ball Finish (6)	MSL Peak Temp (3)	Op Temp (°C)	Device Marking (4/5)	Samples
5962-9753401Q2A	ACTIVE	LCCC	FK	20	1	TBD	POST-PLATE	N / A for Pkg Type	-55 to 125	5962-9753401Q2A SNJ54LVC 08AFK	Samples
5962-9753401QCA	ACTIVE	CDIP	J	14	1	TBD	A42	N / A for Pkg Type	-55 to 125	5962-9753401QC A SNJ54LVC08AJ	Samples
5962-9753401QDA	ACTIVE	CFP	W	14	1	TBD	A42	N / A for Pkg Type	-55 to 125	5962-9753401QD A SNJ54LVC08AW	Samples
SN74LVC08AD	ACTIVE	SOIC	D	14	50	Green (RoHS & no Sb/Br)	CU NIPDAU	Level-1-260C-UNLIM	-40 to 125	LVC08A	Samples
SN74LVC08ADBR	ACTIVE	SSOP	DB	14	2000	Green (RoHS & no Sb/Br)	CU NIPDAU	Level-1-260C-UNLIM	-40 to 125	LC08A	Samples
SN74LVC08ADBRE4	ACTIVE	SSOP	DB	14	2000	Green (RoHS & no Sb/Br)	CU NIPDAU	Level-1-260C-UNLIM	-40 to 125	LC08A	Samples
SN74LVC08ADBRG4	ACTIVE	SSOP	DB	14	2000	Green (RoHS & no Sb/Br)	CU NIPDAU	Level-1-260C-UNLIM	-40 to 125	LC08A	Samples
SN74LVC08ADE4	ACTIVE	SOIC	D	14	50	Green (RoHS & no Sb/Br)	CU NIPDAU	Level-1-260C-UNLIM	-40 to 125	LVC08A	Samples
SN74LVC08ADG4	ACTIVE	SOIC	D	14	50	Green (RoHS & no Sb/Br)	CU NIPDAU	Level-1-260C-UNLIM	-40 to 125	LVC08A	Samples
SN74LVC08ADR	ACTIVE	SOIC	D	14	2500	Green (RoHS & no Sb/Br)	CU NIPDAU CU SN	Level-1-260C-UNLIM	-40 to 125	LVC08A	Samples
SN74LVC08ADRE4	ACTIVE	SOIC	D	14	2500	Green (RoHS & no Sb/Br)	CU NIPDAU	Level-1-260C-UNLIM	-40 to 125	LVC08A	Samples
SN74LVC08ADRG3	ACTIVE	SOIC	D	14	2500	Green (RoHS & no Sb/Br)	CU SN	Level-1-260C-UNLIM	-40 to 125	LVC08A	Samples
SN74LVC08ADRG4	ACTIVE	SOIC	D	14	2500	Green (RoHS & no Sb/Br)	CU NIPDAU	Level-1-260C-UNLIM	-40 to 125	LVC08A	Samples
SN74LVC08ADT	ACTIVE	SOIC	D	14	250	Green (RoHS & no Sb/Br)	CU NIPDAU	Level-1-260C-UNLIM	-40 to 125	LVC08A	Samples
SN74LVC08ANSR	ACTIVE	SO	NS	14	2000	Green (RoHS & no Sb/Br)	CU NIPDAU	Level-1-260C-UNLIM	-40 to 125	LVC08A	Samples

Orderable Device	Status (1)	Package Type	Package Drawing	Pins	Package Qty	Eco Plan (2)	Lead/Ball Finish (6)	MSL Peak Temp (3)	Op Temp (°C)	Device Marking (4/5)	Samples
SN74LVC08ANSRE4	ACTIVE	SO	NS	14	2000	Green (RoHS & no Sb/Br)	CU NIPDAU	Level-1-260C-UNLIM	-40 to 125	LVC08A	Samples
SN74LVC08APW	ACTIVE	TSSOP	PW	14	90	Green (RoHS & no Sb/Br)	CU NIPDAU	Level-1-260C-UNLIM	-40 to 125	LC08A	Samples
SN74LVC08APWG4	ACTIVE	TSSOP	PW	14	90	Green (RoHS & no Sb/Br)	CU NIPDAU	Level-1-260C-UNLIM	-40 to 125	LC08A	Samples
SN74LVC08APWR	ACTIVE	TSSOP	PW	14	2000	Green (RoHS & no Sb/Br)	CU NIPDAU CU SN	Level-1-260C-UNLIM	-40 to 125	LC08A	Samples
SN74LVC08APWRE4	ACTIVE	TSSOP	PW	14	2000	Green (RoHS & no Sb/Br)	CU NIPDAU	Level-1-260C-UNLIM	-40 to 125	LC08A	Samples
SN74LVC08APWRG3	ACTIVE	TSSOP	PW	14	2000	Green (RoHS & no Sb/Br)	CU SN	Level-1-260C-UNLIM	-40 to 125	LC08A	Samples
SN74LVC08APWRG4	ACTIVE	TSSOP	PW	14	2000	Green (RoHS & no Sb/Br)	CU NIPDAU	Level-1-260C-UNLIM	-40 to 125	LC08A	Samples
SN74LVC08APWT	ACTIVE	TSSOP	PW	14	250	Green (RoHS & no Sb/Br)	CU NIPDAU	Level-1-260C-UNLIM	-40 to 125	LC08A	Samples
SN74LVC08APWTG4	ACTIVE	TSSOP	PW	14	250	Green (RoHS & no Sb/Br)	CU NIPDAU	Level-1-260C-UNLIM	-40 to 125	LC08A	Samples
SN74LVC08ARGYR	ACTIVE	VQFN	RGY	14	3000	Green (RoHS & no Sb/Br)	CU NIPDAU	Level-2-260C-1 YEAR	-40 to 125	LC08A	Samples
SN74LVC08ARGYRG4	ACTIVE	VQFN	RGY	14	3000	Green (RoHS & no Sb/Br)	CU NIPDAU	Level-2-260C-1 YEAR	-40 to 125	LC08A	Samples
SNJ54LVC08AFK	ACTIVE	LCCC	FK	20	1	TBD	POST-PLATE	N / A for Pkg Type	-55 to 125	5962-9753401Q2A SNJ54LVC08AFK	Samples
SNJ54LVC08AJ	ACTIVE	CDIP	J	14	1	TBD	A42	N / A for Pkg Type	-55 to 125	5962-9753401QC A SNJ54LVC08AJ	Samples
SNJ54LVC08AW	ACTIVE	CFP	W	14	1	TBD	A42	N / A for Pkg Type	-55 to 125	5962-9753401QD A SNJ54LVC08AW	Samples

(1) The marketing status values are defined as follows:

ACTIVE: Product device recommended for new designs.

LIFEBUY: TI has announced that the device will be discontinued, and a lifetime-buy period is in effect.

NRND: Not recommended for new designs. Device is in production to support existing customers, but TI does not recommend using this part in a new design.

PREVIEW: Device has been announced but is not in production. Samples may or may not be available.

OBSOLETE: TI has discontinued the production of the device.

(2) **RoHS:** TI defines "RoHS" to mean semiconductor products that are compliant with the current EU RoHS requirements for all 10 RoHS substances, including the requirement that RoHS substance do not exceed 0.1% by weight in homogeneous materials. Where designed to be soldered at high temperatures, "RoHS" products are suitable for use in specified lead-free processes. TI may reference these types of products as "Pb-Free".

RoHS Exempt: TI defines "RoHS Exempt" to mean products that contain lead but are compliant with EU RoHS pursuant to a specific EU RoHS exemption.

Green: TI defines "Green" to mean the content of Chlorine (Cl) and Bromine (Br) based flame retardants meet JS709B low halogen requirements of <=1000ppm threshold. Antimony trioxide based flame retardants must also meet the <=1000ppm threshold requirement.

(3) **MSL, Peak Temp.** - The Moisture Sensitivity Level rating according to the JEDEC industry standard classifications, and peak solder temperature.

(4) There may be additional marking, which relates to the logo, the lot trace code information, or the environmental category on the device.

(5) Multiple Device Markings will be inside parentheses. Only one Device Marking contained in parentheses and separated by a "~" will appear on a device. If a line is indented then it is a continuation of the previous line and the two combined represent the entire Device Marking for that device.

(6) **Lead/Ball Finish** - Orderable Devices may have multiple material finish options. Finish options are separated by a vertical ruled line. Lead/Ball Finish values may wrap to two lines if the finish value exceeds the maximum column width.

Important Information and Disclaimer:The information provided on this page represents TI's knowledge and belief as of the date that it is provided. TI bases its knowledge and belief on information provided by third parties, and makes no representation or warranty as to the accuracy of such information. Efforts are underway to better integrate information from third parties. TI has taken and continues to take reasonable steps to provide representative and accurate information but may not have conducted destructive testing or chemical analysis on incoming materials and chemicals. TI and TI suppliers consider certain information to be proprietary, and thus CAS numbers and other limited information may not be available for release.

In no event shall TI's liability arising out of such information exceed the total purchase price of the TI part(s) at issue in this document sold by TI to Customer on an annual basis.

OTHER QUALIFIED VERSIONS OF SN54LVC08A, SN74LVC08A :

- Catalog: [SN74LVC08A](#)

- Automotive: [SN74LVC08A-Q1](#), [SN74LVC08A-Q1](#)

- Enhanced Product: [SN74LVC08A-EP](#), [SN74LVC08A-EP](#)

- Military: [SN54LVC08A](#)

NOTE: Qualified Version Definitions:

- Catalog - TI's standard catalog product
- Automotive - Q100 devices qualified for high-reliability automotive applications targeting zero defects
- Enhanced Product - Supports Defense, Aerospace and Medical Applications
- Military - QML certified for Military and Defense Applications

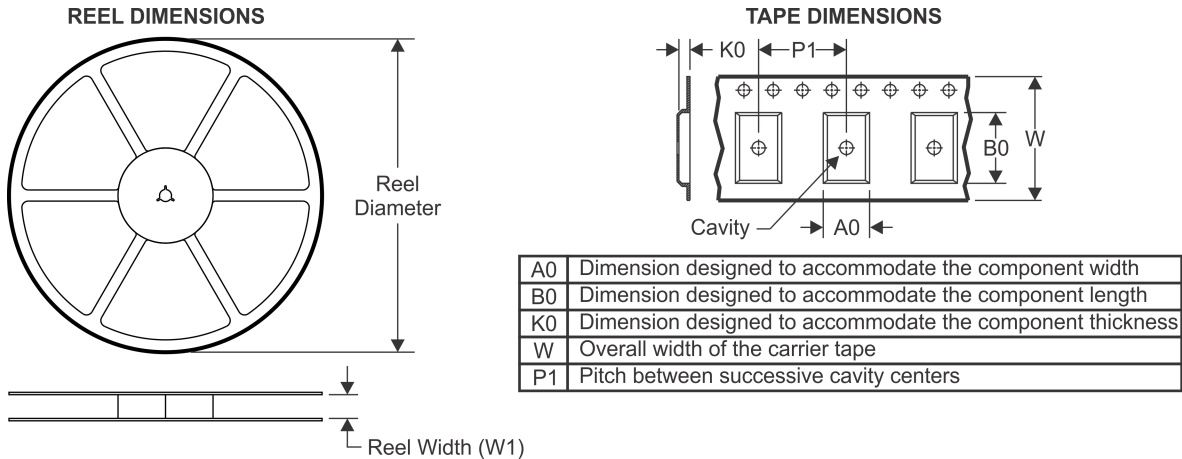
TAPE AND REEL INFORMATION

QUADRANT ASSIGNMENTS FOR PIN 1 ORIENTATION IN TAPE

*All dimensions are nominal

Device	Package Type	Package Drawing	Pins	SPQ	Reel Diameter (mm)	Reel Width W1 (mm)	A0 (mm)	B0 (mm)	K0 (mm)	P1 (mm)	W (mm)	Pin1 Quadrant
SN74LVC08ADR	SOIC	D	14	2500	330.0	16.4	6.5	9.0	2.1	8.0	16.0	Q1
SN74LVC08ADR	SOIC	D	14	2500	330.0	16.4	6.5	9.0	2.1	8.0	16.0	Q1
SN74LVC08ADR	SOIC	D	14	2500	330.0	16.8	6.5	9.5	2.1	8.0	16.0	Q1
SN74LVC08ADRG3	SOIC	D	14	2500	330.0	16.8	6.5	9.5	2.1	8.0	16.0	Q1
SN74LVC08ADRG4	SOIC	D	14	2500	330.0	16.4	6.5	9.0	2.1	8.0	16.0	Q1
SN74LVC08ADRG4	SOIC	D	14	2500	330.0	16.4	6.5	9.0	2.1	8.0	16.0	Q1
SN74LVC08ADT	SOIC	D	14	250	330.0	16.4	6.5	9.0	2.1	8.0	16.0	Q1
SN74LVC08ANSR	SO	NS	14	2000	330.0	16.4	8.2	10.5	2.5	12.0	16.0	Q1
SN74LVC08APWR	TSSOP	PW	14	2000	330.0	12.4	6.9	5.6	1.6	8.0	12.0	Q1
SN74LVC08APWRG3	TSSOP	PW	14	2000	330.0	12.4	6.9	5.6	1.6	8.0	12.0	Q1
SN74LVC08APWRG4	TSSOP	PW	14	2000	330.0	12.4	6.9	5.6	1.6	8.0	12.0	Q1
SN74LVC08APWT	TSSOP	PW	14	250	330.0	12.4	6.9	5.6	1.6	8.0	12.0	Q1
SN74LVC08ARGYR	VQFN	RGY	14	3000	330.0	12.4	3.75	3.75	1.15	8.0	12.0	Q1

TAPE AND REEL BOX DIMENSIONS



*All dimensions are nominal

Device	Package Type	Package Drawing	Pins	SPQ	Length (mm)	Width (mm)	Height (mm)
SN74LVC08ADR	SOIC	D	14	2500	333.2	345.9	28.6
SN74LVC08ADR	SOIC	D	14	2500	367.0	367.0	38.0
SN74LVC08ADR	SOIC	D	14	2500	364.0	364.0	27.0
SN74LVC08ADRG3	SOIC	D	14	2500	364.0	364.0	27.0
SN74LVC08ADRG4	SOIC	D	14	2500	333.2	345.9	28.6
SN74LVC08ADRG4	SOIC	D	14	2500	367.0	367.0	38.0
SN74LVC08ADT	SOIC	D	14	250	210.0	185.0	35.0
SN74LVC08ANSR	SO	NS	14	2000	367.0	367.0	38.0
SN74LVC08APWR	TSSOP	PW	14	2000	367.0	367.0	35.0
SN74LVC08APWRG3	TSSOP	PW	14	2000	364.0	364.0	27.0
SN74LVC08APWRG4	TSSOP	PW	14	2000	367.0	367.0	35.0
SN74LVC08APWT	TSSOP	PW	14	250	367.0	367.0	35.0
SN74LVC08ARGYR	VQFN	RGY	14	3000	367.0	367.0	35.0

FK (S-CQCC-N**)

LEADLESS CERAMIC CHIP CARRIER

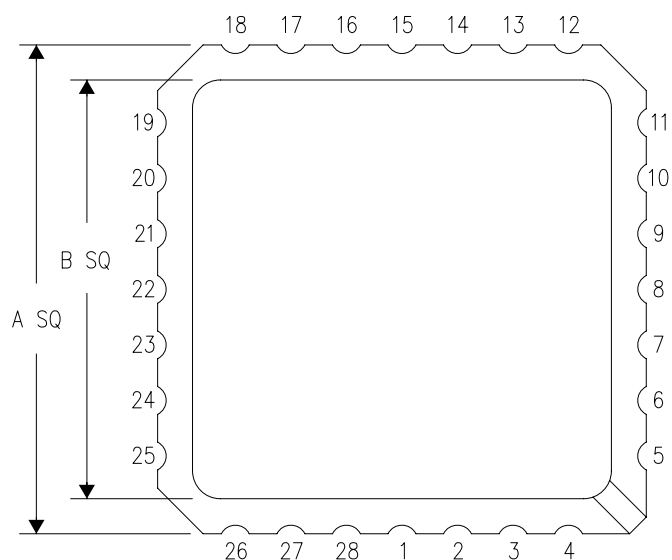
28 TERMINAL SHOWN



NO. OF TERMINALS **	A		B	
	MIN	MAX	MIN	MAX
20	0.342 (8,69)	0.358 (9,09)	0.307 (7,80)	0.358 (9,09)
28	0.442 (11,23)	0.458 (11,63)	0.406 (10,31)	0.458 (11,63)
44	0.640 (16,26)	0.660 (16,76)	0.495 (12,58)	0.560 (14,22)
52	0.740 (18,78)	0.761 (19,32)	0.495 (12,58)	0.560 (14,22)
68	0.938 (23,83)	0.962 (24,43)	0.850 (21,6)	0.858 (21,8)
84	1.141 (28,99)	1.165 (29,59)	1.047 (26,6)	1.063 (27,0)

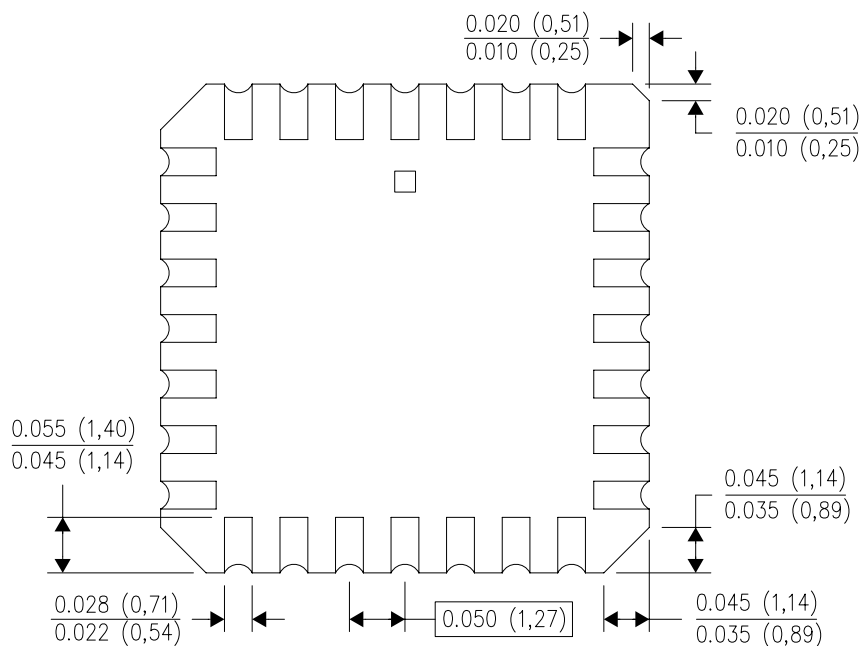

4040140/D 01/11

- NOTES:
- All linear dimensions are in inches (millimeters).
 - This drawing is subject to change without notice.
 - This package can be hermetically sealed with a metal lid.
 - Falls within JEDEC MS-004

RGY (S-PVQFN-N14)

PLASTIC QUAD FLATPACK NO-LEAD



- NOTES:
- A. All linear dimensions are in millimeters. Dimensioning and tolerancing per ASME Y14.5M-1994.
 - B. This drawing is subject to change without notice.
 - C. QFN (Quad Flatpack No-Lead) package configuration.
 - D. The package thermal pad must be soldered to the board for thermal and mechanical performance.
 - E. See the additional figure in the Product Data Sheet for details regarding the exposed thermal pad features and dimensions.
 -  Pin 1 identifiers are located on both top and bottom of the package and within the zone indicated. The Pin 1 identifiers are either a molded, marked, or metal feature.
 - G. Package complies to JEDEC MO-241 variation BA.

RGY (S-PVQFN-N14)

PLASTIC QUAD FLATPACK NO-LEAD

THERMAL INFORMATION

This package incorporates an exposed thermal pad that is designed to be attached directly to an external heatsink. The thermal pad must be soldered directly to the printed circuit board (PCB). After soldering, the PCB can be used as a heatsink. In addition, through the use of thermal vias, the thermal pad can be attached directly to the appropriate copper plane shown in the electrical schematic for the device, or alternatively, can be attached to a special heatsink structure designed into the PCB. This design optimizes the heat transfer from the integrated circuit (IC).

For information on the Quad Flatpack No-Lead (QFN) package and its advantages, refer to Application Report, QFN/SON PCB Attachment, Texas Instruments Literature No. SLUA271. This document is available at www.ti.com.

The exposed thermal pad dimensions for this package are shown in the following illustration.

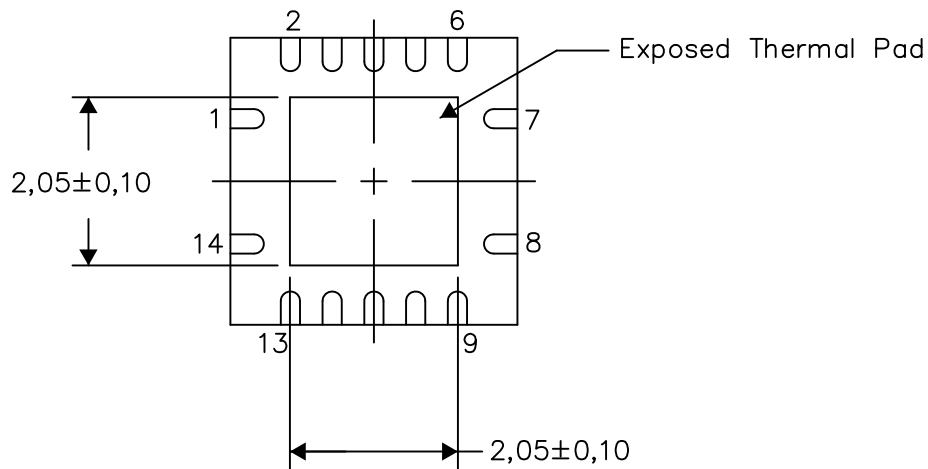

Bottom View

Exposed Thermal Pad Dimensions

4206353-2/P 03/14

NOTE: All linear dimensions are in millimeters

RGY (S-PVQFN-N14)

PLASTIC QUAD FLATPACK NO-LEAD



4208122-2/P 03/14

- NOTES:
- All linear dimensions are in millimeters.
 - This drawing is subject to change without notice.
 - Publication IPC-7351 is recommended for alternate designs.
 - This package is designed to be soldered to a thermal pad on the board. Refer to Application Note, Quad Flat-Pack QFN/SON PCB Attachment, Texas Instruments Literature No. SLUA271, and also the Product Data Sheets for specific thermal information, via requirements, and recommended board layout. These documents are available at www.ti.com <<http://www.ti.com>>.
 - Laser cutting apertures with trapezoidal walls and also rounding corners will offer better paste release. Customers should contact their board assembly site for stencil design recommendations. Refer to IPC 7525 for stencil design considerations.
 - Customers should contact their board fabrication site for minimum solder mask web tolerances between signal pads.

MECHANICAL DATA

NS (R-PDSO-G**)

PLASTIC SMALL-OUTLINE PACKAGE

14-PINS SHOWN



- NOTES:
- All linear dimensions are in millimeters.
 - This drawing is subject to change without notice.
 - Body dimensions do not include mold flash or protrusion, not to exceed 0,15.

W (R-GDFP-F14)

CERAMIC DUAL FLATPACK



4040180-2/F 04/14

- NOTES:
- A. All linear dimensions are in inches (millimeters).
 - B. This drawing is subject to change without notice.
 - C. This package can be hermetically sealed with a ceramic lid using glass frit.
 - D. Index point is provided on cap for terminal identification only.
 - E. Falls within MIL STD 1835 GDFP1-F14

J 14

GENERIC PACKAGE VIEW
CDIP - 5.08 mm max height
CERAMIC DUAL IN LINE PACKAGE



Images above are just a representation of the package family, actual package may vary.
Refer to the product data sheet for package details.

4040083-5/G

J0014A



PACKAGE OUTLINE

CDIP - 5.08 mm max height

CERAMIC DUAL IN LINE PACKAGE



4214771/A 05/2017

NOTES:

1. All controlling linear dimensions are in inches. Dimensions in brackets are in millimeters. Any dimension in brackets or parenthesis are for reference only. Dimensioning and tolerancing per ASME Y14.5M.
2. This drawing is subject to change without notice.
3. This package is hermetically sealed with a ceramic lid using glass frit.
4. Index point is provided on cap for terminal identification only and on press ceramic glass frit seal only.
5. Falls within MIL-STD-1835 and GDIP1-T14.

EXAMPLE BOARD LAYOUT

J0014A

CDIP - 5.08 mm max height

CERAMIC DUAL IN LINE PACKAGE



LAND PATTERN EXAMPLE
NON-SOLDER MASK DEFINED
SCALE: 5X



4214771/A 05/2017

D (R-PDSO-G14)

PLASTIC SMALL OUTLINE



- NOTES:
- A. All linear dimensions are in inches (millimeters).
 - B. This drawing is subject to change without notice.
 -  Body length does not include mold flash, protrusions, or gate burrs. Mold flash, protrusions, or gate burrs shall not exceed 0.006 (0,15) each side.
 -  Body width does not include interlead flash. Interlead flash shall not exceed 0.017 (0,43) each side.
 - E. Reference JEDEC MS-012 variation AB.

D (R-PDSO-G14)

PLASTIC SMALL OUTLINE



4211283-3/E 08/12

- NOTES:
- All linear dimensions are in millimeters.
 - This drawing is subject to change without notice.
 - Publication IPC-7351 is recommended for alternate designs.
 - Laser cutting apertures with trapezoidal walls and also rounding corners will offer better paste release. Customers should contact their board assembly site for stencil design recommendations. Refer to IPC-7525 for other stencil recommendations.
 - Customers should contact their board fabrication site for solder mask tolerances between and around signal pads.

PW (R-PDSO-G14)

PLASTIC SMALL OUTLINE

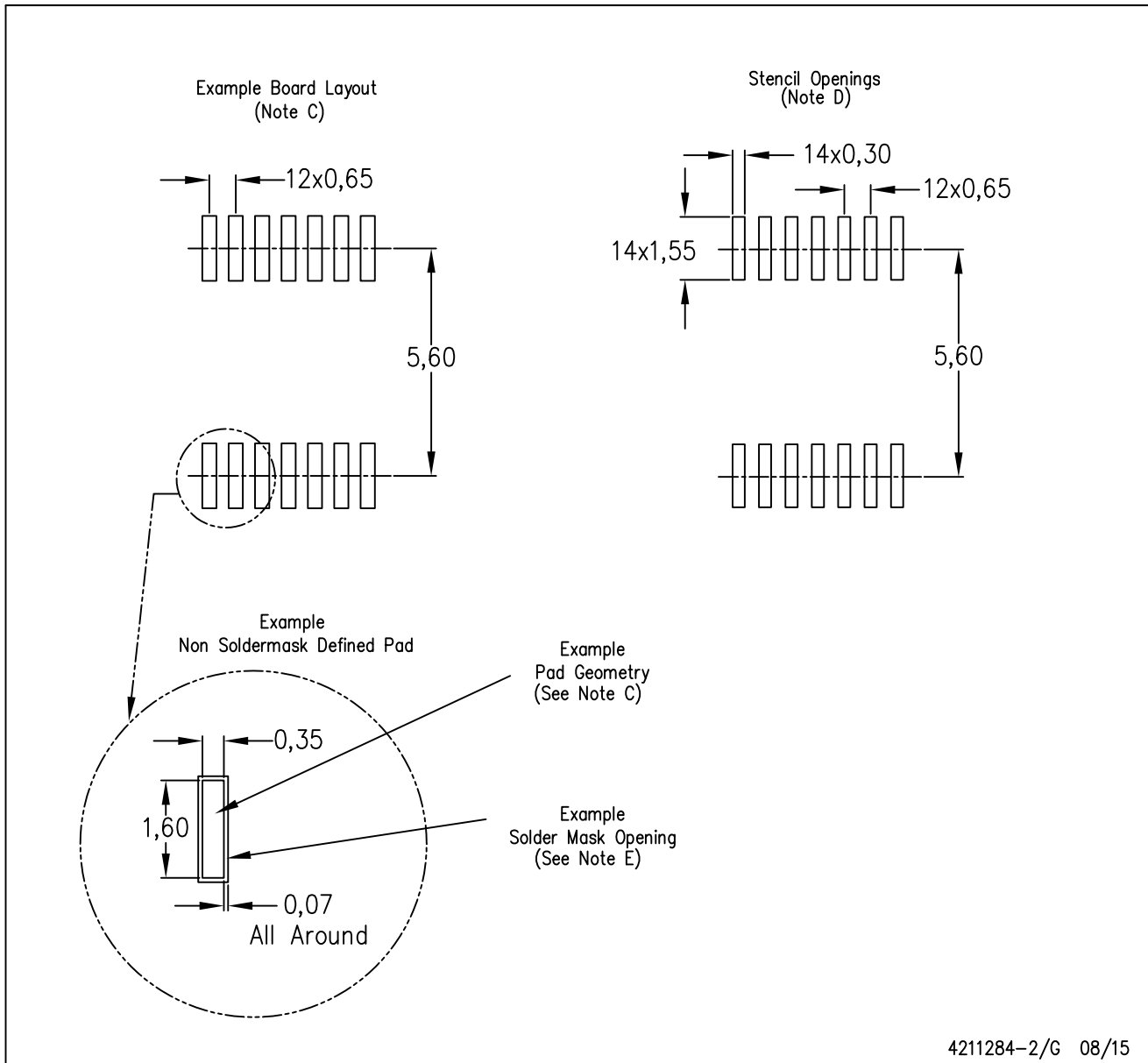

4211284-2/G 08/15

- NOTES:
- All linear dimensions are in millimeters.
 - This drawing is subject to change without notice.
 - Publication IPC-7351 is recommended for alternate designs.
 - Laser cutting apertures with trapezoidal walls and also rounding corners will offer better paste release. Customers should contact their board assembly site for stencil design recommendations. Refer to IPC-7525 for other stencil recommendations.
 - Customers should contact their board fabrication site for solder mask tolerances between and around signal pads.

IMPORTANT NOTICE AND DISCLAIMER

TI PROVIDES TECHNICAL AND RELIABILITY DATA (INCLUDING DATASHEETS), DESIGN RESOURCES (INCLUDING REFERENCE DESIGNS), APPLICATION OR OTHER DESIGN ADVICE, WEB TOOLS, SAFETY INFORMATION, AND OTHER RESOURCES "AS IS" AND WITH ALL FAULTS, AND DISCLAIMS ALL WARRANTIES, EXPRESS AND IMPLIED, INCLUDING WITHOUT LIMITATION ANY IMPLIED WARRANTIES OF MERCHANTABILITY, FITNESS FOR A PARTICULAR PURPOSE OR NON-INFRINGEMENT OF THIRD PARTY INTELLECTUAL PROPERTY RIGHTS.

These resources are intended for skilled developers designing with TI products. You are solely responsible for (1) selecting the appropriate TI products for your application, (2) designing, validating and testing your application, and (3) ensuring your application meets applicable standards, and any other safety, security, or other requirements. These resources are subject to change without notice. TI grants you permission to use these resources only for development of an application that uses the TI products described in the resource. Other reproduction and display of these resources is prohibited. No license is granted to any other TI intellectual property right or to any third party intellectual property right. TI disclaims responsibility for, and you will fully indemnify TI and its representatives against, any claims, damages, costs, losses, and liabilities arising out of your use of these resources.

TI's products are provided subject to TI's Terms of Sale (www.ti.com/legal/termsofsale.html) or other applicable terms available either on ti.com or provided in conjunction with such TI products. TI's provision of these resources does not expand or otherwise alter TI's applicable warranties or warranty disclaimers for TI products.

Mailing Address: Texas Instruments, Post Office Box 655303, Dallas, Texas 75265
Copyright © 2019, Texas Instruments Incorporated

Looking for pricing, stock, or lifecycle information?

Click below to explore more details on WIN SOURCE:

 [View SN74LVC08AD](#) on WIN SOURCE

 [Texas Instruments](#) Information

Optimize Your Supply Chain with WIN SOURCE Solutions

-  Global Sourcing Solution
-  Obsolete Management
-  Cost Control Management
-  Shortage Management
-  Alternative Solution
-  Excess Inventory Management