



**THE DATASHEET OF
SN74AVC16T245DGVR**



SN74AVC16T245 16-Bit Dual-Supply Bus Transceiver with Configurable Level-Shifting / Voltage Translation and Tri-State Outputs

1 Features

- Control Inputs V_{IH}/V_{IL} Levels Are Referenced to V_{CCA} Voltage
- V_{CC} Isolation Feature – If Either V_{CC} Input Is at GND, Both Ports Are in the High-Impedance State
- Overvoltage-Tolerant Inputs and Outputs Allow Mixed-Voltage-Mode Data Communications
- Fully Configurable Dual-Rail Design Allows Each Port to Operate Over the Full 1.2 V to 3.6 V Power-Supply Range
- I_{off} Supports Partial-Power-Down Mode Operation
- I/Os Are 4.6 V Tolerant
- Maximum Data Rates
 - 380 Mbps (1.8 V to 3.3 V Level-Shifting)
 - 200 Mbps (<1.8 V to 3.3 V Level-Shifting)
 - 200 Mbps (Level-Shifting to 2.5 V or 1.8 V)
 - 150 Mbps (Level-Shifting to 1.5 V)
 - 100 Mbps (Level-Shifting to 1.2 V)
- Latch-Up Performance Exceeds 100 mA Per JESD 78, Class II
- ESD Protection Exceeds JESD 22
 - 8000-V Human-Body Model (A114-A)
 - 200-V Machine Model (A115-A)
 - 1000-V Charged-Device Model (C101)

2 Applications

- Personal Electronics
- Industrial
- Enterprise
- Telecom

3 Description

This 16-bit noninverting bus transceiver uses two separate configurable power-supply rails. The SN74AVC16T245 device is optimized to operate with V_{CCA}/V_{CCB} set at 1.4 V to 3.6 V. The device is operational with V_{CCA}/V_{CCB} as low as 1.2 V. The A port is designed to track V_{CCA} . V_{CCA} accepts any supply voltage from 1.2 V to 3.6 V. The B port is designed to track V_{CCB} . V_{CCB} accepts any supply voltage from 1.2 V to 3.6 V. This allows for universal low-voltage bidirectional translation between any of the 1.2-V, 1.5-V, 1.8-V, 2.5-V, and 3.3-V voltage nodes.

The SN74AVC16T245 device is designed for asynchronous communication between data buses. The device transmits data from the A bus to the B bus or from the B bus to the A bus, depending on the logic level at the direction-control (DIR) input. The output-enable (\overline{OE}) input can be used to disable the outputs so the buses effectively are isolated.

The SN74AVC16T245 control pins (1DIR, 2DIR, $1\overline{OE}$, and $2\overline{OE}$) are supplied by V_{CCA} .

Device Information⁽¹⁾

PART NUMBER	PACKAGE	BODY SIZE (NOM)
SN74AVC16T245	TSSOP (48)	12.50 mm x 6.10 mm
	TVSOP (48)	9.70 mm x 4.40 mm
	BGA MICROSTAR JUNIOR (56)	7.00 mm x 4.50 mm

(1) For all available packages, see the orderable addendum at the end of the data sheet.

Logic Diagram (Positive Logic)

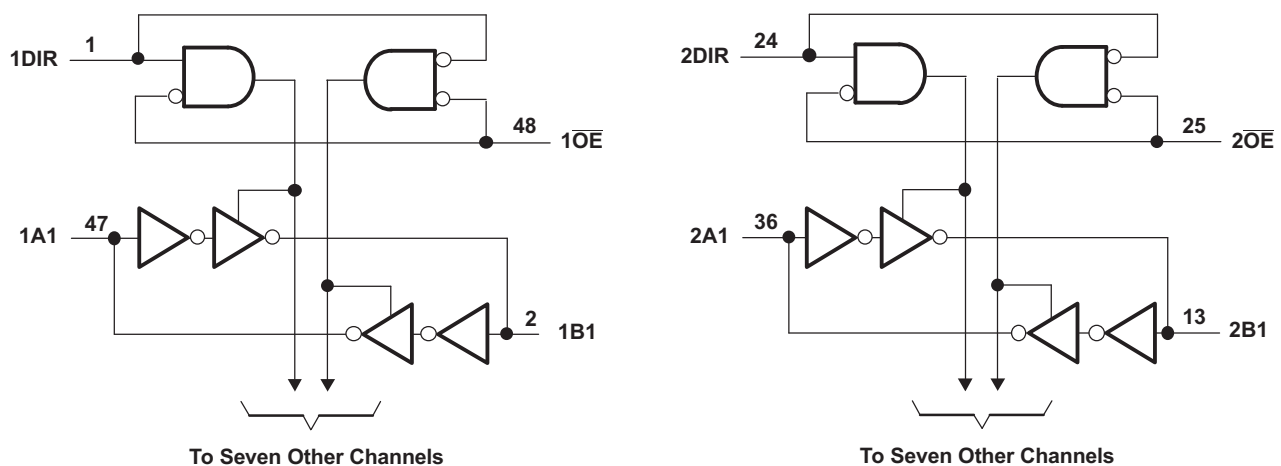

Table of Contents

1 Features	1	9 Detailed Description	13
2 Applications	1	9.1 Overview	13
3 Description	1	9.2 Functional Block Diagram	13
4 Revision History	2	9.3 Feature Description	13
5 Description (continued)	3	9.4 Device Functional Modes	14
6 Pin Configuration and Functions	4	10 Application and Implementation	15
7 Specifications	5	10.1 Application Information	15
7.1 Absolute Maximum Ratings	5	10.2 Typical Application	16
7.2 ESD Ratings	5	11 Power Supply Recommendations	18
7.3 Recommended Operating Conditions	6	12 Layout	18
7.4 Thermal Information	6	12.1 Layout Guidelines	18
7.5 Electrical Characteristics	7	12.2 Layout Example	19
7.6 Switching Characteristics: $V_{CCA} = 1.2\text{ V}$	8	13 Device and Documentation Support	20
7.7 Switching Characteristics: $V_{CCA} = 1.5\text{ V} \pm 0.1\text{ V}$	8	13.1 Documentation Support	20
7.8 Switching Characteristics: $V_{CCA} = 1.8\text{ V} \pm 0.15\text{ V}$	8	13.2 Community Resources	20
7.9 Switching Characteristics: $V_{CCA} = 2.5\text{ V} \pm 0.2\text{ V}$	9	13.3 Trademarks	20
7.10 Switching Characteristics: $V_{CCA} = 3.3\text{ V} \pm 0.3\text{ V}$	9	13.4 Electrostatic Discharge Caution	20
7.11 Operating Characteristics	9	13.5 Glossary	20
7.12 Typical Characteristics	10	14 Mechanical, Packaging, and Orderable Information	20
8 Parameter Measurement Information	12		

4 Revision History

NOTE: Page numbers for previous revisions may differ from page numbers in the current version.

Changes from Revision D (February 2015) to Revision E	Page
• Updated Pin Functions Table.	4

Changes from Revision C (August 2005) to Revision D	Page
• Added <i>ESD Ratings</i> table, <i>Feature Description</i> section, <i>Device Functional Modes</i> , <i>Application and Implementation</i> section, <i>Power Supply Recommendations</i> section, <i>Layout</i> section, <i>Device and Documentation Support</i> section, and <i>Mechanical, Packaging, and Orderable Information</i> section	1

5 Description (continued)

This device is fully specified for partial-power-down applications using I_{off} . The I_{off} circuitry disables the outputs, preventing damaging current backflow through the device when it is powered down.

The V_{CC} isolation feature ensures that if either V_{CC} input is at GND, both ports are in the high-impedance state.

To ensure the high-impedance state during power up or power down, \overline{OE} should be tied to V_{CCA} through a pullup resistor; the minimum value of the resistor is determined by the current-sinking capability of the driver.

6 Pin Configuration and Functions

GQL or ZQL Package
56-Pin BGA MICROSTAR JUNIOR
Top View

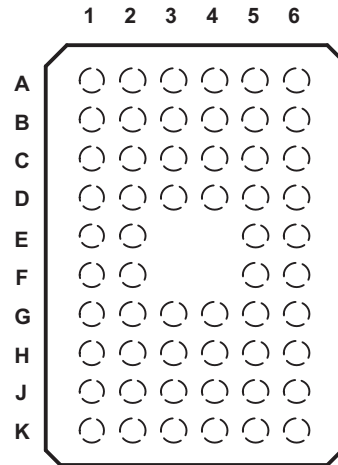

DGG or DGV Package
48-Pin TSSOP or TVSOP
Top View

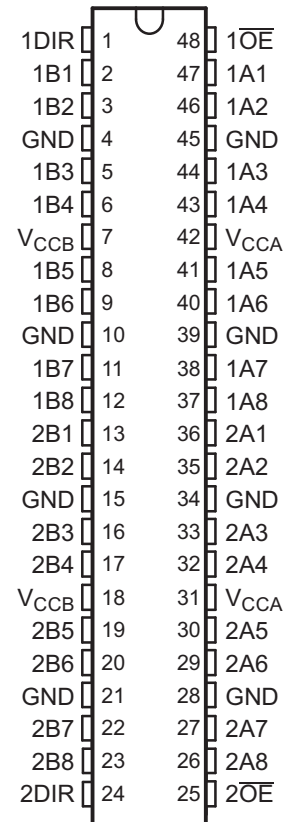

Pin Functions

PIN		I/O	DESCRIPTION	
NAME	TSSOP, TVSOP			BGA MICROSTAR
1DIR, 2DIR	1, 24	A1, K1	I	Direction-control signal
1B1 to 1B8	2, 3, 5, 6, 8, 9, 11, 12	B2, B1, C2, C1, D2, D1, E2, E1	I/O	Input/Output. Referenced to V_{CCB}
2B1 to 2B8	13, 14, 16, 17, 19, 20, 22, 23	F1, F2, G1, G2, H1, H2, J1, J2	I/O	Input/Output. Referenced to V_{CCB}
GND	4, 10, 15, 21, 45, 39, 34, 28	B3, D3, G3, J3, J4, G4, D4, B4	—	Ground
V_{CCB}	7, 18	C3, H3	—	B-port supply voltage. $1.2\text{ V} \leq V_{CCB} \leq 3.6\text{ V}$
$1\overline{OE}$, $2\overline{OE}$	48, 25	A6, K6	—	Tri-State output-mode enables. Pull \overline{OE} high to place all outputs in Tri-State mode. Referenced to V_{CCA}
1A1 to 1A8	47, 46, 44, 43, 41, 40, 38, 37	B5, B6, C5, C6, D5, D6, E5, E6	I/O	Input/Output. Referenced to V_{CCA}
2A1 to 2A8	36, 35, 33, 32, 30, 29, 27, 26	F6, F5, G6, G5, H6, H5, J6, J5	I/O	Input/Output. Referenced to V_{CCA}
V_{CCA}	42, 31	C4, H4	—	A-port supply voltage. $1.2\text{ V} \leq V_{CCB} \leq 3.6\text{ V}$
N.C.	—	A2, A3, A4, A5, K2, K3, K4, K5	—	No internal connection

7 Specifications

7.1 Absolute Maximum Ratings

over operating free-air temperature range (unless otherwise noted)⁽¹⁾

		MIN	MAX	UNIT	
V_{CCA} V_{CCB}	Supply voltage	–0.5	4.6	V	
V_I	Input voltage ⁽²⁾	I/O ports (A port)	–0.5	4.6	V
		I/O ports (B port)	–0.5	4.6	
		Control inputs	–0.5	4.6	
V_O	Voltage range applied to any output in the high-impedance or power-off state ⁽²⁾	A port	–0.5	4.6	V
		B port	–0.5	4.6	
V_O	Voltage range applied to any output in the high or low state ⁽²⁾⁽³⁾	A port	–0.5	$V_{CCA} + 0.5$	V
		B port	–0.5	$V_{CCB} + 0.5$	
I_{IK}	Input clamp current	$V_I < 0$	–50	mA	
I_{OK}	Output clamp current	$V_O < 0$	–50	mA	
I_O	Continuous output current		±50	mA	
		Continuous current through each V_{CCA} , V_{CCB} , and GND	±100	mA	
$R_{\theta JA}$	Package thermal impedance ⁽⁴⁾	DGG package	70	°C/W	
		DGV package	58		
		GQL/ZQL package	42		
T_J	Junction temperature	–40	150	°C	
T_{stg}	Storage temperature	–65	150	°C	

- (1) Stresses beyond those listed under *Absolute Maximum Ratings* may cause permanent damage to the device. These are stress ratings only, which do not imply functional operation of the device at these or any other conditions beyond those indicated under *Recommended Operating Conditions*. Exposure to absolute-maximum-rated conditions for extended periods may affect device reliability.
- (2) The input voltage (V_I) and output negative-voltage (V_O) ratings may be exceeded if the input and output current ratings are observed.
- (3) The output positive-voltage rating may be exceeded up to 4.6 V maximum if the output current rating is observed.
- (4) The package thermal impedance is calculated in accordance with JESD 51-7.

7.2 ESD Ratings

		VALUE	UNIT	
$V_{(ESD)}$	Electrostatic discharge	Human-body model (HBM), per ANSI/ESDA/JEDEC JS-001 ⁽¹⁾	±8000	V
		Charged-device model (CDM), per JEDEC specification JESD22-C101 ⁽²⁾	±1000	
		Machine model (A115-A)	±200	

- (1) JEDEC document JEP155 states that 500-V HBM allows safe manufacturing with a standard ESD control process. Manufacturing with less than 500-V HBM is possible with the necessary precautions.
- (2) JEDEC document JEP157 states that 250-V CDM allows safe manufacturing with a standard ESD control process. Manufacturing with less than 250-V CDM is possible with the necessary precautions.

7.3 Recommended Operating Conditions

 over operating free-air temperature range (unless otherwise noted)⁽¹⁾⁽²⁾⁽³⁾

		V_{CCI}	V_{CCO}	MIN	MAX	UNIT
V_{CCA}	Supply voltage			1.2	3.6	V
V_{CCB}	Supply voltage			1.2	3.6	V
V_{IH}	High-level input voltage	Data inputs ⁽⁴⁾	1.2 V to 1.95 V	$V_{CCI} \times 0.65$		V
			1.95 V to 2.7 V	1.6		
			2.7 V to 3.6 V	2		
V_{IL}	Low-level input voltage	Data inputs ⁽⁴⁾	1.2 V to 1.95 V	$V_{CCI} \times 0.35$		V
			1.95 V to 2.7 V	0.7		
			2.7 V to 3.6 V	0.8		
V_{IH}	High-level input voltage	DIR (referenced to V_{CCA}) ⁽⁵⁾	1.2 V to 1.95 V	$V_{CCA} \times 0.65$		V
			1.95 V to 2.7 V	1.6		
			2.7 V to 3.6 V	2		
V_{IL}	Low-level input voltage	DIR (referenced to V_{CCA}) ⁽⁵⁾	1.2 V to 1.95 V	$V_{CCA} \times 0.35$		V
			1.95 V to 2.7 V	0.7		
			2.7 V to 3.6 V	0.8		
V_I	Input voltage			0	3.6	V
V_O	Output voltage	Active state		0	V_{CCO}	V
		Tri-State		0	3.6	
I_{OH}	High-level output current		1.2 V	-3		mA
			1.4 V to 1.6 V	-6		
			1.65 V to 1.95 V	-8		
			2.3 V to 2.7 V	-9		
			3 V to 3.6 V	-12		
I_{OL}	Low-level output current		1.2 V	3		mA
			1.4 V to 1.6 V	6		
			1.65 V to 1.95 V	8		
			2.3 V to 2.7 V	9		
			3 V to 3.6 V	12		
$\Delta t/\Delta v$	Input transition rise or fall rate				5	ns/V
T_A	Operating free-air temperature			-40	85	°C

 (1) V_{CCI} is the V_{CC} associated with the data input port.

 (2) V_{CCO} is the V_{CC} associated with the output port.

 (3) All unused data inputs of the device must be held at V_{CCI} or GND to ensure proper device operation. Refer to the TI application report, *Implications of Slow or Floating CMOS Inputs*, [SCBA004](#).

 (4) For V_{CCI} values not specified in the data sheet, V_{IH} min = $V_{CCI} \times 0.7$ V, V_{IL} max = $V_{CCI} \times 0.3$ V.

 (5) For V_{CCA} values not specified in the data sheet, V_{IH} min = $V_{CCA} \times 0.7$ V, V_{IL} max = $V_{CCA} \times 0.3$ V.

7.4 Thermal Information

THERMAL METRIC ⁽¹⁾	SN74AVC16T245			UNIT	
	DGV (TVSOP)	DGG (TSSOP)	ZQL (BGA MICROSTAR JUNIOR)		
	48 PINS	48 PINS	56 PINS		
$R_{\theta JA}$	Junction-to-ambient thermal resistance	82.5	69.9	64.6	°C/W
$R_{\theta JC(top)}$	Junction-to-case (top) thermal resistance	34.2	23.9	16.6	°C/W
$R_{\theta JB}$	Junction-to-board thermal resistance	45.1	36.6	30.8	°C/W
Ψ_{JT}	Junction-to-top characterization parameter	2.7	1.7	0.9	°C/W
Ψ_{JB}	Junction-to-board characterization parameter	44.6	36.2	64.6	°C/W

 (1) For more information about traditional and new thermal metrics, see the *Semiconductor and IC Package Thermal Metrics* application report, [SPRA953](#).

7.5 Electrical Characteristics

 over recommended operating free-air temperature range (unless otherwise noted)⁽¹⁾⁽²⁾

PARAMETER	TEST CONDITIONS		V _{CCA}	V _{CCB}	T _A = 25°C			T _A = -40°C to 85°C			UNIT	
					MIN	TYP	MAX	MIN	TYP	MAX		
V _{OH}		V _I = V _{IH}	1.2 V to 3.6 V	1.2 V to 3.6 V				V _{CCO} - 0.2			V	
					i _{OH} = -100 μA	0.95						
					i _{OH} = -3 mA							
					i _{OH} = -6 mA				1.05			
					i _{OH} = -8 mA				1.2			
					i _{OH} = -9 mA				1.75			
V _{OL}		V _I = V _{IL}	1.2 V to 3.6 V	1.2 V to 3.6 V				0.2			V	
					i _{OL} = 100 μA	0.15						
					i _{OL} = 3 mA							
					i _{OL} = 6 mA				0.35			
					i _{OL} = 8 mA				0.45			
					i _{OL} = 9 mA				0.55			
I _I	Control inputs	V _I = V _{CCA} or GND	1.2 V to 3.6 V	1.2 V to 3.6 V	±0.025 ±0.25					±1 μA		
I _{off}	A or B port	V _I or V _O = 0 to 3.6 V	0 V	0 to 3.6 V	±0.1 ±2.5					±5 μA		
	A or B port		0 to 3.6 V	0 V	±0.5 ±2.5							
I _{OZ} ⁽³⁾	A or B port	V _O = V _{CCO} or GND, V _I = V _{CCI} or GND, OE = V _{IH}	3.6 V	3.6 V	±0.5 ±2.5					±5 μA		
I _{CCA}		V _I = V _{CCI} or GND, I _O = 0	1.2 V to 3.6 V	1.2 V to 3.6 V				25			μA	
			0 V	3.6 V				-5				
			3.6 V	0 V				25				
I _{CCB}		V _I = V _{CCI} or GND, I _O = 0	1.2 V to 3.6 V	1.2 V to 3.6 V				25			μA	
			0 V	3.6 V				25				
			3.6 V	0 V				-5				
I _{CCA} + I _{CCB}		V _I = V _{CCI} or GND, I _O = 0	1.2 V to 3.6 V	1.2 V to 3.6 V				45			μA	
C _i	Control inputs	V _I = 3.3 V or GND	3.3 V	3.3 V	3.5					pF		
C _{io}	A or B port	V _O = 3.3 V or GND	3.3 V	3.3 V	7					pF		

(1) V_{CCO} is the V_{CC} associated with the output port.

(2) V_{CCI} is the V_{CC} associated with the input port.

(3) For I/O ports, the parameter I_{OZ} includes the input leakage current.

7.6 Switching Characteristics: $V_{CCA} = 1.2\text{ V}$

 over recommended operating free-air temperature range, $V_{CCA} = 1.2\text{ V}$ (see [Figure 11](#))

PARAMETER	FROM (INPUT)	TO (OUTPUT)	$V_{CCB} = 1.2\text{ V}$			$V_{CCB} = 1.5\text{ V}$			$V_{CCB} = 1.8\text{ V}$			$V_{CCB} = 2.5\text{ V}$			$V_{CCB} = 3.3\text{ V}$			UNIT
			MIN	TYP	MAX	MIN	TYP	MAX	MIN	TYP	MAX	MIN	TYP	MAX	MIN	TYP	MAX	
t_{PLH}	A	B	4.1			3.3			3			2.8			3.2			ns
t_{PHL}			4.1			3.3			3			2.8			3.2			
t_{PLH}	B	A	4.4			4			3.8			3.6			3.5			ns
t_{PHL}			4.4			4			3.8			3.6			3.5			
t_{PZH}	\overline{OE}	A	6.4			6.4			6.4			6.4			6.4			ns
t_{PZL}			6.4			6.4			6.4			6.4			6.4			
t_{PZH}	\overline{OE}	B	6			4.6			4			3.4			3.2			ns
t_{PZL}			6			4.6			4			3.4			3.2			
t_{PHZ}	\overline{OE}	A	6.6			6.6			6.6			6.6			6.8			ns
t_{PLZ}			6.6			6.6			6.6			6.6			6.8			
t_{PHZ}	\overline{OE}	B	6			4.9			4.9			4.2			5.3			ns
t_{PLZ}			6			4.9			4.9			4.2			5.3			

7.7 Switching Characteristics: $V_{CCA} = 1.5\text{ V} \pm 0.1\text{ V}$

 over recommended operating free-air temperature range, $V_{CCA} = 1.5\text{ V} \pm 0.1\text{ V}$ (see [Figure 11](#))

PARAMETER	FROM (INPUT)	TO (OUTPUT)	$V_{CCB} = 1.2\text{ V}$			$V_{CCB} = 1.5\text{ V} \pm 0.1\text{ V}$			$V_{CCB} = 1.8\text{ V} \pm 0.15\text{ V}$			$V_{CCB} = 2.5\text{ V} \pm 0.2\text{ V}$			$V_{CCB} = 3.3\text{ V} \pm 0.3\text{ V}$			UNIT												
			MIN	TYP	MAX	MIN	TYP	MAX	MIN	TYP	MAX	MIN	TYP	MAX	MIN	TYP	MAX													
t_{PLH}	A	B	3.6			0.5			6.2			0.5			5.2			0.5			4.1			0.5			3.7			ns
t_{PHL}			3.6			0.5			6.2			0.5			5.2			0.5			4.1			0.5			3.7			
t_{PLH}	B	A	3.3			0.5			6.2			0.5			5.9			0.5			5.6			0.5			5.5			ns
t_{PHL}			3.3			0.5			6.2			0.5			5.9			0.5			5.6			0.5			5.5			
t_{PZH}	\overline{OE}	A	4.3			1			10.1			1			10.1			1			10.1			1			10.1			ns
t_{PZL}			4.3			1			10.1			1			10.1			1			10.1			1			10.1			
t_{PZH}	\overline{OE}	B	5.6			1			10.1			0.5			8.1			0.5			5.9			0.5			5.2			ns
t_{PZL}			5.6			1			10.1			0.5			8.1			0.5			5.9			0.5			5.2			
t_{PHZ}	\overline{OE}	A	4.5			1.5			9.1			1.5			9.1			1.5			9.1			1.5			9.1			ns
t_{PLZ}			4.5			1.5			9.1			1.5			9.1			1.5			9.1			1.5			9.1			
t_{PHZ}	\overline{OE}	B	5.5			1.5			8.7			1.5			7.5			1			6.5			1			6.3			ns
t_{PLZ}			5.5			1.5			8.7			1.5			7.5			1			6.5			1			6.3			

7.8 Switching Characteristics: $V_{CCA} = 1.8\text{ V} \pm 0.15\text{ V}$

 over recommended operating free-air temperature range, $V_{CCA} = 1.8\text{ V} \pm 0.15\text{ V}$ (see [Figure 11](#))

PARAMETER	FROM (INPUT)	TO (OUTPUT)	$V_{CCB} = 1.2\text{ V}$			$V_{CCB} = 1.5\text{ V} \pm 0.1\text{ V}$			$V_{CCB} = 1.8\text{ V} \pm 0.15\text{ V}$			$V_{CCB} = 2.5\text{ V} \pm 0.2\text{ V}$			$V_{CCB} = 3.3\text{ V} \pm 0.3\text{ V}$			UNIT												
			MIN	TYP	MAX	MIN	TYP	MAX	MIN	TYP	MAX	MIN	TYP	MAX	MIN	TYP	MAX													
t_{PLH}	A	B	3.4			0.5			5.9			0.5			4.8			0.5			3.7			0.5			3.3			ns
t_{PHL}			3.4			0.5			5.9			0.5			4.8			0.5			3.7			0.5			3.3			
t_{PLH}	B	A	3			0.5			5.2			0.5			4.8			0.5			4.5			0.5			4.4			ns
t_{PHL}			3			0.5			5.2			0.5			4.8			0.5			4.5			0.5			4.4			
t_{PZH}	\overline{OE}	A	3.4			1			7.8			1			7.8			1			7.8			1			7.8			ns
t_{PZL}			3.4			1			7.8			1			7.8			1			7.8			1			7.8			
t_{PZH}	\overline{OE}	B	5.4			1			9.2			0.5			7.4			0.5			5.3			0.5			4.5			ns
t_{PZL}			5.4			1			9.2			0.5			7.4			0.5			5.3			0.5			4.5			
t_{PHZ}	\overline{OE}	A	4.2			1.5			7.7			1.5			7.7			1.5			7.7			1.5			7.7			ns
t_{PLZ}			4.2			1.5			7.7			1.5			7.7			1.5			7.7			1.5			7.7			
t_{PHZ}	\overline{OE}	B	5.2			1.5			8.4			1.5			7.1			1			5.9			1			5.7			ns
t_{PLZ}			5.2			1.5			8.4			1.5			7.1			1			5.9			1			5.7			

7.9 Switching Characteristics: $V_{CCA} = 2.5 \text{ V} \pm 0.2 \text{ V}$

 over recommended operating free-air temperature range, $V_{CCA} = 2.5 \text{ V} \pm 0.2 \text{ V}$ (see [Figure 11](#))

PARAMETER	FROM (INPUT)	TO (OUTPUT)	$V_{CCB} = 1.2 \text{ V}$			$V_{CCB} = 1.5 \text{ V} \pm 0.1 \text{ V}$			$V_{CCB} = 1.8 \text{ V} \pm 0.15 \text{ V}$			$V_{CCB} = 2.5 \text{ V} \pm 0.2 \text{ V}$			$V_{CCB} = 3.3 \text{ V} \pm 0.3 \text{ V}$			UNIT
			MIN	TYP	MAX	MIN	TYP	MAX	MIN	TYP	MAX	MIN	TYP	MAX	MIN	TYP	MAX	
t_{PLH}	A	B	3.2			0.5			0.5			0.5			0.5			ns
t_{PHL}			3.2			0.5			0.5			0.5			0.5			
t_{PLH}	B	A	2.6			0.5			0.5			0.5			0.5			ns
t_{PHL}			2.6			0.5			0.5			0.5			0.5			
t_{PZH}	\overline{OE}	A	2.5			0.5			0.5			0.5			0.5			ns
t_{PZL}			2.5			0.5			0.5			0.5			0.5			
t_{PZH}	\overline{OE}	B	5.2			0.5			0.5			0.5			0.5			ns
t_{PZL}			5.2			0.5			0.5			0.5			0.5			
t_{PHZ}	\overline{OE}	A	3			1			1			1			1			ns
t_{PLZ}			3			1			1			1			1			
t_{PHZ}	\overline{OE}	B	5			1			1			1			1			ns
t_{PLZ}			5			1			1			1			1			

7.10 Switching Characteristics: $V_{CCA} = 3.3 \text{ V} \pm 0.3 \text{ V}$

 over recommended operating free-air temperature range, $V_{CCA} = 3.3 \text{ V} \pm 0.3 \text{ V}$ (see [Figure 11](#))

PARAMETER	FROM (INPUT)	TO (OUTPUT)	$V_{CCB} = 1.2 \text{ V}$			$V_{CCB} = 1.5 \text{ V} \pm 0.1 \text{ V}$			$V_{CCB} = 1.8 \text{ V} \pm 0.15 \text{ V}$			$V_{CCB} = 2.5 \text{ V} \pm 0.2 \text{ V}$			$V_{CCB} = 3.3 \text{ V} \pm 0.3 \text{ V}$			UNIT
			MIN	TYP	MAX	MIN	TYP	MAX	MIN	TYP	MAX	MIN	TYP	MAX	MIN	TYP	MAX	
t_{PLH}	A	B	3.2			0.5			0.5			0.5			0.5			ns
t_{PHL}			3.2			0.5			0.5			0.5			0.5			
t_{PLH}	B	A	2.8			0.5			0.5			0.5			0.5			ns
t_{PHL}			2.8			0.5			0.5			0.5			0.5			
t_{PZH}	\overline{OE}	A	2.2			0.5			0.5			0.5			0.5			ns
t_{PZL}			2.2			0.5			0.5			0.5			0.5			
t_{PZH}	\overline{OE}	B	5.1			0.5			0.5			0.5			0.5			ns
t_{PZL}			5.1			0.5			0.5			0.5			0.5			
t_{PHZ}	\overline{OE}	A	3.4			0.5			0.5			0.5			0.5			ns
t_{PLZ}			3.4			0.5			0.5			0.5			0.5			
t_{PHZ}	\overline{OE}	B	4.9			1			1			1			1			ns
t_{PLZ}			4.9			1			1			1			1			

7.11 Operating Characteristics

 $T_A = 25^\circ\text{C}$

PARAMETER			TEST CONDITIONS	$V_{CCA} = V_{CCB} = 1.2 \text{ V}$			$V_{CCA} = V_{CCB} = 1.5 \text{ V}$			$V_{CCA} = V_{CCB} = 1.8 \text{ V}$			$V_{CCA} = V_{CCB} = 2.5 \text{ V}$			$V_{CCA} = V_{CCB} = 3.3 \text{ V}$			UNIT
				MIN	TYP	MAX	MIN	TYP	MAX	MIN	TYP	MAX	MIN	TYP	MAX	MIN	TYP	MAX	
$C_{pdA}^{(1)}$	A to B	Outputs enabled	1			1			1			1			2			pF	
		Outputs disabled	1			1			1			1			1				
	B to A	Outputs enabled	13			13			14			15			16				
		Outputs disabled	1			1			1			1			1				
$C_{pdB}^{(1)}$	A to B	Outputs enabled	13			13			14			15			16			pF	
		Outputs disabled	1			1			1			1			1				
	B to A	Outputs enabled	1			1			1			1			2				
		Outputs disabled	1			1			1			1			1				

(1) Power dissipation capacitance per transceiver. Refer to the TI application report, *CMOS Power Consumption and Cpd Calculation*, [SCAA035](#)

7.12 Typical Characteristics

T_A = 25°C

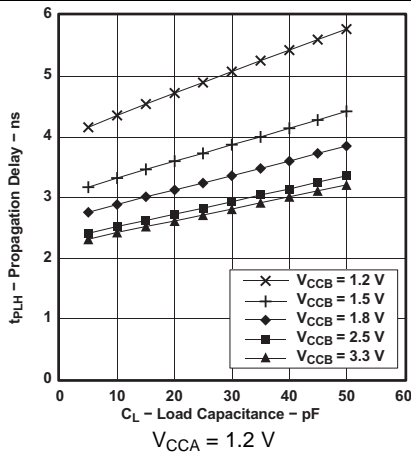

Figure 1. Typical Propagation Delay t_{PLH} (A to B) vs Load Capacitance

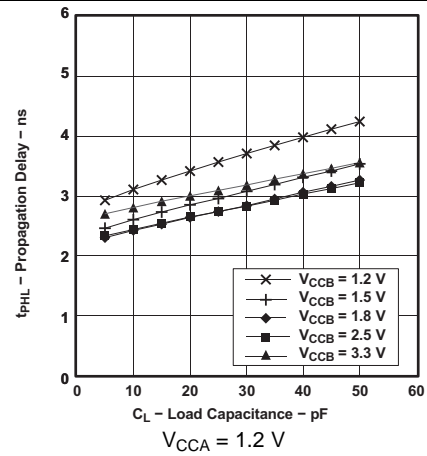

Figure 2. Typical Propagation Delay t_{PHL} (A to B) vs Load Capacitance

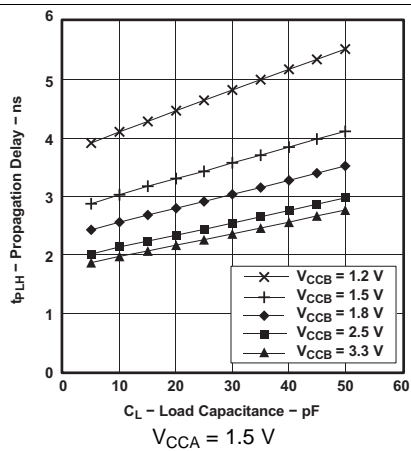

Figure 3. Typical Propagation Delay t_{PLH} (A to B) vs Load Capacitance

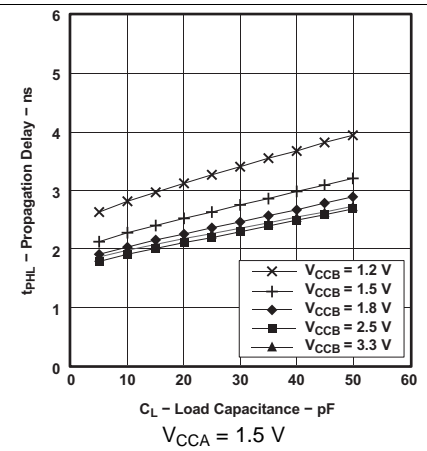

Figure 4. Typical Propagation Delay t_{PHL} (A to B) vs Load Capacitance

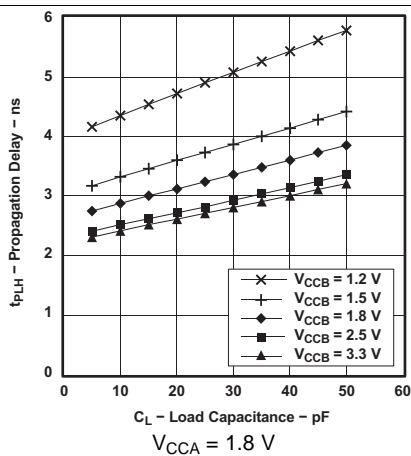

Figure 5. Typical Propagation Delay t_{PLH} (A to B) vs Load Capacitance

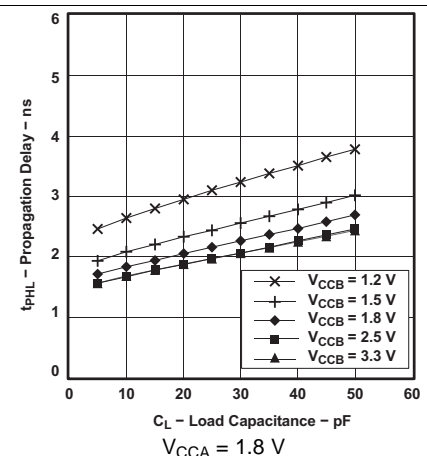

Figure 6. Typical Propagation Delay t_{PHL} (A to B) vs Load Capacitance

Typical Characteristics (continued)

T_A = 25°C

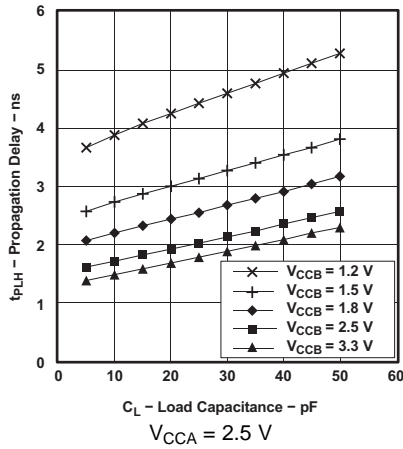

Figure 7. Typical Propagation Delay t_{PLH} (A to B) vs Load Capacitance

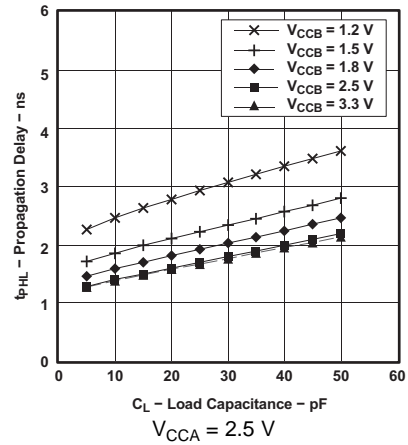

Figure 8. Typical Propagation Delay t_{PHL} (A to B) vs Load Capacitance

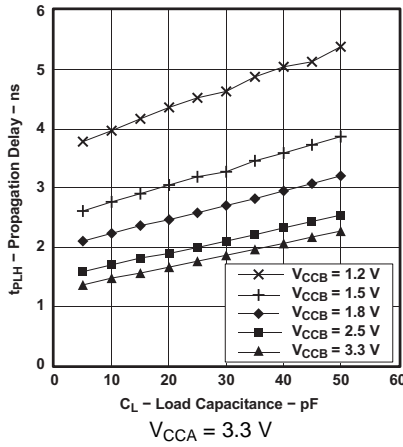

Figure 9. Typical Propagation Delay t_{PLH} (A to B) vs Load Capacitance

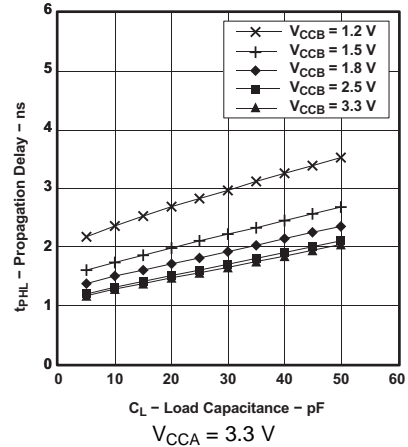
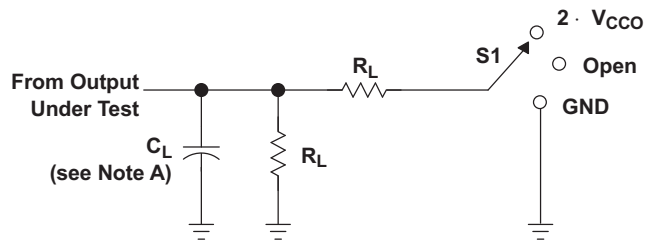

Figure 10. Typical Propagation Delay t_{PHL} (A to B) vs Load Capacitance

8 Parameter Measurement Information

LOAD CIRCUIT

TEST	S1
t_{pd}	Open
t_{PLZ}/t_{PZL}	$2 \cdot V_{CCO}$
t_{PHZ}/t_{PZH}	GND

V_{CCO}	C_L	R_L	V_{TP}
1.2 V	15 pF	2 k Ω	0.1 V
1.5 V \pm 0.1 V	15 pF	2 k Ω	0.1 V
1.8 V \pm 0.15 V	15 pF	2 k Ω	0.15 V
2.5 V \pm 0.2 V	15 pF	2 k Ω	0.15 V
3.3 V \pm 0.3 V	15 pF	2 k Ω	0.3 V

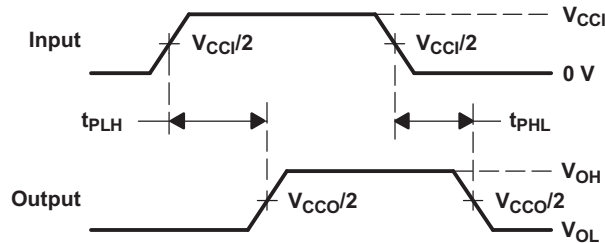
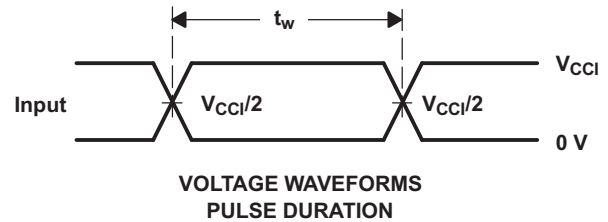
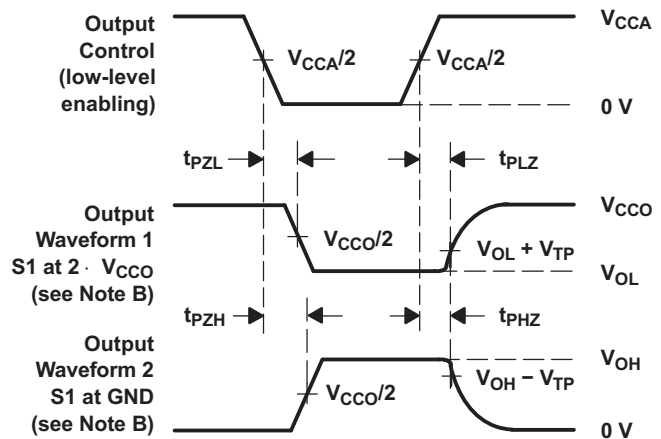
**VOLTAGE WAVEFORMS
PROPAGATION DELAY TIMES**

**VOLTAGE WAVEFORMS
ENABLE AND DISABLE TIMES**

- NOTES:
- C_L includes probe and jig capacitance.
 - Waveform 1 is for an output with internal conditions such that the output is low except when disabled by the output control. Waveform 2 is for an output with internal conditions such that the output is high, except when disabled by the output control.
 - All input pulses are supplied by generators having the following characteristics: PRR = 10 MHz, $Z_O = 50 \Omega$, $dv/dt \geq 1$ V/ns.
 - The outputs are measured one at a time, with one transition per measurement.
 - t_{PLH} and t_{PHL} are the same as t_{pd} .
 - V_{CCI} is the V_{CC} associated with the input port.
 - V_{CCO} is the V_{CC} associated with the output port.

Figure 11. Load Circuit and Voltage Waveforms

9 Detailed Description

9.1 Overview

The SN74AVC16T245 is a 16-bit, dual-supply noninverting bidirectional voltage level translation. Pins A and control pins (DIR and \overline{OE}) are supported by V_{CCA} and pins B are supported by V_{CCB} . The A port can accept I/O voltages ranging from 1.2 V to 3.6 V, while the B port can accept I/O voltages from 1.2 V to 3.6 V. A high on DIR allows data transmission from A to B and a low on DIR allows data transmission from B to A when \overline{OE} is set to low. When \overline{OE} is set to high, both A and B are in the high-impedance state.

This device is fully specified for partial-power-down applications using off output current (I_{off}).

The V_{CC} isolation feature ensures that if either V_{CC} input is at GND, both ports are put in a high-impedance state.

9.2 Functional Block Diagram

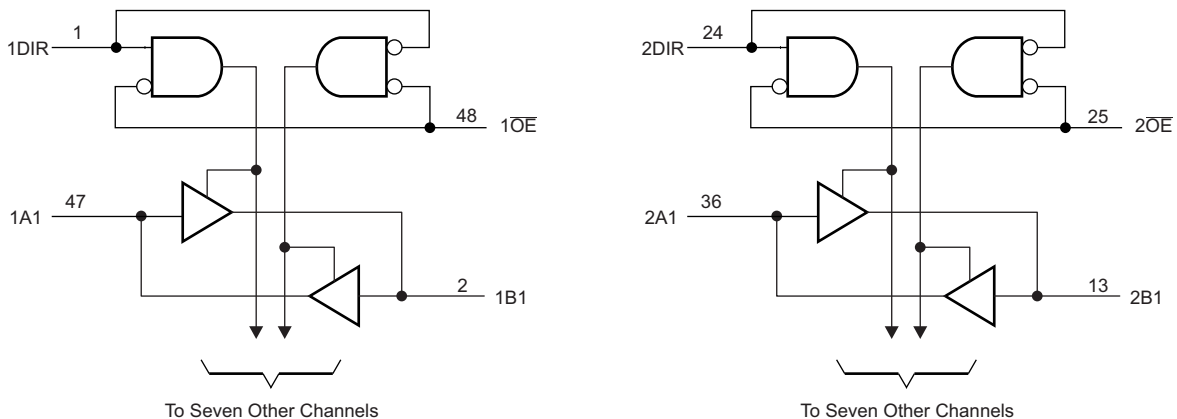

9.3 Feature Description

9.3.1 Fully Configurable Dual-Rail Design Allows Each Port to Operate Over the Full 1.2-V to 3.6-V Power-Supply Range

Both V_{CCA} and V_{CCB} can be supplied at any voltage from 1.2 V to 3.6 V making the device suitable for translating between any of the low voltage nodes (1.2 V, 1.8 V, 2.5 V, and 3.3 V).

9.3.2 Partial-Power-Down Mode Operation

This device is fully specified for partial-power-down applications using off output current (I_{off}). The I_{off} circuitry will prevent backflow current by disabling I/O output circuits when device is in partial power-down mode.

9.3.3 V_{CC} Isolation

The V_{CC} isolation feature ensures that if either V_{CCA} or V_{CCB} are at GND, both ports will be in a high-impedance state (I_{OZ} shown in [Electrical Characteristics](#)). This prevents false logic levels from being presented to either bus.

9.4 Device Functional Modes

The SN74AVC16T245 is a voltage level translator that can operate from 1.2 V to 3.6 V (V_{CCA}) and 1.2 V to 3.6 V (V_{CCB}). The signal translation between 1.2 V and 3.6 V requires direction control and output enable control. When \overline{OE} is low and DIR is high, data transmission is from A to B. When \overline{OE} is low and DIR is low, data transmission is from B to A. When \overline{OE} is high, both output ports will be high-impedance.

Table 1. Functions Table⁽¹⁾

CONTROL INPUTS		OUTPUT CIRCUITS		OPERATION
\overline{OE}	DIR	A PORT	B PORT	
L	L	Enabled	Hi-Z	B data to A bus
L	H	Hi-Z	Enabled	A data to B bus
H	X	Hi-Z	Hi-Z	Isolation

(1) Input circuits of the data I/Os always are active.

10 Application and Implementation

NOTE

Information in the following applications sections is not part of the TI component specification, and TI does not warrant its accuracy or completeness. TI's customers are responsible for determining suitability of components for their purposes. Customers should validate and test their design implementation to confirm system functionality.

10.1 Application Information

The SN74AVC16T245 device can be used in level-shifting applications for interfacing devices and addressing mixed voltage incompatibility. The SN74AVC16T245 device is ideal for data transmission where direction is different for each channel.

10.1.1 Enable Times

Calculate the enable times for the SN74AVC16T45 using the following formulas:

$$t_{PZH} \text{ (DIR to A)} = t_{PLZ} \text{ (DIR to B)} + t_{PLH} \text{ (B to A)} \quad (1)$$

$$t_{PZL} \text{ (DIR to A)} = t_{PHZ} \text{ (DIR to B)} + t_{PHL} \text{ (B to A)} \quad (2)$$

$$t_{PZH} \text{ (DIR to B)} = t_{PLZ} \text{ (DIR to A)} + t_{PLH} \text{ (A to B)} \quad (3)$$

$$t_{PZL} \text{ (DIR to B)} = t_{PHZ} \text{ (DIR to A)} + t_{PHL} \text{ (A to B)} \quad (4)$$

In a bidirectional application, these enable times provide the maximum delay from the time the DIR bit is switched until an output is expected. For example, if the SN74AVC16T245 initially is transmitting from A to B, then the DIR bit is switched; the B port of the device must be disabled before presenting it with an input. After the B port has been disabled, an input signal applied to it appears on the corresponding A port after the specified propagation delay.

10.2 Typical Application

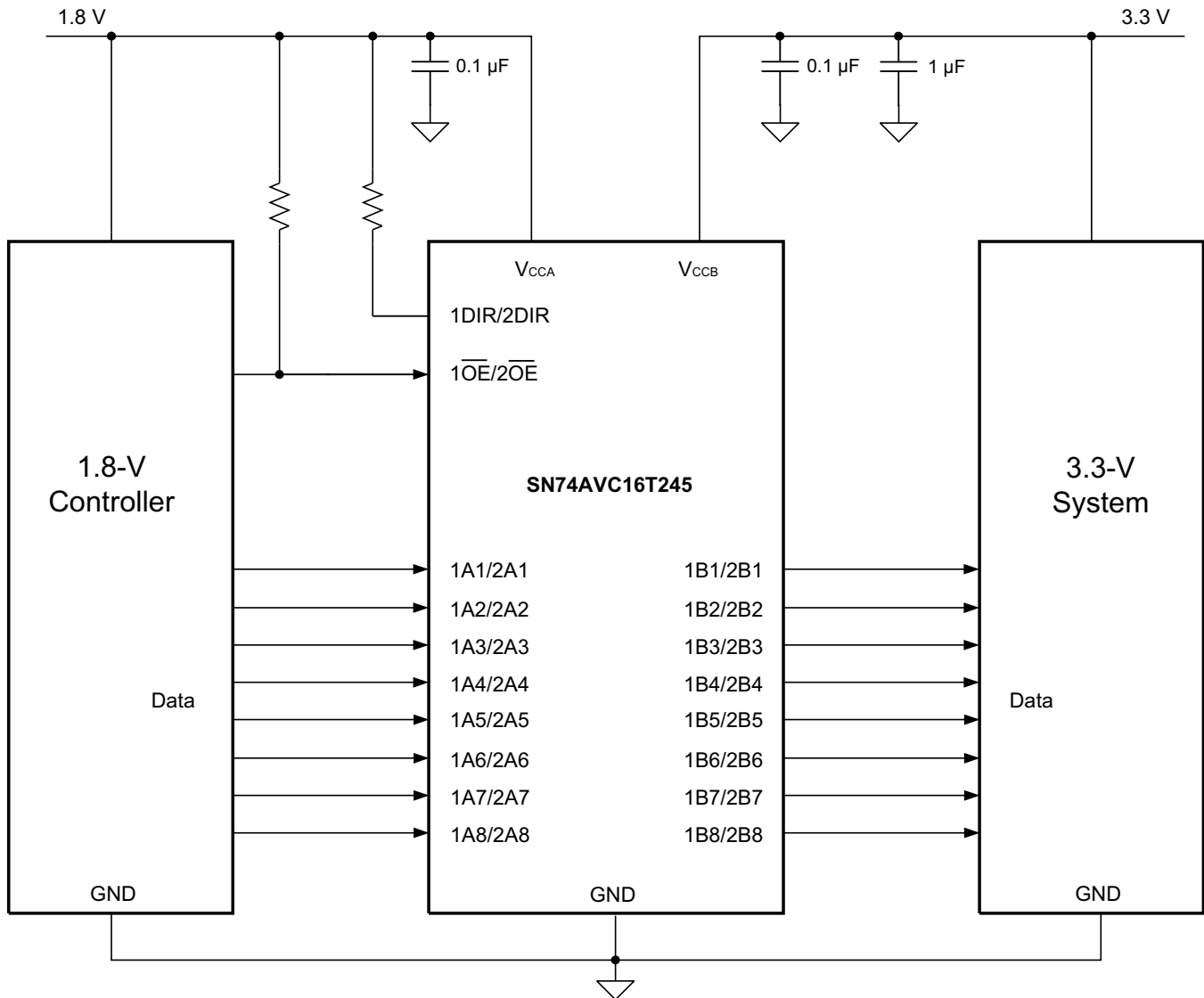

Figure 12. Typical Application Schematic

10.2.1 Design Requirements

This device uses drivers which are enabled depending on the state of the DIR pin. The designer must know the intended flow of data and take care not to violate any of the high or low logic levels. Unused data inputs must not be floating, as this can cause excessive internal leakage on the input CMOS structure. Tie any unused input and output ports directly to ground.

For this design example, use the parameters listed in [Table 2](#).

Table 2. Design Parameters

DESIGN PARAMETER	EXAMPLE VALUE
Input voltage range	1.2 V to 3.6 V
Output voltage range	1.2 V to 3.6 V

10.2.2 Detailed Design Procedure

To begin the design process, determine the following:

10.2.2.1 Input Voltage Ranges

Use the supply voltage of the device that is driving the SN74AVC16T245 device to determine the input voltage range. For a valid logic high the value must exceed the V_{IH} of the input port. For a valid logic low the value must be less than the V_{IL} of the input port.

10.2.2.2 Output Voltage Range

Use the supply voltage of the device that the SN74AVC16T245 device is driving to determine the output voltage range.

10.2.3 Application Curve

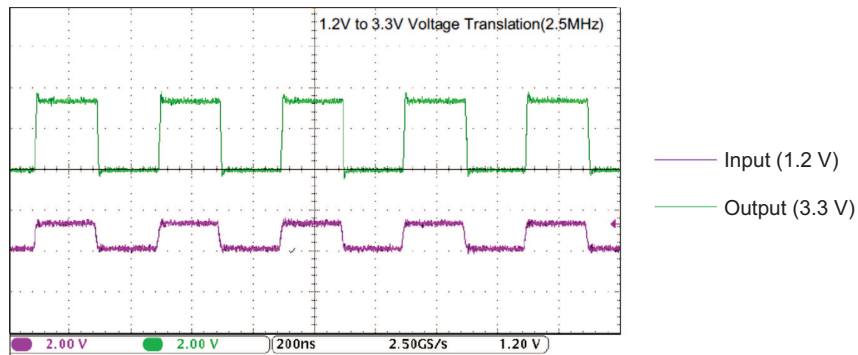

Figure 13. Translation Up (1.2 V to 3.3 V) at 2.5 MHz

11 Power Supply Recommendations

The SN74AVC16T245 device uses two separate configurable power-supply rails, V_{CCA} and V_{CCB} . V_{CCA} accepts any supply voltage from 1.2 V to 3.6 V and V_{CCB} accepts any supply voltage from 1.2 V to 3.6 V. The A port and B port are designed to track V_{CCA} and V_{CCB} , respectively, allowing for low-voltage bidirectional translation between any of the 1.2-V, 1.5-V, 1.8-V, 2.5-V and 3.3-V voltage nodes.

The output-enable \overline{OE} input circuit is designed so that it is supplied by V_{CCA} and when the \overline{OE} input is high, all outputs are placed in the high-impedance state. To ensure the high-impedance state of the outputs during power up or power down, the \overline{OE} input pin must be tied to V_{CCA} through a pullup resistor and must not be enabled until V_{CCA} and V_{CCB} are fully ramped and stable. The minimum value of the pullup resistor to V_{CCA} is determined by the current-sinking capability of the driver.

12 Layout

12.1 Layout Guidelines

To ensure reliability of the device, following common printed-circuit-board layout guidelines is recommended.

- Bypass capacitors should be used on power supplies.
- Short trace lengths should be used to avoid excessive loading.
- Placing pads on the signal paths for loading capacitors or pullup resistors to help adjust rise and fall times of signals depending on the system requirements.

12.2 Layout Example

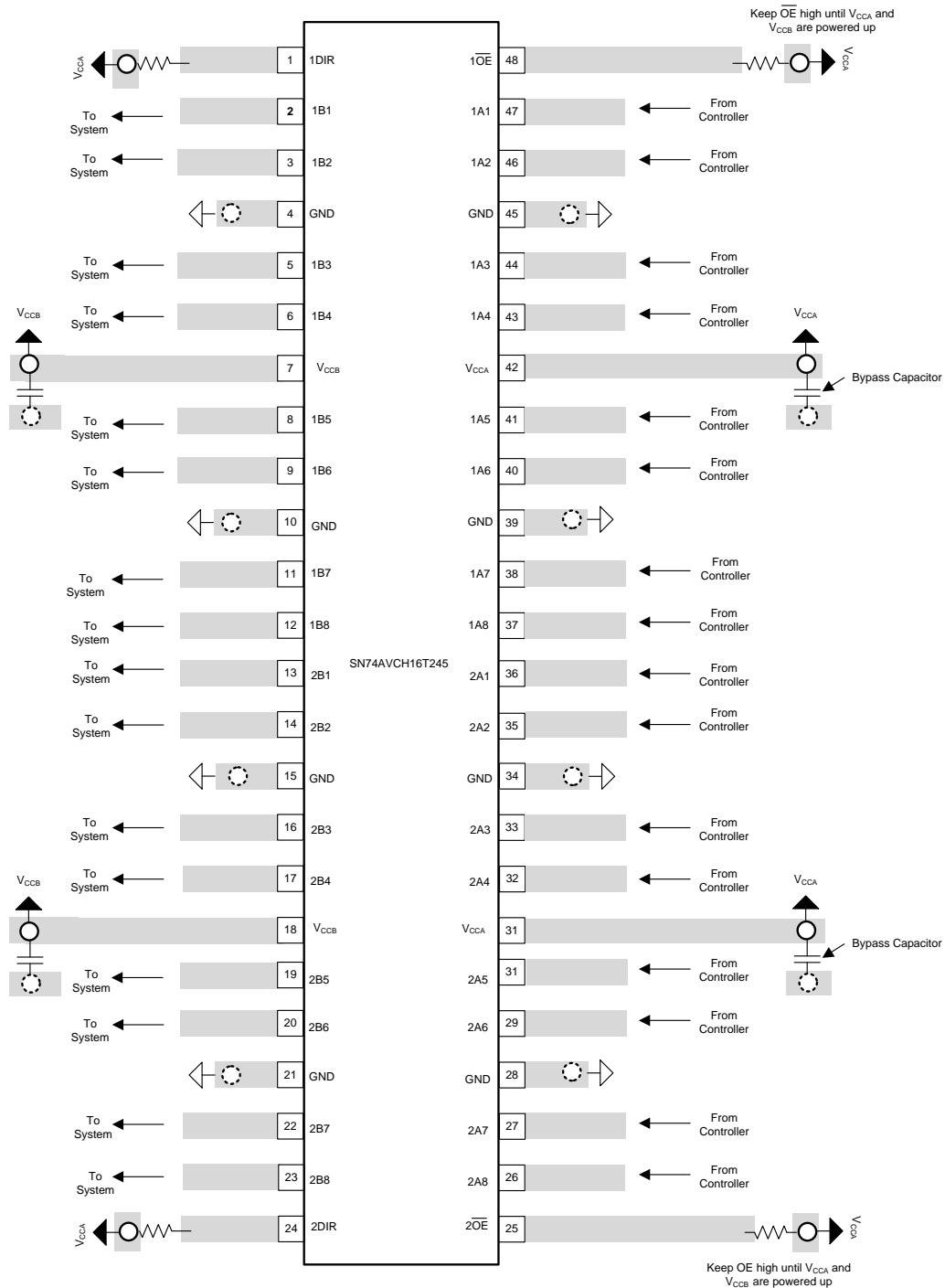
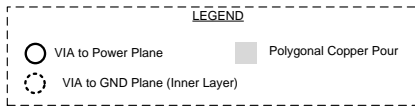

Figure 14. Recommended Layout Example

13 Device and Documentation Support

13.1 Documentation Support

13.1.1 Related Documentation

For related documentation see the following:

- *CMOS Power Consumption and Cpd Calculation*, [SCAA035](#)
- *Implications of Slow or Floating CMOS Inputs*, [SCBA004](#)

13.2 Community Resources

The following links connect to TI community resources. Linked contents are provided "AS IS" by the respective contributors. They do not constitute TI specifications and do not necessarily reflect TI's views; see TI's [Terms of Use](#).

TI E2E™ Online Community *TI's Engineer-to-Engineer (E2E) Community*. Created to foster collaboration among engineers. At [e2e.ti.com](#), you can ask questions, share knowledge, explore ideas and help solve problems with fellow engineers.

Design Support *TI's Design Support* Quickly find helpful E2E forums along with design support tools and contact information for technical support.

13.3 Trademarks

E2E is a trademark of Texas Instruments.

All other trademarks are the property of their respective owners.

13.4 Electrostatic Discharge Caution



These devices have limited built-in ESD protection. The leads should be shorted together or the device placed in conductive foam during storage or handling to prevent electrostatic damage to the MOS gates.

13.5 Glossary

[SLYZ022](#) — *TI Glossary*.

This glossary lists and explains terms, acronyms, and definitions.

14 Mechanical, Packaging, and Orderable Information

The following pages include mechanical, packaging, and orderable information. This information is the most current data available for the designated devices. This data is subject to change without notice and revision of this document. For browser-based versions of this data sheet, refer to the left-hand navigation.

PACKAGING INFORMATION

Orderable Device	Status (1)	Package Type	Package Drawing	Pins	Package Qty	Eco Plan (2)	Lead/Ball Finish (6)	MSL Peak Temp (3)	Op Temp (°C)	Device Marking (4/5)	Samples
74AVC16T245DGGRE4	ACTIVE	TSSOP	DGG	48	2000	Green (RoHS & no Sb/Br)	CU NIPDAU	Level-1-260C-UNLIM	-40 to 85	AVC16T245	Samples
74AVC16T245DGVRE4	ACTIVE	TVSOP	DGV	48	2000	Green (RoHS & no Sb/Br)	CU NIPDAU	Level-1-260C-UNLIM	-40 to 85	WF245	Samples
AVC16T245DGGR-D	ACTIVE	TSSOP	DGG	48	2000	Green (RoHS & no Sb/Br)	CU NIPDAU	Level-1-260C-UNLIM	-40 to 85	AVC16T245	Samples
SN74AVC16T245DGG	ACTIVE	TSSOP	DGG	48	40	Green (RoHS & no Sb/Br)	CU NIPDAU	Level-1-260C-UNLIM	-40 to 85	AVC16T245	Samples
SN74AVC16T245DGGR	ACTIVE	TSSOP	DGG	48	2000	Green (RoHS & no Sb/Br)	CU NIPDAU	Level-1-260C-UNLIM	-40 to 85	AVC16T245	Samples
SN74AVC16T245DGVR	ACTIVE	TVSOP	DGV	48	2000	Green (RoHS & no Sb/Br)	CU NIPDAU	Level-1-260C-UNLIM	-40 to 85	WF245	Samples
SN74AVC16T245ZQLR	ACTIVE	BGA MICROSTAR JUNIOR	ZQL	56	1000	Green (RoHS & no Sb/Br)	SNAGCU	Level-1-260C-UNLIM	-40 to 85	WF245	Samples

(1) The marketing status values are defined as follows:

ACTIVE: Product device recommended for new designs.

LIFEBUY: TI has announced that the device will be discontinued, and a lifetime-buy period is in effect.

NRND: Not recommended for new designs. Device is in production to support existing customers, but TI does not recommend using this part in a new design.

PREVIEW: Device has been announced but is not in production. Samples may or may not be available.

OBSOLETE: TI has discontinued the production of the device.

(2) **RoHS:** TI defines "RoHS" to mean semiconductor products that are compliant with the current EU RoHS requirements for all 10 RoHS substances, including the requirement that RoHS substance do not exceed 0.1% by weight in homogeneous materials. Where designed to be soldered at high temperatures, "RoHS" products are suitable for use in specified lead-free processes. TI may reference these types of products as "Pb-Free".

RoHS Exempt: TI defines "RoHS Exempt" to mean products that contain lead but are compliant with EU RoHS pursuant to a specific EU RoHS exemption.

Green: TI defines "Green" to mean the content of Chlorine (Cl) and Bromine (Br) based flame retardants meet JS709B low halogen requirements of <=1000ppm threshold. Antimony trioxide based flame retardants must also meet the <=1000ppm threshold requirement.

(3) MSL, Peak Temp. - The Moisture Sensitivity Level rating according to the JEDEC industry standard classifications, and peak solder temperature.

(4) There may be additional marking, which relates to the logo, the lot trace code information, or the environmental category on the device.

(5) Multiple Device Markings will be inside parentheses. Only one Device Marking contained in parentheses and separated by a "-" will appear on a device. If a line is indented then it is a continuation of the previous line and the two combined represent the entire Device Marking for that device.

(6) Lead/Ball Finish - Orderable Devices may have multiple material finish options. Finish options are separated by a vertical ruled line. Lead/Ball Finish values may wrap to two lines if the finish value exceeds the maximum column width.

Important Information and Disclaimer:The information provided on this page represents TI's knowledge and belief as of the date that it is provided. TI bases its knowledge and belief on information provided by third parties, and makes no representation or warranty as to the accuracy of such information. Efforts are underway to better integrate information from third parties. TI has taken and continues to take reasonable steps to provide representative and accurate information but may not have conducted destructive testing or chemical analysis on incoming materials and chemicals. TI and TI suppliers consider certain information to be proprietary, and thus CAS numbers and other limited information may not be available for release.

In no event shall TI's liability arising out of such information exceed the total purchase price of the TI part(s) at issue in this document sold by TI to Customer on an annual basis.

OTHER QUALIFIED VERSIONS OF SN74AVC16T245 :

- Automotive: [SN74AVC16T245-Q1](#)

NOTE: Qualified Version Definitions:

- Automotive - Q100 devices qualified for high-reliability automotive applications targeting zero defects

TAPE AND REEL INFORMATION



QUADRANT ASSIGNMENTS FOR PIN 1 ORIENTATION IN TAPE



*All dimensions are nominal

Device	Package Type	Package Drawing	Pins	SPQ	Reel Diameter (mm)	Reel Width W1 (mm)	A0 (mm)	B0 (mm)	K0 (mm)	P1 (mm)	W (mm)	Pin1 Quadrant
SN74AVC16T245DGGR	TSSOP	DGG	48	2000	330.0	24.4	8.6	13.0	1.8	12.0	24.0	Q1
SN74AVC16T245DGVR	TVSOP	DGV	48	2000	330.0	16.4	7.1	10.2	1.6	12.0	16.0	Q1
SN74AVC16T245ZQLR	BGA MICROSTAR JUNIOR	ZQL	56	1000	330.0	16.4	4.8	7.3	1.5	8.0	16.0	Q1

TAPE AND REEL BOX DIMENSIONS



*All dimensions are nominal

Device	Package Type	Package Drawing	Pins	SPQ	Length (mm)	Width (mm)	Height (mm)
SN74AVC16T245DGGR	TSSOP	DGG	48	2000	367.0	367.0	45.0
SN74AVC16T245DGVR	TVSOP	DGV	48	2000	367.0	367.0	38.0
SN74AVC16T245ZQLR	BGA MICROSTAR JUNIOR	ZQL	56	1000	350.0	350.0	43.0

DGG (R-PDSO-G**)

PLASTIC SMALL-OUTLINE PACKAGE

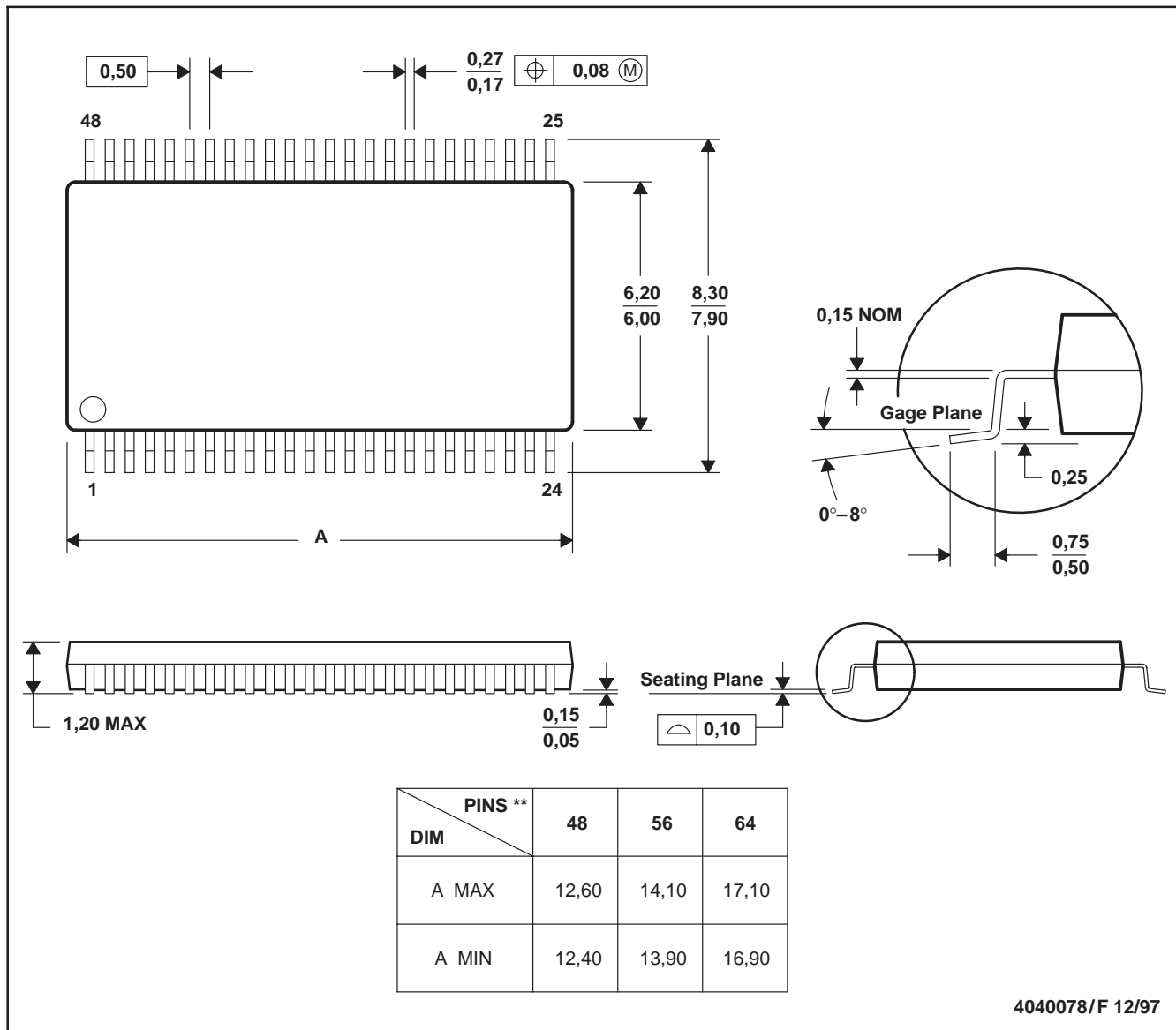
48 PINS SHOWN



- NOTES: A. All linear dimensions are in millimeters.
 B. This drawing is subject to change without notice.
 C. Body dimensions do not include mold protrusion not to exceed 0,15.
 D. Falls within JEDEC MO-153

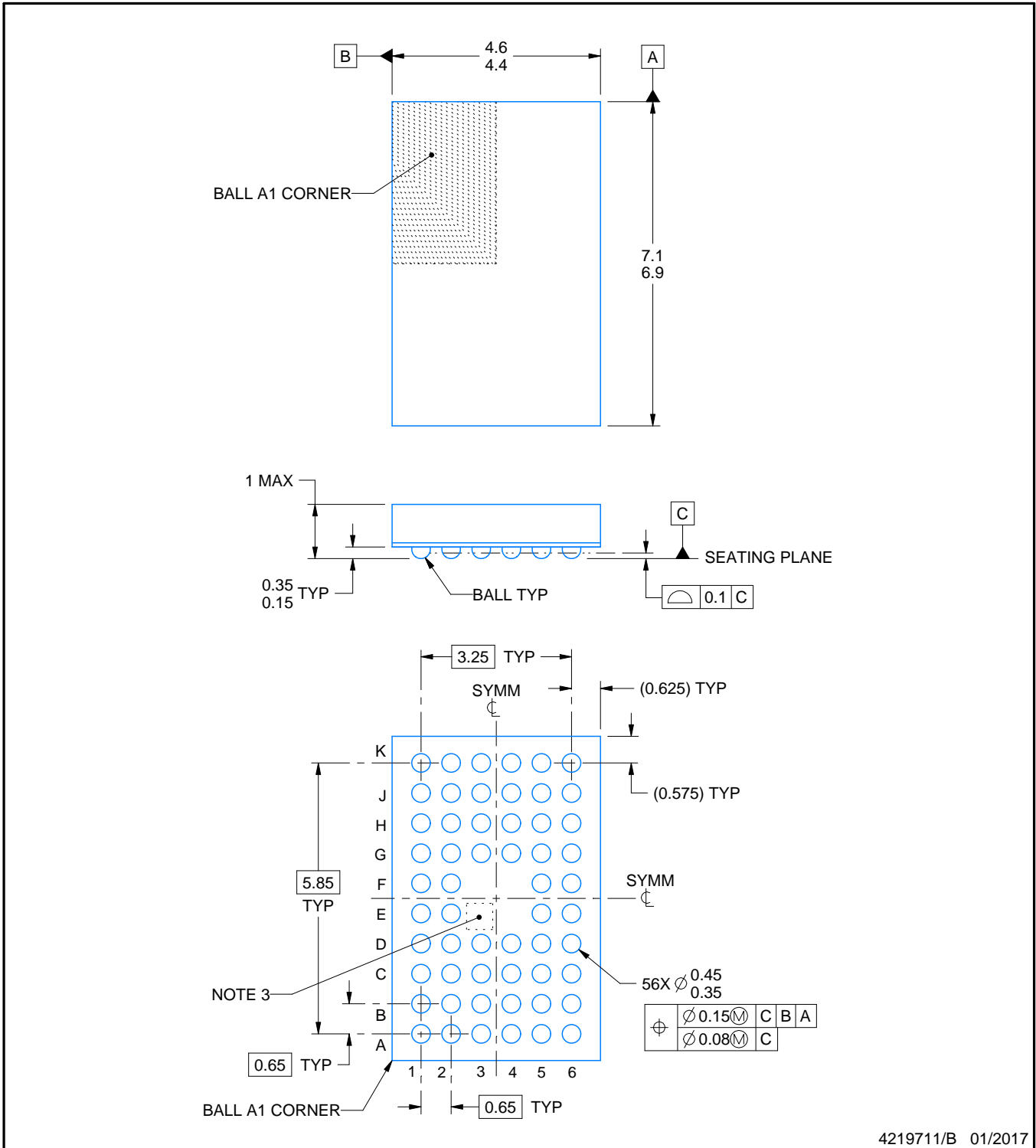
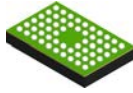

4219711/B 01/2017

NOTES:

1. All linear dimensions are in millimeters. Any dimensions in parenthesis are for reference only. Dimensioning and tolerancing per ASME Y14.5M.
2. This drawing is subject to change without notice.
3. No metal in this area, indicates orientation.

EXAMPLE BOARD LAYOUT

ZQL0056A

JRBGA - 1 mm max height

PLASTIC BALL GRID ARRAY

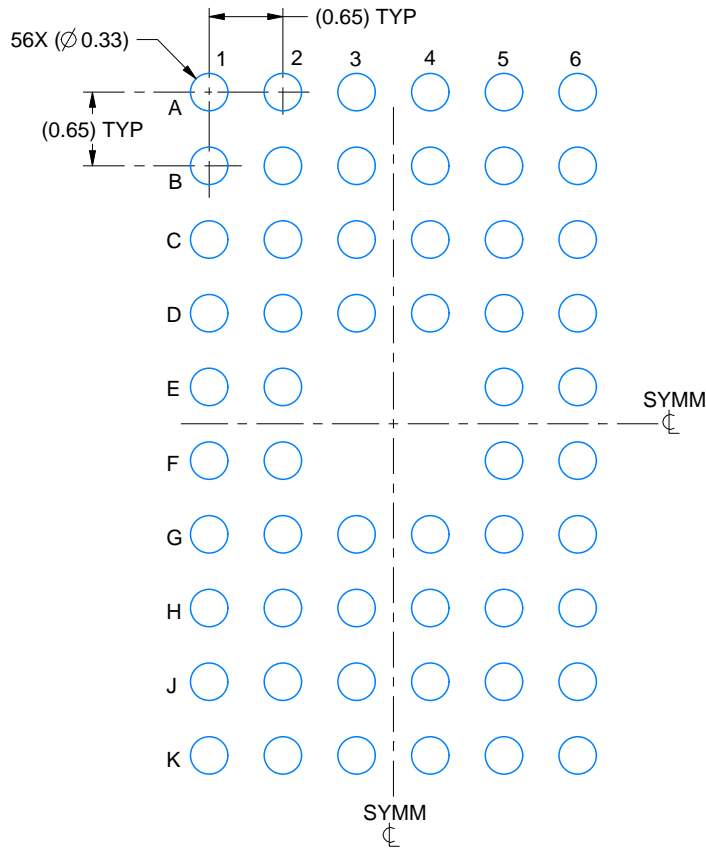

LAND PATTERN EXAMPLE
EXPOSED METAL SHOWN
SCALE:15X

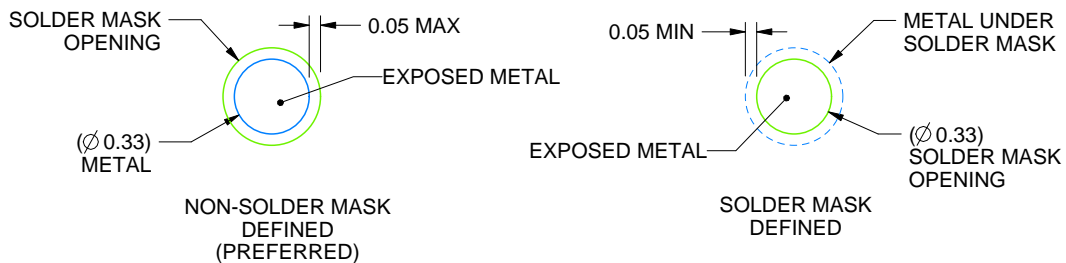

SOLDER MASK DETAILS
NOT TO SCALE

4219711/B 01/2017

NOTES: (continued)

- Final dimensions may vary due to manufacturing tolerance considerations and also routing constraints. For information, see Texas Instruments literature number SPRAA99 (www.ti.com/lit/spraa99).

EXAMPLE STENCIL DESIGN

ZQL0056A

JRBGA - 1 mm max height

PLASTIC BALL GRID ARRAY

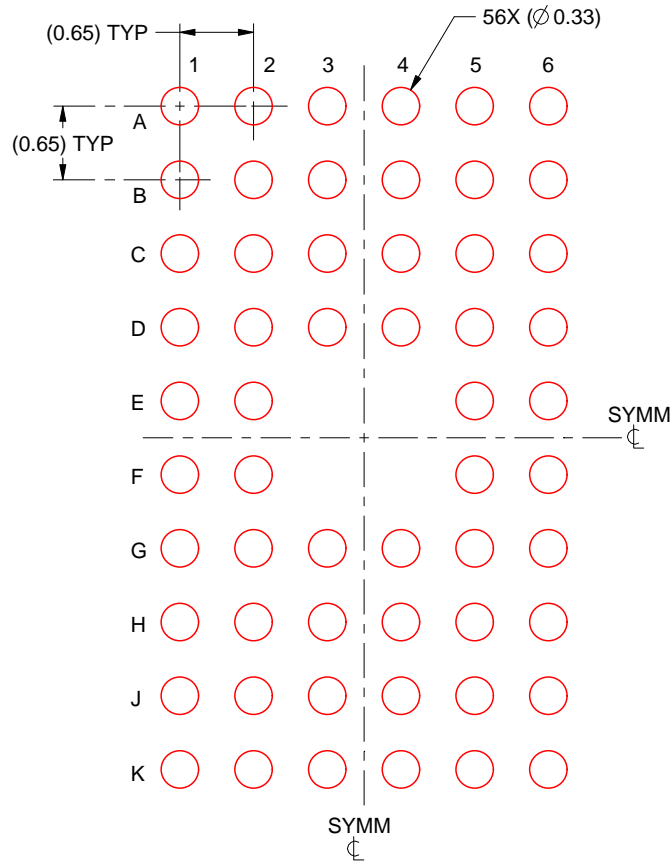

SOLDER PASTE EXAMPLE
BASED ON 0.125 mm THICK STENCIL
SCALE:15X

4219711/B 01/2017

NOTES: (continued)

5. Laser cutting apertures with trapezoidal walls and rounded corners may offer better paste release.

IMPORTANT NOTICE AND DISCLAIMER

TI PROVIDES TECHNICAL AND RELIABILITY DATA (INCLUDING DATASHEETS), DESIGN RESOURCES (INCLUDING REFERENCE DESIGNS), APPLICATION OR OTHER DESIGN ADVICE, WEB TOOLS, SAFETY INFORMATION, AND OTHER RESOURCES "AS IS" AND WITH ALL FAULTS, AND DISCLAIMS ALL WARRANTIES, EXPRESS AND IMPLIED, INCLUDING WITHOUT LIMITATION ANY IMPLIED WARRANTIES OF MERCHANTABILITY, FITNESS FOR A PARTICULAR PURPOSE OR NON-INFRINGEMENT OF THIRD PARTY INTELLECTUAL PROPERTY RIGHTS.

These resources are intended for skilled developers designing with TI products. You are solely responsible for (1) selecting the appropriate TI products for your application, (2) designing, validating and testing your application, and (3) ensuring your application meets applicable standards, and any other safety, security, or other requirements. These resources are subject to change without notice. TI grants you permission to use these resources only for development of an application that uses the TI products described in the resource. Other reproduction and display of these resources is prohibited. No license is granted to any other TI intellectual property right or to any third party intellectual property right. TI disclaims responsibility for, and you will fully indemnify TI and its representatives against, any claims, damages, costs, losses, and liabilities arising out of your use of these resources.

TI's products are provided subject to TI's Terms of Sale (www.ti.com/legal/termsofsale.html) or other applicable terms available either on ti.com or provided in conjunction with such TI products. TI's provision of these resources does not expand or otherwise alter TI's applicable warranties or warranty disclaimers for TI products.

Mailing Address: Texas Instruments, Post Office Box 655303, Dallas, Texas 75265
Copyright © 2019, Texas Instruments Incorporated

Looking for pricing, stock, or lifecycle information?

Click below to explore more details on WIN SOURCE:

 [View SN74AVC16T245DGVR on WIN SOURCE](#)

 [Texas Instruments](#) Information

Optimize Your Supply Chain with WIN SOURCE Solutions

-  Global Sourcing Solution
-  Obsolete Management
-  Cost Control Management
-  Shortage Management
-  Alternative Solution
-  Excess Inventory Management