



THE DATASHEET OF SN65HVD62RGTR



SN65HVD62 AISG On-Off Keying Coax Modem Transceiver

1 Features

- Supply Ranging From 3V to 5.5V
- Independent Logic Supply of 1.6V to 5.5V
- Wide Input Dynamic Range of -15dBm to $+5\text{dBm}$ for Receiver
- Power Delivered by the Driver to the Coax can be Adjusted From 0dBm to $+6\text{dBm}$
- AISG Compliant Output Emission Profile
- Low-power Standby Mode
- Direction Control Output for RS-485 Bus Arbitration
- Supports up to 115 kbps Signaling
- Integrated Active Bandpass Filter with Center Frequency at 2.176MHz
- 3mm x 3mm 16-Pin QFN Package

2 Applications

- AISG – Interface for Antenna Line Devices
- Tower Mounted Amplifiers (TMA)
- General Modem Interfaces

3 Description

These transceivers modulate and demodulate signals between the logic (baseband) and a frequency suitable for long coaxial media.

The HVD62 is an integrated AISG transceiver designed to be compliant with Antenna Interface Standards Group v2.0 specification.

The HVD62 receiver integrates an active bandpass filter to enable demodulation of signals even in the presence of spurious frequency components. The filter has a 2.176 MHz center frequency.

The transmitter supports adjustable output power levels varying from $+0\text{dBm}$ to $+6\text{dBm}$ delivered to the $50\ \Omega$ coax cable. The HVD62 transmitter is compliant with the spectrum emission requirement provided by the AISG standard.

A direction control output is provided which facilitates bus arbitration for an RS-485 interface. These devices integrate an oscillator input for a crystal, and also accept standard clock inputs to the oscillator.

Device Information⁽¹⁾

PART NUMBER	PACKAGE	BODY SIZE (NOM)
SN65HVD62	VQFN (16)	3.00 mm x 3.00 mm

(1) For all available packages, see the orderable addendum at the end of the data sheet.

4 Block Diagram

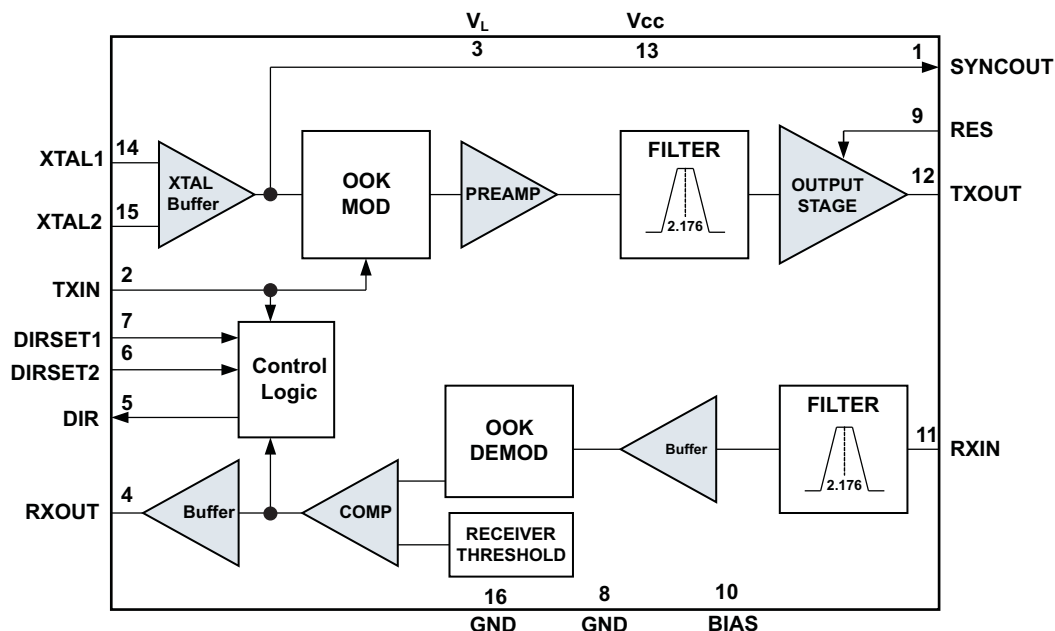

Table of Contents

1 Features	1	8 Parameter Measurement Information	11
2 Applications	1	9 Detailed Description	14
3 Description	1	9.1 Overview	14
4 Block Diagram	1	9.2 Functional Block Diagram	14
5 Revision History	2	9.3 Device Functional Modes	14
6 Pin Configuration and Functions	3	10 Application and Implementation	16
7 Specifications	4	10.1 Application Information	16
7.1 Absolute Maximum Ratings	4	11 Device and Documentation Support	18
7.2 ESD Ratings	4	11.1 Documentation Support	18
7.3 Thermal Information	4	11.2 Trademarks	18
7.4 Recommended Operating Conditions	5	11.3 Electrostatic Discharge Caution	18
7.5 Electrical Characteristics	6	11.4 Glossary	18
7.6 Switching Characteristics	7	12 Mechanical, Packaging, and Orderable Information	18
7.7 Typical Characteristics	8		

5 Revision History

NOTE: Page numbers for previous revisions may differ from page numbers in the current version.

Changes from Revision B (January 2013) to Revision C

Page

• Added <i>Device Information</i> table, <i>ESD Ratings</i> table, <i>Device Functional Modes</i> , <i>Application and Implementation</i> section, <i>Device and Documentation Support</i> section, and <i>Mechanical, Packaging, and Orderable Information</i> section.	1
• Moved the Storage temperature From: <i>Thermal Information</i> To: <i>Absolute Maximum Ratings</i> ⁽¹⁾	4
• Changed T _A in the <i>Recommended Operating Conditions</i> From: MAX = 85°C To: MAX = 105°C	5

Changes from Revision A (January 2012) to Revision B

Page

• Changed <i>Features</i> From: "Power Delivered by the Driver to the Coax can be Adjusted +3dBm to +6dBm" To: "Power Delivered by the Driver to the Coax can be Adjusted 0dBm to +6dBm"	1
• Added Storage temperature to the <i>Thermal Information</i>	4
• Change the MIN value of V _{RES} in the ROC table From: 0.84 To: 0.7 V	5
• Change the TYP value of C _C in the ROC table From: 270 To: 220 nF	5
• Changed the <i>Electrical Characteristics</i>	6
• Changed the <i>Switching Characteristics</i>	7
• Added the <i>Typical Characteristics</i> section	8
• Changed the <i>Parameter Measurement Information</i> section	11
• Changed the <i>Application Information</i> section	16

Changes from Original (September 2011) to Revision A

Page

• Changed Pin 4 label (lower right) in the <i>Pin Configuration and Functions</i> diagram from TXIN to RXOUT	3
• Changed the <i>Pin Functions</i> table by merging the DESCRIPTION cells for pins 5, 6, and 7 and deleted the word DIRSET from the beginning of the second line in that description field.	3
• Added rows 162 and 163 to the <i>Electrical Characteristics</i> table, under RECEIVER FILTER section	6
• Added rows 210 and 211 to the <i>Switching Characteristics</i> table	7
• Added Table 1 and Table 2	15
• Added Figure 22 State Transition Diagram	15

6 Pin Configuration and Functions

**RGT (VQFN) Package
16 Pins
Top View**

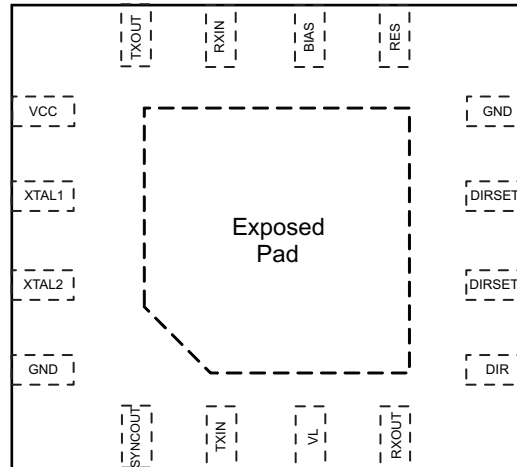

Pin Functions

PIN	HVD62 PIN	DESCRIPTION
	NAME	
1	SYNCOUT	Open drain output to synchronize other devices to the 4x-carrier oscillator at XTAL1,2. (8.704 MHz for HVD62)
2	TXIN	Digital data bit stream to driver.
3	VL	Logic supply voltage for the device.
4	RXOUT	Digital data bit stream from receiver.
5	DIR	DIR: Direction control output signal for bus arbitration.
6	DIRSET2	DIRSET1 and DIRSET2: Bits to set the duration of DIR DIRSET[2,1]:[L,L]=9.6kbps [L,H]=38.4kbps [H,L]=115kbps [H,H]=Standby Mode
7	DIRSET1	
8	GND	Ground
9	RES	Input voltage to adjust driver output power. Set by external resistors from BIAS pin to GND.
10	BIAS	Bias voltage output for setting driver output power by external resistors.
11	RXIN	Modulated input signal to the receiver.
12	TXOUT	Modulated output signal from the driver.
13	VCC	Analog supply voltage for the device.
14	XTAL1	Crystal oscillator's IO pins. Connect a $4 \times f_C$ crystal between these pins. Or connect XTAL1 to an 8.704 MHz clock and connect XTAL2 to GND.
15	XTAL2	
16	GND	Ground
-	EP	Exposed pad. Recommended to be connected to ground plane for best thermal conduction.

7 Specifications

7.1 Absolute Maximum Ratings⁽¹⁾

	VALUES		UNIT
	MIN	MAX	
Supply voltage, V_{CC} and V_L	-0.5	6	V
Voltage range at coax pins	-0.5	6	V
Voltage range at logic pins	-0.3	$V_L + 0.3$	V
Logic Output Current	-20	20	mA
TXOUT output current	Internally limited		
SYNCOUT output current	Internally limited		
Junction Temperature, T_J		170	°C
Storage temperature, T_{STG}	-65	150	
Continuous total power dissipation	See the Thermal Information		°C

- (1) Stresses beyond those listed under “absolute maximum ratings” may cause permanent damage to the device. These are stress ratings only and functional operation of the device at these or any other conditions beyond those indicated under “recommended operating conditions” is not implied. Exposure to absolute-maximum-rated conditions for extended periods may affect device reliability.

7.2 ESD Ratings

	VALUE	UNIT
$V_{(ESD)}$ Electrostatic discharge Human-body model (HBM), per ANSI/ESDA/JEDEC JS-001 ⁽¹⁾	±2000	V

- (1) JEDEC document JEP155 states that 500-V HBM allows safe manufacturing with a standard ESD control process.

7.3 Thermal Information

THERMAL METRIC ⁽¹⁾	SN65HVD62	UNIT
	RGT (VQFN)	
	(16) PINS	
$R_{\theta JA}$ Junction-to-ambient thermal resistance	49.4	°C/W
$R_{\theta Jctop}$ Junction-to-case (top) thermal resistance	64.2	
$R_{\theta JB}$ Junction-to-board thermal resistance	22.9	
Ψ_{JT} Junction-to-top characterization parameter	1.7	
Ψ_{JB} Junction-to-board characterization parameter	22.9	
$R_{\theta Jcbot}$ Junction-to-case (bottom) thermal resistance	25.0	

- (1) For more information about traditional and new thermal metrics, see the *IC Package Thermal Metrics* application report, [SPRA953](#).

7.4 Recommended Operating Conditions

		MIN	NOM	MAX	UNIT		
V _{CC}	Analog supply voltage	3		5.5	V		
V _L	Logic supply voltage	1.6		5.5	V		
V _{I(pp)}	Input signal amplitude at RXIN			1.12	V _{pp}		
V _{IH}	High-level input voltage	TXIN, DIRSET1, DIRSET2		V _L	V		
		XTAL1, XTAL2	70%V _{CC}	V _{CC}			
V _{IL}	Low-level input voltage	TXIN, DIRSET1, DIRSET2	0	30%V _L	V		
		XTAL1, XTAL2	0	30%V _{CC}			
1/t _{UI}	Data signaling rate	9.6		115	kbps		
F _{OSC}	Oscillator frequency		HVD62	–30 ppm	8.704	30 ppm	MHz
T _A	Operating free-air temperature	–40		105		°C	
T _J	Junction Temperature	–40		125		°C	
R _{LOAD}	Load impedance between TXOUT to RXIN		50		Ω		
	Load impedance between RXIN and GND at f _C (channel)		50				
R1	Bias resistor between BIAS and RES		4.1		kΩ		
R2	Bias resistor between RES and GND		10		kΩ		
R _{SYNC}	Pull-up resistor between SYNCOUT and V _{CC}		1		kΩ		
V _{RES}	Voltage at RES pin	0.7		1.5	V		
C _C	Coupling capacitance between RXIN and Coax (channel)		220		nF		
C _{BIAS}	Capacitance between BIAS and GND		1		μF		

7.5 Electrical Characteristics

over recommended operating conditions (unless otherwise noted)

	PARAMETER		TEST CONDITIONS	MIN	TYP	MAX	UNIT
POWER SUPPLY							
100	I_{CC}	Supply current (V_{CC})	TXIN = L (Active)	DIRSET1 = L DIRSET2 = H	28	33	mA
101			TXIN = H (Quiescent)		25	31	
102			TXIN = 115 kbps, 50% duty cycle		27	33	
99			(Standby) DIRSET1 = DIRSET2=H		12	17	
103	I_L	Logic supply current	TXIN = H, RXIN = DC input			50	μ A
104	$\frac{\Delta V_{RXIN}}{\Delta V_{CC}}$	Receiver power supply rejection ratio	$V_{TXIN} = V_L$	45	60		dB
LOGIC PINS							
112	V_{OH}	High-level logic output voltage (RXOUT, DIR)	$I_{OH} = -4$ mA for $V_L > 2.4$ V, $I_{OH} = -2$ mA for $V_L < 2.4$ V	90% V_L			V
113	V_{OL}	Low-level logic output voltage (RXOUT, DIR)	$I_{OL} = 4$ mA for $V_L > 2.4$ V, $I_{OL} = 2$ mA for $V_L < 2.4$ V		10% V_L		V
114	I_{IH}/I_{IL}	Logic input current (DIRSET1/2)		-1		10	μ A
	I_{IH}/I_{IL}	Logic input current (TXIN)		-2		1	μ A
COAX DRIVER							
130	V_{OPP}	Peak-to-peak output voltage at device pin TXOUT (See Figure 19)	$V_{RES} = 1.5$ V (Maximum setting)	2.24	2.5		V_{PP}
132			$V_{RES} = 0.7$ V (Minimum setting)		1.17	1.3	
130A	V_{OPP}	Peak-to-peak voltage at coax out (See Figure 19)	$V_{RES} = 1.5$ V	5	6		dBm
132A			$V_{RES} = 0.7$ V		-0.6	0.3	
134	V_{OZ}	Off-state output voltage	At TXOUT			1	mVpp
134A			At coax out				-60
136		Output emissions	Coupled to coaxial cable with characteristic impedance 50 Ohms, as shown in Figure 1 . With a recommended 470 pF capacitor between RXIN and GND. Measurements above 150 MHz are determined by setup.	Conforms to AISG spectrum emissions mask, 3GPP TS 25.461, see Figure 21			
41	f_o	Output frequency (HVD62)			2.176		MHz
142	Δf	Output frequency variation		-100		100	ppm
143	Z_o	Output impedance	At 100 kHz		0.03		Ω
144			At 10 MHz			3.5	
145	$ I_{OS} $	Short-circuit output current	TXOUT is also protected by a thermal shutdown circuit during short-circuit faults		300	450	mA
COAX RECEIVER							
152	V_{IT}	Input threshold	$f_{IN} = 2.176$ MHz	79	112	158	mVPP
152A				-18	-15	-12	dBm
154	Z_{IN}	Input impedance	$f = f_o$	11	21		k Ω
RECEIVER FILTER							
160	f_{PB}	Passband	$VRXIN = 1.12VP_P$	1.1		4.17	MHz
161	f_{REJ}	Receiver rejection range	2.176MHz carrier amplitude of 112.4 mV _{PP} , Frequency band of spurious components with 800 mVPP allowed.	1.1		4.17	MHz
162	$t_{noise\ filter}$	Receiver noise filter time (slow bit rate)	DIRSET for 9.6kbps		4		μ s
163		Receiver noise filter time (fast bit rate)	DIRSET for > 9.6 kbps		2		
XTAL AND SYNC							
171	I_i	Input leakage current	XTAL1, XTAL2, 0V < $V_{IN} < V_{CC}$	-15		15	μ A
172	V_{OL}	Output low voltage	SYNCOUT, with 1 k Ω resistor from SYNCOUT to V_{CC}			0.4	V

7.6 Switching Characteristics

over recommended operating conditions (unless otherwise noted)

		PARAMETER	TEST CONDITIONS	MIN	TYP	MAX	UNIT
201	t_{pAQ}, t_{pQA}	Coax driver propagation delay	See Figure 19			5	μ s
202	t_r, t_f	Coax receiver output rise/fall time	$C_L = 15$ pF, $R_L = 1$ k Ω , See Figure 19			20	ns
203	t_{PHL}, t_{PLH}	Receiver propagation delay	See Figure 20		5.5	11	μ s
204	Duty Cycle	Coax receiver output duty cycle	$V_{RXIN(ON)} = 630$ mVpp, $V_{RXIN(OFF)} < 5$ mVpp, 50% duty cycle	40%		60%	
214			$V_{RXIN(ON)} = 200$ mVpp, $V_{RXIN(OFF)} < 5$ mVpp, 50% duty cycle	40%		60%	
206	t_{DIR}	Direction control active duration	DIRSET2 = DIRSET1 = GND or OPEN		1667		μ s
207			DIRSET2 = GND, DIRSET1 = VL		417		
208			DIRSET2 = VL, DIRSET1 = VL		137		
209	$t_{DIR\ Skew}$	Direction control skew (DIR to RXOUT)		270			ns
210	t_{DIS}	Standby disable delay	300 mVpp at 2.176 MHz on RXIN		2		ms
211	t_{EN}	Standby enable delay			2		

7.7 Typical Characteristics

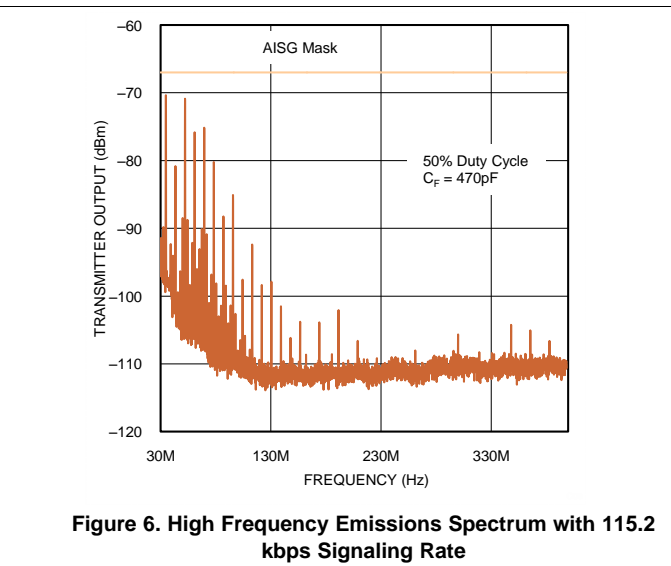
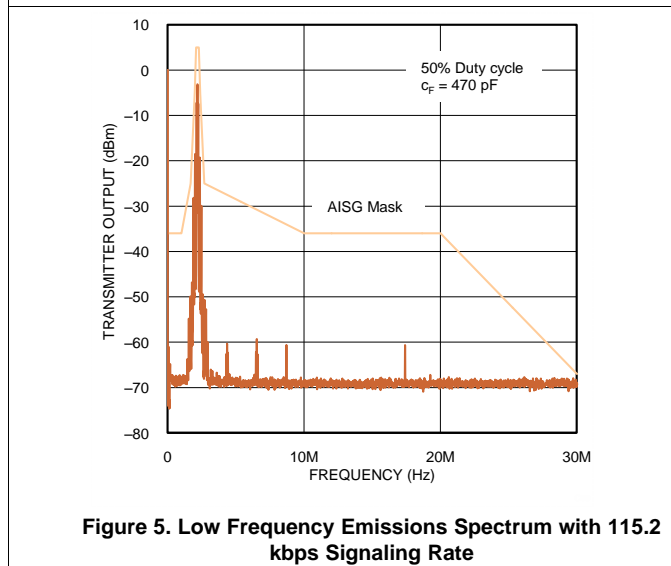
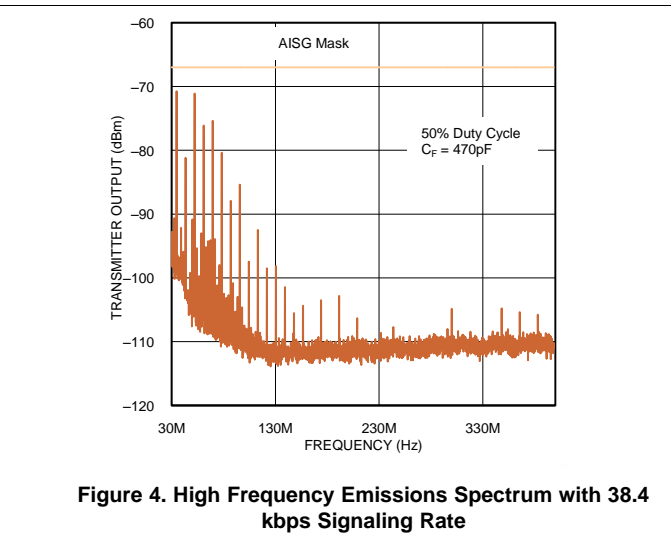
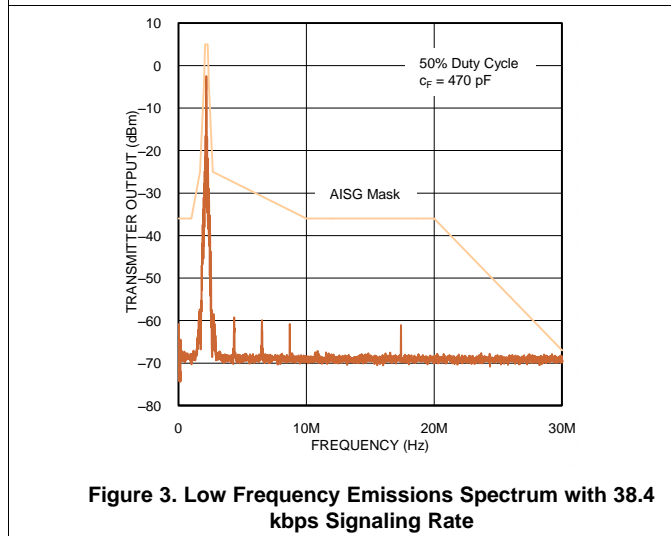
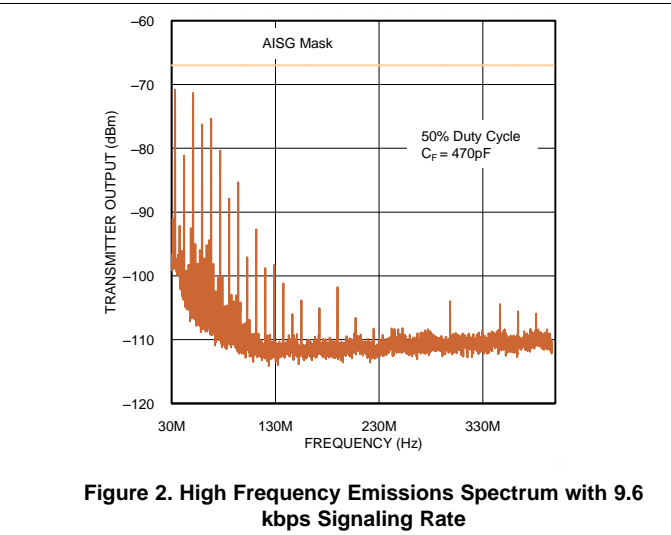
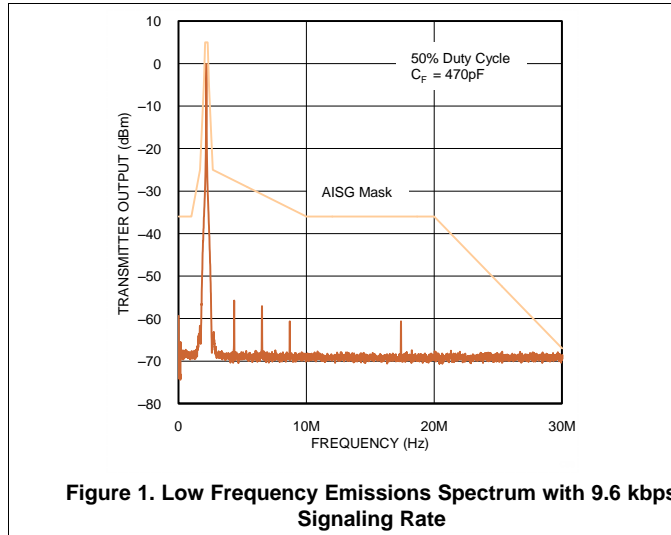

Typical Characteristics (continued)

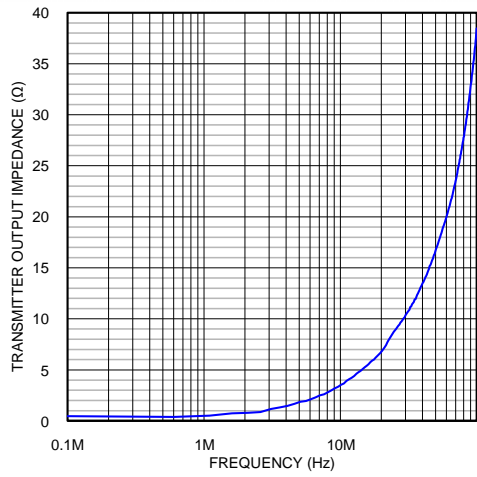

Figure 7. Transmitter Output Impedance

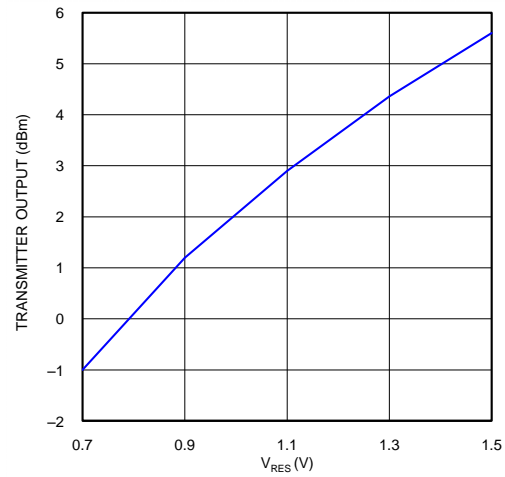

Figure 8. Transmit Power Adjustment

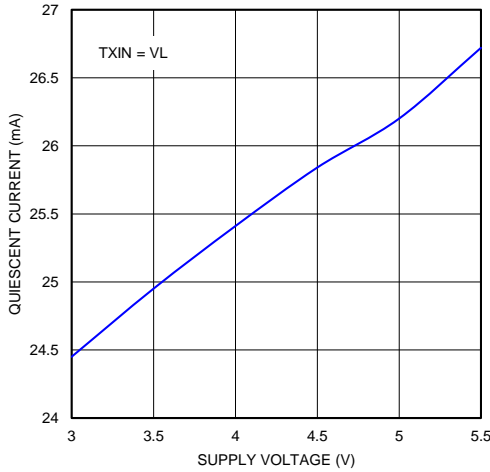

Figure 9. Supply Current versus Supply Voltage while Transmitting

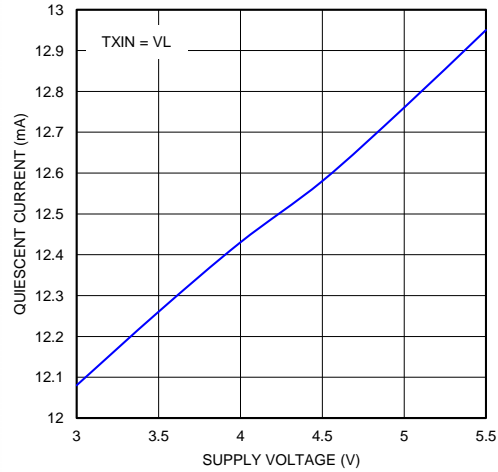

Figure 10. Supply Current versus Supply Voltage in Standby Mode

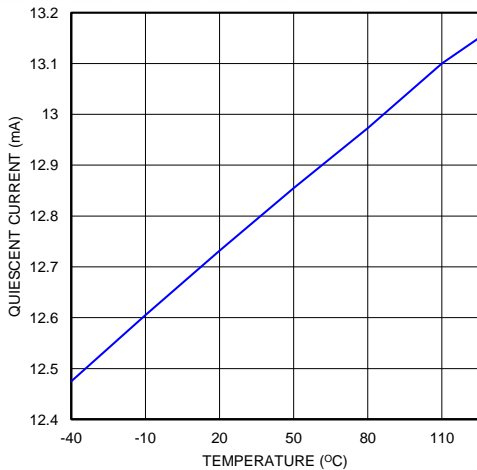

Figure 11. Supply Current versus Temperature in Standby Mode

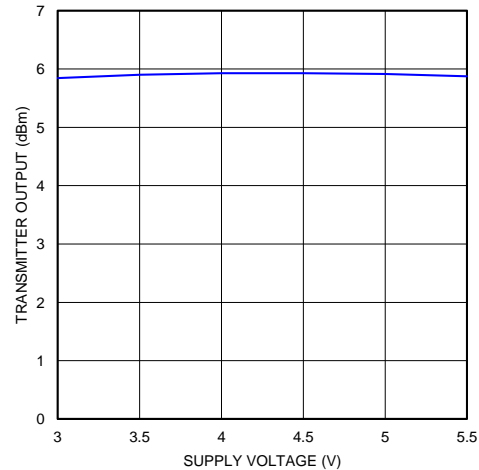

Figure 12. Transmitter Output Power versus Supply Voltage

Typical Characteristics (continued)

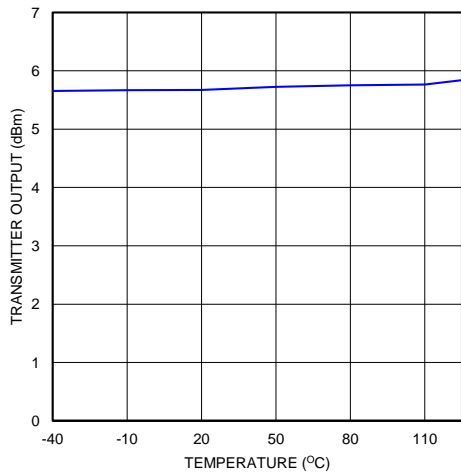

Figure 13. Transmitter Output Power versus Temperature

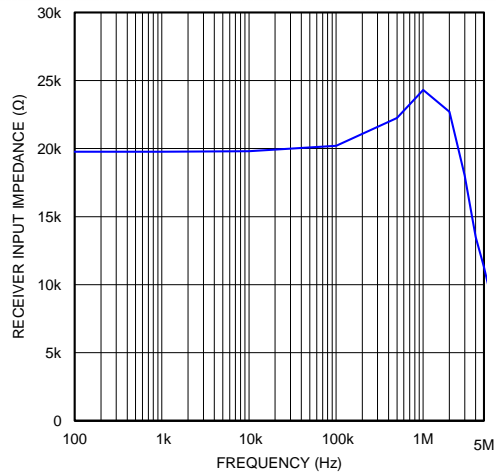

Figure 14. Receiver Input Impedance versus Frequency

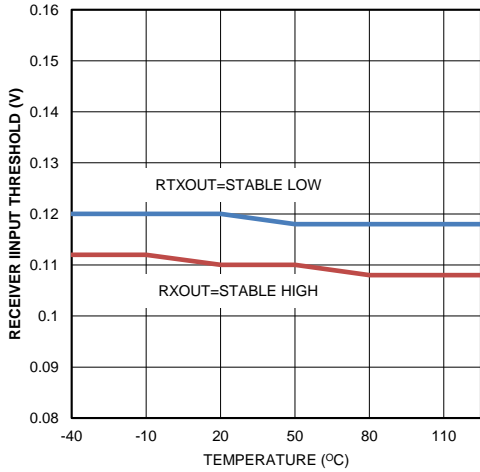

Figure 15. Receiver Input Threshold versus Temperature

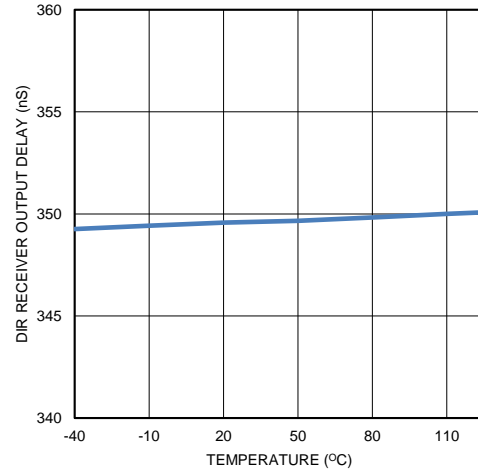

Figure 16. DIR Output Delay versus Temperature

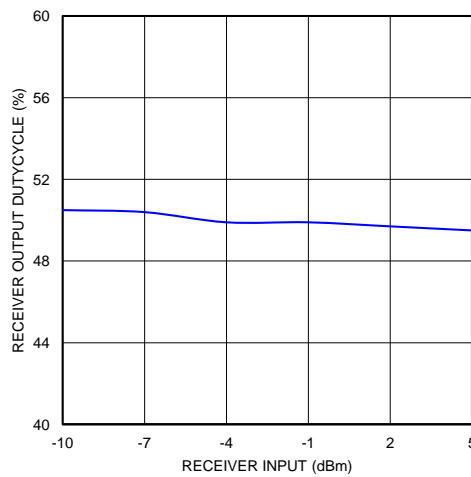

Figure 17. Receiver Duty Cycle with 9.6 kbps Signaling Rate

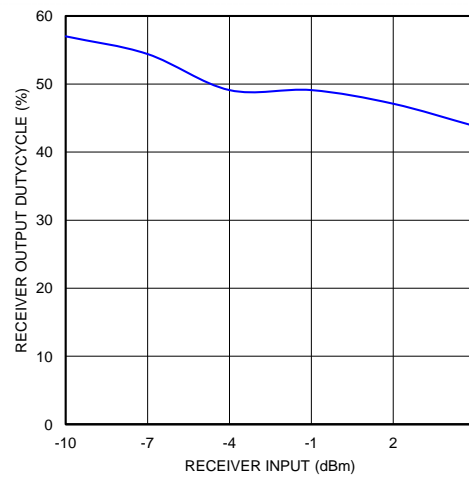

Figure 18. Receiver Duty Cycle with 115.2 kbps Signaling Rate

8 Parameter Measurement Information

Signal generator rate is 115 kbps, 50% duty cycle, rise and fall times less than 6 nsec, nominal output levels 0V and 3V. Coupling capacitor C_c is 220 nF.

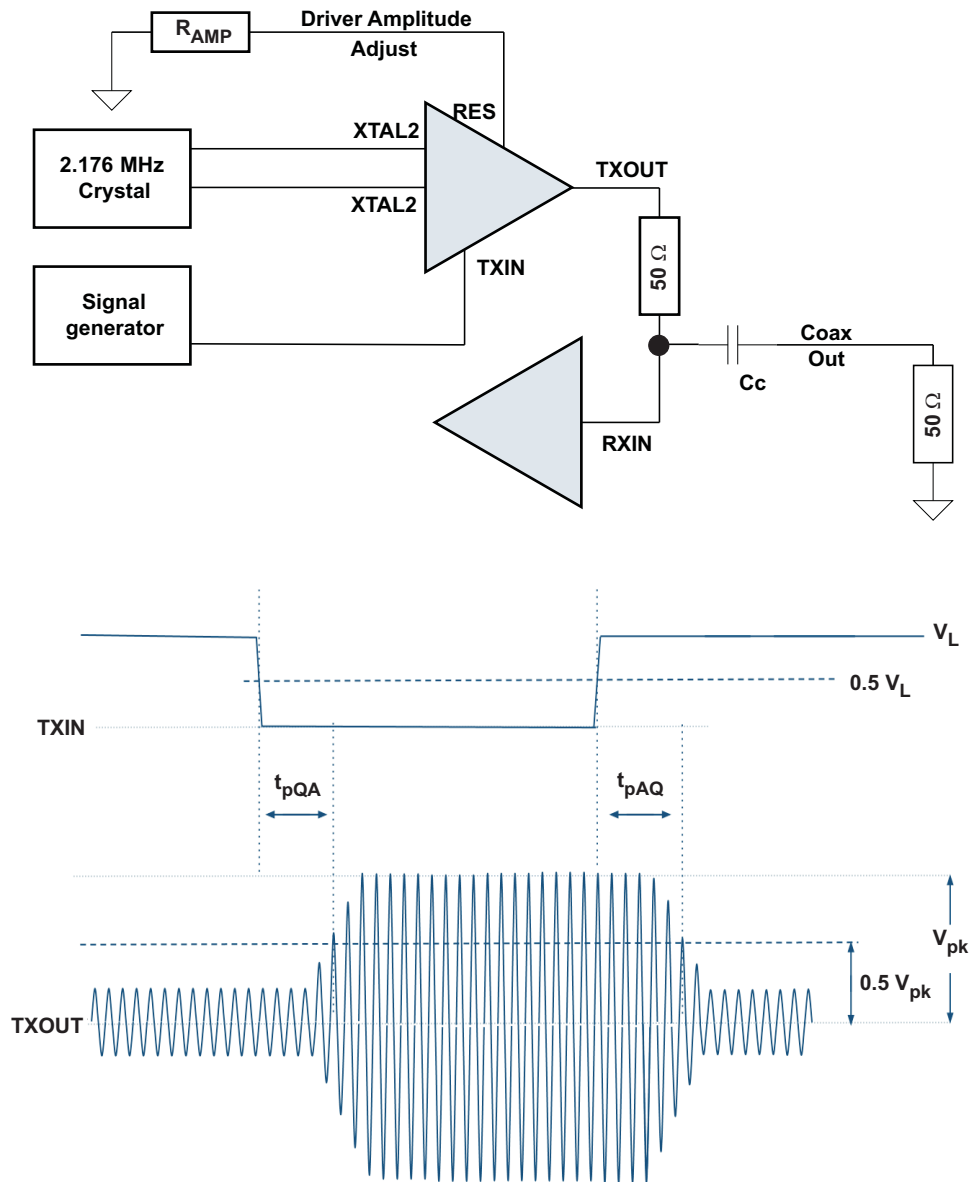

Figure 19. Measurement of Modem Driver Output Voltage With 50 Ω Loads

Parameter Measurement Information (continued)

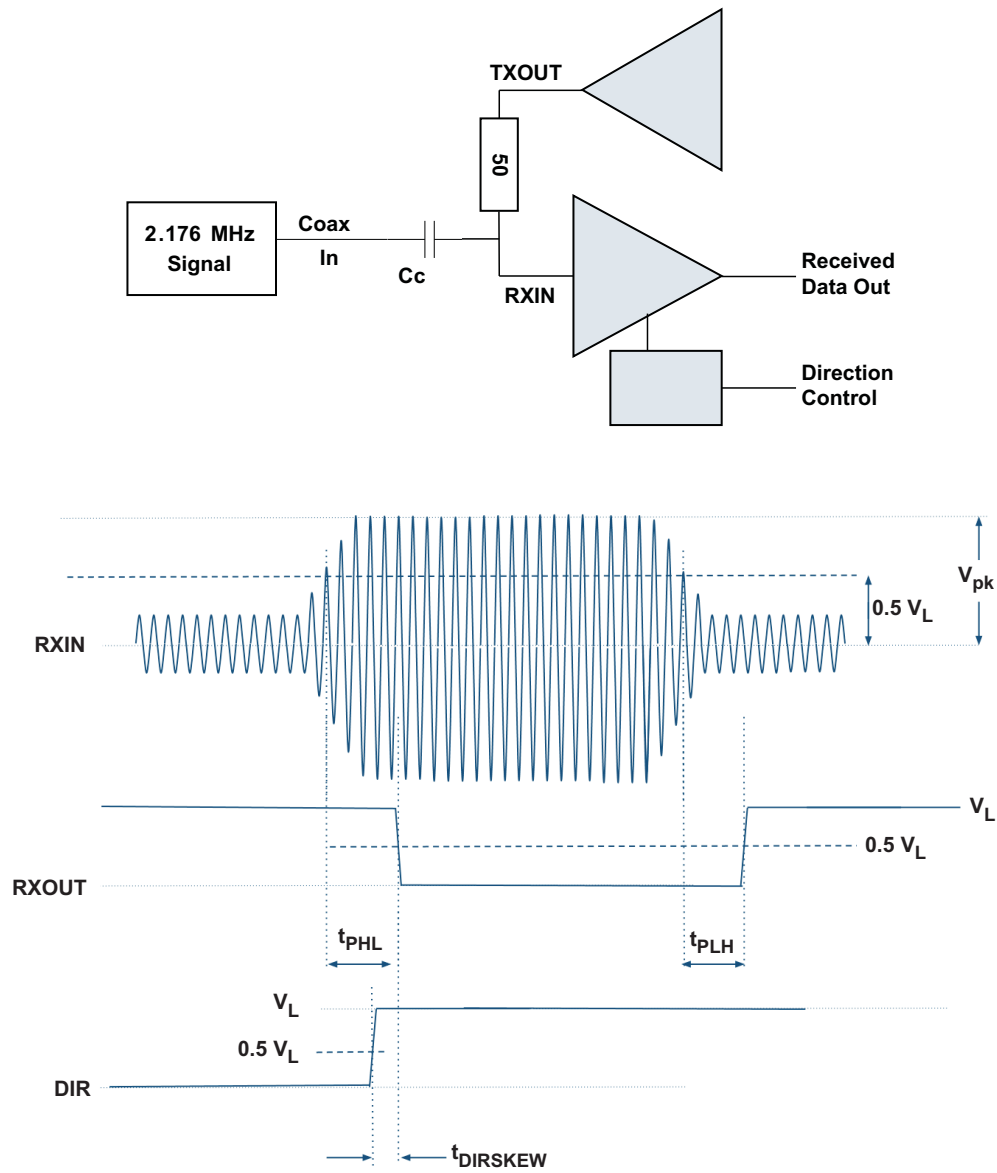

Figure 20. Measurement of Modem Receiver Propagation Delays

Parameter Measurement Information (continued)

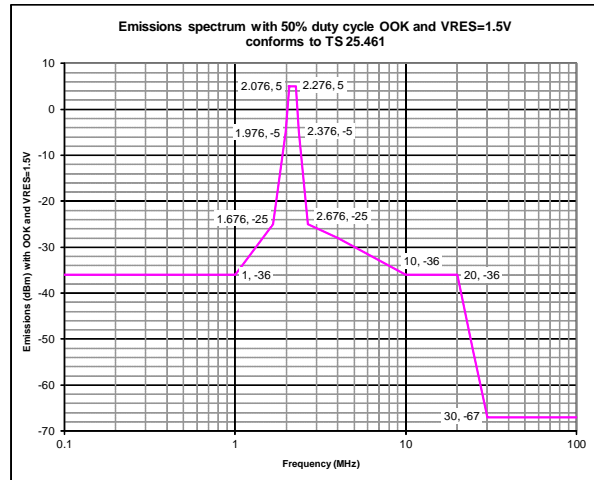

Figure 21. AISG Emissions Template

9 Detailed Description

9.1 Overview

If DIRSET1 and DIRSET2 are in a logic High state, the device will be in STANDBY mode. While in STANDBY mode, the Receiver functions normally, detecting carrier frequency activity on the RXIN pin and setting the RXOUT state as discussed below. But the Transmitter circuits are not active in STANDBY, thus the TXOUT pin is idle regardless of the logic state of TXIN. The supply current in STANDBY mode is significantly reduced, allowing power savings when the node is not transmitting.

9.2 Functional Block Diagram

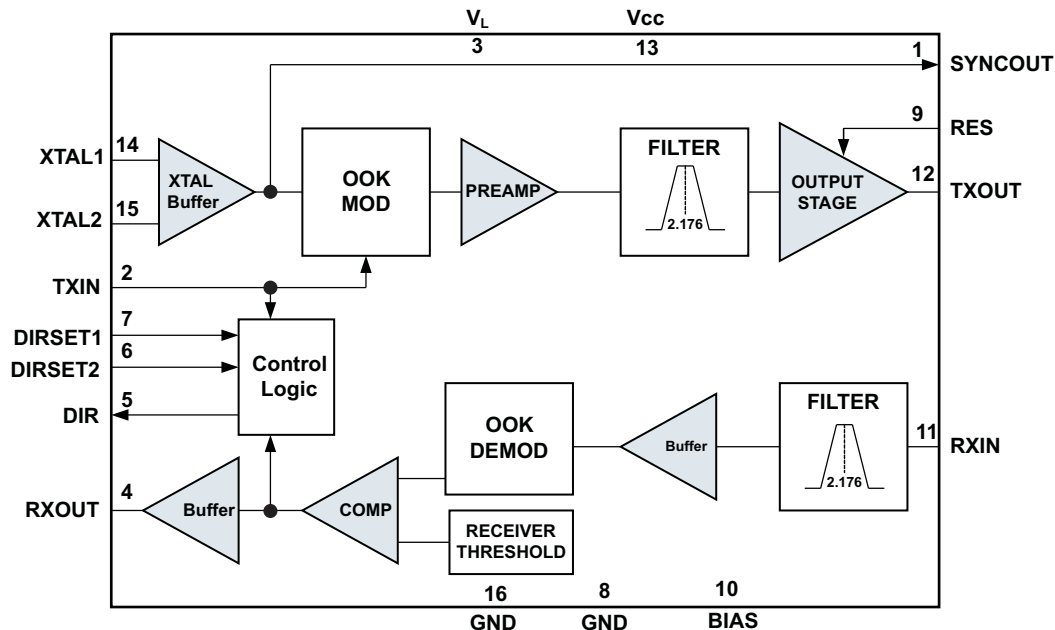

9.3 Device Functional Modes

When not in STANDBY mode, the default power-on state is IDLE. When in IDLE mode, RXOUT is High, and TXOUT is quiet. The device transitions to RECEIVE mode when a valid modulated signal is detected on the RXIN line <OR> the device transitions to TRANSMIT mode when TXIN goes Low. The device stays in either RECEIVE or TRANSMIT mode until DIR Timeout (nominal 16 bit times) after the last activity on RXOUT or TXIN.

When in RECEIVE mode:

- RXOUT responds to all valid modulated signals on RXIN, whether from the local transmitter, a remote transmitter, or long noise burst.
- TXOUT responds to TXIN, generating 2.176 MHz signals on TXOUT when TXIN is Low, and TXOUT is quiet when TXIN is High. (In normal operation, TXIN is expected to remain High when the device is in RECEIVE mode).
- The device stays in RECEIVE mode until 16 bit times after the last rising edge on RXOUT, caused by valid modulated signal on the RXIN line.

When in TRANSMIT mode:

- RXOUT stays High, regardless of the input signal on RXIN.
- TXOUT responds to TXIN, generating 2.176 MHz signals on TXOUT when TXIN is Low, and TXOUT is quiet when TXIN is High.
- The device stays in TRANSMIT mode until 16 bit times after TXIN goes High.

Device Functional Modes (continued)

Table 1. Driver Function Table⁽¹⁾

TXIN	[DIRSET1, DIRSET2]	TXOUT	COMMENT
H	[L,L], [L,H] or [H,L]	< 1 mV _{pp} at 2.176 MHz	Driver not active
L		V _{OPP} at 2.176 MHz	Driver active
X	[H,H]	< 1 mV _{pp} at 2.176 MHz	Standby mode

(1) H = High, L = Low, X = Indeterminate

Table 2. Receiver and DIR Function Table⁽¹⁾

RXIN	RXOUT	DIR	COMMENT (see Figure 22)
IDLE mode (not transmitting or receiving)			
< V _{IT} at 2.176 MHz for longer than DIR timeout	H	L	No outgoing or incoming signal
RECEIVE mode (not already transmitting)			
< V _{IT} at 2.176 MHz for less than t _{DIR} Timeout	H	H	Incoming '1' bit, DIR stays HIGH for DIR Timeout
> V _{IT} at 2.176 MHz for longer than t _{noise filter}	L	H	Incoming '0' bit, DIR output is HIGH
TRANSMIT mode (not already receiving)			
X	H	L	Outgoing message, DIR stays LOW for DIR Timeout

(1) H = High, L = Low

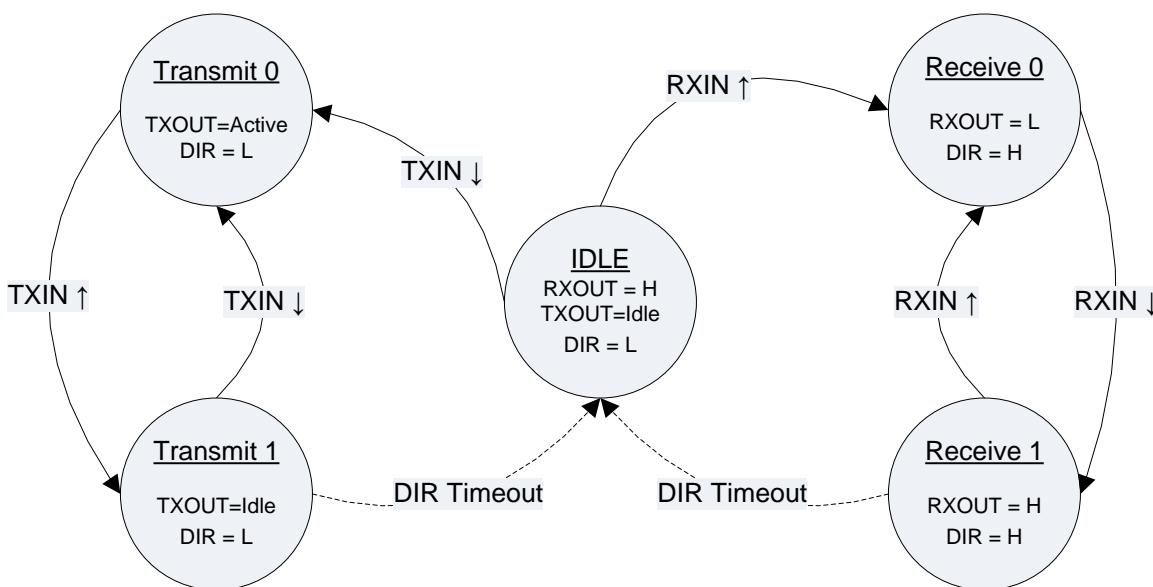

Figure 22. State Transition Diagram

10 Application and Implementation

NOTE

Information in the following applications sections is not part of the TI component specification, and TI does not warrant its accuracy or completeness. TI's customers are responsible for determining suitability of components for their purposes. Customers should validate and test their design implementation to confirm system functionality.

10.1 Application Information

10.1.1 Driver Amplitude Adjust

The SN65HVD62 can provide up to 2.5 V peak-to-peak of output signal at the TXOUT pin to compensate for potential loss within the external filter, cable, connections, and termination. External resistors are used to set the amplitude of the modulated driver output signal. Resistors connected across RES and BIAS set the output amplitude. The maximum peak-to-peak voltage at TXOUT is 2.5 V, corresponding to +6 dBm on the coaxial cable. The TXOUT voltage level can be adjusted by choice of resistors to set the voltage at the RES pin, according to the following equation:

$$V_{TXOUT} (V_{P-P}) = (2.5 V_{P-P} \times V_{RES} (V)) / 1.5 V \quad V_{RES} (V) = 1.5 V \times R2 / (R1 + R2) \quad V_{TXOUT} (V_{P-P}) = 2.5 V_{P-P} \times R2 / (R1 + R2). \quad (1)$$

The voltage at the RES pin should be between 0.7 V and 1.5 V. Connect RES directly to the BIAS ($R1 = 0 \Omega$) for maximum output level of 2.5 V peak-to-peak. This gives a minimum voltage level at TXOUT of 1.2 V peak-to-peak, corresponding to about 0 dBm at the coaxial cable. A 1 μ F capacitor should be connected between the BIAS pin and GND. To obtain a nominal power level of +3 dBm at the feeder cable as the AISG standard requires, use $R1 = 4.1k \Omega$ and $R2 = 10k \Omega$ that provide 1.78 V_{P-P} at TXOUT.

10.1.2 Direction Control

In many applications the mast-top modem which receives data from the base will then distribute the received data through an RS-485 network to several mast-top devices. When the mast-top modem receives the first logic 0 bit (active modulated signal) it will take control of the mast-top RS-485 network by asserting the Direction Control signal. The duration of the Direction Control assertion should be optimized to pass a complete message of length B bits at the known signaling rate ($1/t_{BIT}$) before relinquishing control of the mast-top RS-485 network. For example, if the messages are 10 bits in length ($B=10$) and the signaling rate is 9600 bits per second ($t_{BIT} = 0.104$ msec) then a positive pulse of duration 1.7 msec is sufficient (with margin to allow for network propagation delays) to enable the mast-top RS-485 drivers to distribute each received message.

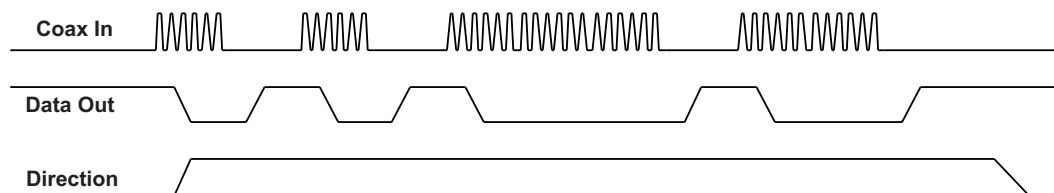

10.1.3 Direction Control Time Constant

The time constant for the Direction Control function can be set by the Control Mode pins, DIRSET1/DIRSET2. These pins should be set to correspond to the desired data rate. With no external connections to the Control Mode pins, the internal time constant is set to the maximum value, corresponding to the minimum data rate.

Application Information (continued)

10.1.4 Conversion Between dBm and Peak-to-peak Voltage

$$\text{dBm} = 20 \times \text{LOG}_{10} [\text{Volts-pp} / \text{SQRT}(0.008 \times Z_o)] = 20 \times \text{LOG}_{10} [\text{Volts-pp} / 0.63] \text{ for } Z_o = 50 \Omega \quad (2)$$

$$\text{Volts-pp} = \text{SQRT}(0.008 \times Z_o) \times 10^{(\text{dBm}/20)} = 0.63 \times 10^{(\text{dBm}/20)} \text{ for } Z_o = 50 \Omega \quad (3)$$

The following table shows conversions between dBm and peak-to-peak voltage with 50 Ω load, for various levels of interest including reference levels from the 3GPP TS 25.461 Technical Specification.

SIGNAL ON COAX (luant Layer 1)	dBm	Vpp (V)
Maximum Driver ON Signal	5	1.12
Nominal Driver ON Signal	3	0.89
Minimum Driver ON Signal	1	0.71
AISG Maximum Receiver Threshold	-12	0.16
Nominal Receiver Threshold	-15	0.11
Minimum Receiver Threshold	-18	0.08
Maximum Driver OFF Signal	-40	0.006

11 Device and Documentation Support

11.1 Documentation Support

11.2 Trademarks

All trademarks are the property of their respective owners.

11.3 Electrostatic Discharge Caution



These devices have limited built-in ESD protection. The leads should be shorted together or the device placed in conductive foam during storage or handling to prevent electrostatic damage to the MOS gates.

11.4 Glossary

[SLYZ022](#) — *TI Glossary*.

This glossary lists and explains terms, acronyms, and definitions.

12 Mechanical, Packaging, and Orderable Information

The following pages include mechanical, packaging, and orderable information. This information is the most current data available for the designated devices. This data is subject to change without notice and revision of this document. For browser-based versions of this data sheet, refer to the left-hand navigation.

PACKAGING INFORMATION

Orderable Device	Status (1)	Package Type	Package Drawing	Pins	Package Qty	Eco Plan (2)	Lead/Ball Finish (6)	MSL Peak Temp (3)	Op Temp (°C)	Device Marking (4/5)	Samples
SN65HVD62RGTR	ACTIVE	VQFN	RGT	16	3000	Green (RoHS & no Sb/Br)	CU NIPDAU	Level-2-260C-1 YEAR	-40 to 105	HVD62	Samples
SN65HVD62RGTT	ACTIVE	VQFN	RGT	16	250	Green (RoHS & no Sb/Br)	CU NIPDAU	Level-2-260C-1 YEAR	-40 to 105	HVD62	Samples

(1) The marketing status values are defined as follows:

ACTIVE: Product device recommended for new designs.

LIFEBUY: TI has announced that the device will be discontinued, and a lifetime-buy period is in effect.

NRND: Not recommended for new designs. Device is in production to support existing customers, but TI does not recommend using this part in a new design.

PREVIEW: Device has been announced but is not in production. Samples may or may not be available.

OBsolete: TI has discontinued the production of the device.

(2) **RoHS:** TI defines "RoHS" to mean semiconductor products that are compliant with the current EU RoHS requirements for all 10 RoHS substances, including the requirement that RoHS substance do not exceed 0.1% by weight in homogeneous materials. Where designed to be soldered at high temperatures, "RoHS" products are suitable for use in specified lead-free processes. TI may reference these types of products as "Pb-Free".

RoHS Exempt: TI defines "RoHS Exempt" to mean products that contain lead but are compliant with EU RoHS pursuant to a specific EU RoHS exemption.

Green: TI defines "Green" to mean the content of Chlorine (Cl) and Bromine (Br) based flame retardants meet JS709B low halogen requirements of <=1000ppm threshold. Antimony trioxide based flame retardants must also meet the <=1000ppm threshold requirement.

(3) MSL, Peak Temp. - The Moisture Sensitivity Level rating according to the JEDEC industry standard classifications, and peak solder temperature.

(4) There may be additional marking, which relates to the logo, the lot trace code information, or the environmental category on the device.

(5) Multiple Device Markings will be inside parentheses. Only one Device Marking contained in parentheses and separated by a "~" will appear on a device. If a line is indented then it is a continuation of the previous line and the two combined represent the entire Device Marking for that device.

(6) Lead/Ball Finish - Orderable Devices may have multiple material finish options. Finish options are separated by a vertical ruled line. Lead/Ball Finish values may wrap to two lines if the finish value exceeds the maximum column width.

Important Information and Disclaimer:The information provided on this page represents TI's knowledge and belief as of the date that it is provided. TI bases its knowledge and belief on information provided by third parties, and makes no representation or warranty as to the accuracy of such information. Efforts are underway to better integrate information from third parties. TI has taken and continues to take reasonable steps to provide representative and accurate information but may not have conducted destructive testing or chemical analysis on incoming materials and chemicals. TI and TI suppliers consider certain information to be proprietary, and thus CAS numbers and other limited information may not be available for release.

In no event shall TI's liability arising out of such information exceed the total purchase price of the TI part(s) at issue in this document sold by TI to Customer on an annual basis.

TAPE AND REEL INFORMATION



QUADRANT ASSIGNMENTS FOR PIN 1 ORIENTATION IN TAPE



*All dimensions are nominal

Device	Package Type	Package Drawing	Pins	SPQ	Reel Diameter (mm)	Reel Width W1 (mm)	A0 (mm)	B0 (mm)	K0 (mm)	P1 (mm)	W (mm)	Pin1 Quadrant
SN65HVD62RGTR	VQFN	RGT	16	3000	330.0	12.4	3.3	3.3	1.1	8.0	12.0	Q2
SN65HVD62RGTT	VQFN	RGT	16	250	180.0	12.4	3.3	3.3	1.1	8.0	12.0	Q2

TAPE AND REEL BOX DIMENSIONS



*All dimensions are nominal

Device	Package Type	Package Drawing	Pins	SPQ	Length (mm)	Width (mm)	Height (mm)
SN65HVD62RGTR	VQFN	RGT	16	3000	367.0	367.0	35.0
SN65HVD62RGTT	VQFN	RGT	16	250	210.0	185.0	35.0

RGT 16

GENERIC PACKAGE VIEW

VQFN - 1 mm max height

PLASTIC QUAD FLATPACK - NO LEAD

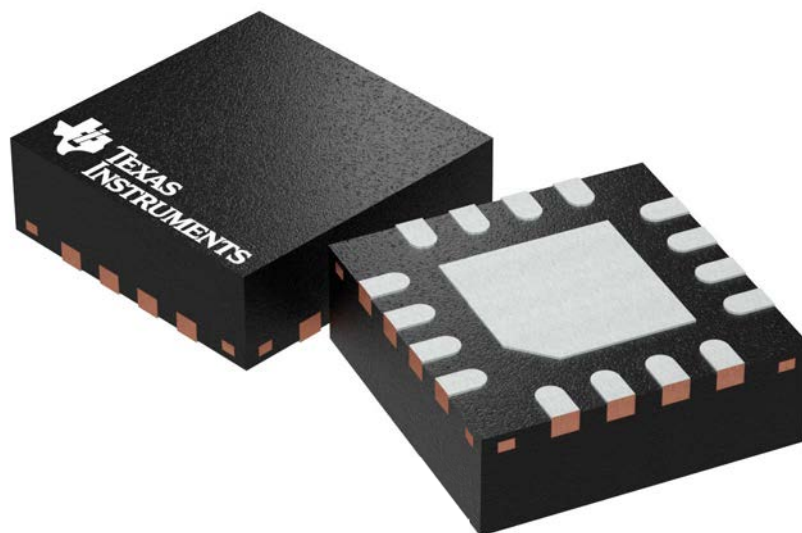

Images above are just a representation of the package family, actual package may vary.
Refer to the product data sheet for package details.

4203495/1

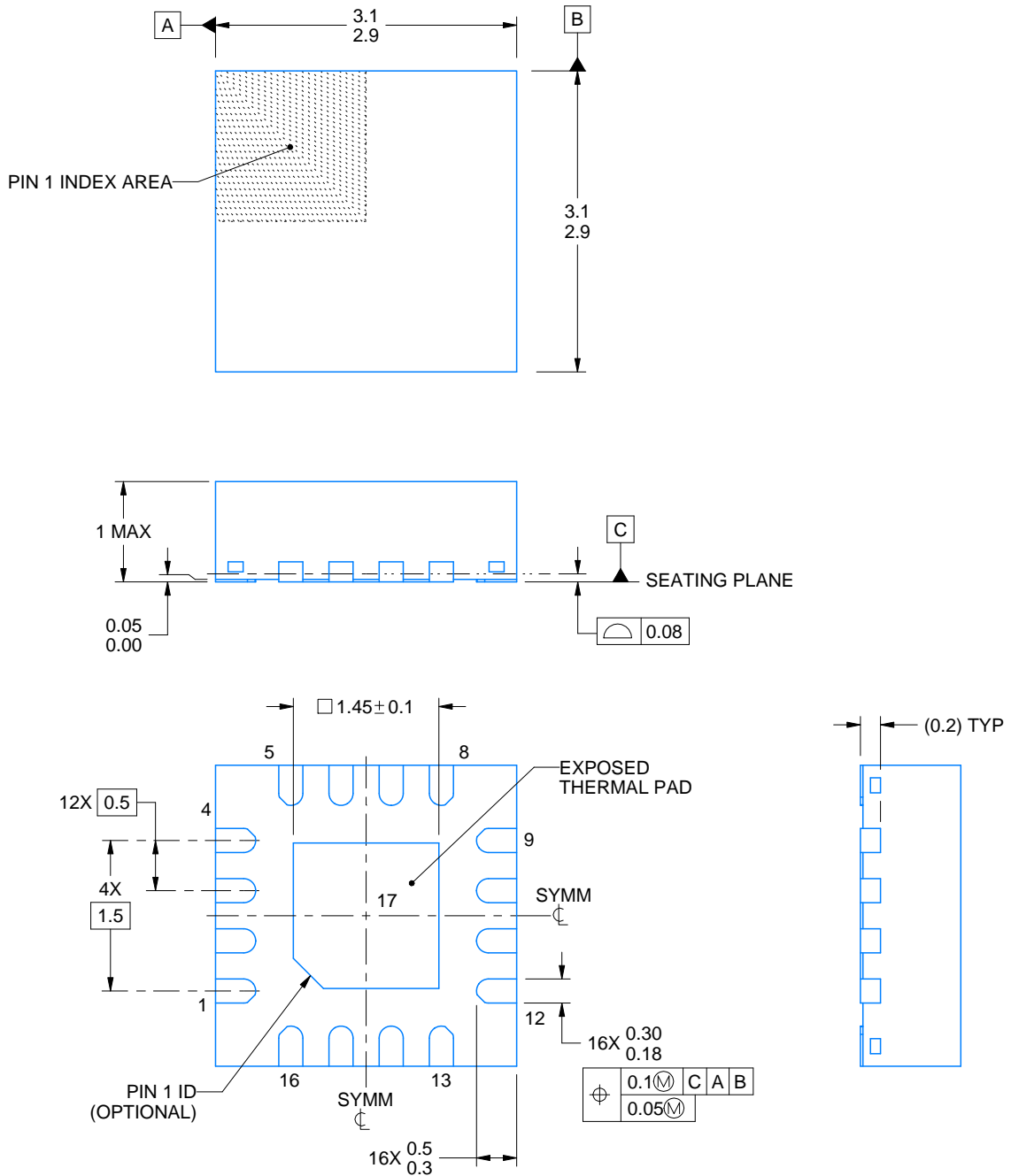
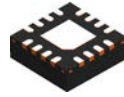

4219032/A 02/2017

NOTES:

1. All linear dimensions are in millimeters. Any dimensions in parenthesis are for reference only. Dimensioning and tolerancing per ASME Y14.5M.
2. This drawing is subject to change without notice.
3. The package thermal pad must be soldered to the printed circuit board for thermal and mechanical performance.
4. Reference JEDEC registration MO-220

EXAMPLE STENCIL DESIGN

RGT0016A

VQFN - 1 mm max height

PLASTIC QUAD FLATPACK - NO LEAD

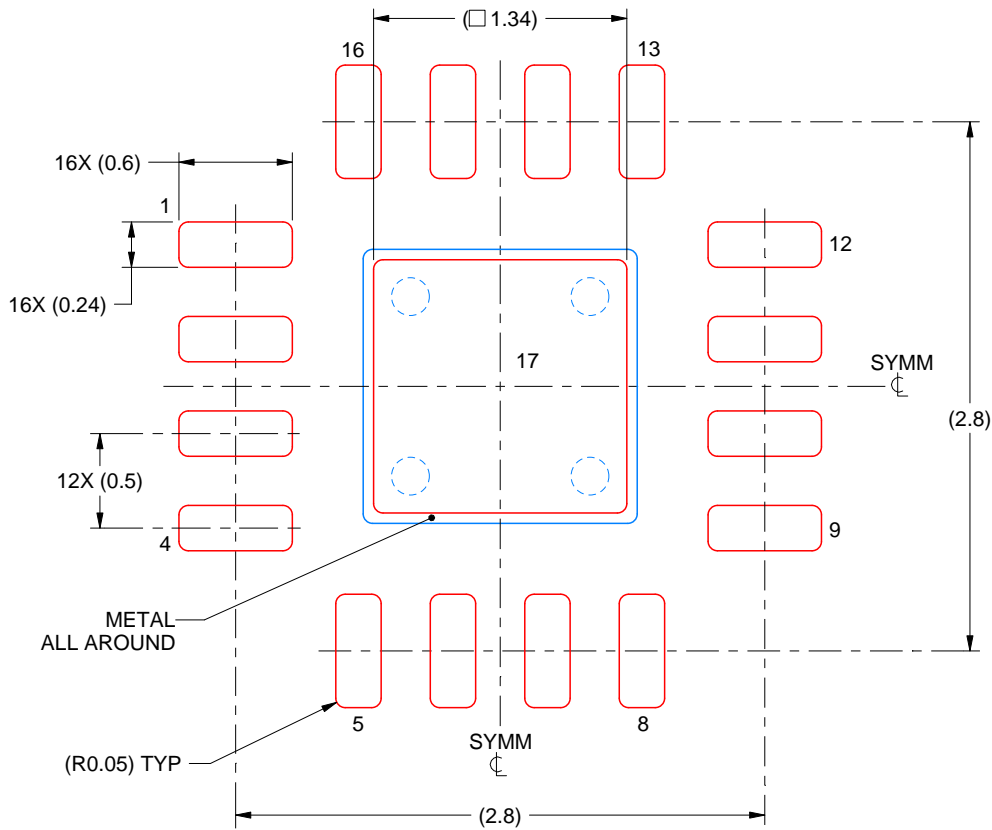

SOLDER PASTE EXAMPLE
BASED ON 0.125 mm THICK STENCIL

EXPOSED PAD 17:
86% PRINTED SOLDER COVERAGE BY AREA UNDER PACKAGE
SCALE:25X

4219032/A 02/2017

NOTES: (continued)

7. Laser cutting apertures with trapezoidal walls and rounded corners may offer better paste release. IPC-7525 may have alternate design recommendations.

IMPORTANT NOTICE AND DISCLAIMER

TI PROVIDES TECHNICAL AND RELIABILITY DATA (INCLUDING DATASHEETS), DESIGN RESOURCES (INCLUDING REFERENCE DESIGNS), APPLICATION OR OTHER DESIGN ADVICE, WEB TOOLS, SAFETY INFORMATION, AND OTHER RESOURCES "AS IS" AND WITH ALL FAULTS, AND DISCLAIMS ALL WARRANTIES, EXPRESS AND IMPLIED, INCLUDING WITHOUT LIMITATION ANY IMPLIED WARRANTIES OF MERCHANTABILITY, FITNESS FOR A PARTICULAR PURPOSE OR NON-INFRINGEMENT OF THIRD PARTY INTELLECTUAL PROPERTY RIGHTS.

These resources are intended for skilled developers designing with TI products. You are solely responsible for (1) selecting the appropriate TI products for your application, (2) designing, validating and testing your application, and (3) ensuring your application meets applicable standards, and any other safety, security, or other requirements. These resources are subject to change without notice. TI grants you permission to use these resources only for development of an application that uses the TI products described in the resource. Other reproduction and display of these resources is prohibited. No license is granted to any other TI intellectual property right or to any third party intellectual property right. TI disclaims responsibility for, and you will fully indemnify TI and its representatives against, any claims, damages, costs, losses, and liabilities arising out of your use of these resources.

TI's products are provided subject to TI's Terms of Sale (www.ti.com/legal/termsofsale.html) or other applicable terms available either on ti.com or provided in conjunction with such TI products. TI's provision of these resources does not expand or otherwise alter TI's applicable warranties or warranty disclaimers for TI products.

Mailing Address: Texas Instruments, Post Office Box 655303, Dallas, Texas 75265
Copyright © 2019, Texas Instruments Incorporated

Looking for pricing, stock, or lifecycle information?

Click below to explore more details on WIN SOURCE:

 [View SN65HVD62RGTR on WIN SOURCE](#)

 [Texas Instruments](#) Information

Optimize Your Supply Chain with WIN SOURCE Solutions

-  Global Sourcing Solution
-  Obsolete Management
-  Cost Control Management
-  Shortage Management
-  Alternative Solution
-  Excess Inventory Management