

74F573

Octal D-Type Latch with 3-STATE Outputs

General Description

The 74F573 is a high speed octal latch with buffered common Latch Enable (LE) and buffered common Output Enable (\overline{OE}) inputs.

This device is functionally identical to the 74F373 but has different pinouts.

Features

- Inputs and outputs on opposite sides of package allowing easy interface with microprocessors
- Useful as input or output port for microprocessors
- Functionally identical to 74F373
- 3-STATE outputs for bus interfacing
- Guaranteed 4000V minimum ESD protection

Ordering Code:

| Order Number | Package Number | Package Description |
|--------------|----------------|---|
| 74F573SC | M20B | 20-Lead Small Outline Integrated Circuit (SOIC), JEDEC MS-013, 0.300 Wide |
| 74F573SJ | M20D | 20-Lead Small Outline Package (SOP), EIAJ TYPE II, 5.3mm Wide |
| 74F573PC | N20A | 20-Lead Plastic Dual-In-Line Package (PDIP), JEDEC MS-001, 0.300 Wide |

Devices also available in Tape and Reel. Specify by appending the suffix letter "X" to the ordering code.

Logic Symbols

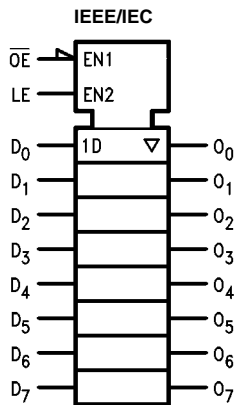
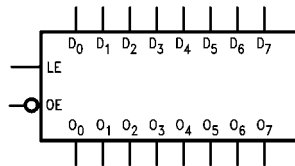

Connection Diagram

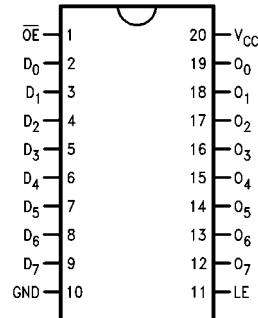

Unit Loading/Fan Out

| Pin Names | Description | U.L. HIGH/LOW | Input I_{IH}/I_{IL} Output I_{OH}/I_{OL} |
|--------------------------------|--|------------------|---|
| D ₀ -D ₇ | Data Inputs | 1.0/1.0 | 20 μ A/-0.6 mA |
| LE | Latch Enable Input (Active HIGH) | 1.0/1.0 | 20 μ A/-0.6 mA |
| \overline{OE} | 3-STATE Output Enable Input (Active LOW) | 1.0/1.0 | 20 μ A/-0.6 mA |
| O ₀ -O ₇ | 3-STATE Latch Outputs | 150/40(33.3) | -3 mA/24 mA (20 mA) |

Functional Description

The 74F573 contains eight D-type latches with 3-state output buffers. When the Latch Enable (LE) input is HIGH, data on the D_n inputs enters the latches. In this condition the latches are transparent, i.e., a latch output will change state each time its D input changes. When LE is LOW the latches store the information that was present on the D inputs a setup time preceding the HIGH-to-LOW transition of LE. The 3-state buffers are controlled by the Output Enable (\overline{OE}) input. When \overline{OE} is LOW, the buffers are in the bi-state mode. When \overline{OE} is HIGH the buffers are in the high impedance mode but this does not interfere with entering new data into the latches.

Function Table

| Inputs | | | Outputs |
|-----------------|----|---|----------------|
| \overline{OE} | LE | D | O |
| L | H | H | H |
| L | H | L | L |
| L | L | X | O ₀ |
| H | X | X | Z |

H = HIGH Voltage Level
L = LOW Voltage Level
X = Immaterial
O₀ = Value stored from previous clock cycle

Logic Diagram

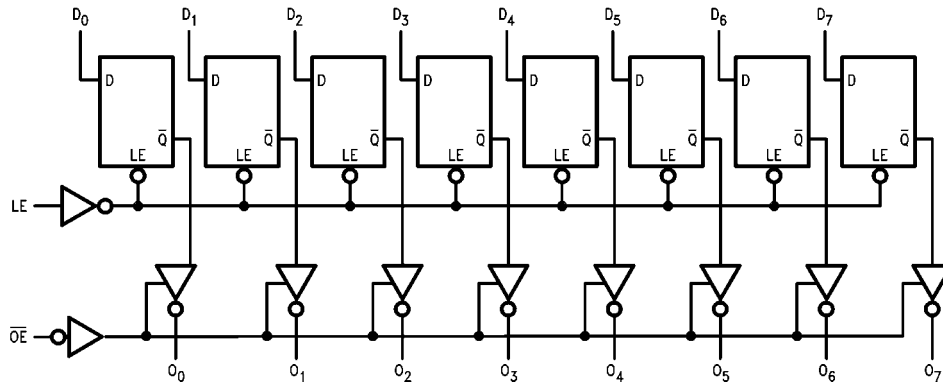

Please note that this diagram is provided only for the understanding of logic operations and should not be used to estimate propagation delays.

Absolute Maximum Ratings(Note 1)

| | |
|--|--------------------------------------|
| Storage Temperature | -65°C to +150°C |
| Ambient Temperature under Bias | -55°C to +125°C |
| Junction Temperature under Bias | -55°C to +150°C |
| V _{CC} Pin Potential to Ground Pin | -0.5V to +7.0V |
| Input Voltage (Note 2) | -0.5V to +7.0V |
| Input Current (Note 2) | -30 mA to +5.0 mA |
| Voltage Applied to Output in HIGH State (with V _{CC} = 0V) | |
| Standard Output | -0.5V to V _{CC} |
| 3-STATE Output | -0.5V to +5.5V |
| Current Applied to Output in LOW State (Max) | twice the rated I _{OL} (mA) |
| ESD Last Passing Voltage (Min) | 4000V |

Recommended Operating Conditions

| | |
|------------------------------|----------------|
| Free Air Ambient Temperature | 0°C to +70°C |
| Supply Voltage | +4.5V to +5.5V |

Note 1: Absolute maximum ratings are values beyond which the device may be damaged or have its useful life impaired. Functional operation under these conditions is not implied.

Note 2: Either voltage limit or current limit is sufficient to protect inputs.

DC Electrical Characteristics

| Symbol | Parameter | Min | Typ | Max | Units | V _{CC} | Conditions |
|------------------|-----------------------------------|--|--------------------------|-------------|-------|-----------------|--|
| V _{IH} | Input HIGH Voltage | 2.0 | | | V | | Recognized as a HIGH Signal |
| V _{IL} | Input LOW Voltage | | | 0.8 | V | | Recognized as a LOW Signal |
| V _{CD} | Input Clamp Diode Voltage | | | -1.2 | V | Min | I _{IN} = -18 mA |
| V _{OH} | Output HIGH Voltage | 10% V _{CC} 10% V _{CC} 5% V _{CC} 5% V _{CC} | 2.5 2.4 2.7 2.7 | | V | Min | I _{OH} = -1 mA I _{OH} = -3 mA I _{OH} = -1 mA I _{OH} = -3 mA |
| V _{OL} | Output LOW Voltage | 10% V _{CC} | | 0.5 | V | Min | I _{OL} = 24 mA |
| I _{IH} | Input HIGH Current | | | 20.0 5.0 | μA | Max | V _{IN} = 2.7V |
| I _{BVI} | Input HIGH Current Breakdown Test | | | 7.0 | μA | Max | V _{IN} = 7.0V |
| I _{CEX} | Output HIGH Leakage Current | | | 50 | μA | Max | V _{OUT} = V _{CC} |
| V _{ID} | Input Leakage Test | 4.75 | | | V | 0.0 | I _{ID} = 1.9 μA All Other Pins Grounded |
| I _{OD} | Output Leakage Circuit Current | | | 3.75 | μA | 0.0 | V _{ID} = 150 mV All Other Pins Grounded |
| I _{IL} | Input LOW Current | | | -0.6 | mA | Max | V _{IN} = 0.5V |
| I _{OZH} | Output Leakage Current | | | 50 | μA | Max | V _{OUT} = 2.7V |
| I _{OZL} | Output Leakage Current | | | -50 | μA | Max | V _{OUT} = 0.5V |
| I _{OS} | Output Short-Circuit Current | -60 | | -150 | mA | Max | V _{OUT} = 0V |
| I _{ZZ} | Bus Drainage Test | | | 500 | μA | 0.0V | V _{OUT} = 5.25V |
| I _{CCL} | Power Supply Current | | 35 | 55 | mA | Max | V _O = LOW |
| I _{CCZ} | Power Supply Current | | 35 | 55 | mA | Max | V _O = HIGH Z |

AC Electrical Characteristics

| Symbol | Parameter | T _A = +25°C V _{CC} = +5.0V C _L = 50 pF | | | T _A = -55°C to +125°C V _{CC} = +5.0V C _L = 50 pF | | T _A = 0°C to +70°C V _{CC} = +5.0V C _L = 50 pF | | Units |
|------------------|----------------------------------|---|-----|------|---|------|--|------|-------|
| | | Min | Typ | Max | Min | Max | Min | Max | |
| t _{PLH} | Propagation Delay | 3.0 | 5.3 | 7.0 | 3.0 | 9.0 | 3.0 | 8.0 | ns |
| t _{PHL} | D _n to O _n | 2.0 | 3.7 | 6.0 | 2.0 | 7.0 | 2.0 | 6.5 | |
| t _{PLH} | Propagation Delay | 5.0 | 9.0 | 11.0 | 5.0 | 13.5 | 5.0 | 12.0 | ns |
| t _{PHL} | LE to O _n | 3.0 | 5.2 | 7.0 | 3.0 | 7.5 | 3.0 | 7.0 | |
| t _{PZH} | Output Enable Time | 2.0 | 5.0 | 8.0 | 2.0 | 10.0 | 2.0 | 9.0 | ns |
| t _{PZL} | | 2.0 | 5.6 | 8.5 | 2.0 | 10.0 | 2.0 | 9.5 | |
| t _{PHZ} | Output Disable Time | 1.5 | 4.5 | 5.5 | 1.5 | 7.0 | 1.5 | 6.5 | ns |
| t _{PLZ} | | 1.5 | 3.8 | 5.5 | 1.5 | 5.5 | 1.5 | 5.5 | |

AC Operating Requirements

| Symbol | Parameter | T _A = +25°C V _{CC} = +5.0V | | T _A = -55°C to +125°C V _{CC} = +5.0V | | T _A = 0°C to +70°C V _{CC} = +5.0V | | Units |
|--------------------|-------------------------|---|-----|---|-----|--|-----|-------|
| | | Min | Max | Min | Max | Min | Max | |
| t _S (H) | Setup Time, HIGH or LOW | 2.0 | | 2.0 | | 2.0 | | ns |
| t _S (L) | D _n to LE | 2.0 | | 2.0 | | 2.0 | | |
| t _H (H) | Hold Time, HIGH or LOW | 3.0 | | 3.0 | | 3.0 | | ns |
| t _H (L) | D _n to LE | 3.5 | | 4.0 | | 3.5 | | |
| t _W (H) | LE Pulse Width, HIGH | 4.0 | | 4.0 | | 4.0 | | ns |

Physical Dimensions inches (millimeters) unless otherwise noted



**20-Lead Small Outline Integrated Circuit (SOIC), JEDEC MS-013, 0.300 Wide
Package Number M20B**

Physical Dimensions inches (millimeters) unless otherwise noted (Continued)

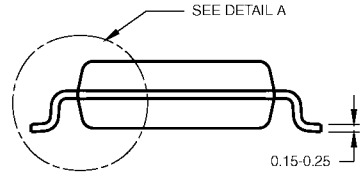
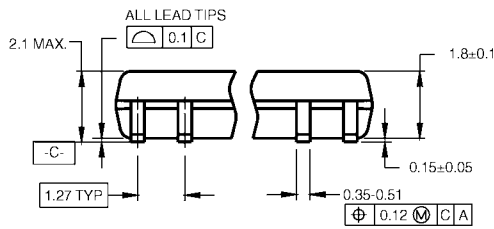
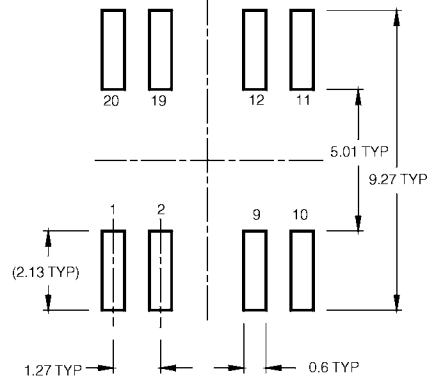
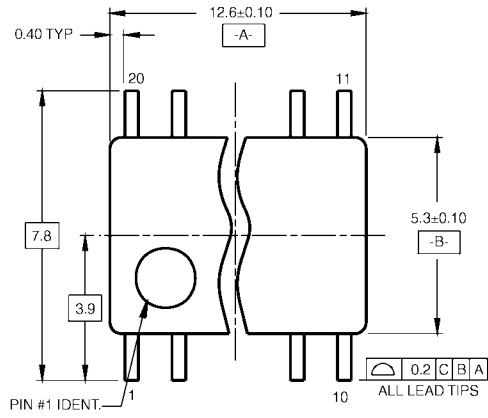

DIMENSIONS ARE IN MILLIMETERS

- NOTES:
 A. CONFORMS TO EIAJ EDR-7320 REGISTRATION, ESTABLISHED IN DECEMBER, 1998.
 B. DIMENSIONS ARE IN MILLIMETERS.
 C. DIMENSIONS ARE EXCLUSIVE OF BURRS, MOLD FLASH, AND TIE BAR EXTRUSIONS.

M20DRevB1

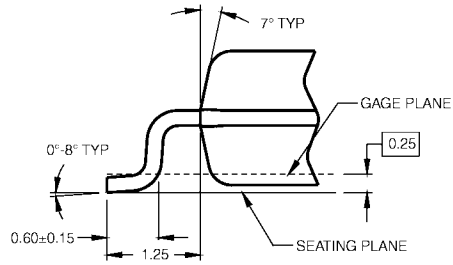

DETAIL A

**20-Lead Small Outline Package (SOP), EIAJ TYPE II, 5.3mm Wide
 Package Number M20D**

Physical Dimensions inches (millimeters) unless otherwise noted (Continued)

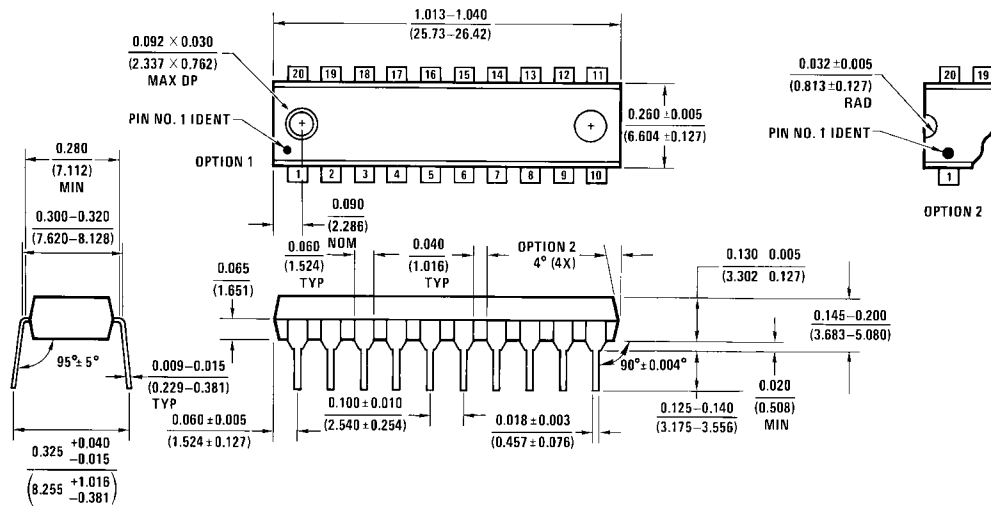

N20A (REV G)

**20-Lead Plastic Dual-In-Line Package (PDIP), JEDEC MS-001, 0.300 Wide
Package Number N20A**

Fairchild does not assume any responsibility for use of any circuitry described, no circuit patent licenses are implied and Fairchild reserves the right at any time without notice to change said circuitry and specifications.

LIFE SUPPORT POLICY

FAIRCHILD'S PRODUCTS ARE NOT AUTHORIZED FOR USE AS CRITICAL COMPONENTS IN LIFE SUPPORT DEVICES OR SYSTEMS WITHOUT THE EXPRESS WRITTEN APPROVAL OF THE PRESIDENT OF FAIRCHILD SEMICONDUCTOR CORPORATION. As used herein:

1. Life support devices or systems are devices or systems which, (a) are intended for surgical implant into the body, or (b) support or sustain life, and (c) whose failure to perform when properly used in accordance with instructions for use provided in the labeling, can be reasonably expected to result in a significant injury to the user.
2. A critical component in any component of a life support device or system whose failure to perform can be reasonably expected to cause the failure of the life support device or system, or to affect its safety or effectiveness.

www.fairchildsemi.com

Looking for pricing, stock, or lifecycle information?

Click below to explore more details on WIN SOURCE:

- ⊖ [View 74F573SC on WIN SOURCE](#)
- ⊖ [Fairchild/ON Semiconductor Information](#)

Optimize Your Supply Chain with WIN SOURCE Solutions

- ✓ Global Sourcing Solution
- ✓ Obsolete Management
- ✓ Cost Control Management
- ✓ Shortage Management
- ✓ Alternative Solution
- ✓ Excess Inventory Management