



**THE DATASHEET OF
74F181PC**



74F181

4-Bit Arithmetic Logic Unit

General Description

The 74F181 is a 4-bit Arithmetic logic Unit (ALU) which can perform all the possible 16 logic operations on two variables and a variety of arithmetic operations. It is 40% faster than the Schottky ALU and only consumes 30% as much power.

Features

- Full lookahead for high-speed arithmetic operation on long words

Ordering Code:

Order Number	Package Number	Package Description
74F181PC	N24A	24-Lead Plastic Dual-In-Line Package (PDIP), JEDEC MS-011, 0.600" Wide
74F181SPC	N24C	24-Lead Plastic Dual-In-Line Package (PDIP), JEDEC MS-001, 0.300" Wide

Logic Symbols

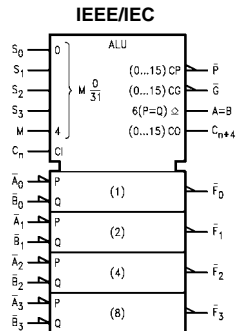
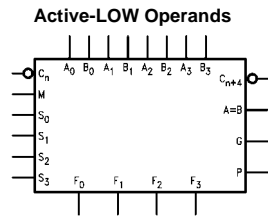
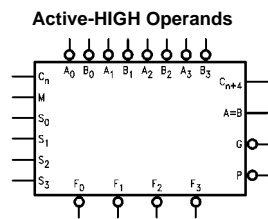

Connection Diagram

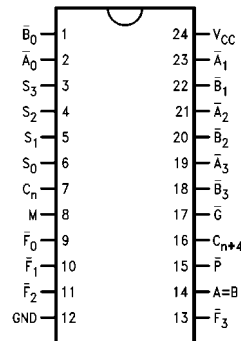

Unit Loading/Fan Out

Pin Names	Description	U.L. HIGH/LOW	Input I_{IH}/I_{IL} Output I_{OH}/I_{OL}
$\overline{A}_0-\overline{A}_3$	A Operand Inputs (Active LOW)	1.0/3.0	20 μ A/-1.8 mA
$\overline{B}_0-\overline{B}_3$	B Operand Inputs (Active LOW)	1.0/3.0	20 μ A/-1.8 mA
S_0-S_3	Function Select Inputs	1.0/4.0	20 μ A/-2.4 mA
M	Mode Control Input	1.0/1.0	20 μ A/-0.6 mA
C_n	Carry Input	1.0/5.0	20 μ A/-3.0 mA
$\overline{F}_0-\overline{F}_3$	Function Outputs (Active LOW)	50/33.3	-1 mA/20 mA
A = B	Comparator Output	OC (Note 1)/33.3	(Note 1)/20 mA
\overline{G}	Carry Generate Output (Active LOW)	50/33.3	-1 mA/20 mA
\overline{P}	Carry Propagate Output (Active LOW)	50/33.3	-1 mA/20 mA
C_{n+4}	Carry Output	50/33.3	-1 mA/20 mA

Note 1: OC-Open Collector

Functional Description

The 74F181 is a 4-bit high-speed parallel Arithmetic Logic Unit (ALU). Controlled by the four Function Select inputs (S_0-S_3) and the Mode Control input (M), it can perform all the 16 possible logic operations or 16 different arithmetic operations on Active HIGH or Active LOW operands. The Function Table lists these operations.

When the Mode Control input (M) is HIGH, all internal carries are inhibited and the device performs logic operations on the individual bits as listed. When the Mode Control input is LOW, the carries are enabled and the device performs arithmetic operations on the two 4-bit words. The device incorporates full internal carry lookahead and provides for either ripple carry between devices using the C_{n+4} output, or for carry lookahead between packages using the signals \overline{P} (Carry Propagate) and \overline{G} (Carry Generate). In the Add mode, \overline{P} indicates that \overline{F} is 15 or more, while \overline{G} indicates that \overline{F} is 16 or more. In the Subtract mode \overline{P} indicates that \overline{F} is zero or less, while \overline{G} indicates that \overline{F} is less than zero. \overline{P} and \overline{G} are not affected by carry in. When speed requirements are not stringent, the 74F181 can be used in a simple Ripple Carry mode by connecting the Carry output (C_{n+4}) signal to the Carry input (C_n) of the next unit. For high speed operation the device is used in conjunction with a carry lookahead circuit. One carry lookahead package is required for each group of four 74F181

devices. Carry lookahead can be provided at various levels and offers high speed capability over extremely long word lengths.

The A = B output from the device goes HIGH when all four \overline{F} outputs are HIGH and can be used to indicate logic equivalence over four bits when the unit is in the Subtract mode. The A = B output is open collector and can be wired AND with other A = B outputs to give a comparison for more than four bits. The A = B signal can also be used with the C_{n+4} signal to indicate $A > B$ and $A < B$.

The Function Table lists the arithmetic operations that are performed without a carry in. An incoming carry adds a one to each operation. Thus, select code LHHL generates A minus B minus 1 (2s complement notation) without a carry in and generates A minus B when a carry is applied. Because subtraction is actually performed by complementary addition (1s complement), a carry out means borrow; thus a carry is generated when there is no underflow and no carry is generated when there is underflow. As indicated, this device can be used with either active LOW inputs producing active LOW outputs or with active HIGH inputs producing active HIGH outputs. For either case the table lists the operations that are performed to the operands labeled inside the logic symbol.

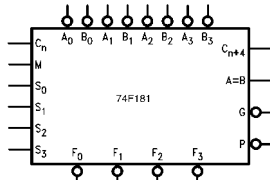
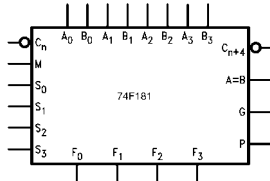
Operation Table							
	S ₀	S ₁	S ₂	S ₃	Logic (M=H)	Arithmetic (M=L, C ₀ =Inactive)	Arithmetic (M=L, C ₀ =Active)
 <p>a. All Input Data Inverted</p>	L	L	L	L	\bar{A}	A minus 1	A
	H	L	L	L	$\bar{A} \cdot \bar{B}$	A • B minus 1	A • B
	L	H	L	L	$\bar{A} + B$	A • \bar{B} minus 1	A • \bar{B}
	H	H	L	L	Logic "1"	minus 1 (2s comp.)	Zero
	L	L	H	L	$\bar{A} + \bar{B}$	A plus (A + \bar{B})	A plus (A + \bar{B}) plus 1
	H	L	H	L	\bar{B}	A • B plus (A + \bar{B})	A • B plus (A + \bar{B}) plus 1
	L	H	H	L	$\bar{A} \oplus \bar{B}$	A minus B minus 1	A minus B
	H	H	H	L	A + \bar{B}	A + \bar{B}	A + \bar{B} plus 1
	L	L	L	H	$\bar{A} \cdot B$	A plus (A + B)	A plus (A + B) plus 1
	H	L	L	H	A ⊕ B	A plus B	A plus B plus 1
	L	H	L	H	B	A • \bar{B} plus (A + B)	A • \bar{B} plus (A + B) plus 1
	H	H	L	H	A + B	A + B	A + B plus 1
	L	L	H	H	Logic "0"	A plus A (2 × A)	A plus A (2 × A) plus 1
	H	L	H	H	A • \bar{B}	A plus A • B	A plus A • B plus 1
	L	H	H	H	A • B	A plus A • \bar{B}	A plus A • \bar{B} plus 1
	H	H	H	H	A	A	A plus 1
 <p>b. All Input Data True</p>	L	L	L	L	\bar{A}	A	A plus 1
	H	L	L	L	$\bar{A} + \bar{B}$	A + B	A + B plus 1
	L	H	L	L	$\bar{A} \cdot B$	A + \bar{B}	A + \bar{B} plus 1
	H	H	L	L	Logic "0"	minus 1 (2s comp.)	Zero
	L	L	H	L	$\bar{A} \cdot \bar{B}$	A plus (A • \bar{B})	A plus A • \bar{B} plus 1
	H	L	H	L	\bar{B}	A • \bar{B} plus (A + B)	A • B plus (A + B) plus 1
	L	H	H	L	A ⊕ B	A minus B minus 1	A minus B
	H	H	H	L	A • \bar{B}	A • \bar{B} minus 1	A • \bar{B}
	L	L	L	H	$\bar{A} + B$	A plus A • B	A plus A • B plus 1
	H	L	L	H	$\bar{A} \oplus \bar{B}$	A plus B	A plus B plus 1
	L	H	L	H	B	A • B plus (A + \bar{B})	A • B plus (A + \bar{B}) plus 1
	H	H	L	H	A • B	A • B minus 1	A • B
	L	L	H	H	Logic "1"	A plus A (2 × A)	A plus A (2 × A) plus 1
	H	L	H	H	A + \bar{B}	A plus (A + B)	A plus (A + B) plus 1
	L	H	H	H	A + B	A plus (A + \bar{B})	A plus (A + \bar{B}) plus 1
	H	H	H	H	A	A	A minus 1

Operation Table (Continued)

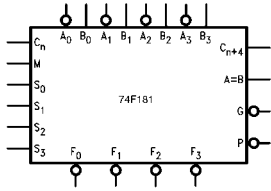
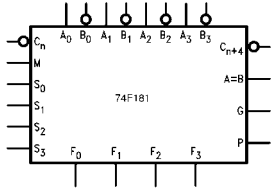
	S ₀	S ₁	S ₂	S ₃	Logic (M=H)	Arithmetic (M=L, C ₀ =Inactive)	Arithmetic (M=L, C ₀ =Active)
 <p>c. A All Input Data Inverted; B Input Data True</p>	L	L	L	L	\bar{A}	A minus 1	A
	H	L	L	L	$\bar{A} + B$	A • \bar{B} minus 1	A • B
	L	H	L	L	$\bar{A} \cdot \bar{B}$	A • B minus 1	A • B
	H	H	L	L	Logic "1"	minus 1 (2s comp.)	Zero
	L	L	H	L	$\bar{A} \cdot B$	A plus (A + B)	A plus (A + B) plus 1
	H	L	H	L	B	A • \bar{B} plus (A + B)	A • \bar{B} plus (A + B) plus 1
	L	H	H	L	A ⊕ B	A plus B	A plus B plus 1
	H	H	H	L	A + B	A + B	A + B plus 1
	L	L	L	H	$\bar{A} + \bar{B}$	A plus (A + \bar{B})	A plus (A + \bar{B}) plus 1
	H	L	L	H	$\bar{A} \oplus \bar{B}$	A minus B minus 1	A minus B
	L	H	L	H	\bar{B}	A • B plus (A + \bar{B})	A • B plus (A + \bar{B}) plus 1
	H	H	L	H	A + \bar{B}	A + \bar{B}	A + \bar{B} plus 1
	L	L	H	H	Logic "0"	A plus A (2 × A)	A plus A (2 × A) plus 1
	H	L	H	H	A • B	A plus A • \bar{B}	A plus A • \bar{B} plus 1
	L	H	H	H	A • \bar{B}	A plus A • B	A plus A • B plus 1
	H	H	H	H	A	A	A plus 1
 <p>d. A Input Data True; B Input Data Inverted</p>	L	L	L	L	\bar{A}	A	A plus 1
	H	L	L	L	$\bar{A} \cdot B$	A + \bar{B}	A + \bar{B} plus 1
	L	H	L	L	$\bar{A} + \bar{B}$	A + B	A + B plus 1
	H	H	L	L	Logic "0"	minus 1 (2s comp.)	Zero
	L	L	H	L	$\bar{A} + B$	A plus A • B	A plus A • B plus 1
	H	L	H	L	B	A • B plus (A + \bar{B})	A • \bar{B} plus (A + B) plus 1
	L	H	H	L	$\bar{A} \oplus \bar{B}$	A plus B	A plus B plus 1
	H	H	H	L	A • B	A • B minus 1	A • B
	L	L	L	H	$\bar{A} \cdot \bar{B}$	A plus A • \bar{B}	A plus A • B plus 1
	H	L	L	H	A ⊕ B	A minus B minus 1	A minus B
	L	H	L	H	\bar{B}	A • \bar{B} plus (A + B)	A • \bar{B} plus (A + B) plus 1
	H	H	L	H	A • \bar{B}	A • \bar{B} minus 1	A • \bar{B}
	L	L	H	H	Logic "1"	A plus A (2 × A)	A plus A (2 × A) plus 1
	H	L	H	H	A + B	A plus (A + \bar{B})	A plus (A + \bar{B}) plus 1
	L	H	H	H	A + \bar{B}	A plus (A + B)	A plus (A + B) plus 1
	H	H	H	H	A	A minus 1	A

Logic Diagram

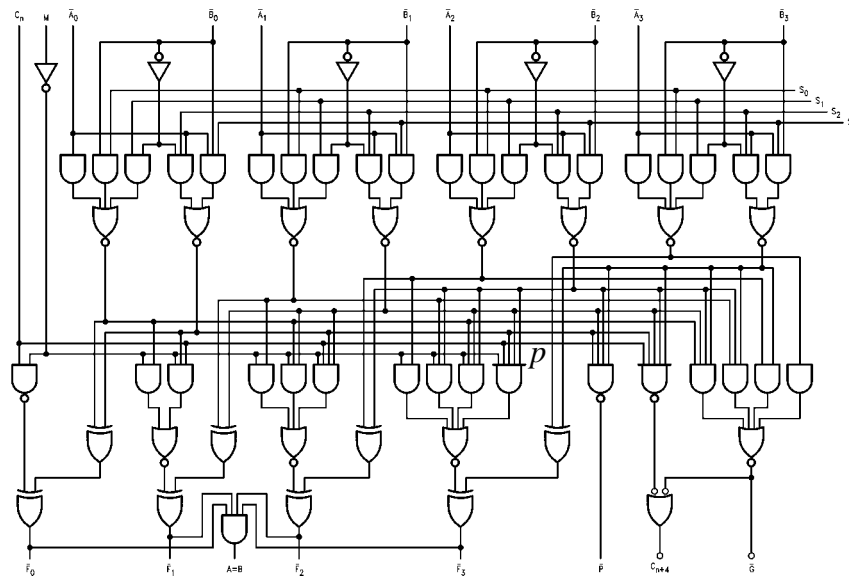

Please note that this diagram is provided only for the understanding of logic operations and should not be used to estimate propagation delays.

Absolute Maximum Ratings (Note 2)

Storage Temperature	-65°C to +150°C
Ambient Temperature under Bias	-55°C to +125°C
Junction Temperature under Bias	-55°C to +150°C
V _{CC} Pin Potential to Ground Pin	-0.5V to +7.0V
Input Voltage (Note 3)	-0.5V to +7.0V
Input Current (Note 3)	-30 mA to +5.0 mA
Voltage Applied to Output in HIGH State (with V _{CC} = 0V)	
Standard Output	-0.5V to V _{CC}
3-STATE Output	-0.5V to +5.5V
Current Applied to Output in LOW State (Max)	twice the rated I _{OL} (mA)
ESD Last Passing Voltage (Min)	4000V

Recommended Operating Conditions

Free Air Ambient Temperature	0°C to +70°C
Supply Voltage	+4.5V to +5.5V

Note 2: Absolute maximum ratings are values beyond which the device may be damaged or have its useful life impaired. Functional operation under these conditions is not implied.

Note 3: Either voltage limit or current limit is sufficient to protect inputs.

DC Electrical Characteristics

Symbol	Parameter	Min	Typ	Max	Units	V _{CC}	Conditions
V _{IH}	Input HIGH Voltage	2.0			V		Recognized as a HIGH Signal
V _{IL}	Input LOW Voltage			0.8	V		Recognized as a LOW Signal
V _{CD}	Input Clamp Diode Voltage			-1.2	V	Min	I _{IN} = -18 mA
V _{OH}	Output HIGH Voltage	10% V _{CC} 5% V _{CC}	2.5 2.7		V	Min	I _{OH} = -1 mA I _{OH} = -1 mA
V _{OL}	Output LOW Voltage	10% V _{CC}		0.5	V	Min	I _{OL} = 20 mA
I _{IH}	Input HIGH Current			5.0	μA	Max	V _{IN} = 2.7V
I _{BVI}	Input HIGH Current Breakdown Test			7.0	μA	Max	V _{IN} = 7.0V
I _{CEX}	Output HIGH Leakage Current			50	μA	Max	V _{OUT} = V _{CC} ($\bar{F}_n, \bar{G}, \bar{P}, C_{n+4}$)
V _{ID}	Input Leakage Test	4.75			V	0.0	I _{ID} = 1.9 μA All Other Pins Grounded
I _{OD}	Output Leakage Circuit Current			3.75	μA	0.0	V _{IOD} = 150 mV All Other Pins Grounded
I _{IL}	Input LOW Current			-0.6 -1.8 -2.4 -3.0	mA	Max	V _{IN} = 0.5V (M) V _{IN} = 0.5V ($\bar{A}_0, \bar{A}_1, \bar{A}_3, \bar{B}_0, \bar{B}_1, \bar{B}_3$) V _{IN} = 0.5V (S _n , \bar{A}_2, \bar{B}_2) V _{IN} = 0.5V (C _n)
I _{OS}	Output Short-Circuit Current	-60		-150	mA	Max	V _{OUT} = 0V ($\bar{F}_n, \bar{G}, \bar{P}, C_{n+4}$)
I _{OHC}	Open Collector, Output OFF Leakage Test			250	μA	Min	V _O = V _{CC} (A = B)
I _{CCH}	Power Supply Current		43	65.0	mA	Max	V _O = HIGH
I _{CCL}	Power Supply Current		43	65.0	mA	Max	V _O = LOW

AC Electrical Characteristics										
Symbol	Parameter		$T_A = +25^\circ\text{C}$			$T_A = -55^\circ\text{C to } +125^\circ\text{C}$		$T_A = 0^\circ\text{C to } +70^\circ\text{C}$		Units
			$V_{CC} = +5.0\text{V}$			$V_{CC} = +5.0\text{V}$		$V_{CC} = +5.0\text{V}$		
	Path	Mode	$C_L = 50\text{ pF}$			$C_L = 50\text{ pF}$		$C_L = 50\text{ pF}$		
			Min	Typ	Max	Min	Max	Min	Max	
t_{PLH}	Propagation Delay		3.0	6.4	8.5	3.0	10.0	3.0	9.5	ns
t_{PHL}	C_n to C_{n+4}		3.0	6.1	8.0	3.0	9.5	3.0	9.0	
t_{PLH}	Propagation Delay		5.0	10.0	13.0	5.0	15.5	5.0	14.0	ns
t_{PHL}	\bar{A} or \bar{B} to C_{n+4}	Sum	4.0	9.4	12.0	3.5	16.5	4.0	13.0	
t_{PLH}	Propagation Delay		5.0	10.8	14.0	5.0	17.0	5.0	15.0	ns
t_{PHL}	\bar{A} or \bar{B} to C_{n+4}	Dif	5.0	10.0	13.0	4.0	15.0	5.0	14.0	
t_{PLH}	Propagation Delay		3.0	6.7	8.5	2.5	16.0	3.0	9.5	ns
t_{PHL}	C_n to \bar{F}	Any	3.0	6.5	8.5	2.5	12.0	3.0	9.5	
t_{PLH}	Propagation Delay		3.0	5.7	7.5	2.5	9.0	3.0	8.5	ns
t_{PHL}	\bar{A} or \bar{B} or \bar{G}	Sum	3.0	5.8	7.5	2.5	9.5	3.0	8.5	
t_{PLH}	Propagation Delay		3.0	6.5	8.5	2.5	11.5	3.0	9.5	ns
t_{PHL}	\bar{A} or \bar{B} to \bar{G}	Dif	3.0	7.3	9.5	2.5	11.0	3.0	10.5	
t_{PLH}	Propagation Delay		3.0	5.0	7.0	2.5	8.5	3.0	8.0	ns
t_{PHL}	\bar{A} or \bar{B} to \bar{P}	Sum	3.0	5.5	7.5	3.0	9.5	3.0	8.5	
t_{PLH}	Propagation Delay		3.0	5.8	7.5	2.5	11.0	3.0	8.5	ns
t_{PHL}	\bar{A} or \bar{B} to \bar{P}	Dif	4.0	6.5	8.5	3.0	11.0	4.0	9.5	
t_{PLH}	Propagation Delay		3.0	7.0	9.0	3.0	14.5	3.0	10.0	ns
t_{PHL}	\bar{A}_i or \bar{B}_i to \bar{F}_i	Sum	3.0	7.2	10.0	3.0	14.5	3.0	10.0	
t_{PLH}	Propagation Delay		3.0	8.2	11.0	3.0	17.5	3.0	12.0	ns
t_{PHL}	\bar{A}_i or \bar{B}_i to \bar{F}_i	Dif	3.0	5.0	11.0	3.0	14.5	3.0	12.0	
t_{PLH}	Propagation Delay		4.0	8.0	10.5	3.5	16.5	4.0	11.5	ns
t_{PHL}	Any \bar{A} or \bar{B} to Any \bar{F}	Sum	4.0	7.8	10.0	4.0	13.5	4.0	11.0	
t_{PLH}	Propagation Delay		4.5	9.4	12.0	3.5	17.5	4.5	13.0	ns
t_{PHL}	Any \bar{A} or \bar{B} to Any \bar{F}	Dif	3.5	9.4	12.0	3.0	14.0	3.5	13.0	
t_{PLH}	Propagation Delay		4.0	6.0	9.0	3.5	14.5	4.0	10.0	ns
t_{PHL}	\bar{A} or \bar{B} to \bar{F}	Logic	4.0	6.0	10.0	3.0	15.5	4.0	11.0	
t_{PLH}	Propagation Delay		11.0	18.5	27.0	8.0	35.0	11.0	29.0	ns
t_{PHL}	\bar{A} or \bar{B} to $A = B$	Dif	6.0	9.8	12.5	5.5	21.0	6.0	13.5	

Physical Dimensions inches (millimeters) unless otherwise noted

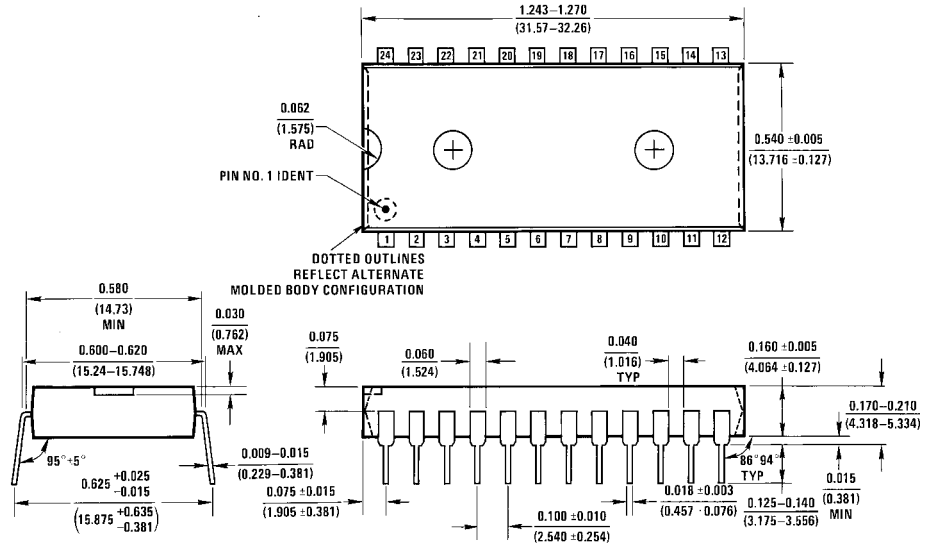

N24A (REV E)

**24-Lead Plastic Dual-In-Line Package (PDIP), JEDEC MS-011, 0.600" Wide
Package Number N24A**

Physical Dimensions inches (millimeters) unless otherwise noted (Continued)

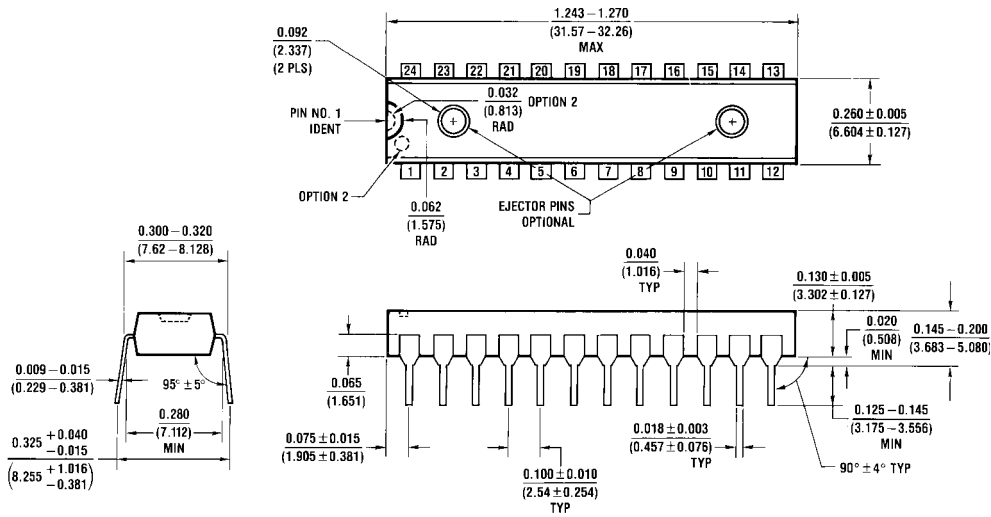

**24-Lead Plastic Dual-In-Line Package (PDIP), JEDEC MS-001, 0.300" Wide
Package Number N24C**

N24C (REV F)

Fairchild does not assume any responsibility for use of any circuitry described, no circuit patent licenses are implied and Fairchild reserves the right at any time without notice to change said circuitry and specifications.

LIFE SUPPORT POLICY



FAIRCHILD'S PRODUCTS ARE NOT AUTHORIZED FOR USE AS CRITICAL COMPONENTS IN LIFE SUPPORT DEVICES OR SYSTEMS WITHOUT THE EXPRESS WRITTEN APPROVAL OF THE PRESIDENT OF FAIRCHILD SEMICONDUCTOR CORPORATION. As used herein:

1. Life support devices or systems are devices or systems which, (a) are intended for surgical implant into the body, or (b) support or sustain life, and (c) whose failure to perform when properly used in accordance with instructions for use provided in the labeling, can be reasonably expected to result in a significant injury to the user.
2. A critical component in any component of a life support device or system whose failure to perform can be reasonably expected to cause the failure of the life support device or system, or to affect its safety or effectiveness.

www.fairchildsemi.com

Looking for pricing, stock, or lifecycle information?

Click below to explore more details on WIN SOURCE:

-  [View 74F181PC on WIN SOURCE](#)
-  [Fairchild/ON Semiconductor](#) Information

Optimize Your Supply Chain with WIN SOURCE Solutions

-  Global Sourcing Solution
-  Obsolete Management
-  Cost Control Management
-  Shortage Management
-  Alternative Solution
-  Excess Inventory Management