

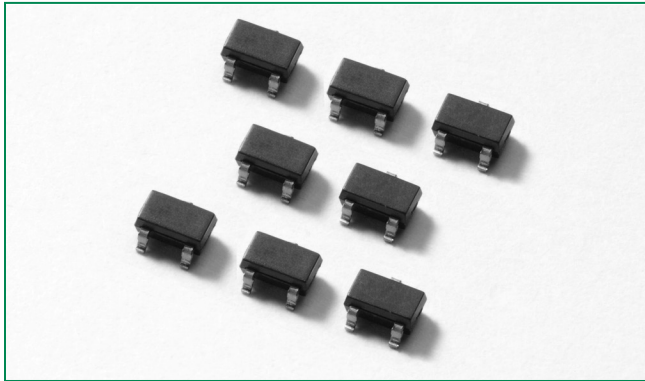

THE DATASHEET OF SLVU2.8HTG



SLVU2.8 Series 2.8V 40A TVS Array



Pinout

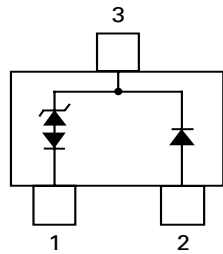

Functional Block Diagram

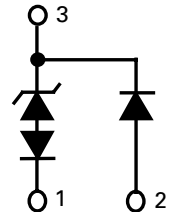

Additional Information



Description

The SLVU2.8 series was designed to protect low voltage, CMOS devices from ESD and lightning induced transients. There is a compensating diode in parallel with the low voltage TVS to protect one unidirectional line or a high speed data pair when two devices are paired together. These robust structures can safely absorb repetitive ESD strikes at $\pm 30\text{kV}$ (contact discharge) per the IEC 61000-4-2 standard and each structure can safely dissipate up to 40A (IEC 61000-4-5, $t_p=8/20\mu\text{s}$) with very low clamping voltages.

Features

- ESD, IEC 61000-4-2, $\pm 30\text{kV}$ contact, $\pm 30\text{kV}$ air
- EFT, IEC 61000-4-4, 40A (5/50ns)
- Lightning, IEC 61000-4-5, 2nd edition 40A (8/20 μs)
- Low capacitance of 2pF per line (Pin 2 to 1)
- Low leakage current of 1 μA (MAX) at 2.8V
- Small SOT23-3 (JEDEC TO-236) package saves board space
- RoHS compliant and lead-free

Applications

- 10/100/1000 Ethernet
- WAN/LAN Equipment
- Switching Systems
- Desktops, Servers, and Notebooks
- Analog Inputs
- Base Stations
- Security Systems
- Surveillance Cameras

Application Example

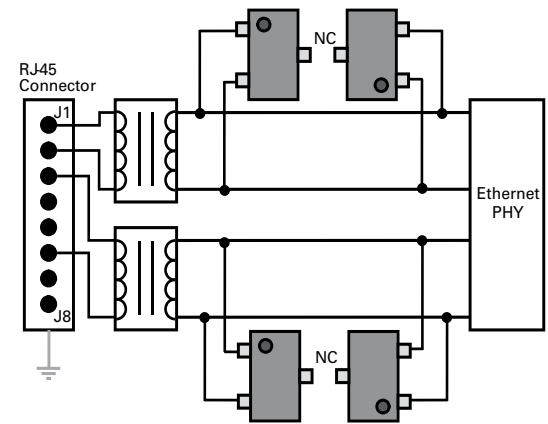

Electrical Characteristics (T_{OP} = 25°C)

Parameter	Symbol	Test Conditions	Min	Typ	Max	Units
Reverse Standoff Voltage	V _{RWM}	I _R ≤ 1 μA			2.8	V
Reverse Breakdown Voltage	V _{BR}	I _T = 2 μA	3.0			V
Snap Back Voltage	V _{SB}	I _T = 50 mA	2.8			V
Reverse Leakage Current	I _{LEAK}	V _R = 2.8 V (Pin 2 or 3 to 1)			1	μA
Clamping Voltage ¹	V _C	I _{PP} = 5 A, t _p = 8/20 μs (Pin 3 to 1)		5.7	7.0	V
Clamping Voltage ¹		I _{PP} = 24 A, t _p = 8/20 μs (Pin 3 to 1)		8.3	12.5	V
Clamping Voltage ¹		I _{PP} = 5 A, t _p = 8/20 μs (Pin 2 to 1)		7.0	8.5	V
Clamping Voltage ¹		I _{PP} = 24 A, t _p = 8/20 μs (Pin 2 to 1)		13.9	15.0	V
Dynamic Resistance	R _{DYN}	(V _{C2} - V _{C1}) / (I _{PP2} - I _{PP1}) (Pin 2 to 1)		0.4		Ω
ESD Withstand Voltage ¹	V _{ESD}	IEC61000-4-2 (Contact)	±30			kV
		IEC61000-4-2 (Air)	±30			kV
Diode Capacitance ¹	C _D	V _R = 0 V, f = 1 MHz (Pin 2 to 1)		2.0	2.5	pF

Note: ¹Parameter is guaranteed by design and/or device characterization.

Absolute Maximum Ratings

Parameter	Rating	Units
Peak Pulse Power (t _p = 8/20 μs)	600	W
Peak Pulse Current (t _p = 8/20 μs)	40	A
Operating Temperature	-40 to 125	°C
Storage Temperature	-55 to 150	°C

CAUTION: Stresses above those listed in "Absolute Maximum Ratings" may cause permanent damage to the device. This is a stress only rating and operation of the device at these or any other conditions above those indicated in the operational sections of this specification is not implied.

Figure 1: Capacitance vs. Reverse Voltage

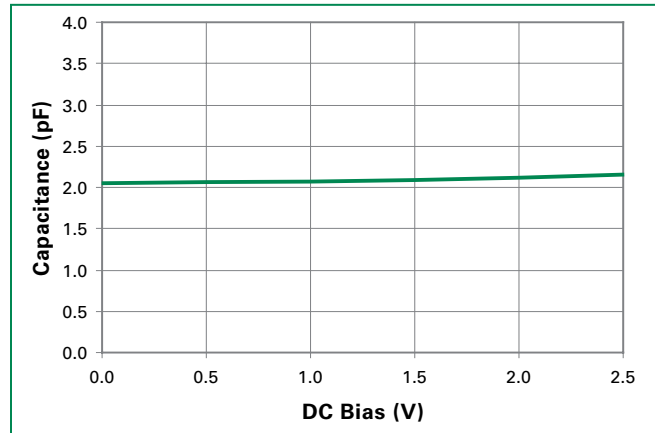

Figure 2: Clamping Voltage vs. I_{PP}

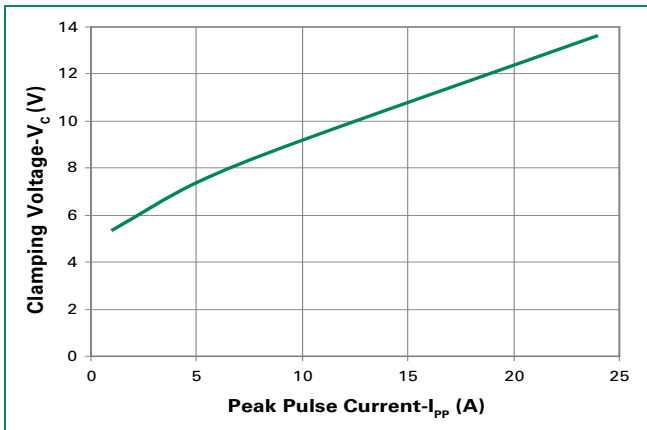
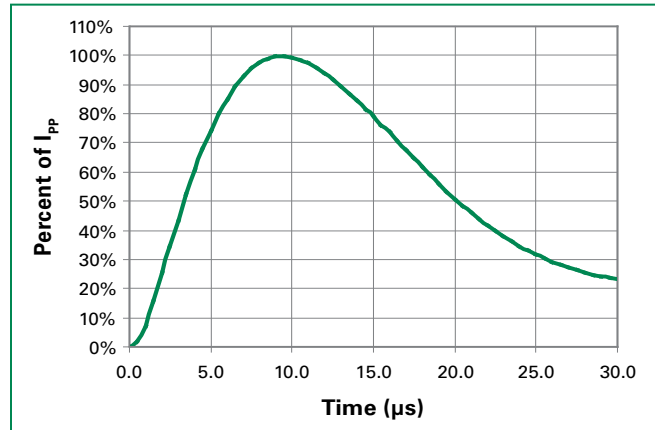
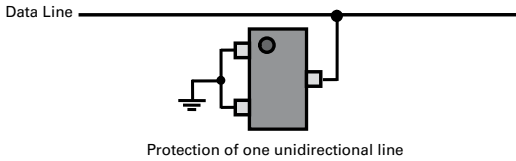

Figure 3: Pulse Waveform



Application Example Detail



Protection of one unidirectional line

Protection of one unidirectional data line is realized by connecting pin 3 to the protected line, and pins 1 and 2 to GND. In this configuration, the device presents a maximum loading capacitance of tens of picofarads. During positive transients, the internal TVS diode will conduct and steer current from pin 3 to 1 (GND), clamping the data line at or below the specified voltages for the device (see Electrical Characteristics section). For negative transients, the internal compensating diode is forward biased, steering the current from pin 2 (GND) to 3.

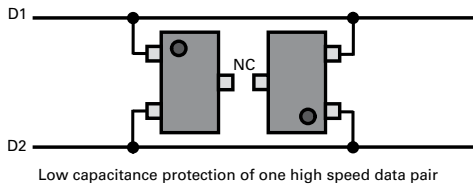

Low capacitance protection of one high speed data pair

Low capacitance protection of a high-speed data pair is realized by connecting two devices in antiparallel. As shown, pin 1 of the first device is connected to D1 and pin 2 is connected to D2. Additionally, pin 2 of the second device is connected to D1 and pin 1 is connected to D2. Pin 3 must be NC (or not connected) for both devices. When the potential on D1 exceeds the potential on D2 (by the rated standoff voltage), pin 2 on the second device will steer current into pin 1. The compensating diode will conduct in the forward direction steering current into the avalanching TVS diode which is operating in the reverse direction. For the opposite transient, the first device will behave in the same manner. In this two device arrangement, the total loading capacitance is two times the rated capacitance from pin 2 to pin 1 which will typically be much less than 10pF making it suitable for high-speed data pair such as 10/100/1000 Ethernet.

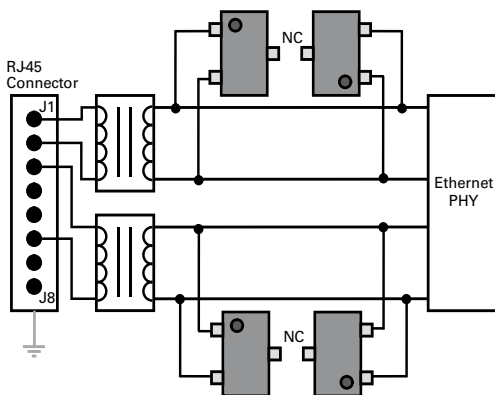

Product Characteristics

Lead Plating	Matte Tin
Lead Material	Copper Alloy
Lead Coplanarity	0.0004 inches (0.102mm)
Substitute Material	Silicon
Body Material	Molded Epoxy
Flammability	UL 94 V-0

Notes :

1. All dimensions are in millimeters
2. Dimensions include solder plating.
3. Dimensions are exclusive of mold flash & metal burr.
4. Blo is facing up for mold and facing down for trim/form, i.e. reverse trim/form.
5. Package surface matte finish VDI 11-13.

Soldering Parameters

Reflow Condition		Pb – Free assembly
Pre Heat	- Temperature Min ($T_{s(min)}$)	150°C
	- Temperature Max ($T_{s(max)}$)	200°C
	- Time (min to max) (t_s)	60 – 180 secs
Average ramp up rate (Liquidus Temp (T_L) to peak)		3°C/second max
$T_{s(max)}$ to T_L - Ramp-up Rate		3°C/second max
Reflow	- Temperature (T_L) (Liquidus)	217°C
	- Temperature (t_L)	60 – 150 seconds
Peak Temperature (T_p)		260 ^{+0/-5} °C
Time within 5°C of actual peak Temperature (t_p)		20 – 40 seconds
Ramp-down Rate		6°C/second max
Time 25°C to peak Temperature (T_p)		8 minutes Max.
Do not exceed		260°C

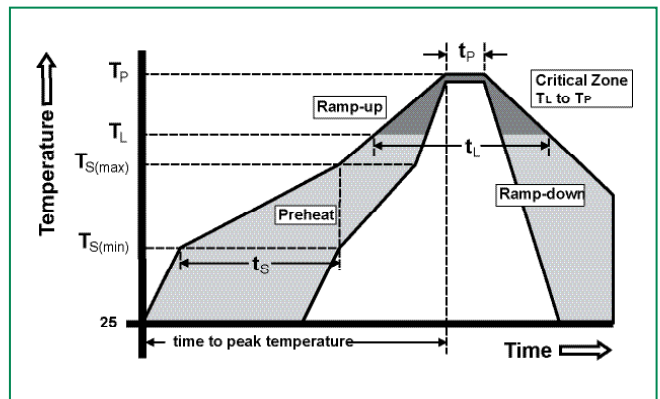

Package Dimensions – SOT-23

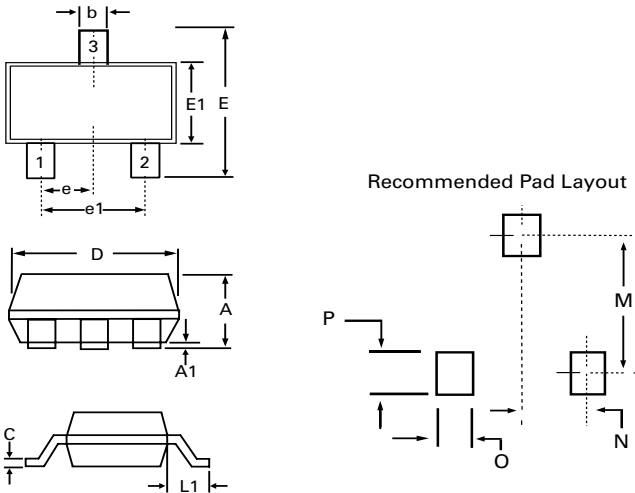

Package	SOT23-3			
Pins	3			
JEDEC	TO-236			
	Millimetres		Inches	
	Min	Max	Min	Max
A	0.89	1.12	0.035	0.044
A1	0.01	0.1	0.0004	0.004
b	0.3	0.5	0.012	0.020
c	0.08	0.2	0.003	0.008
D	2.8	3.04	0.110	0.120
E	2.1	2.64	0.083	0.104
E1	1.2	1.4	0.047	0.055
e	0.95 BSC		0.038 BSC	
e1	1.90 BSC		0.075 BSC	
L1	0.54 REF		0.021 REF	
M		2.29		.90
N		0.95		0.038
O		0.78		0.30 TYP
P		0.78		0.30 TYP

Part Numbering System

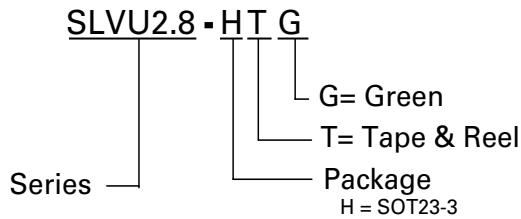

Part Marking System

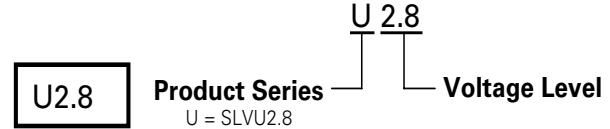

Ordering Information

Part Number	Package	Marking	Min. Order Qty.
SLVU2.8HTG	SOT23-3	U2.8	3000

Embossed Carrier Tape & Reel Specification – SOT23-3 Package

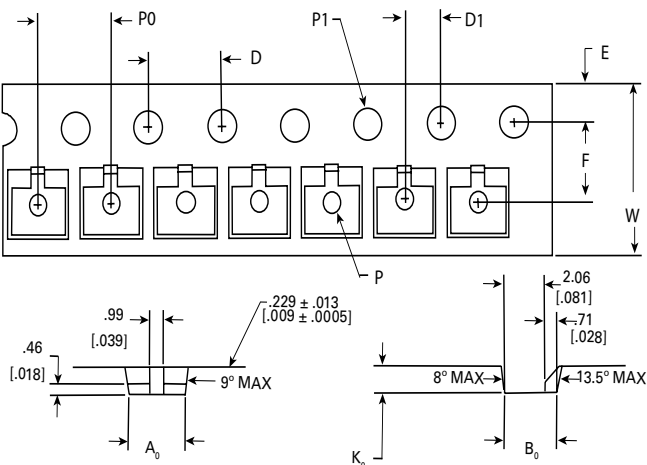

Symbol	Millimetres		Inches	
	Min	Max	Min	Max
A0	3.05	3.25	0.12	0.128
B0	2.67	2.87	0.105	0.113
D	3.9	4.1	0.153	0.161
D1	1.95	2.05	0.788	0.792
E	1.65	1.85	0.065	0.073
F	3.45	3.55	0.136	0.14
K0	1.12	1.32	0.476	0.484
P	0.95	1.05	0.037	0.041
P0	3.9	4.1	0.153	0.161
P1		1.6		0.063
W	7.9	8.3	0.311	0.327

Looking for pricing, stock, or lifecycle information?

Click below to explore more details on WIN SOURCE:

 [View SLVU2.8HTG on WIN SOURCE](#)

 [Littelfuse Inc. Information](#)

Optimize Your Supply Chain with WIN SOURCE Solutions

-  Global Sourcing Solution
-  Obsolete Management
-  Cost Control Management
-  Shortage Management
-  Alternative Solution
-  Excess Inventory Management