

74F169 4-Stage Synchronous Bidirectional Counter

General Description

The 74F169 is a fully synchronous 4-stage up/down counter. The 74F169 is a modulo-16 binary counter. Features a preset capability for programmable operation, carry lookahead for easy cascading and a U/D input to control the direction of counting. All state changes, whether in counting or parallel loading, are initiated by the LOW-to-HIGH transition of the clock.

Features

- Asynchronous counting and loading
- Built-in lookahead carry capability
- Presettable for programmable operation

Ordering Code:

Order Number	Package Number	Package Description
74F169SC	M16A	16-Lead Small Outline Integrated Circuit (SOIC), JEDEC MS-012, 0.150 Narrow
74F169SJ	M16D	16-Lead Small Outline Package (SOP), EIAJ TYPE II, 5.3mm Wide
74F169PC	N16E	16-Lead Plastic Dual-In-Line Package (PDIP), JEDEC MS-001, 0.300 Wide

Devices also available in Tape and Reel. Specify by appending the suffix letter "X" to the ordering code.

Logic Symbols

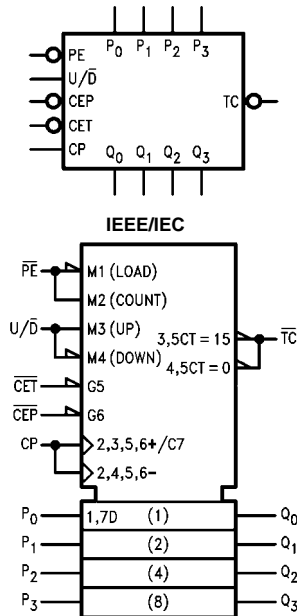

Connection Diagram

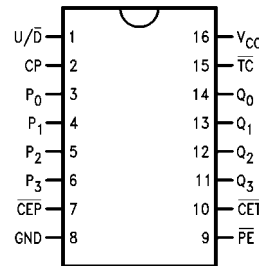

Unit Loading/Fan Out

Pin Names	Description	U.L. HIGH/LOW	Input I_{IH}/I_{IL} Output I_{OH}/I_{OL}
\overline{CEP}	Count Enable Parallel Input (Active LOW)	1.0/1.0	20 μ A/-0.6 mA
\overline{CET}	Count Enable Trickle Input (Active LOW)	1.0/2.0	20 μ A/-1.2 mA
CP	Clock Pulse Input (Active Rising Edge)	1.0/1.0	20 μ A/-0.6 mA
P_0 - P_3	Parallel Data Inputs	1.0/1.0	20 μ A/-0.6 mA
\overline{PE}	Parallel Enable Input (Active LOW)	1.0/1.0	20 μ A/-0.6 mA
U/ \overline{D}	Up-Down Count Control Input	1.0/1.0	20 μ A/-0.6 mA
Q_0 - Q_3	Flip-Flop Outputs	50/33.3	-1 mA/20 mA
\overline{TC}	Terminal Count Output (Active LOW)	50/33.3	-1 mA/20 mA

Functional Description

The 74F169 uses edge-triggered J-K type flip-flops and has no constraints on changing the control or data input signals in either state of the clock. The only requirement is that the various inputs attain the desired state at least a setup time before the rising edge of the clock and remain valid for the recommended hold time thereafter. The parallel load operation takes precedence over other operations, as indicated in the Mode Select Table. When \overline{PE} is LOW, the data on the P_0 - P_3 inputs enters the flip-flops on the next rising edge of the clock. In order for counting to occur, both \overline{CEP} and \overline{CET} must be LOW and \overline{PE} must be HIGH; the U/ \overline{D} input then determines the direction of counting. The Terminal Count (\overline{TC}) output is normally HIGH and goes LOW, provided that \overline{CET} is LOW, when a counter reaches zero in the Count Down mode or reaches 15 for the 74F169 in the Count Up mode. The \overline{TC} output state is not a function of the Count Enable Parallel (\overline{CEP}) input level. Since the \overline{TC} signal is derived by decoding the flip-flop states, there exists the possibility of decoding spikes on \overline{TC} . For this reason the use of \overline{TC} as a clock signal is not recommended (see logic equations below).

- Count Enable = $\overline{CEP} \cdot \overline{CET} \cdot \overline{PE}$
- Up: (74F169): $\overline{TC} = Q_0 \cdot Q_1 \cdot Q_2 \cdot Q_3 \cdot (\text{Up}) \cdot \overline{CET}$
- Down: $\overline{TC} = \overline{Q_0} \cdot \overline{Q_1} \cdot \overline{Q_2} \cdot \overline{Q_3} \cdot (\text{Down}) \cdot \overline{CET}$

Mode Select Table

\overline{PE}	\overline{CEP}	\overline{CET}	U/ \overline{D}	Action on Rising Clock Edge
L	X	X	X	Load ($P_n \rightarrow Q_n$)
H	L	L	H	Count Up (Increment)
H	L	L	L	Count Down (Decrement)
H	H	X	X	No Change (Hold)
H	X	H	X	No Change (Hold)

H = HIGH Voltage Level
L = LOW Voltage Level
X = Immaterial

State Diagram

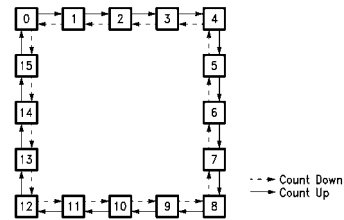

Logic Diagram

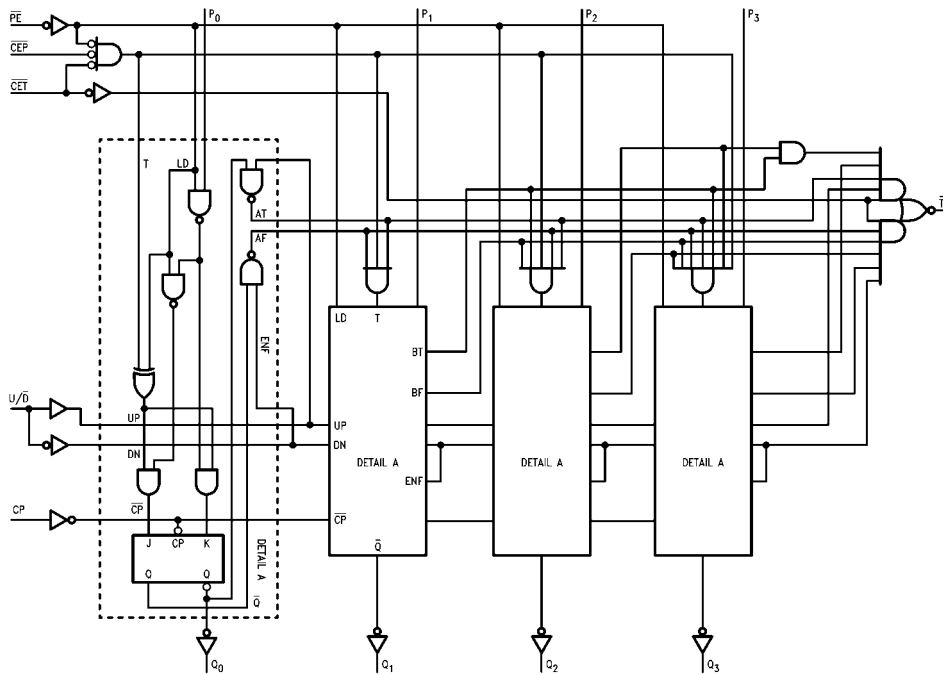

Please note that these diagrams are provided only for the understanding of logic operations and should not be used to estimate propagation delays.

Absolute Maximum Ratings (Note 1)

Storage Temperature	-65°C to +150°C
Ambient Temperature under Bias	-55°C to +125°C
Junction Temperature under Bias	-55°C to +150°C
V _{CC} Pin Potential to Ground Pin	-0.5V to +7.0V
Input Voltage (Note 2)	-0.5V to +7.0V
Input Current (Note 2)	-30 mA to +5.0 mA
Voltage Applied to Output in HIGH State (with V _{CC} = 0V)	
Standard Output	-0.5V to V _{CC}
3-STATE Output	-0.5V to +5.5V
Current Applied to Output in LOW State (Max)	twice the rated I _{OL} (mA)

Recommended Operating Conditions

Free Air Ambient Temperature	0°C to +70°C
Supply Voltage	+4.5V to +5.5V

Note 1: Absolute maximum ratings are values beyond which the device may be damaged or have its useful life impaired. Functional operation under these conditions is not implied.

Note 2: Either voltage limit or current limit is sufficient to protect inputs.

DC Electrical Characteristics

Symbol	Parameter	Min	Typ	Max	Units	V _{CC}	Conditions
V _{IH}	Input HIGH Voltage	2.0			V		Recognized as a HIGH Signal
V _{IL}	Input LOW Voltage			0.8	V		Recognized as a LOW Signal
V _{CD}	Input Clamp Diode Voltage			-1.2	V	Min	I _{IN} = -18 mA
V _{OH}	Output HIGH Voltage	10% V _{CC} 5% V _{CC}	2.5 2.7		V	Min	I _{OH} = -1 mA I _{OH} = -1 mA
V _{OL}	Output LOW Voltage	10% V _{CC}		0.5	V	Min	I _{OL} = 20 mA
I _{IH}	Input HIGH Current			5.0	μA	Max	V _{IN} = 2.7V
I _{BVI}	Input HIGH Current Breakdown Test			7.0	μA	Max	V _{IN} = 7.0V
I _{CEX}	Output HIGH Leakage Current			50	μA	Max	V _{OUT} = V _{CC}
V _{ID}	Input Leakage Test	4.75			V	0.0	I _{ID} = 1.9 μA All Other Pins Grounded
I _{OD}	Output Leakage Circuit Current			3.75	μA	0.0	V _{IOD} = 150 mV All Other Pins Grounded
I _{IL}	Input LOW Current			-0.6 -1.2	mA	Max	V _{IN} = 0.5V (except C _{ET}) V _{IN} = 0.5V (C _{ET})
I _{OS}	Output Short-Circuit Current	-60		-150	mA	Max	V _{OUT} = 0V
I _{CCL}	Power Supply Current		35	52	mA	Max	V _O = LOW

AC Electrical Characteristics									
Symbol	Parameter	$T_A = +25^\circ\text{C}$ $V_{CC} = +5.0\text{V}$ $C_L = 50\text{ pF}$			$T_A = -55^\circ\text{C to } +125^\circ\text{C}$ $V_{CC} = +5.0\text{V}$ $C_L = 50\text{ pF}$		$T_A = 0^\circ\text{C to } +70^\circ\text{C}$ $V_{CC} = +5.0\text{V}$ $C_L = 50\text{ pF}$		Units
		Min	Typ	Max	Min	Max	Min	Max	
f_{MAX}	Maximum Count Frequency	90			60		70		MHz
t_{PLH}	Propagation Delay	3.0	6.5	8.5	3.0	12.0	3.0	9.5	ns
t_{PHL}	CP to Q_n (\overline{PE} HIGH or LOW)	4.0	9.0	11.5	4.0	16.0	4.0	13.0	
t_{PLH}	Propagation Delay	5.5	12.0	15.5	5.5	20.0	5.5	17.5	ns
t_{PHL}	CP to \overline{TC}	4.0	8.5	12.5	4.0	15.0	4.0	13.0	
t_{PLH}	Propagation Delay	2.5	4.5	6.5	2.5	9.0	2.5	7.0	ns
t_{PHL}	\overline{CET} to \overline{TC}	2.5	8.5	11.0	2.5	12.0	2.5	12.0	
t_{PLH}	Propagation Delay	3.5	8.5	11.5	3.5	16.0	3.5	12.5	ns
t_{PHL}	U/\overline{D} to \overline{TC}	4.0	8.0	12.0	4.0	14.0	4.0	13.0	
AC Operating Requirements									
Symbol	Parameter	$T_A = +25^\circ\text{C}$ $V_{CC} = +5.0\text{V}$		$T_A = -55^\circ\text{C to } +125^\circ\text{C}$ $V_{CC} = +5.0\text{V}$		$T_A = 0^\circ\text{C to } +70^\circ\text{C}$ $V_{CC} = +5.0\text{V}$		Units	
		Min	Max	Min	Max	Min	Max		
$t_S(H)$	Setup Time, HIGH or LOW	4.0		4.5		4.5		ns	
$t_S(L)$	P_n to CP	4.0		4.5		4.5			
$t_H(H)$	Hold Time, HIGH or LOW	3.0		3.5		3.5		ns	
$t_H(L)$	P_n to CP	3.0		3.5		3.5			
$t_S(H)$	Setup Time, HIGH or LOW	7.0		8.0		8.0		ns	
$t_S(L)$	\overline{CEP} or \overline{CET} to CP	5.0		8.0		6.5			
$t_H(H)$	Hold Time, HIGH or LOW	0		0		0		ns	
$t_H(L)$	\overline{CEP} or \overline{CET} to CP	0.5		1.0		0.5			
$t_S(H)$	Setup Time, HIGH or LOW	8.0		10.0		9.0		ns	
$t_S(L)$	\overline{PE} to CP	8.0		10.0		9.0			
$t_H(H)$	Hold Time, HIGH or LOW	1.0		1.0		1.0		ns	
$t_H(L)$	\overline{PE} to CP	0		0		0			
$t_S(H)$	Setup Time, HIGH or LOW	11.0		14.0		12.5		ns	
$t_S(L)$	U/\overline{D} to CP	7.0		12.0		8.5			
$t_H(H)$	Hold Time, HIGH or LOW	0		0		0		ns	
$t_H(L)$	U/\overline{D} to CP	0		0		0			
$t_W(H)$	CP Pulse Width	4.0		6.0		4.5		ns	
$t_W(L)$	HIGH or LOW	7.0		9.0		8.0			

Physical Dimensions inches (millimeters) unless otherwise noted

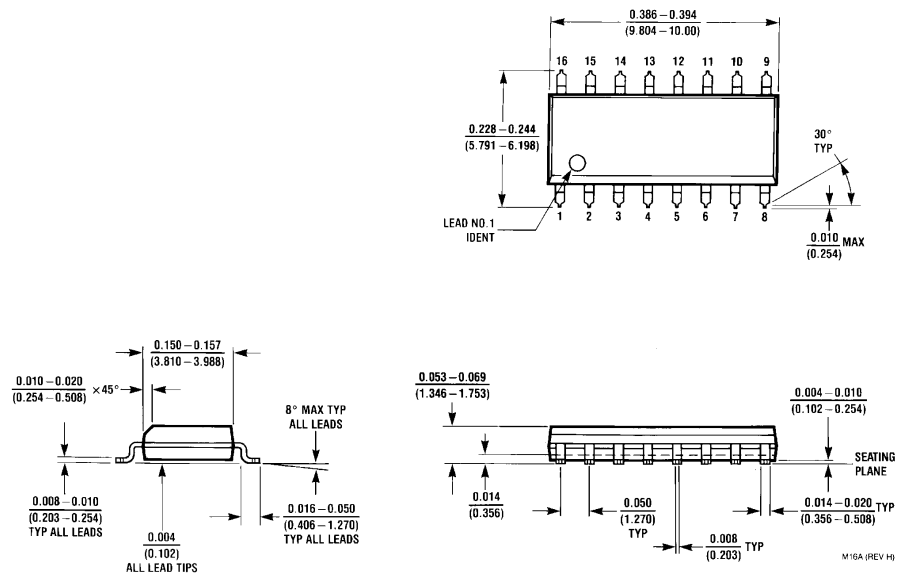

**16-Lead Small Outline Integrated Circuit (SOIC), JEDEC MS-012, 0.150 Narrow
Package Number M16A**

Physical Dimensions inches (millimeters) unless otherwise noted (Continued)

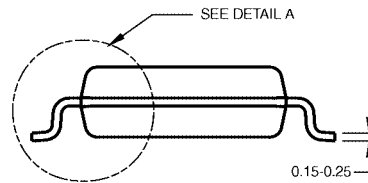
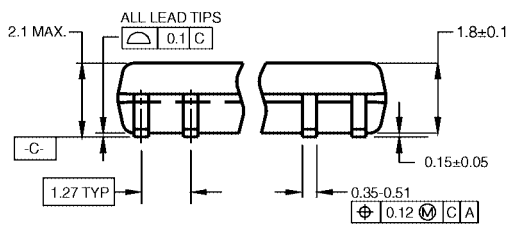
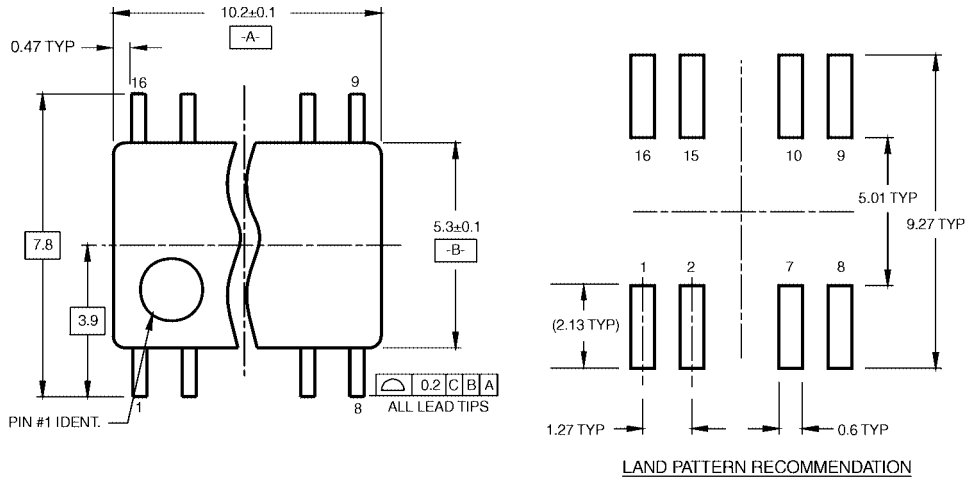

DIMENSIONS ARE IN MILLIMETERS

- NOTES:
 A. CONFORMS TO EIAJ EDR-7320 REGISTRATION, ESTABLISHED IN DECEMBER, 1998.
 B. DIMENSIONS ARE IN MILLIMETERS.
 C. DIMENSIONS ARE EXCLUSIVE OF BURRS, MOLD FLASH, AND TIE BAR EXTRUSIONS.

M16DRevB1



**16-Lead Small Outline Package (SOP), EIAJ TYPE II, 5.3mm Wide
 Package Number M16D**

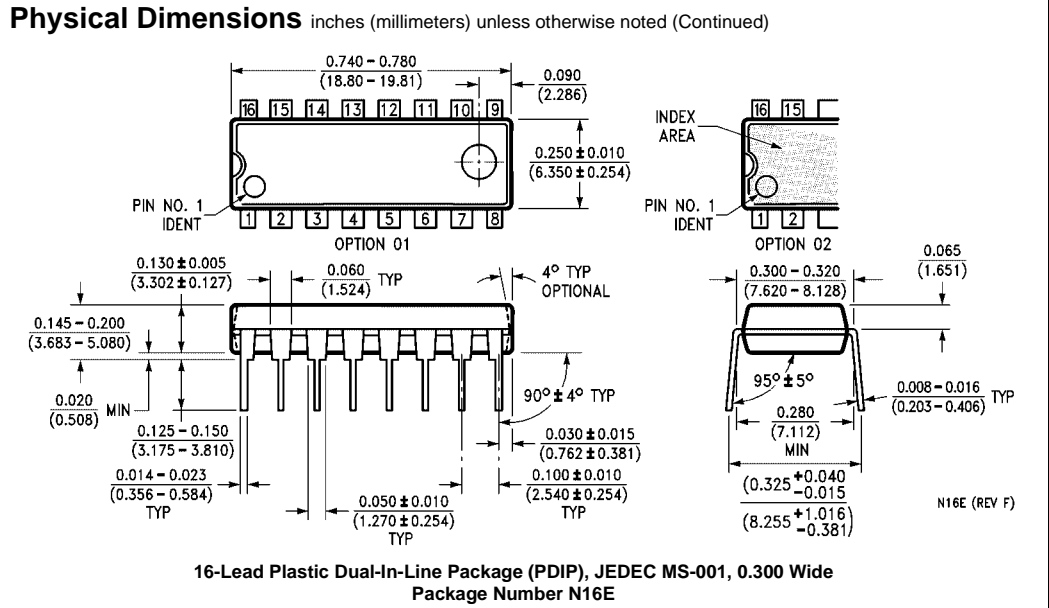

Fairchild does not assume any responsibility for use of any circuitry described, no circuit patent licenses are implied and Fairchild reserves the right at any time without notice to change said circuitry and specifications.

LIFE SUPPORT POLICY

FAIRCHILD'S PRODUCTS ARE NOT AUTHORIZED FOR USE AS CRITICAL COMPONENTS IN LIFE SUPPORT DEVICES OR SYSTEMS WITHOUT THE EXPRESS WRITTEN APPROVAL OF THE PRESIDENT OF FAIRCHILD SEMICONDUCTOR CORPORATION. As used herein:

1. Life support devices or systems are devices or systems which, (a) are intended for surgical implant into the body, or (b) support or sustain life, and (c) whose failure to perform when properly used in accordance with instructions for use provided in the labeling, can be reasonably expected to result in a significant injury to the user.
2. A critical component in any component of a life support device or system whose failure to perform can be reasonably expected to cause the failure of the life support device or system, or to affect its safety or effectiveness.

www.fairchildsemi.com

Looking for pricing, stock, or lifecycle information?

Click below to explore more details on WIN SOURCE:

-  [View 74F169SCX on WIN SOURCE](#)
-  [Fairchild/ON Semiconductor Information](#)

Optimize Your Supply Chain with WIN SOURCE Solutions

-  Global Sourcing Solution
-  Obsolete Management
-  Cost Control Management
-  Shortage Management
-  Alternative Solution
-  Excess Inventory Management