



**THE DATASHEET OF
SI9706DY**





PC Card (PCMCIA) Interface Switch

FEATURES

- Single SO-8 Package
- CMOS-Logic Compatible Inputs
- Slow V_{CC} Ramp Time
- Smart Switching
- Extremely Low R_{ON}
- Reverse Blocking Switches
- Low Power Consumption
- Safe Power Up

DESCRIPTION

The Si9706DY offers an integrated solution for PC Card power interfaces that only require V_{CC} switching. This part is ideal for systems that operate at 5 V and provide V_{PP} from the main supply or from a dedicated Flash RAM 12-V supply.

The Si9706DY operates off the 5-V supply and has built-in level shifting for gate drive. Internal logic protects against a control logic error that would short 5 V to the 3.3-V supply. This protection logic also allows the Si9706DY to be configured for

positive or negative control logic for compatibility with a variety of PC Card controllers. These control inputs are CMOS logic compatible and can be driven to 3.3 V or 5 V.

The Si9706DY PC Card interface switch is packaged in a narrow body SO-8 package and is rated over the industrial temperature range -40 to 85°C . The Si9706DY is available in lead free.

FUNCTIONAL BLOCK DIAGRAM

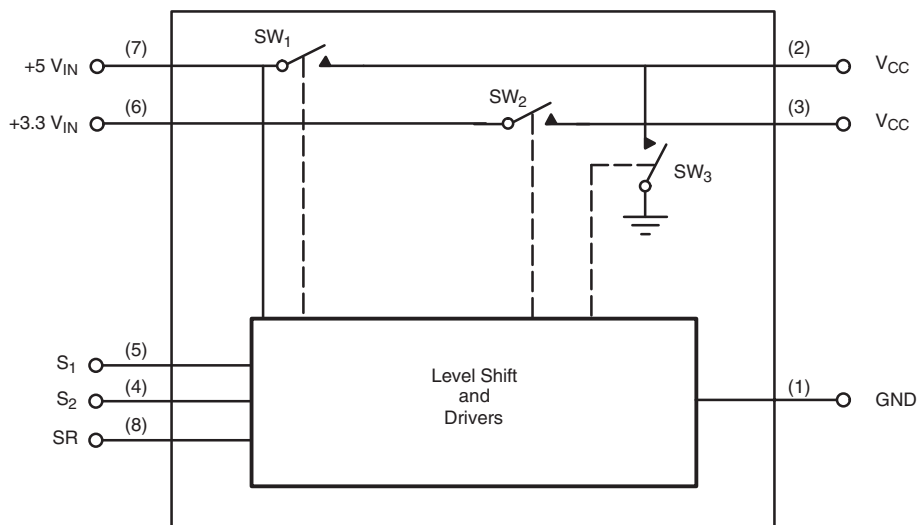



ABSOLUTE MAXIMUM RATINGS

Voltages Referenced to Ground	
+5 V _{IN}	7 V
+3.3 V _{IN}	7 V
S ₁ , S ₂ (CMOS Inputs)	7 V
All Pins	-0.5 V
I _{OUT} V _{CC} ^a	4 A

PD Max ^b : (T _A = 25°C)	1.59 W
(T _A = 85°C)	0.63 W
Junction Temperature	125°C
Thermal Ratings ^b : R _{θJA}	63 °C/W

Notes

- Pins 2, 3 connected together externally.
- Mounted on 1-IN², FR4 PC Board.

RECOMMENDED OPERATING CONDITIONS

+5 V _{IN} (must be present)	5 V ± 10%
+3.3 V _{IN}	3.3 V ± 10%
C _{SR}	33 nF
I _{OUT} V _{CC} ^a	2 A

V _{CC} Load Capacitance	150 μF Max
--	------------

Notes

- Pins 2, 3 connected together externally.

SPECIFICATIONS							
Parameter	Symbol	Test Conditions Unless Otherwise Specified C _{SR} = 33 nF, +5 V _{IN} = 5 V +3.3 V _{IN} = 3.3 V, Low ≤ 0.8 V, High ≥ 2.2 V		Limits			Unit
				Min ^a	Typ ^b	Max ^a	
Switch SW₁							
On-Resistance	R _{ON}	I = 500 mA, S ₁ = High S ₂ = Low	T _A = 25°C	58	70	mΩ	
			T _A = 85°C	73	90		
Off Current (V _{CC})	I _{OFF}	+5 V _{IN} = 5.5 V, V _{CC} = 0 V S ₁ = S ₂ = Low	T _A = 25°C		1	μA	
			T _A = 85°C		10		
Rise Time	t _{S1(on)}	S ₂ = Low, See Figure 1		0.2	1.7	ms	
Fall Time	t _{S1(off)}			10	30		50
Switch SW₂							
On-Resistance	R _{ON}	I = 500 mA, S ₂ = High S ₁ = Low	T _A = 25°C	44	55	mΩ	
			T _A = 85°C	55	70		
Off Current (+3.3 V _{IN})	I _{OFF}	+3.3 V _{IN} = 3.6 V, V _{CC} = 0 V S ₁ = S ₂ = Low	T _A = 25°C		1	μA	
			T _A = 85°C		10		
Rise Time	t _{S2(on)}	S ₁ = Low, See Figure 1		0.1	0.9	ms	
Fall Time	t _{S2(off)}			5	20		40
Switch SW₃							
On-Resistance	R _{ON}	I = 2 mA, S ₁ = S ₂ = Low	T _A = 25°C	140	400	Ω	
			T _A = 85°C	200	500		
Power Supply							
+5 V _{IN} Current Input (on)	I _{+5VIN(1)}	S ₁ = 0 V, S ₂ = 3 V		20	50	μA	
	I _{+5VIN(2)}	S ₁ = 3 V, S ₂ = 0 V		20	50		
+5 V _{IN} Current Input (off)	I _{+5VIN(3)}	S ₁ = S ₂ = 0 V		< 1	10		
Input Voltage High	V _{I(H)}	+5 V _{IN} = 5.5 V	2.2	1.8	V		
		+5 V _{IN} = 4.5 V	2.2	1.6			
Input Voltage Low	V _{I(L)}	+5 V _{IN} = 5.5 V		1.6	0.8		
		+5 V _{IN} = 4.5 V		1.4	0.8		
Input Current High	I _{I(H)}	S ₁ , S ₂ = 5 V			1.0	μA	
Input Current Low	I _{I(L)}	S ₁ , S ₂ = GND	-1.0				

Notes

- The algebraic convention whereby the most negative value is a minimum and the most positive a maximum.
- Typical values are for DESIGN AID ONLY, not guaranteed nor subject to production testing.

TIMING WAVEFORMS

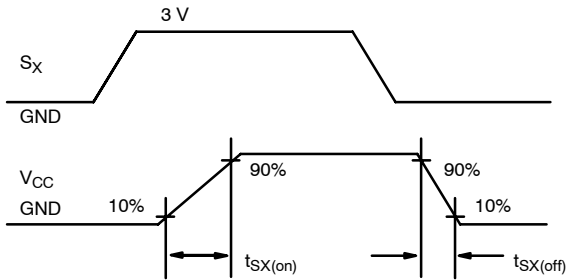

FIGURE 1. Switch Ramp

TRUTH TABLE

S_1	S_2	Switch 1	Switch 2	Switch 3
0	0	Off	Off	On
0	1	Off	On	Off
1	0	On	Off	Off
1	1	Off	Off	On

Notes

- The smart switching of the Si9706DY avoids potential host damage by defaulting to off during error conditions.

PIN CONFIGURATION AND DESCRIPTION

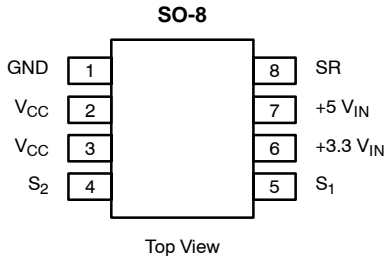

Pin	Function	Description
1	GND	Ground connection.
2, 3	V_{CC}	Supply voltage to slot.
4	S_2	Control input for selecting $+3.3 V_{IN}$ to V_{CC} .
5	S_1	Control input for selecting $+5 V_{IN}$ to V_{CC} .
6	$+3.3 V_{IN}$	$+3.3$ -V supply.
7	$+5 V_{IN}$	$+5$ -V supply.
8	SR	Slew rate control pin.

ORDERING INFORMATION

Part Number	Temperature Range
Si9706DY-T1	-40 to 85°C
Si9706DY-T1-E3 (Lead Free)	

TYPICAL CHARACTERISTICS (25°C UNLESS OTHERWISE NOTED)

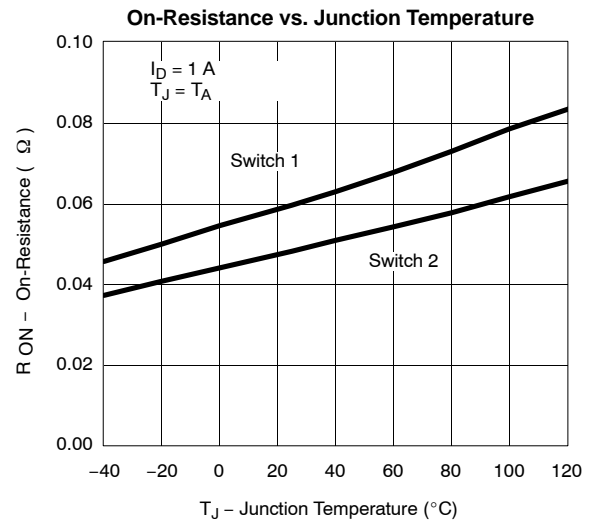
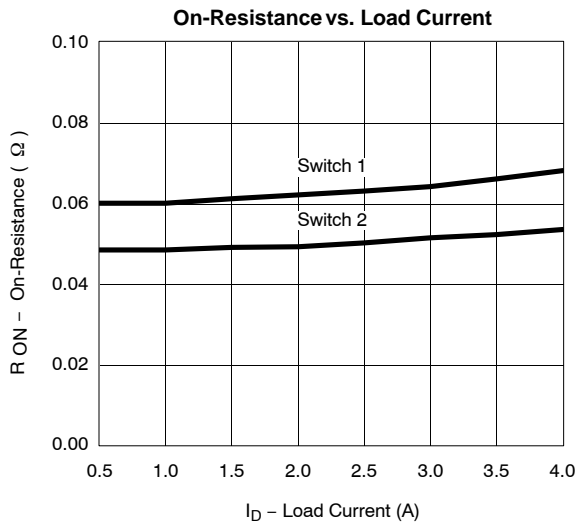

TYPICAL CHARACTERISTICS (25 °C UNLESS OTHERWISE NOTED)

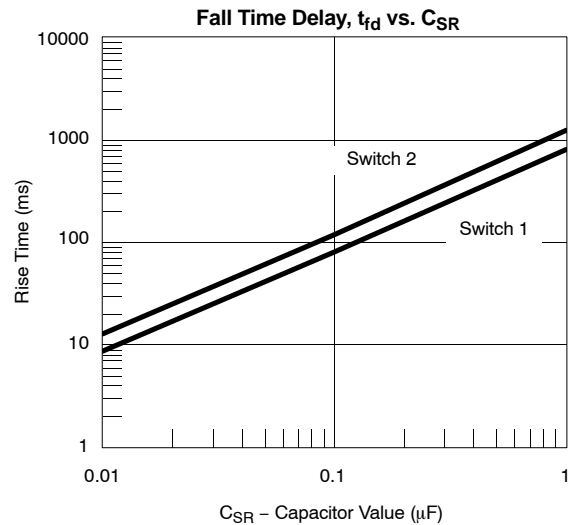
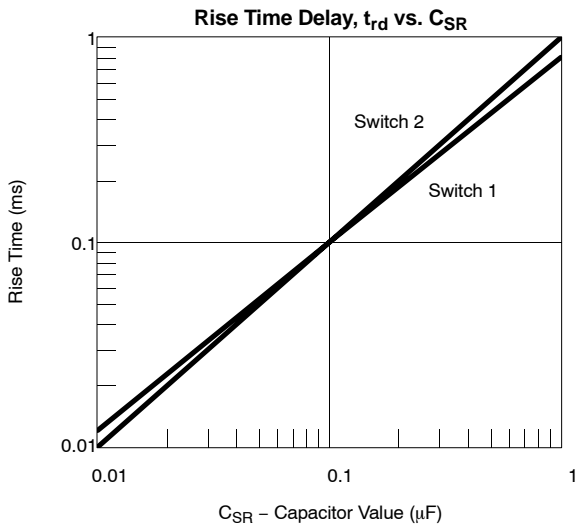
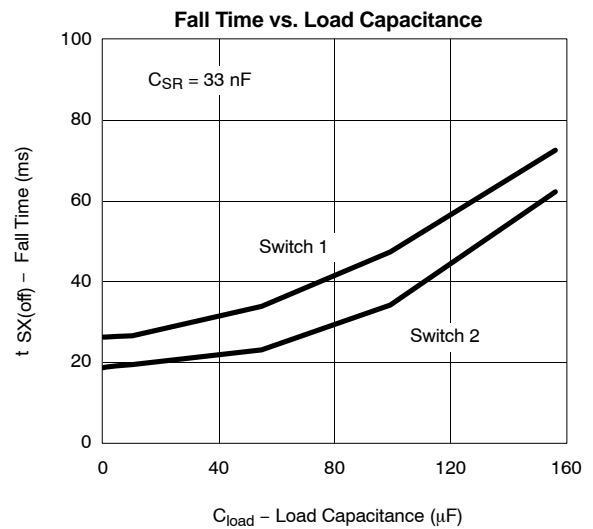
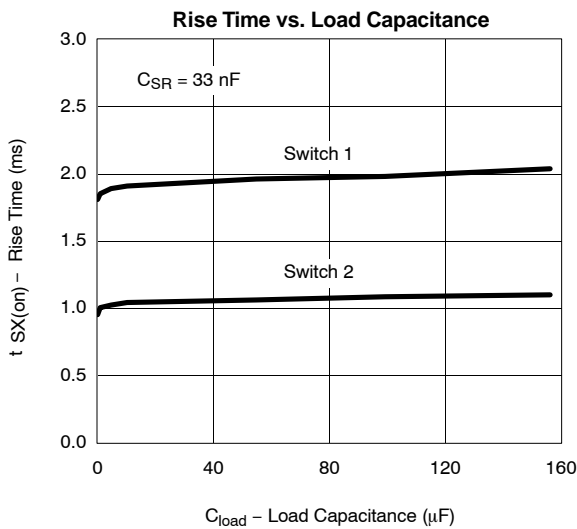
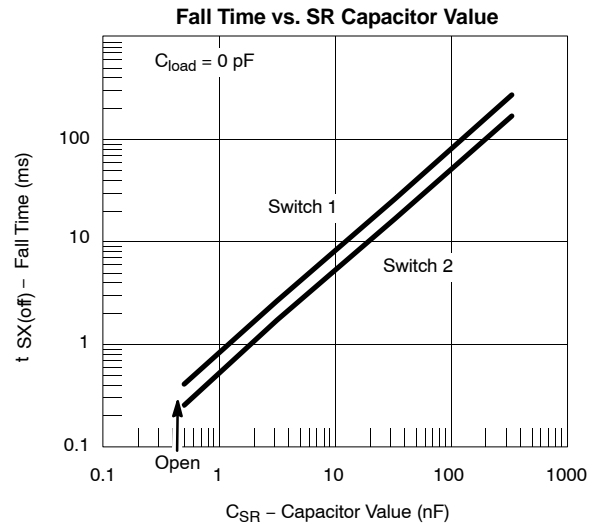
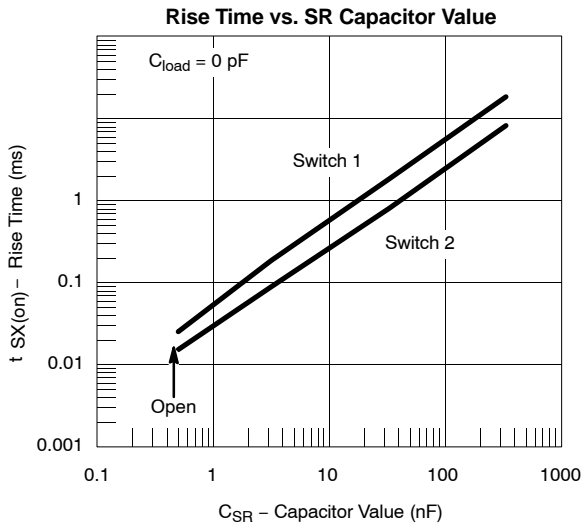

SOIC (NARROW): 8-LEAD

JEDEC Part Number: MS-012



DIM	MILLIMETERS		INCHES	
	Min	Max	Min	Max
A	1.35	1.75	0.053	0.069
A ₁	0.10	0.20	0.004	0.008
B	0.35	0.51	0.014	0.020
C	0.19	0.25	0.0075	0.010
D	4.80	5.00	0.189	0.196
E	3.80	4.00	0.150	0.157
e	1.27 BSC		0.050 BSC	
H	5.80	6.20	0.228	0.244
h	0.25	0.50	0.010	0.020
L	0.50	0.93	0.020	0.037
q	0°	8°	0°	8°
S	0.44	0.64	0.018	0.026
ECN: C-06527-Rev. I, 11-Sep-06				
DWG: 5498				



Disclaimer

ALL PRODUCT, PRODUCT SPECIFICATIONS AND DATA ARE SUBJECT TO CHANGE WITHOUT NOTICE TO IMPROVE RELIABILITY, FUNCTION OR DESIGN OR OTHERWISE.

Vishay Intertechnology, Inc., its affiliates, agents, and employees, and all persons acting on its or their behalf (collectively, "Vishay"), disclaim any and all liability for any errors, inaccuracies or incompleteness contained in any datasheet or in any other disclosure relating to any product.

Vishay makes no warranty, representation or guarantee regarding the suitability of the products for any particular purpose or the continuing production of any product. To the maximum extent permitted by applicable law, Vishay disclaims (i) any and all liability arising out of the application or use of any product, (ii) any and all liability, including without limitation special, consequential or incidental damages, and (iii) any and all implied warranties, including warranties of fitness for particular purpose, non-infringement and merchantability.

Statements regarding the suitability of products for certain types of applications are based on Vishay's knowledge of typical requirements that are often placed on Vishay products in generic applications. Such statements are not binding statements about the suitability of products for a particular application. It is the customer's responsibility to validate that a particular product with the properties described in the product specification is suitable for use in a particular application. Parameters provided in datasheets and / or specifications may vary in different applications and performance may vary over time. All operating parameters, including typical parameters, must be validated for each customer application by the customer's technical experts. Product specifications do not expand or otherwise modify Vishay's terms and conditions of purchase, including but not limited to the warranty expressed therein.

Except as expressly indicated in writing, Vishay products are not designed for use in medical, life-saving, or life-sustaining applications or for any other application in which the failure of the Vishay product could result in personal injury or death. Customers using or selling Vishay products not expressly indicated for use in such applications do so at their own risk. Please contact authorized Vishay personnel to obtain written terms and conditions regarding products designed for such applications.

No license, express or implied, by estoppel or otherwise, to any intellectual property rights is granted by this document or by any conduct of Vishay. Product names and markings noted herein may be trademarks of their respective owners.

Looking for pricing, stock, or lifecycle information?

Click below to explore more details on WIN SOURCE:

 [View S19706DY on WIN SOURCE](#)

 [Vishay Information](#)

Optimize Your Supply Chain with WIN SOURCE Solutions

-  Global Sourcing Solution
-  Obsolete Management
-  Cost Control Management
-  Shortage Management
-  Alternative Solution
-  Excess Inventory Management