



**THE DATASHEET OF
SI7020-A10-GM1R**



I²C HUMIDITY AND TEMPERATURE SENSOR

Features

- Precision Relative Humidity Sensor
 - ± 4% RH (max), 0–80% RH
- High Accuracy Temperature Sensor
 - ±0.4 °C (max), –10 to 85 °C
- 0 to 100% RH operating range
- Up to –40 to +125 °C operating range
- Wide operating voltage (1.9 to 3.6 V)
- Low Power Consumption
 - 150 µA active current
 - 60 nA standby current
- Factory-calibrated
- I²C Interface
- Integrated on-chip heater
- 3x3 mm DFN Package
- Excellent long term stability
- Optional factory-installed cover
 - Low-profile
 - Protection during reflow
 - Excludes liquids and particulates

Applications

- HVAC/R
- Thermostats/humidistats
- Respiratory therapy
- White goods
- Indoor weather stations
- Micro-environments/data centers
- Automotive climate control and defogging
- Asset and goods tracking
- Mobile phones and tablets

Description

The Si7020 I²C Humidity and Temperature Sensor is a monolithic CMOS IC integrating humidity and temperature sensor elements, an analog-to-digital converter, signal processing, calibration data, and an I²C Interface. The patented use of industry-standard, low-K polymeric dielectrics for sensing humidity enables the construction of low-power, monolithic CMOS Sensor ICs with low drift and hysteresis, and excellent long term stability.

The humidity and temperature sensors are factory-calibrated and the calibration data is stored in the on-chip non-volatile memory. This ensures that the sensors are fully interchangeable, with no recalibration or software changes required.

The Si7020 is available in a 3x3 mm DFN package and is reflow solderable. It can be used as a hardware- and software-compatible drop-in upgrade for existing RH/temperature sensors in 3x3 mm DFN-6 packages, featuring precision sensing over a wider range and lower power consumption. The optional factory-installed cover offers a low profile, convenient means of protecting the sensor during assembly (e.g., reflow soldering) and throughout the life of the product, excluding liquids (hydrophobic/oleophobic) and particulates.

The Si7020 offers an accurate, low-power, factory-calibrated digital solution ideal for measuring humidity, dew-point, and temperature, in applications ranging from HVAC/R and asset tracking to industrial and consumer platforms.

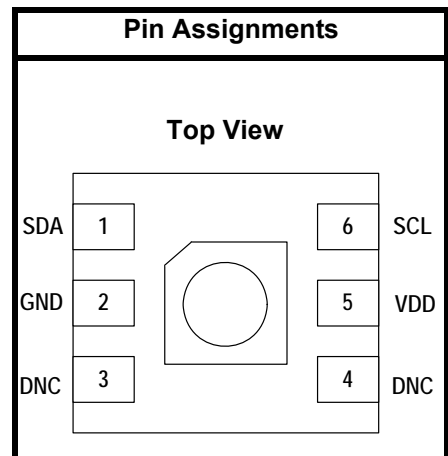

Patent Protected. Patents pending

Si7020-A10

Functional Block Diagram

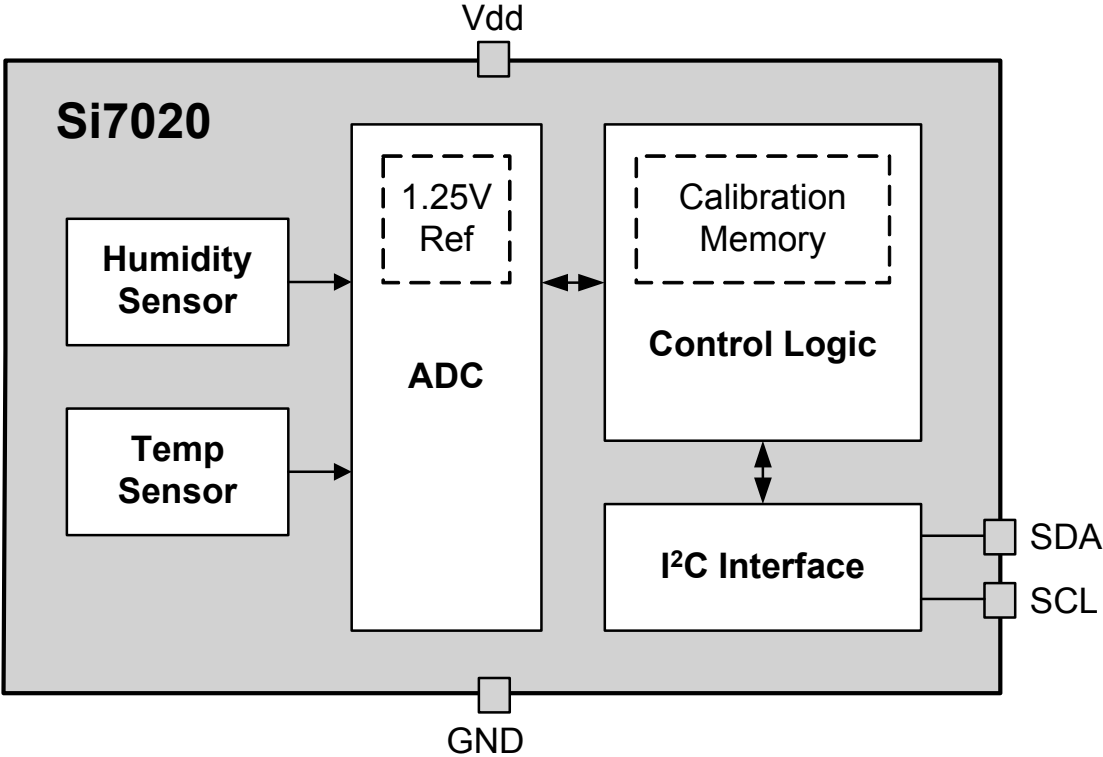

TABLE OF CONTENTS

<u>Section</u>	<u>Page</u>
1. Electrical Specifications	4
2. Typical Application Circuits	12
3. Bill of Materials	13
4. Functional Description	14
4.1. Relative Humidity Sensor Accuracy	15
4.2. Hysteresis	16
4.3. Prolonged Exposure to High Humidity	16
4.4. PCB Assembly	16
4.5. Protecting the Sensor	18
4.6. Bake/Hydrate Procedure	18
4.7. Long Term Drift/Aging	18
5. I²C Interface	19
5.1. Issuing a Measurement Command	20
5.2. Reading and Writing User Registers	24
5.3. Electronic Serial Number	24
5.4. Firmware Revision	25
5.5. Heater	25
6. Control Register	26
6.1. Register Descriptions	26
7. Pin Descriptions: Si7020 (Top View)	27
8. Ordering Guide	28
9. Package Outline	29
9.1. Package Outline: 3x3 6-pin DFN	29
9.2. Package Outline: 3x3 6-pin DFN with Protective Cover	30
10. PCB Land Pattern and Solder Mask Design	31
11. Top Marking	32
11.1. Si7020 Top Marking	32
11.2. Top Marking Explanation	32
12. Additional Reference Resources	32
Document Change List	33
Contact Information	34

Si7020-A10

1. Electrical Specifications

Unless otherwise specified, all min/max specifications apply over the recommended operating conditions.

Table 1. Recommended Operating Conditions

Parameter	Symbol	Test Condition	Min	Typ	Max	Unit
Power Supply	V _{DD}		1.9		3.6	V
Operating Temperature	T _A	I and Y grade	-40	—	+125	°C
Operating Temperature	T _A	G grade	-40	—	+85	°C

Table 2. General Specifications

1.9 ≤ V_{DD} ≤ 3.6 V; T_A = -40 to 85 °C (G grade) or -40 to 125 °C (I/Y grade); default conversion time unless otherwise noted.

Parameter	Symbol	Test Condition	Min	Typ	Max	Unit
Input Voltage High	V _{IH}	SCL, SDA pins	0.7xV _{DD}	—	—	V
Input Voltage Low	V _{IL}	SCL, SDA pins	—	—	0.3xV _{DD}	V
Input Voltage Range	V _{IN}	SCL, SDA pins with respect to GND	0.0	—	V _{DD}	V
Input Leakage	I _{IL}	SCL, SDA pins	—	—	1	μA
Output Voltage Low	V _{OL}	SDA pin; I _{OL} = 2.5 mA; V _{DD} = 3.3 V	—	—	0.6	V
		SDA pin; I _{OL} = 1.2 mA; V _{DD} = 1.9 V	—	—	0.4	V
Current Consumption	I _{DD}	RH conversion in progress	—	150	180	μA
		Temperature conversion in progress	—	90	120	μA
		Standby, -40 to +85 °C ²	—	0.06	0.62	μA
		Standby, -40 to +125 °C ²	—	0.06	3.8	μA
		Peak I _{DD} during powerup ³	—	3.5	4.0	mA
		Peak I _{DD} during I ² C operations ⁴	—	3.5	4.0	mA
Heater Current ⁶	I _{HEAT}	After writing to user registers ⁵	—	20	—	μA
			—	3.1	—	mA

Notes:

1. Initiating a RH measurement will also automatically initiate a temperature measurement. The total conversion time will be t_{CONV(RH)} + t_{CONV(T)}.
2. No conversion or I²C transaction in progress. Typical values measured at 25 °C.
3. Occurs once during powerup. Duration is <5 msec.
4. Occurs during I²C commands for Reset, Read/Write User Registers, Read EID, and Read Firmware Version. Duration is <100 μs when I²C clock speed is >100 kHz (>200 kHz for 2-byte commands).
5. I_{DD} after a user register write. Initiating any other subsequent I²C transaction on the same bus (such as the user register read, starting an RH measurement, or traffic directed at other I²C devices) will transition the device to standby mode.
6. Additional current consumption when HTRE bit enabled. See section “5.5. Heater” for more information

Table 2. General Specifications (Continued)

$1.9 \leq V_{DD} \leq 3.6$ V; $T_A = -40$ to 85 °C (G grade) or -40 to 125 °C (I/Y grade); default conversion time unless otherwise noted.

Parameter	Symbol	Test Condition	Min	Typ	Max	Unit
Conversion Time ¹	t_{CONV}	12-bit RH	—	10	12	ms
		11-bit RH	—	5.8	7	
		10-bit RH	—	3.7	4.5	
		8-bit RH	—	2.6	3.1	
		14-bit temperature	—	7	10.8	
		13-bit temperature	—	4	6.2	
		12-bit temperature	—	2.4	3.8	
		11-bit temperature	—	1.5	2.4	
Powerup Time	t_{PU}	From $V_{DD} \geq 1.9$ V to ready for a conversion, 25 °C	—	18	25	ms
		From $V_{DD} \geq 1.9$ V to ready for a conversion, full temperature range	—	—	80	
		After issuing a software reset command	—	5	15	

Notes:

1. Initiating a RH measurement will also automatically initiate a temperature measurement. The total conversion time will be $t_{CONV(RH)} + t_{CONV(T)}$.
2. No conversion or I²C transaction in progress. Typical values measured at 25 °C.
3. Occurs once during powerup. Duration is <5 msec.
4. Occurs during I²C commands for Reset, Read/Write User Registers, Read EID, and Read Firmware Version. Duration is <100 μ s when I²C clock speed is >100 kHz (>200 kHz for 2-byte commands).
5. IDD after a user register write. Initiating any other subsequent I²C transaction on the same bus (such as the user register read, starting an RH measurement, or traffic directed at other I²C devices) will transition the device to standby mode.
6. Additional current consumption when HTRE bit enabled. See section "5.5. Heater" for more information

Si7020-A10

Table 3. I²C Interface Specifications¹

1.9 ≤ V_{DD} ≤ 3.6 V; T_A = -40 to +85 °C (G grade) or -40 to +125 °C (I/Y grade) unless otherwise noted.

Parameter	Symbol	Test Condition	Min	Typ	Max	Unit
Hysteresis	V _{HYS}	High-to-low versus low-to-high transition	0.05 x V _{DD}	—	—	V
SCLK Frequency ²	f _{SCL}		—	—	400	kHz
SCL High Time	t _{SKH}		0.6	—	—	μs
SCL Low Time	t _{SKL}		1.3	—	—	μs
Start Hold Time	t _{STH}		0.6	—	—	μs
Start Setup Time	t _{STS}		0.6	—	—	μs
Stop Setup Time	t _{SPS}		0.6	—	—	μs
Bus Free Time	t _{BUF}	Between Stop and Start	1.3	—	—	μs
SDA Setup Time	t _{DS}		100	—	—	ns
SDA Hold Time	t _{DH}		100	—	—	ns
SDA Valid Time	t _{VD;DAT}	From SCL low to data valid	—	—	0.9	μs
SDA Acknowledge Valid Time	t _{VD;ACK}	From SCL low to data valid	—	—	0.9	μs
Suppressed Pulse Width ³	t _{SPS}		50	—	—	ns

Notes:

1. All values are referenced to V_{IL} and/or V_{IH}.
2. Depending on the conversion command, the Si7020 may hold the master during the conversion (clock stretch). At above 100 kHz SCL, the Si7020 may also hold the master briefly for user register and device ID transactions. At the highest I²C speed of 400 kHz the stretching will be <50 μs.
3. Pulses up to and including 50 ns will be suppressed.

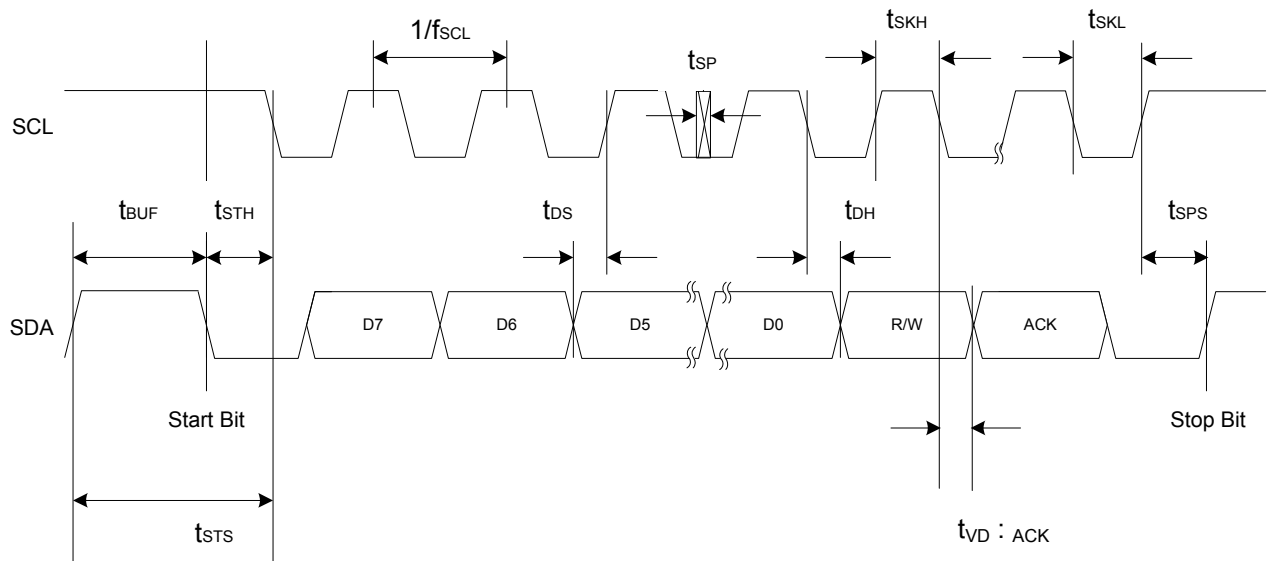

Figure 1. I²C Interface Timing Diagram

Table 4. Humidity Sensor

$1.9 \leq V_{DD} \leq 3.6$ V; $T_A = 30$ °C; default conversion time unless otherwise noted.

Parameter	Symbol	Test Condition	Min	Typ	Max	Unit
Operating Range ¹		Non-condensing	0	—	100	%RH
Accuracy ^{2, 3}		0 – 80% RH	—	±3	±4	%RH
		80 – 100% RH	See Figure 2			
Repeatability/Noise		12-bit resolution	—	0.025	—	%RH RMS
		11-bit resolution	—	0.05	—	
		10-bit resolution	—	0.1	—	
		8-bit resolution	—	0.2	—	
Response Time ⁴	$T_{63\%}$	1 m/s airflow	—	18	—	S
Drift vs. Temperature			—	0.05	—	%RH/°C
Hysteresis			—	±1	—	%RH
Long Term Stability ³			—	≤ 0.25	—	%RH/yr

Notes:

1. Recommended humidity operating range is 20% to 80% RH (non-condensing) over –10 °C to 60 °C. Prolonged operation beyond these ranges may result in a shift of sensor reading, with slow recovery time.
2. Excludes hysteresis, long term drift, and certain other factors and is applicable to non-condensing environments only. See section “4.1. Relative Humidity Sensor Accuracy” for more details.
3. Drift due to aging effects at typical room conditions of 30 °C and 30% to 50% RH. May be impacted by dust, vaporized solvents or other contaminants, e.g., out-gassing tapes, adhesives, packaging materials, etc. See section “4.7. Long Term Drift/Aging” .
4. Response time to a step change in RH. Time for the RH output to change by 63% of the total RH change.

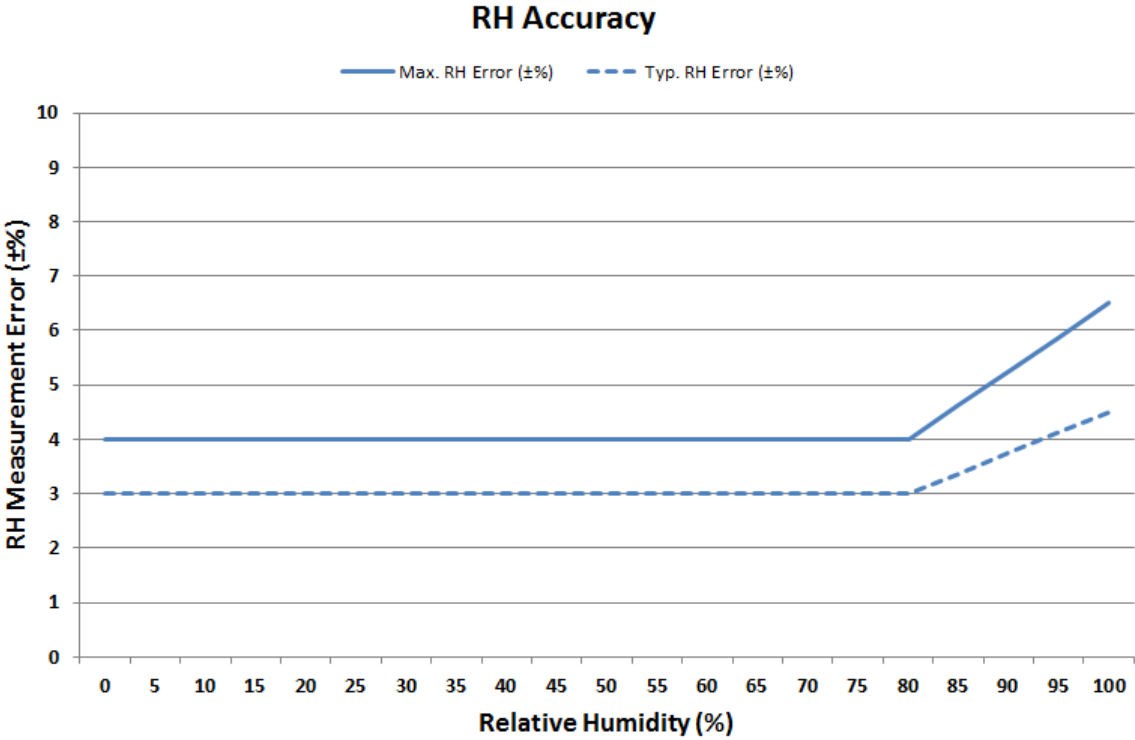

Figure 2. RH Accuracy at 30 °C

Table 5. Temperature Sensor

$1.9 \leq V_{DD} \leq 3.6$ V; $T_A = -40$ to $+85$ °C (G grade) or -40 to $+125$ °C (I/Y grade) default conversion time, unless otherwise noted.

Parameter	Symbol	Test Condition	Min	Typ	Max	Unit
Operating Range		I and Y Grade	-40	—	+125	°C
		G Grade	-40	—	+85	°C
Accuracy ¹		$-10 \text{ °C} \leq t_A \leq 85 \text{ °C}$	—	±0.3	±0.4	°C
		$-40 \leq t_A \leq 125 \text{ °C}$	Figure 3			
Repeatability/Noise		14-bit resolution	—	0.01	—	°C RMS
		13-bit resolution	—	0.02	—	
		12-bit resolution	—	0.04	—	
		11-bit resolution	—	0.08	—	
Response Time ²	$T_{63\%}$	Unmounted device	—	0.7	—	s
		Si7020-EB board	—	5.1	—	s
Long Term Stability			—	≤ 0.01	—	°C/Yr

Notes:

1. 14b measurement resolution (default).
2. Time to reach 63% of final value in response to a step change in temperature. Actual response time will vary dependent on system thermal mass and air-flow.

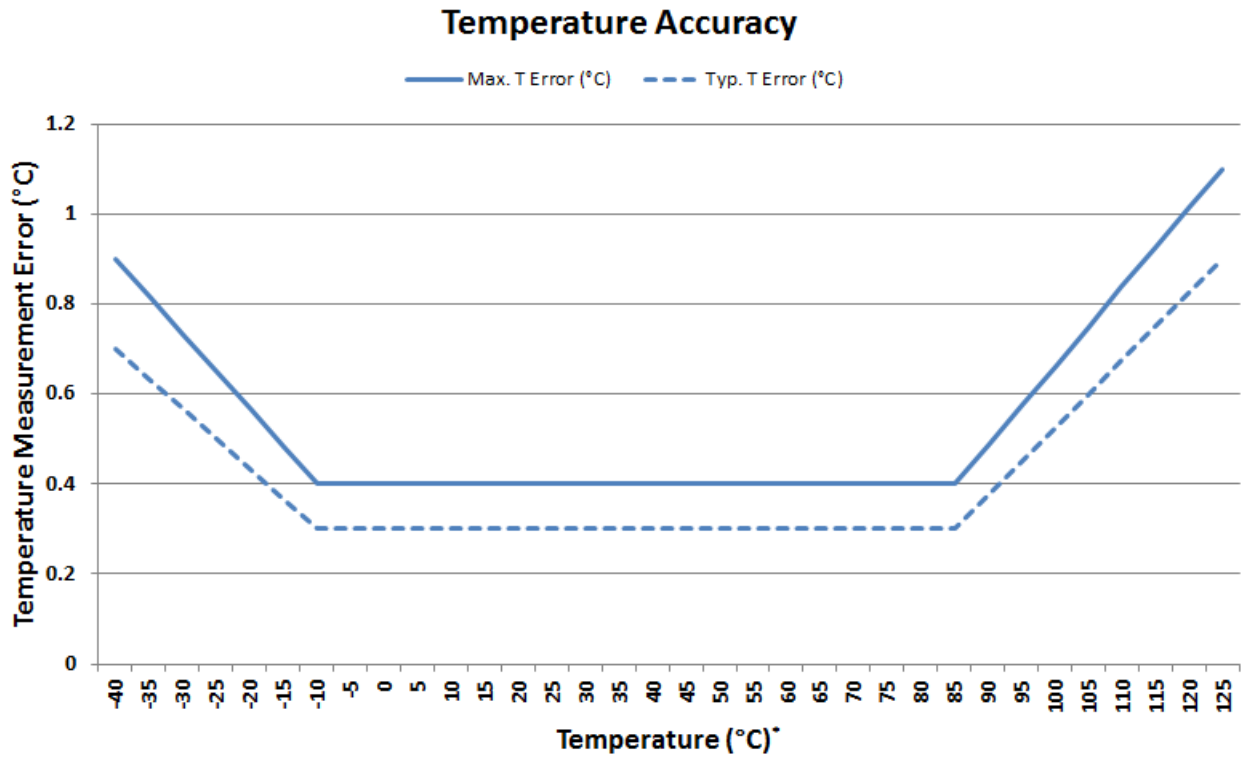

Figure 3. Temperature Accuracy*

*Note: Applies only to I and Y grade devices beyond +85 °C.

Table 6. Thermal Characteristics

Parameter	Symbol	Test Condition	DFN-6	Unit
Junction to Air Thermal Resistance	θ_{JA}	JEDEC 2-Layer board, No Airflow	256	°C/W
Junction to Air Thermal Resistance	θ_{JA}	JEDEC 2-Layer board, 1 m/s Airflow	224	°C/W
Junction to Air Thermal Resistance	θ_{JA}	JEDEC 2-Layer board, 2.5 m/s Airflow	205	°C/W
Junction to Case Thermal Resistance	θ_{JC}	JEDEC 2-Layer board	22	°C/W
Junction to Board Thermal Resistance	θ_{JB}	JEDEC 2-Layer board	134	°C/W

Table 7. Absolute Maximum Ratings¹

Parameter	Symbol	Test Condition	Min	Typ	Max	Unit
Ambient temperature under bias			-55	—	125	°C
Storage Temperature ²			-65	—	150	°C
Voltage on I/O pins			-0.3	—	VDD+0.3V	V
Voltage on VDD with respect to GND			-0.3		4.2	V
ESD Tolerance		HBM	—	—	2	kV
		CDM	—	—	1.25	kV
		MM	—	—	250	V

Notes:

1. Absolute maximum ratings are stress ratings only, operation at or beyond these conditions is not implied and may shorten the life of the device or alter its performance.
2. Special handling considerations apply; see application note, "AN607: Si70xx Humidity Sensor Designer's Guide".

Si7020-A10

2. Typical Application Circuits

The primary function of the Si7020 is to measure relative humidity and temperature. Figure 4 demonstrates the typical application circuit to achieve these functions.

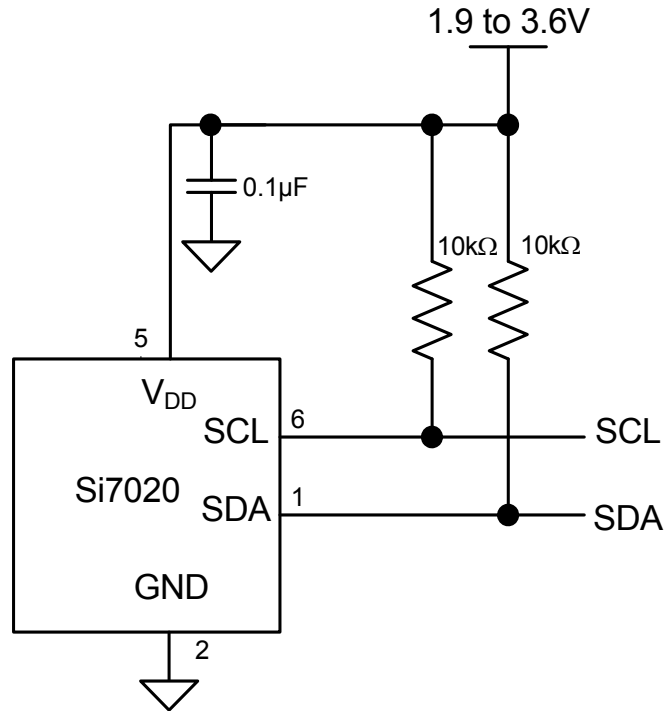

Figure 4. Typical Application Circuit for Relative Humidity and Temperature Measurement

3. Bill of Materials

Table 8. Typical Application Circuit BOM for Relative Humidity and Temperature Measurement

Reference	Description	Mfr Part Number	Manufacturer
R1	Resistor, 10 k Ω , \pm 5%, 1/16 W, 0603	CR0603-16W-103JT	Venkel
R2	Resistor, 10 k Ω , \pm 5%, 1/16 W, 0603	CR0603-16W-103JT	Venkel
C1	Capacitor, 0.1 μ F, 16 V, X7R, 0603	C0603X7R160-104M	Venkel
U1	IC, Digital Temperature/humidity Sensor	Si7020-A10-GM	Silicon Labs

4. Functional Description

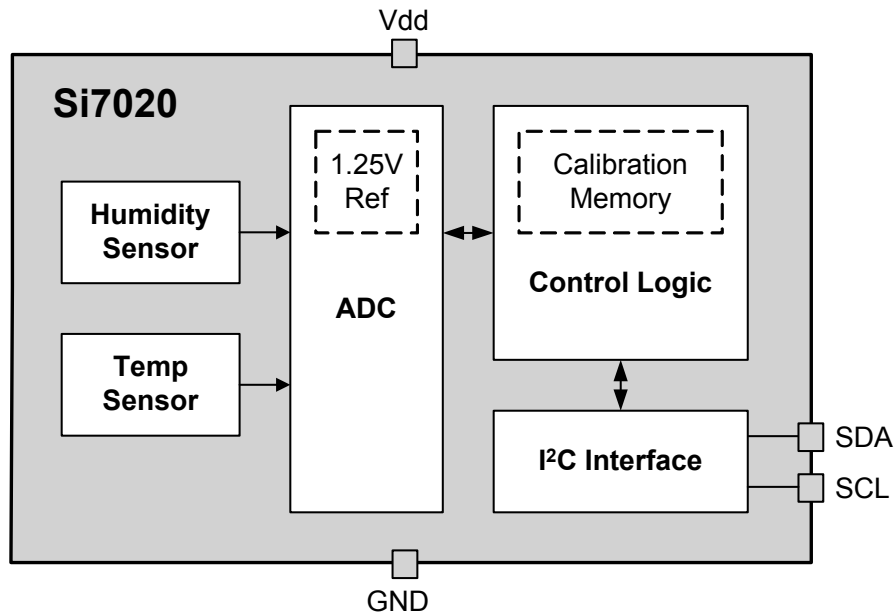

Figure 5. Si7020 Block Diagram

The Si7020 is a digital relative humidity and temperature sensor that integrates temperature and humidity sensor elements, an analog-to-digital converter, signal processing, calibration, polynomial non-linearity correction, and an I²C interface all in a single chip. The Si7020 is individually factory-calibrated for both temperature and humidity, with the calibration data stored in on-chip non-volatile memory. This ensures that the sensor is fully interchangeable, with no recalibration or changes to software required. Patented use of industry-standard CMOS and low-K dielectrics as a sensor enables the Si7020 to achieve excellent long term stability and immunity to contaminants with low drift and hysteresis. The Si7020 offers a low power, high accuracy, calibrated and stable solution ideal for a wide range of temperature, humidity, and dew-point applications including medical and instrumentation, high reliability automotive and industrial systems, and cost-sensitive consumer electronics.

While the Si7020 is largely a conventional mixed-signal CMOS integrated circuit, relative humidity sensors in general and those based on capacitive sensing using polymeric dielectrics have unique application and use requirements that are not common to conventional (non-sensor) ICs. Chief among those are:

- The need to protect the sensor during board assembly, i.e., solder reflow, and the need to subsequently rehydrate the sensor.
- The need to protect the sensor from damage or contamination during the product life-cycle.
- The impact of prolonged exposure to extremes of temperature and/or humidity and their potential effect on sensor accuracy.
- The effects of humidity sensor “memory”.

Each of these items is discussed in more detail in the following sections.

4.1. Relative Humidity Sensor Accuracy

To determine the accuracy of a relative humidity sensor, it is placed in a temperature and humidity controlled chamber. The temperature is set to a convenient fixed value (typically 25–30 °C) and the relative humidity is swept from 20 to 80% and back to 20% in the following steps: 20% – 40% – 60% – 80% – 80% – 60% – 40% – 20%. At each set-point, the chamber is allowed to settle for a period of 60 minutes before a reading is taken from the sensor. Prior to the sweep, the device is allowed to stabilize to 50%RH. The solid trace in Figure 6, “Measuring Sensor Accuracy Including Hysteresis,” shows the result of a typical sweep.

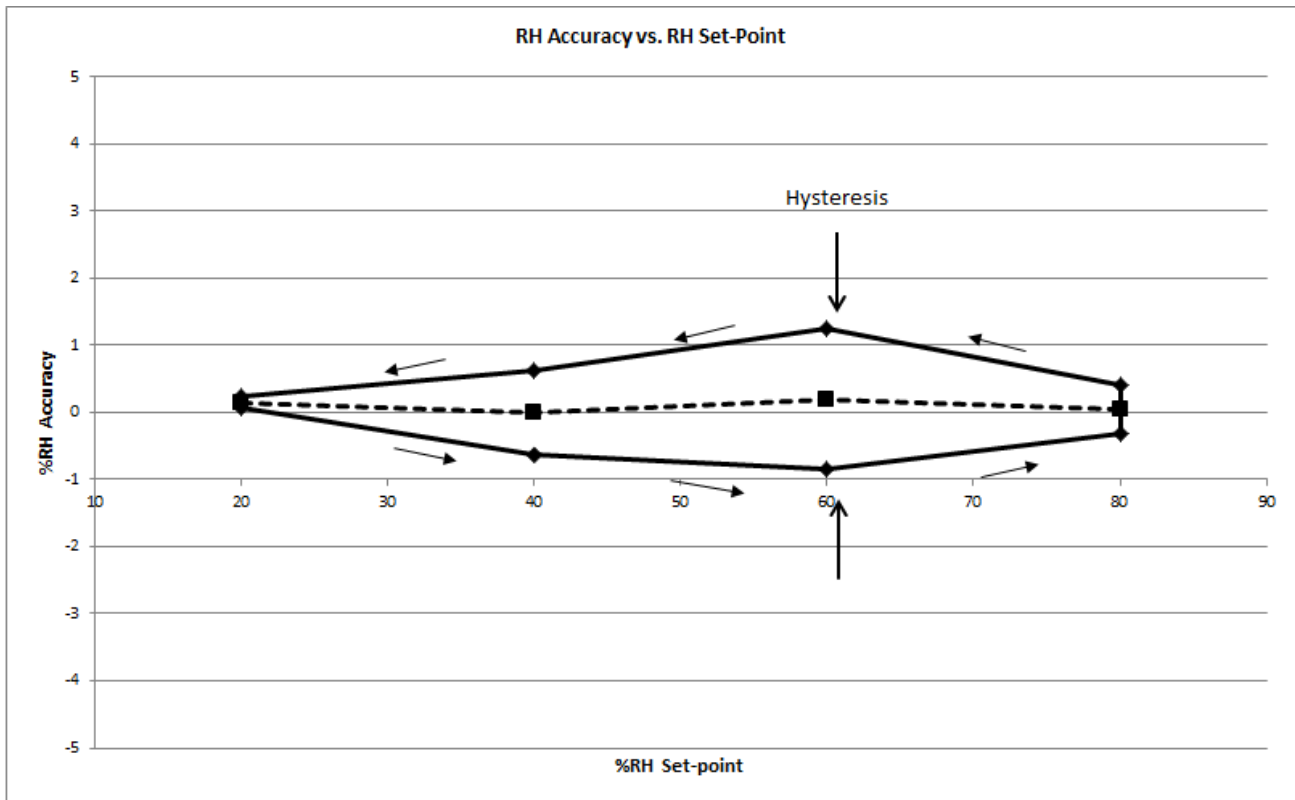

Figure 6. Measuring Sensor Accuracy Including Hysteresis

The RH accuracy is defined as the dotted line shown in Figure 6, which is the average of the two data points at each relative humidity set-point. In this case, the sensor shows an accuracy of 0.25%RH. The Si7020 accuracy specification (Table 4) includes:

- Unit-to-unit and lot-to-lot variation
- Accuracy of factory calibration
- Margin for shifts that can occur during solder reflow

The accuracy specification does not include:

- Hysteresis (typically $\pm 1\%$)
- Effects from long term exposure to very humid conditions
- Contamination of the sensor by particulates, chemicals, etc.
- Other aging related shifts ("Long-term stability")
- Variations due to temperature (see Drift vs. Temperature in Table 4). RH readings will typically vary with temperature by less than $\pm 0.05\% \text{ } ^\circ\text{C}$.

4.2. Hysteresis

The moisture absorbent film (polymeric dielectric) of the humidity sensor will carry a memory of its exposure history, particularly its recent or extreme exposure history. A sensor exposed to relatively low humidity will carry a negative offset relative to the factory calibration, and a sensor exposed to relatively high humidity will carry a positive offset relative to the factory calibration. This factor causes a hysteresis effect illustrated by the solid trace in Figure 6. The hysteresis value is the difference in %RH between the maximum absolute error on the decreasing humidity ramp and the maximum absolute error on the increasing humidity ramp at a single relative humidity setpoint and is expressed as a bipolar quantity relative to the average error (dashed trace). In the example of Figure 6, the measurement uncertainty due to the hysteresis effect is $\pm 1.0\%$ RH.

4.3. Prolonged Exposure to High Humidity

Prolonged exposure to high humidity will result in a gradual upward drift of the RH reading. The shift in sensor reading resulting from this drift will generally disappear slowly under normal ambient conditions. The amount of shift is proportional to the magnitude of relative humidity and the length of exposure. In the case of lengthy exposure to high humidity, some of the resulting shift may persist indefinitely under typical conditions. It is generally possible to substantially reverse this affect by baking the device (see section "4.6. Bake/Hydrate Procedure").

4.4. PCB Assembly

4.4.1. Soldering

Like most ICs, Si7020 devices are shipped from the factory vacuum-packed with an enclosed desiccant to avoid any RH accuracy drift during storage and to prevent any moisture-related issues during solder reflow. The following guidelines should be observed during PCB assembly:

- Si7020 devices are compatible with standard board assembly processes. Devices should be soldered using reflow per the recommended card reflow profile. See Section "10. PCB Land Pattern and Solder Mask Design" for the recommended card reflow profile.
- A "no clean" solder process is recommended to minimize the need for water or solvent rinses after soldering. Cleaning after soldering is possible, but must be done carefully to avoid impacting the performance of the sensor. See AN607 for more information on cleaning.
- It is essential that the exposed polymer sensing film be kept clean and undamaged. This can be accomplished by careful handling and a clean, well-controlled assembly process. When in doubt or for extra protection, a heat-resistant, protective cover such as Kapton™ KPPD-1/8 polyimide tape can be installed during PCB assembly.

Si7020s may be ordered with a factory-fitted, solder-resistant protective cover. This cover provides protection during PCB assembly or rework but without the time and effort required to install and remove the Kapton tape. It can be left in place for the lifetime of the product, preventing liquids, dust or other contaminants from coming into contact with the polymer sensor film. See Section "8. Ordering Guide" for a list of ordering part numbers that include the cover.

4.4.2. Rehydration

The measured humidity value will generally shift slightly after solder reflow. A portion of this shift is permanent and is accounted for in the accuracy specifications in Table 4. After soldering, an Si7020 should be allowed to equilibrate under controlled RH conditions (room temperature, 45–55%RH) for at least 48 hours to eliminate the remainder of the shift and return the device to its specified accuracy performance.

4.4.3. Rework

To maintain the specified sensor performance, care must be taken during rework to minimize the exposure of the device to excessive heat and to avoid damage/contamination or a shift in the sensor reading due to liquids, solder flux, etc. Manual touch-up using a soldering iron is permissible under the following guidelines:

- The exposed polymer sensing film must be kept clean and undamaged. A protective cover is recommended during any rework operation (Kapton® tape or the factory installed cover).
- Flux must not be allowed to contaminate the sensor; liquid flux is not recommended even with a cover in place. Conventional lead-free solder with rosin core is acceptable for touch-up as long as a cover is in place during the rework.
- If possible, avoid water or solvent rinses after touch-up. Cleaning after soldering is possible, but must be done carefully to avoid impacting the performance of the sensor. See AN607 for more information on cleaning.
- Minimize the heating of the device. Soldering iron temperatures should not exceed 350 °C and the contact time per pin should not exceed 5 seconds.
- Hot air rework is not recommended. If a device must be replaced, remove the device by hot air and solder a new part in its place by reflow following the guidelines above.

***Note:** All trademarks are the property of their respective owners.



Figure 7. Si7020 with Factory-Installed Protective Cover

4.5. Protecting the Sensor

Because the sensor operates on the principal of measuring a change in capacitance, any changes to the dielectric constant of the polymer film will be detected as a change in relative humidity. Therefore, it is important to minimize the probability of contaminants coming into contact with the sensor. Dust and other particles as well as liquids can affect the RH reading. It is recommended that a cover is employed in the end system that blocks contaminants but allows water vapor to pass through. Depending on the needs of the application, this can be as simple as plastic or metallic gauze for basic protection against particulates or something more sophisticated such as a hydrophobic membrane providing up to IP67 compliant protection.

The Si7020 may be ordered with a factory-fitted, solder-resistant cover that can be left in place for the lifetime of the product. It is very low-profile, hydrophobic, and oleophobic. See section “8. Ordering Guide ” for a list of ordering part numbers that include the cover. A dimensioned drawing of the IC with the cover is included in section “9. Package Outline ” . Other characteristics of the cover are listed in Table 9.

Table 9. Specifications of Protective Cover

Parameter	Value
Material	PTFE
Operating Temperature	–40 to 125 °C
Maximum Reflow Temperature	260 °C
IP Rating (per IEC 529)	IP67

4.6. Bake/Hydrate Procedure

After exposure to extremes of temperature and/or humidity for prolonged periods, the polymer sensor film can become either very dry or very wet, in each case the result is either high or low relative humidity readings. Under normal operating conditions, the induced error will diminish over time. From a very dry condition, such as after shipment and soldering, the error will diminish over a few days at typical controlled ambient conditions, e.g., 48 hours of $45 \leq \%RH \leq 55$. However, from a very wet condition, recovery may take significantly longer. To accelerate recovery from a wet condition, a bake and hydrate cycle can be implemented. This operation consists of the following steps:

- Baking the sensor at 125 °C for ≥ 12 hours
- Hydration at 30 °C in 75% RH for ≥ 10 hours

Following this cycle, the sensor will return to normal operation in typical ambient conditions after a few days.

4.7. Long Term Drift/Aging

Over long periods of time, the sensor readings may drift due to aging of the device. Standard accelerated life testing of the Si7020 has resulted in the specifications for long-term drift shown in Table 4 and Table 5. This contribution to the overall sensor accuracy accounts only for the long-term aging of the device in an otherwise benign operating environment and does not include the effects of damage, contamination, or exposure to extreme environmental conditions.

5. I²C Interface

The Si7020 communicates with the host controller over a digital I²C interface. The 7-bit base slave address is 0x40.

Table 10. I²C Slave Address Byte

A6	A5	A4	A3	A2	A1	A0	R/W
1	0	0	0	0	0	0	0

Master I²C devices communicate with the Si7020 using a command structure. The commands are listed in the I²C command table. Commands other than those documented below are undefined and should not be sent to the device.

Table 11. I²C Command Table

Command Description	Command Code
Measure Relative Humidity, Hold Master Mode	0xE5
Measure Relative Humidity, No Hold Master Mode	0xF5
Measure Temperature, Hold Master Mode	0xE3
Measure Temperature, No Hold Master Mode	0xF3
Read Temperature Value from Previous RH Measurement	0xE0
Reset	0xFE
Write RH/T User Register 1	0xE6
Read RH/T User Register 1	0xE7
Read Electronic ID 1st Byte	0xFA 0x0F
Read Electronic ID 2nd Byte	0xFC 0xC9
Read Firmware Revision	0x84 0xB8

5.1. Issuing a Measurement Command

The measurement commands instruct the Si7020 to perform one of two possible measurements; Relative Humidity or Temperature. The procedure to issue any one of these commands is identical. While the measurement is in progress, the option of either clock stretching (Hold Master Mode) or Not Acknowledging read requests (No Hold Master Mode) is available to indicate to the master that the measurement is in progress; the chosen command code determines which mode is used.

Optionally, a checksum byte can be returned from the slave for use in checking for transmission errors. The checksum byte will follow the least significant measurement byte if it is acknowledged by the master. The checksum byte is not returned if the master “not acknowledges” the least significant measurement byte. The checksum byte is calculated using a CRC generator polynomial of $x^8 + x^5 + x^4 + 1$, with an initialization of 0x00.

The checksum byte is optional after initiating an RH or temperature measurement with commands 0xE5, 0xF5, 0xE3, and 0xF3. The checksum byte is required for reading the electronic ID with commands 0xFA 0x0F and 0xFC 0xC9. For all other commands, the checksum byte is not supported.



Sequence to perform a measurement and read back result (Hold Master Mode)

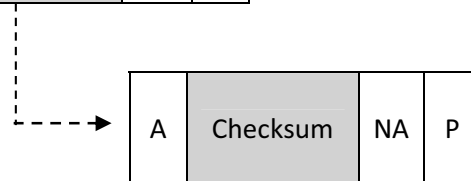
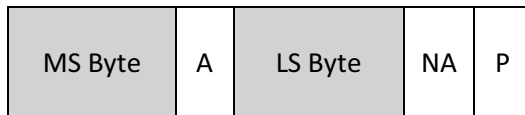
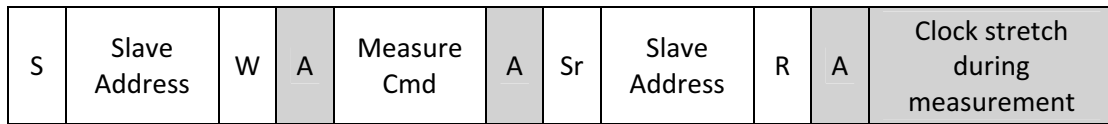

Sequence to perform a measurement and read back result (No Hold Master Mode)

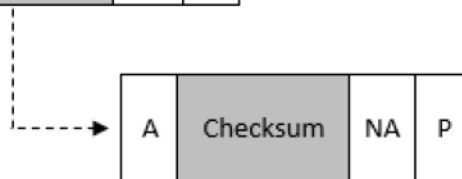
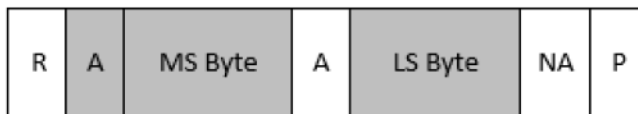
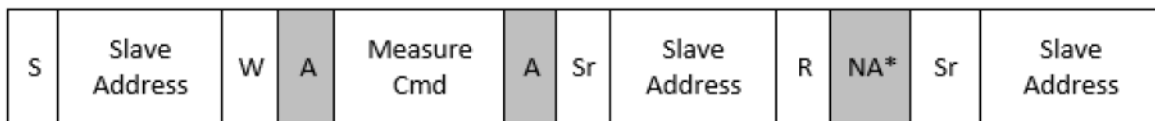

Note: Device will NACK the slave address byte until conversion is complete.

5.1.1. Measuring Relative Humidity

Once a relative humidity measurement has been made, the results of the measurement may be converted to percent relative humidity by using the following expression:

$$\%RH = \frac{125 * RH_Code}{65536} - 6$$

Where:

%RH is the measured relative humidity value in %RH

RH_Code is the 16-bit word returned by the Si7020

A humidity measurement will always return XXXXXX10 in the LSB field.

Due to normal variations in RH accuracy of the device as described in Table 4, it is possible for the measured value of %RH to be slightly less than 0 when the actual RH level is close to or equal to 0. Similarly, the measured value of %RH may be slightly greater than 100 when the actual RH level is close to or equal to 100. This is expected behavior, and it is acceptable to limit the range of RH results to 0 to 100%RH in the host software by truncating values that are slightly outside of this range.

5.1.2. Measuring Temperature

Each time a relative humidity measurement is made a temperature measurement is also made for the purposes of temperature compensation of the relative humidity measurement. If the temperature value is required, it can be read using command 0xE0; this avoids having to perform a second temperature measurement. The measure temperature commands 0xE3 and 0xF3 will perform a temperature measurement and return the measurement value, command 0xE0 does not perform a measurement but returns the temperature value measured during the relative humidity measurement.

The checksum output is not available with the 0xE0 command.

Sequence to read temperature value from previous RH measurement

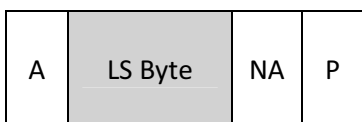
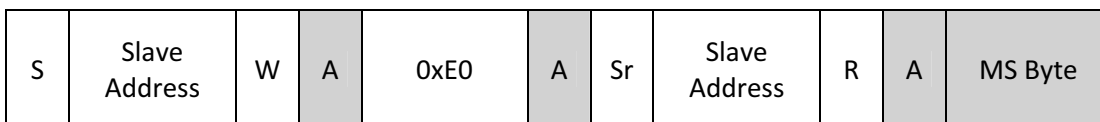

The results of the temperature measurement may be converted to temperature in degrees Celsius (°C) using the following expression:

$$\text{Temperature (}^{\circ}\text{C)} = \frac{175.72 * \text{Temp_Code}}{65536} - 46.85$$

Where:

Temperature (°C) is the measured temperature value in °C

Temp_Code is the 16-bit word returned by the Si7020

A temperature measurement will always return XXXXXX00 in the LSB field.

Si7020-A10

5.2. Reading and Writing User Registers

There is one user register on the Si7020 that allows the user to set the configuration of the Si7020. The procedure for accessing that register is described below.

The checksum byte is not supported after reading a user register.

Sequence to read a register

S	Slave Address	W	A	Read Reg Cmd	A	Sr	Slave Address	R	A	Read Data	NA	P
---	---------------	---	---	--------------	---	----	---------------	---	---	-----------	----	---

Sequence to write a register

S	Slave Address	W	A	Write Reg Cmd	A	Write Data	A	P
---	---------------	---	---	---------------	---	------------	---	---

5.3. Electronic Serial Number

The Si7020 provides a serial number individualized for each device that can be read via the I²C serial interface.

Two I²C commands are required to access the device memory and retrieve the complete serial number. The command sequence, and format of the serial number response is described in the figure below:



First access:

S	Slave Address	W	ACK	0xFA	ACK	0X0F	ACK			
S	Slave Address	R	ACK							
	SNA_3	ACK	CRC	ACK	SNA_2	ACK	CRC	ACK		
	SNA_1	ACK	CRC	ACK	SNA_0	ACK	CRC	NACK	P	

2nd access:

S	Slave Address	W	ACK	0xFC	ACK	0XC9	ACK			
S	Slave Address	R	ACK							
	SNB_3	ACK	SNB_2	ACK	CRC	ACK				
	SNB_1	ACK	SNB_0	ACK	CRC	NACK	P			

The format of the complete serial number is 64-bits in length, divided into 8 data bytes. The complete serial number sequence is shown below:

SNA_3	SNA_2	SNA_1	SNA_0	SNB_3	SNB_2	SNB_1	SNB_0
-------	-------	-------	-------	-------	-------	-------	-------

The SNB3 field contains the device identification to distinguish between the different Silicon Labs relative humidity and temperature devices. The value of this field maps to the following devices according to this table:

0x00 or 0xFF engineering samples

0x0D=13=Si7013

0x14=20=Si7020

0x15=21=Si7021

5.4. Firmware Revision

The internal firmware revision can be read with the following I²C transaction:

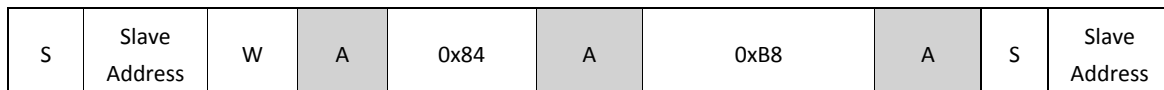

The values in this field are encoded as follows:

0xFF=Firmware version 1.0

5.5. Heater

The Si7020 contains an integrated resistive heating element that may be used to raise the temperature of the sensor. This element can be used to test the sensor, to drive off condensation, or to implement dew-point measurement when the Si7020 is used in conjunction with a separate temperature sensor such as another Si7020 (the heater will raise the temperature of the internal temperature sensor).

The heater can be activated using HTRE, bit 2 in User Register 1. Turning on the heater will reduce the tendency of the humidity sensor to accumulate an offset due to "memory" of sustained high humidity conditions.

6. Control Register

Table 12. Register Summary

Register	Bit 7	Bit 6	Bit 5	Bit 4	Bit 3	Bit 2	Bit 1	Bit 0
User Register 1	RES1	VDDS	RSVD	RSVD	RSVD	HTRE	RSVD	RES0

Notes:

- Any register not listed here is reserved and must not be written. The result of a read operation on these bits is undefined.
- Except where noted, reserved register bits will always read back as “1,” and are not affected by write operations. For future compatibility, it is recommended that prior to a write operation, registers should be read. Then the values read from the RSVD bits should be written back unchanged during the write operation.

6.1. Register Descriptions

Register 1. User Register 1

Bit	D7	D6	D5	D4	D3	D2	D1	D0
Name	RES1	VDDS	RSVD	RSVD	RSVD	HTRE	RSVD	RES0
Type	R/W	R	R/W	R/W		R/W	R/W	R/W

Reset Settings = 0011_1010

Bit	Name	Function
D7; D0	RES[1:0]	Measurement Resolution: RH Temp 00: 12 bit14 bit 01: 8 bit12 bit 10: 10 bit13 bit 11: 11 bit11 bit
D6	VDDS	VDD Status: 0: V _{DD} OK 1: V _{DD} Low The minimum recommended operating voltage is 1.9 V. A transition of the VDD status bit from 0 to 1 indicates that VDD is between 1.8 V and 1.9 V. If the VDD drops below 1.8 V, the device will no longer operate correctly.
D5, D4, D3	RSVD	Reserved
D2	HTRE	1=On-chip Heater Enable 0=On-chip Heater Disable
D1	RSVD	Reserved

7. Pin Descriptions: Si7020 (Top View)

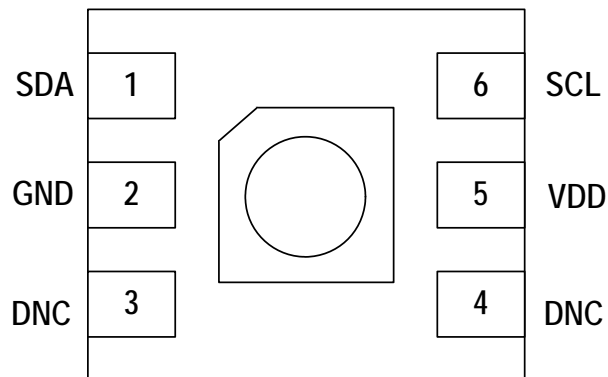

Pin Name	Pin #	Pin Description
SDA	1	I ² C data
GND	2	Ground. This pin is connected to ground on the circuit board through a trace. Do not connect directly to GND plane.
VDD	5	Power. This pin is connected to power on the circuit board.
SCL	6	I ² C clock
DNC	3,4	These pins should be soldered to pads on the PCB for mechanical stability; they can be electrically floating or tied to VDD (do not tie to GND).
T _{GND}	Paddle	This pad is connected to GND internally. This pad is the main thermal input to the on-chip temperature sensor. The paddle should be soldered to a floating pad.

8. Ordering Guide

Table 13. Device Ordering Guide

P/N	Description	Max. Accuracy		Pkg	Operating Range (°C)	Protective Cover	Packing Format
		Temp	RH				
Si7020-A10-GM	Digital temperature/ humidity sensor	±0.4 °C	± 4%	DFN 6	-40 to +85 °C	N	Tube
Si7020-A10-GMR	Digital temperature/ humidity sensor	±0.4 °C	± 4%	DFN 6	-40 to +85 °C	N	Tape & Reel
Si7020-A10-GM1	Digital temperature/ humidity sensor	±0.4 °C	± 4%	DFN 6	-40 to +85 °C	Y	Cut Tape
Si7020-A10-GM1R	Digital temperature/ humidity sensor	±0.4 °C	± 4%	DFN 6	-40 to +85 °C	Y	Tape & Reel
Si7020-A10-IM	Digital temperature/ humidity sensor – industrial temp range	±0.4 °C	± 4%	DFN 6	-40 to +125 °C	N	Tube
Si7020-A10-IMR	Digital temperature/ humidity sensor – industrial temp range	±0.4 °C	± 4%	DFN 6	-40 to +125 °C	N	Tape & Reel
Si7020-A10-IM1	Digital temperature/ humidity sensor – industrial temp range	±0.4 °C	± 4%	DFN 6	-40 to +125 °C	Y	Cut Tape
Si7020-A10-IM1R	Digital temperature/ humidity sensor – industrial temp range	±0.4 °C	± 4%	DFN 6	-40 to +125 °C	Y	Tape & Reel
Si7020-A10-YM0	Digital temperature/ humidity sensor – automotive	±0.4 °C	± 4%	DFN 6	-40 to +125 °C	N	Tube
Si7020-A10-YM0R	Digital temperature/ humidity sensor – automotive	±0.4 °C	± 4%	DFN 6	-40 to +125 °C	N	Tape & Reel
Si7020-A10-YM1	Digital temperature/ humidity sensor – automotive	±0.4 °C	± 4%	DFN 6	-40 to +125 °C	Y	Cut Tape
Si7020-A10-YM1R	Digital temperature/ humidity sensor – automotive	±0.4 °C	± 4%	DFN 6	-40 to +125 °C	Y	Tape & Reel

Note: The “A” denotes product revision A and “10” denotes firmware version 1.0.

9. Package Outline

9.1. Package Outline: 3x3 6-pin DFN

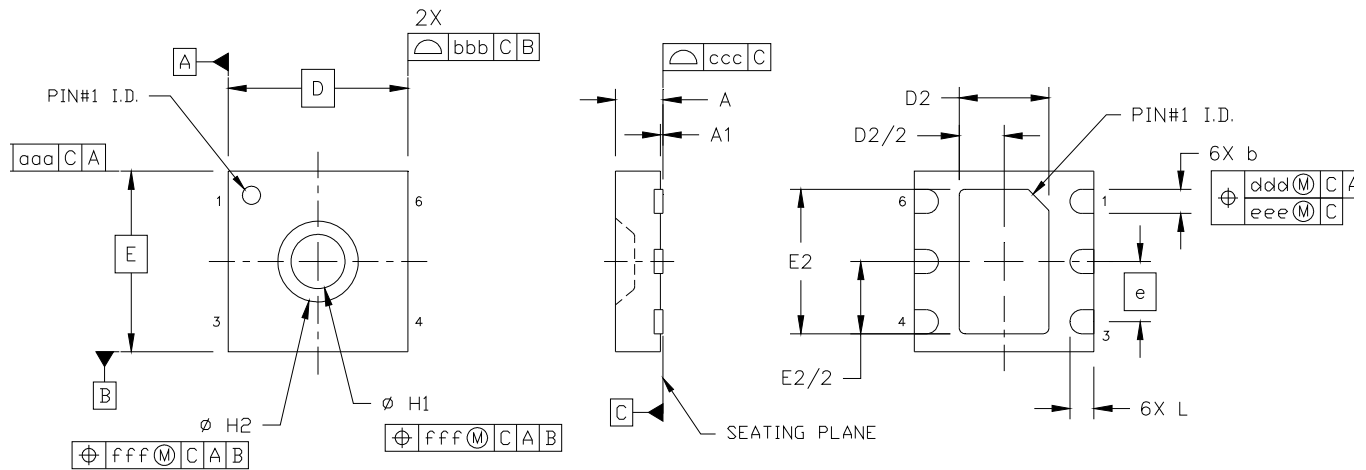

Figure 10. 3x3 6-pin DFN

Table 14. 3x3 6-pin DFN Package Diagram Dimensions

Dimension	Min	Nom	Max
A	0.70	0.75	0.80
A1	0.00	0.02	0.05
b	0.35	0.40	0.45
D	3.00 BSC.		
D2	1.40	1.50	1.60
e	1.00 BSC.		
E	3.00 BSC.		
E2	2.30	2.40	2.50
H1	0.85	0.90	0.95
H2	1.39	1.44	1.49
L	0.35	0.40	0.45
aaa	0.10		
bbb	0.10		
ccc	0.05		
ddd	0.10		
eee	0.05		
fff	0.05		
Notes:			
1. All dimensions shown are in millimeters (mm).			
2. Dimensioning and Tolerancing per ANSI Y14.5M-1994.			

Si7020-A10

9.2. Package Outline: 3x3 6-pin DFN with Protective Cover

Figure 8 illustrates the package details for the Si7020 with the optional protective cover. The table below lists the values for the dimensions shown in the illustration.

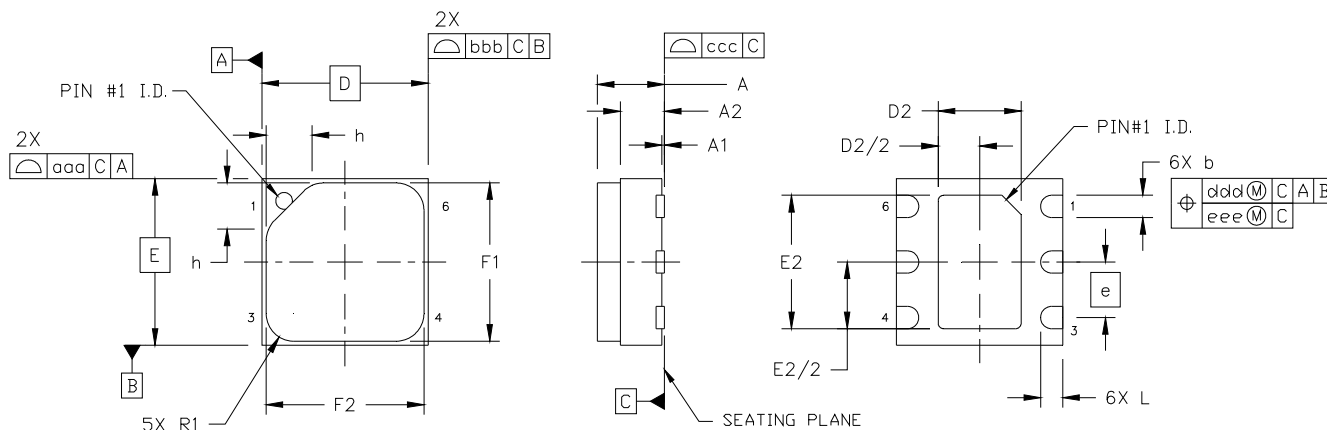

Figure 8. 3x3 6-pin DFN with Protective Cover

Table 15. 3x3 6-pin DFN with Protective Cover Package Diagram Dimensions

Dimension	Min	Nom	Max
A	—	—	1.21
A1	0.00	0.02	0.05
A2	0.70	0.75	0.80
b	0.35	0.40	0.45
D	3.00 BSC.		
D2	1.40	1.50	1.60
e	1.00 BSC.		
E	3.00 BSC.		
E2	2.30	2.40	2.50
F1	2.70	2.80	2.90
F2	2.70	2.80	2.90
h	0.76	0.83	0.90
L	0.35	0.40	0.45
R1	0.45	0.50	0.55
aaa	0.10		
bbb	0.10		
ccc	0.05		
ddd	0.10		
eee	0.05		
Notes:			
1. All dimensions are shown in millimeters (mm).			
2. Dimensioning and Tolerancing per ANSI Y14.5M-1994.			

10. PCB Land Pattern and Solder Mask Design

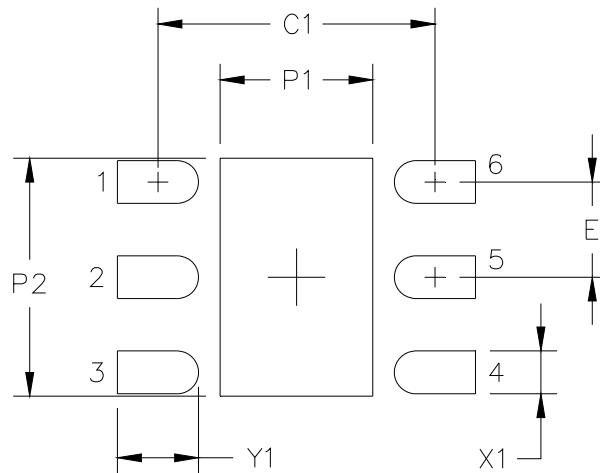

Figure 9. Si7020 PCB Land Pattern

Table 16. PCB Land Pattern Dimensions

Symbol	mm
C1	2.90
E	1.00
P1	1.60
P2	2.50
X1	0.45
Y1	0.85

Notes:

General

1. All dimensions shown are at Maximum Material Condition (MMC). Least Material Condition (LMC) is calculated based on a Fabrication Allowance of 0.05 mm.
2. This Land Pattern Design is based on the IPC-7351 guidelines.

Solder Mask Design

3. All metal pads are to be non-solder mask defined (NSMD). Clearance between the solder mask and the metal pad is to be 60 μm minimum, all the way around the pad.

Stencil Design

4. A stainless steel, laser-cut and electro-polished stencil with trapezoidal walls should be used to assure good solder paste release.
5. The stencil thickness should be 0.125 mm (5 mils).
6. The ratio of stencil aperture to land pad size should be 1:1 for all perimeter pins.
7. A 2x1 array of 1.00 mm square openings on 1.30 mm pitch should be used for the center ground pad to achieve a target solder coverage of 50%.

Card Assembly

8. A No-Clean, Type-3 solder paste is recommended.
9. The recommended card reflow profile is per the JEDEC/IPC J-STD-020 specification for Small Body Components.

Si7020-A10

11. Top Marking

11.1. Si7020 Top Marking

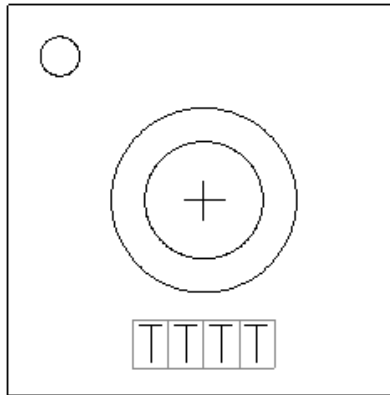

11.2. Top Marking Explanation

Mark Method:	Laser
Font Size	0.30 mm
Pin 1 Indicator:	Circle = 0.30 mm Diameter Upper-Left Corner
Line 1 Marking:	TTTT = Mfg Code

12. Additional Reference Resources

- AN607: Si70xx Humidity Sensor Designer's Guide

DOCUMENT CHANGE LIST

Revision 0.1 to Revision 0.9

- Updates to Section 1. Electrical Specifications.
- Updated Table 2. General Specifications.
- Update Figure 1. I2C Interface Timing Diagram.
- Updated Section 2. Typical Applications Circuits.
- Updated Table 6. Thermal Characteristics.
- Updated Table 12. I2C Command Table.
- Updated Section 4.4 PCB Assembly.
- Updated Section 5.3. Measuring Relative Humidity.
- Updated Section 5.4. Measuring Temperature.
- Updated Section 5.5. Electronic Serial Number.
- Updated Section 9.1. Package Outline.
- Updated Section 11. Top Marking.

Revision 0.9 to Revision 0.95

- Updated the Features on page 1 Updated block diagram
- Added -I part numbers
- Updated Table 1
- Updated Table 2
- Updated Table 3
- Updated Table 4
- Updated Table 5
- Updated Figure 4
- Updated Section 4.4.1.
- Updated Table 12
- Updated Section 5
- Corrected a typo on Section 6.1, Register 1.
- Updated firmware version to -A10 in Section 8

Revision 0.95 to Revision 1.0

- Updated Table 2.
- Clarified footnotes in Table 4.
- Update Table 7.
- Updated part numbers in Table 8.
- Updated Section 5.1.
- Updated Section 5.1.2.
- Updated Section 5.4.
- Updated footnotes in Table 12.
- Updated description for Register 1, bit D6.
- Updated automotive part numbers in Table 13.
- Added firmware description to Table 13.

Revision 1.0 to Revision 1.1

- Updated Note 2 in Table 3.
- Updated Section 4.5.
- Updated Table 9.
- Corrected a typo in the I2C sequence for no-hold mode in Section 5.1.
- Updated Table 15, dimensions F1 and F2.

CONTACT INFORMATION

Silicon Laboratories Inc.

400 West Cesar Chavez
Austin, TX 78701
Tel: 1+(512) 416-8500
Fax: 1+(512) 416-9669
Toll Free: 1+(877) 444-3032

Please visit the Silicon Labs Technical Support web page:
<http://www.siliconlabs.com/support/pages/contacttechnicalsupport.aspx>
and register to submit a technical support request.

Patent Notice

Silicon Labs invests in research and development to help our customers differentiate in the market with innovative low-power, small size, analog-intensive mixed-signal solutions. Silicon Labs' extensive patent portfolio is a testament to our unique approach and world-class engineering team.

The information in this document is believed to be accurate in all respects at the time of publication but is subject to change without notice. Silicon Laboratories assumes no responsibility for errors and omissions, and disclaims responsibility for any consequences resulting from the use of information included herein. Additionally, Silicon Laboratories assumes no responsibility for the functioning of undescribed features or parameters. Silicon Laboratories reserves the right to make changes without further notice. Silicon Laboratories makes no warranty, representation or guarantee regarding the suitability of its products for any particular purpose, nor does Silicon Laboratories assume any liability arising out of the application or use of any product or circuit, and specifically disclaims any and all liability, including without limitation consequential or incidental damages. Silicon Laboratories products are not designed, intended, or authorized for use in applications intended to support or sustain life, or for any other application in which the failure of the Silicon Laboratories product could create a situation where personal injury or death may occur. Should Buyer purchase or use Silicon Laboratories products for any such unintended or unauthorized application, Buyer shall indemnify and hold Silicon Laboratories harmless against all claims and damages.

Silicon Laboratories and Silicon Labs are trademarks of Silicon Laboratories Inc.
Other products or brandnames mentioned herein are trademarks or registered trademarks of their respective holders.

Looking for pricing, stock, or lifecycle information?

Click below to explore more details on WIN SOURCE:

 [View SI7020-A10-GM1R on WIN SOURCE](#)

 [Silicon Labs](#) Information

Optimize Your Supply Chain with WIN SOURCE Solutions

-  Global Sourcing Solution
-  Obsolete Management
-  Cost Control Management
-  Shortage Management
-  Alternative Solution
-  Excess Inventory Management