



**THE DATASHEET OF
74ALVCH162373TX**



74ALVCH162373

Low Voltage 16-Bit Transparent Latch with Bushold and 26Ω Series Resistors in Outputs

General Description

The ALVCH162373 contains sixteen non-inverting latches with 3-STATE outputs and is intended for bus oriented applications. The device is byte controlled. The flip-flops appear to be transparent to the data when the Latch enable (LE) is HIGH. When LE is LOW, the data that meets the setup time is latched. Data appears on the bus when the Output Enable (OE) is LOW. When OE is HIGH, the outputs are in a high impedance state.

The ALVCH162373 data inputs include active bushold circuitry, eliminating the need for external pull-up resistors to hold unused or floating data inputs at a valid logic level.

The ALVCH162373 is also designed with 26Ω series resistors in the outputs. This design reduces line noise in applications such as memory address driver, clock drivers and bus transceivers/transmitters.

The 74ALVCH162373 is designed for low voltage (1.65V to 3.6V) V_{CC} applications with output compatibility up to 3.6V.

The 74ALVCH162373 is fabricated with an advanced CMOS technology to achieve high speed operation while maintaining low CMOS power dissipation.

Features

- 1.65V to 3.6V V_{CC} supply operation
- 3.6V tolerant control inputs and outputs
- Bushold on data inputs eliminates the need for external pull-up/pull-down resistors
- 26Ω series resistors in outputs
- t_{PD} (I_n to O_n)
 - 3.8 ns max for 3.0V to 3.6V V_{CC}
 - 5.0 ns max for 2.3V to 2.7V V_{CC}
 - 9.0 ns max for 1.65V to 1.95V V_{CC}
- Uses patented noise/EMI reduction circuitry
- Latchup conforms to JEDEC JED78
- ESD performance:
 - Human body model > 2000V
 - Machine model > 200V

Ordering Code:

Ordering Number	Package Number	Package Description
74ALVCH162373T	MTD48	48-Lead Thin Shrink Small Outline Package (TSSOP), JEDEC MO-153, 6.1mm Wide

Devices also available in Tape and Reel. Specify by appending the suffix letter "X" to the ordering code.

Logic Symbol

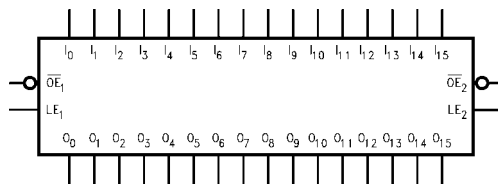

Pin Descriptions

Pin Names	Description
\overline{OE}_n	Output Enable Input (Active LOW)
LE_n	Latch Enable Input
I_0-I_{15}	Bushold Inputs
O_0-O_{15}	Outputs

Connection Diagram

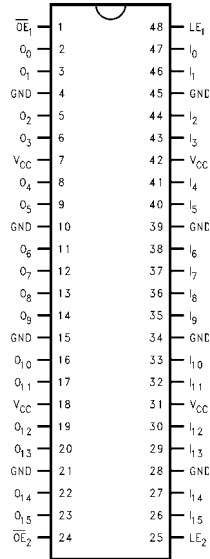

Truth Tables

Inputs			Outputs
LE ₁	\overline{OE}_1	I ₀ -I ₇	O ₀ -O ₇
X	H	X	Z
H	L	L	L
H	L	H	H
L	L	X	O ₀

Inputs			Outputs
LE ₂	\overline{OE}_2	I ₈ -I ₁₅	O ₈ -O ₁₅
X	H	X	Z
H	L	L	L
H	L	H	H
L	L	X	O ₀

H = HIGH Voltage Level
 L = LOW Voltage Level
 X = Immaterial (HIGH or LOW, control inputs may not float)
 Z = High Impedance
 O₀ = Previous O₀ before HIGH-to-LOW of Latch Enable

Functional Description

The 74ALVCH162373 contains sixteen edge D-type latches with 3-STATE outputs. The device is byte controlled with each byte functioning identically, but independent of the other. Control pins can be shorted together to obtain full 16-bit operation. The following description applies to each byte. When the Latch Enable (LE_n) input is HIGH, data on the I_n enters the latches. In this condition the latches are transparent, i.e., a latch output will change state each time

its I input changes. When LE_n is LOW, the latches store information that was present on the I inputs a setup time preceding the HIGH-to-LOW transition on LE_n. The 3-STATE outputs are controlled by the Output Enable (\overline{OE}_n) input. When \overline{OE}_n is LOW the standard outputs are in the 2-state mode. When \overline{OE}_n is HIGH, the standard outputs are in the high impedance mode but this does not interfere with entering new data into the latches.

Logic Diagram

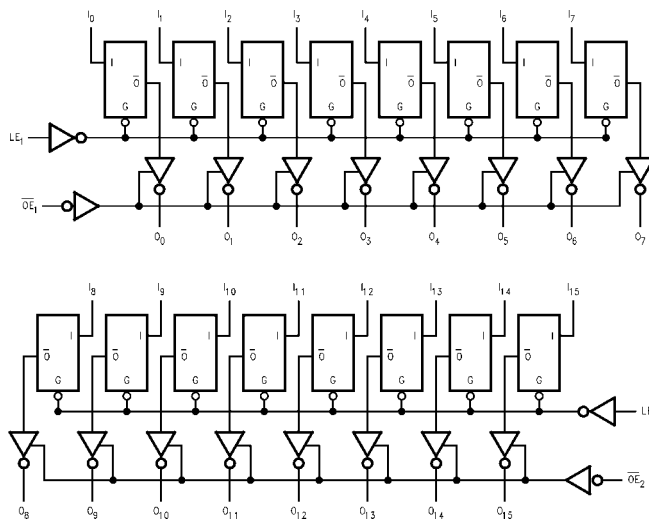

Please note that this diagram is provided only for the understanding of logic operations and should not be used to estimate propagation delays.

Absolute Maximum Ratings(Note 1)

Supply Voltage (V_{CC})	-0.5V to +4.6V
DC Input Voltage (V_I)	-0.5V to 4.6V
Output Voltage (V_O) (Note 2)	-0.5V to $V_{CC} + 0.5V$
DC Input Diode Current (I_{IK})	
$V_I < 0V$	-50 mA
DC Output Diode Current (I_{OK})	
$V_O < 0V$	-50 mA
DC Output Source/Sink Current (I_{OH}/I_{OL})	± 50 mA
DC V_{CC} or GND Current per Supply Pin (I_{CC} or GND)	± 100 mA
Storage Temperature Range (T_{STG})	-65°C to +150°C

Recommended Operating Conditions (Note 3)

Power Supply	
Operating	1.65V to 3.6V
Input Voltage (V_I)	0V to V_{CC}
Output Voltage (V_O)	0V to V_{CC}
Free Air Operating Temperature (T_A)	-40°C to +85°C
Minimum Input Edge Rate ($\Delta t/\Delta V$)	
$V_{IN} = 0.8V$ to 2.0V, $V_{CC} = 3.0V$	10 ns/V

Note 1: The Absolute Maximum Ratings are those values beyond which the safety of the device cannot be guaranteed. The device should not be operated at these limits. The parametric values defined in the Electrical Characteristics tables are not guaranteed at the Absolute Maximum Ratings. The "Recommended Operating Conditions" table will define the conditions for actual device operation.

Note 2: I_O Absolute Maximum Rating must be observed, limited to 4.6V.

Note 3: Floating or unused control inputs must be held HIGH or LOW.

DC Electrical Characteristics

Symbol	Parameter	Conditions	V_{CC} (V)	Min	Max	Units
V_{IH}	HIGH Level Input Voltage		1.65 - 1.95 2.3 - 2.7 2.7 - 3.6	$0.65 \times V_{CC}$ 1.7 2.0		V
V_{IL}	LOW Level Input Voltage		1.65 - 1.95 2.3 - 2.7 2.7 - 3.6		$0.35 \times V_{CC}$ 0.7 0.8	V
V_{OH}	HIGH Level Output Voltage	$I_{OH} = -100 \mu A$	1.65 - 3.6	$V_{CC} - 0.2$		V
		$I_{OH} = -2$ mA	1.65	1.2		
		$I_{OH} = -4$ mA	2.3	1.9		
		$I_{OH} = -6$ mA	2.3	1.7		
		$I_{OH} = -8$ mA	3.0	2.4		
		$I_{OH} = -12$ mA	2.7	2		
V_{OL}	LOW Level Output Voltage	$I_{OL} = 100 \mu A$	1.65 - 3.6		0.2	V
		$I_{OL} = 2$ mA	1.65		0.45	
		$I_{OL} = 4$ mA	2.3		0.4	
		$I_{OL} = 6$ mA	2.3		0.55	
		$I_{OL} = 8$ mA	3.0		0.55	
		$I_{OL} = 12$ mA	2.7		0.6	
I_I	Input Leakage Current	$0 \leq V_I \leq 3.6V$	3.6		± 5.0	μA
$I_{I(HOLD)}$	Bushold Input Minimum Drive Hold Current	$V_{IN} = 0.58V$	1.65	25		μA
		$V_{IN} = 1.07V$	1.65	-25		
		$V_{IN} = 0.7V$	2.3	45		
		$V_{IN} = 1.7V$	2.3	-45		
		$V_{IN} = 0.8V$	3.0	75		
		$V_{IN} = 2.0V$	3.0	-75		
$0 < V_O \leq 3.6V$	3.6		± 500			
I_{OZ}	3-STATE Output Leakage	$0 \leq V_O \leq 3.6V$	3.6		± 10	μA
I_{CC}	Quiescent Supply Current	$V_I = V_{CC}$ or GND, $I_O = 0$	3.6		40	μA
ΔI_{CC}	Increase in I_{CC} per Input	$V_{IH} = V_{CC} - 0.6V$	3 - 3.6		750	μA

AC Electrical Characteristics

Symbol	Parameter	$T_A = -40^\circ\text{C to } +85^\circ\text{C}, R_L = 500\Omega$								Units
		$C_L = 50\text{ pF}$				$C_L = 30\text{ pF}$				
		$V_{CC} = 3.3V \pm 0.3V$		$V_{CC} = 2.7V$		$V_{CC} = 2.5V \pm 0.2V$		$V_{CC} = 1.8V \pm 0.15V$		
		Min	Max	Min	Max	Min	Max	Min	Max	
t_{PHL}, t_{PLH}	Propagation Delay Bus to Bus	1.3	3.8	1.5	5.0	1.0	4.5	1.5	9.0	ns
t_{PHL}, t_{PLH}	Propagation Delay LE to Bus	1.3	4.1	1.5	5.4	1.0	4.9	1.5	9.8	ns
t_{PZL}, t_{PZH}	Output Enable Time	1.3	4.4	1.5	5.9	1.0	5.4	1.5	9.8	ns
t_{PLZ}, t_{PHZ}	Output Disable Time	1.3	4.5	1.5	4.9	1.0	4.4	1.5	7.9	ns
t_W	Pulse Width	1.5		1.5		1.5		4.0		ns
t_S	Setup Time	1.5		1.5		1.5		2.5		ns
t_H	Hold Time	1.0		1.0		1.0		1.0		ns

Capacitance

Symbol	Parameter	Conditions	$T_A = +25^\circ\text{C}$		Units
			V_{CC}	Typical	
C_{IN}	Input Capacitance	$V_I = 0V \text{ or } V_{CC}$	3.3	6	pF
C_{OUT}	Output Capacitance	$V_I = 0V \text{ or } V_{CC}$	3.3	7	pF
C_{PD}	Power Dissipation Capacitance	Outputs Enabled $f = 10\text{ MHz}, C_L = 50\text{ pF}$	3.3	20	pF
			2.5	20	

AC Loading and Waveforms

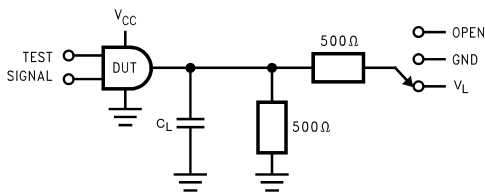

FIGURE 1. AC Test Circuit

TABLE 1. Values for Figure 1

TEST	SWITCH
t_{PLH} , t_{PHL}	Open
t_{PZL} , t_{PLZ}	V_L
t_{PZH} , t_{PHZ}	GND

TABLE 2. Variable Matrix
(Input Characteristics: $f = 1\text{MHz}$; $t_r = t_f = 2\text{ns}$; $Z_0 = 50\Omega$)

Symbol	V_{CC}					
	$3.3\text{V} \pm 0.3\text{V}$	2.7V	$2.5\text{V} \pm 0.2\text{V}$	$1.8\text{V} \pm 0.15\text{V}$		
V_{mi}	1.5V	1.5V	$V_{CC}/2$	$V_{CC}/2$		
V_{mo}	1.5V	1.5V	$V_{CC}/2$	$V_{CC}/2$		
V_X	$V_{OL} + 0.3\text{V}$	$V_{OL} + 0.3\text{V}$	$V_{OL} + 0.15\text{V}$	$V_{OL} + 0.15\text{V}$		
V_Y	$V_{OH} - 0.3\text{V}$ </tr <tr> <td>V_L</td> <td>6V</td> <td>6V</td> <td>$V_{CC} * 2$</td> <td>$V_{CC} * 2$</td> </tr>	V_L	6V	6V	$V_{CC} * 2$	$V_{CC} * 2$
V_L	6V	6V	$V_{CC} * 2$	$V_{CC} * 2$		

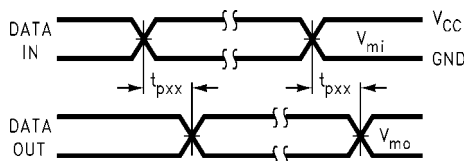

FIGURE 2. Waveform for Inverting and Non-Inverting Functions

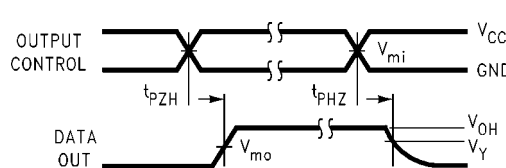

FIGURE 3. 3-STATE Output HIGH Enable and Disable Times for Low Voltage Logic

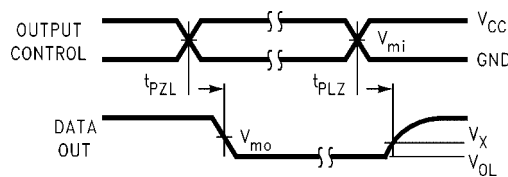

FIGURE 4. 3-STATE Output LOW Enable and Disable Times for Low Voltage Logic

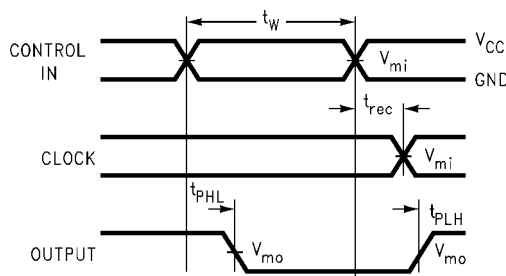

FIGURE 5. Propagation Delay, Pulse Width and t_{REC} Waveforms

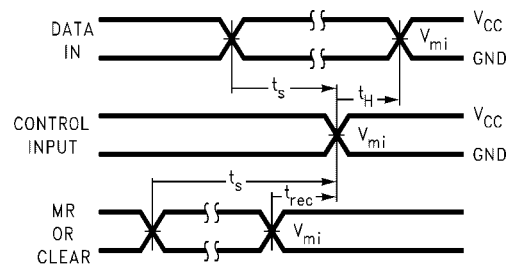
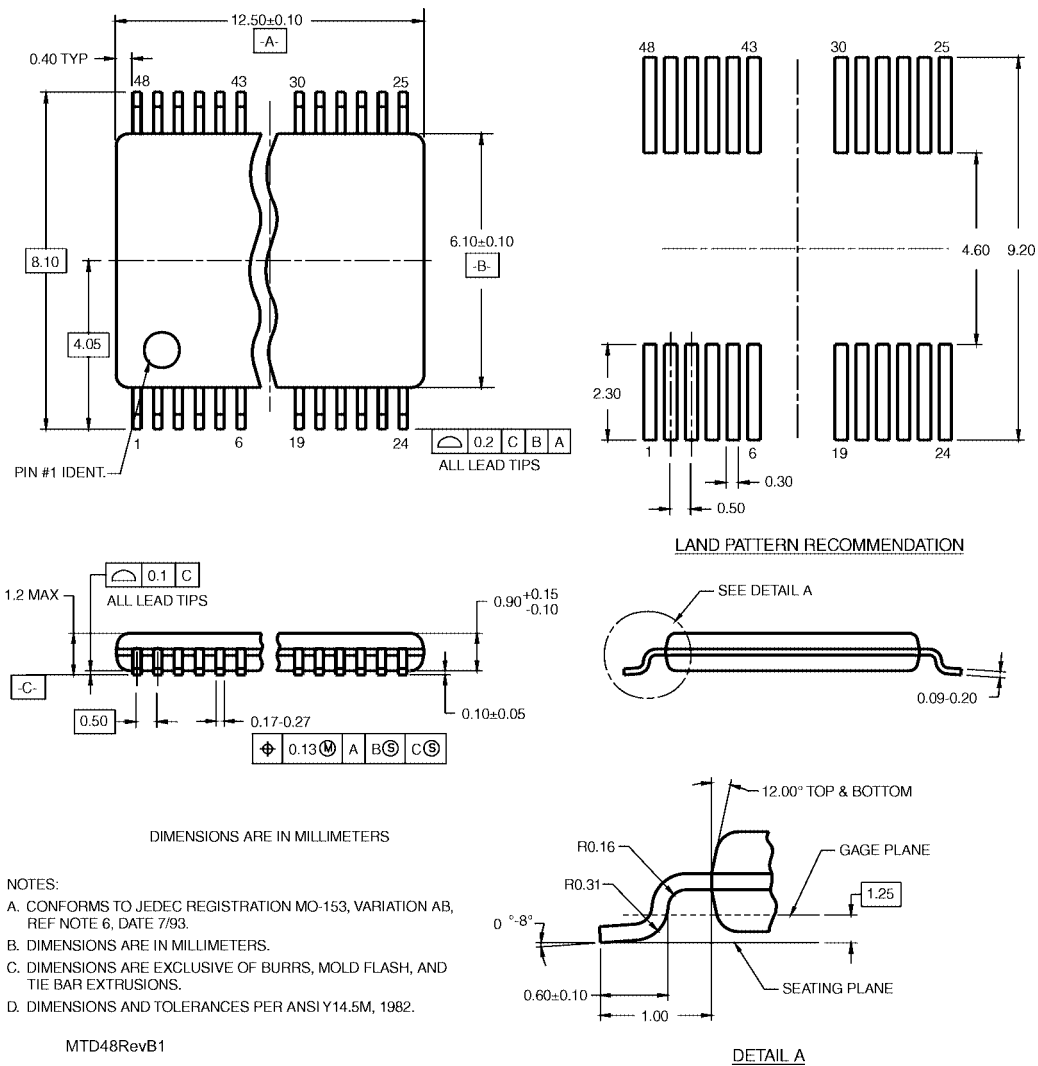

FIGURE 6. Setup Time, Hold Time and Recovery Time for Low Voltage Logic

Physical Dimensions inches (millimeters) unless otherwise noted



48-Lead Thin Shrink Small Outline Package (TSSOP), JEDEC MO-153, 6.1mm Wide Package Number MTD48

Fairchild does not assume any responsibility for use of any circuitry described, no circuit patent licenses are implied and Fairchild reserves the right at any time without notice to change said circuitry and specifications.

LIFE SUPPORT POLICY

FAIRCHILD'S PRODUCTS ARE NOT AUTHORIZED FOR USE AS CRITICAL COMPONENTS IN LIFE SUPPORT DEVICES OR SYSTEMS WITHOUT THE EXPRESS WRITTEN APPROVAL OF THE PRESIDENT OF FAIRCHILD SEMICONDUCTOR CORPORATION. As used herein:

1. Life support devices or systems are devices or systems which, (a) are intended for surgical implant into the body, or (b) support or sustain life, and (c) whose failure to perform when properly used in accordance with instructions for use provided in the labeling, can be reasonably expected to result in a significant injury to the user.
2. A critical component in any component of a life support device or system whose failure to perform can be reasonably expected to cause the failure of the life support device or system, or to affect its safety or effectiveness.

www.fairchildsemi.com

Looking for pricing, stock, or lifecycle information?

Click below to explore more details on WIN SOURCE:

⊖ [View 74ALVCH162373TX on WIN SOURCE](#)

⊖ [Fairchild/ON Semiconductor](#) Information

Optimize Your Supply Chain with WIN SOURCE Solutions

- ✓ Global Sourcing Solution
- ✓ Obsolete Management
- ✓ Cost Control Management
- ✓ Shortage Management
- ✓ Alternative Solution
- ✓ Excess Inventory Management