



THE DATASHEET OF SGD02N120BUMA1



Fast IGBT in NPT-technology

- 40% lower E_{off} compared to previous generation
- Short circuit withstand time – 10 μ s
- Designed for:
 - Motor controls
 - Inverter
 - SMPS
- NPT-Technology offers:
 - very tight parameter distribution
 - high ruggedness, temperature stable behaviour
 - parallel switching capability
- Qualified according to JEDEC¹ for target applications
- Pb-free lead plating; RoHS compliant
- Complete product spectrum and PSpice Models : <http://www.infineon.com/igbt/>

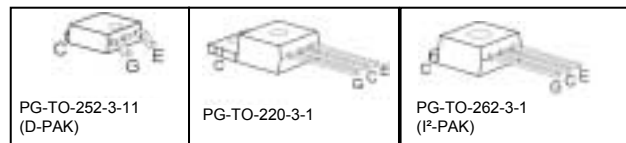
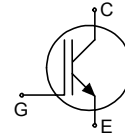

Type	V_{CE}	I_C	E_{off}	T_j	Marking	Package
SGP02N120	1200V	2A	0.11mJ	150°C	GP02N120	PG-TO-220-3-1
SGD02N120	1200V	2A	0.11mJ	150°C	02N120	PG-TO-252-3-11
SGI02N120	1200V	2A	0.11mJ	150°C	GI02N120	PG-TO-262-3-1

Maximum Ratings

Parameter	Symbol	Value	Unit
Collector-emitter voltage	V_{CE}	1200	V
DC collector current	I_C	6.2	A
$T_C = 25^\circ\text{C}$		2.8	
$T_C = 100^\circ\text{C}$		9.6	
Pulsed collector current, t_p limited by T_{jmax}	I_{Cpuls}	9.6	
Turn off safe operating area	-	9.6	
$V_{CE} \leq 1200\text{V}$, $T_j \leq 150^\circ\text{C}$			
Gate-emitter voltage	V_{GE}	± 20	V
Avalanche energy, single pulse	E_{AS}	10	mJ
$I_C = 2\text{A}$, $V_{CC} = 50\text{V}$, $R_{GE} = 25\Omega$, start at $T_j = 25^\circ\text{C}$			
Short circuit withstand time ²	t_{SC}	10	μ s
$V_{GE} = 15\text{V}$, $100\text{V} \leq V_{CC} \leq 1200\text{V}$, $T_j \leq 150^\circ\text{C}$			
Power dissipation	P_{tot}	62	W
$T_C = 25^\circ\text{C}$			
Operating junction and storage temperature	T_j , T_{stg}	-55...+150	$^\circ\text{C}$
Soldering temperature, PG-TO252 (reflow soldering, MSL3)	-	260	
Other packages: 1.6mm (0.063 in.) from case for 10s		260	

¹ J-STD-020 and JESD-022

² Allowed number of short circuits: <1000; time between short circuits: >1s.

Thermal Resistance

Parameter	Symbol	Conditions	Max. Value	Unit
Characteristic				
IGBT thermal resistance, junction – case	R_{thJC}		2.0	K/W
Thermal resistance, junction – ambient	R_{thJA}	PG-TO-220-3-1 PG-TO-262-3-1	62	
SMD version, device on PCB ¹⁾	R_{thJA}	PG-TO-252-3-11	50	

Electrical Characteristic, at $T_j = 25^\circ\text{C}$, unless otherwise specified

Parameter	Symbol	Conditions	Value			Unit
			min.	typ.	max.	
Static Characteristic						
Collector-emitter breakdown voltage	$V_{(BR)CES}$	$V_{GE}=0V, I_C=100\mu A$	1200	-	-	V
Collector-emitter saturation voltage	$V_{CE(sat)}$	$V_{GE} = 15V, I_C=2A$ $T_j=25^\circ\text{C}$ $T_j=150^\circ\text{C}$	2.5 -	3.1 3.7	3.6 4.3	
Gate-emitter threshold voltage	$V_{GE(th)}$	$I_C=100\mu A, V_{CE}=V_{GE}$	3	4	5	
Zero gate voltage collector current	I_{CES}	$V_{CE}=1200V, V_{GE}=0V$ $T_j=25^\circ\text{C}$ $T_j=150^\circ\text{C}$	- -	- -	25 100	μA
Gate-emitter leakage current	I_{GES}	$V_{CE}=0V, V_{GE}=20V$	-	-	100	nA
Transconductance	g_{fs}	$V_{CE}=20V, I_C=2A$		1.5	-	S
Dynamic Characteristic						
Input capacitance	C_{iss}	$V_{CE}=25V,$ $V_{GE}=0V,$ $f=1\text{MHz}$	-	205	250	pF
Output capacitance	C_{oss}		-	20	25	
Reverse transfer capacitance	C_{riss}		-	12	14	
Gate charge	Q_{Gate}	$V_{CC}=960V, I_C=2A$ $V_{GE}=15V$	-	11	-	nC
Internal emitter inductance measured 5mm (0.197 in.) from case	L_E		-	7	-	nH
Short circuit collector current ²⁾	$I_{C(SC)}$	$V_{GE}=15V, t_{SC}\leq 10\mu s$ $100V\leq V_{CC}\leq 1200V,$ $T_j\leq 150^\circ\text{C}$	-	24	-	A

¹⁾ Device on 50mm*50mm*1.5mm epoxy PCB FR4 with 6cm² (one layer, 70μm thick) copper area for collector connection. PCB is vertical without blown air.

²⁾ Allowed number of short circuits: <1000; time between short circuits: >1s.

Switching Characteristic, Inductive Load, at $T_j=25^\circ\text{C}$

Parameter	Symbol	Conditions	Value			Unit
			min.	typ.	max.	
IGBT Characteristic						
Turn-on delay time	$t_{d(on)}$	$T_j=25^\circ\text{C}$, $V_{CC}=800\text{V}$, $I_C=2\text{A}$, $V_{GE}=15\text{V}/0\text{V}$, $R_G=91\Omega$, $L_{\sigma}^{(1)}=180\text{nH}$, $C_{\sigma}^{(1)}=40\text{pF}$ Energy losses include "tail" and diode reverse recovery.	-	23	30	ns
Rise time	t_r		-	16	21	
Turn-off delay time	$t_{d(off)}$		-	260	340	
Fall time	t_f		-	61	80	
Turn-on energy	E_{on}		-	0.16	0.21	mJ
Turn-off energy	E_{off}		-	0.06	0.08	
Total switching energy	E_{ts}		-	0.22	0.29	

Switching Characteristic, Inductive Load, at $T_j=150^\circ\text{C}$

Parameter	Symbol	Conditions	Value			Unit
			min.	typ.	max.	
IGBT Characteristic						
Turn-on delay time	$t_{d(on)}$	$T_j=150^\circ\text{C}$ $V_{CC}=800\text{V}$, $I_C=2\text{A}$, $V_{GE}=15\text{V}/0\text{V}$, $R_G=91\Omega$, $L_{\sigma}^{(1)}=180\text{nH}$, $C_{\sigma}^{(1)}=40\text{pF}$ Energy losses include "tail" and diode reverse recovery.	-	26	31	ns
Rise time	t_r		-	14	17	
Turn-off delay time	$t_{d(off)}$		-	290	350	
Fall time	t_f		-	85	102	
Turn-on energy	E_{on}		-	0.27	0.33	mJ
Turn-off energy	E_{off}		-	0.11	0.15	
Total switching energy	E_{ts}		-	0.38	0.48	

¹⁾ Leakage inductance L_{σ} and stray capacity C_{σ} due to dynamic test circuit in figure E.

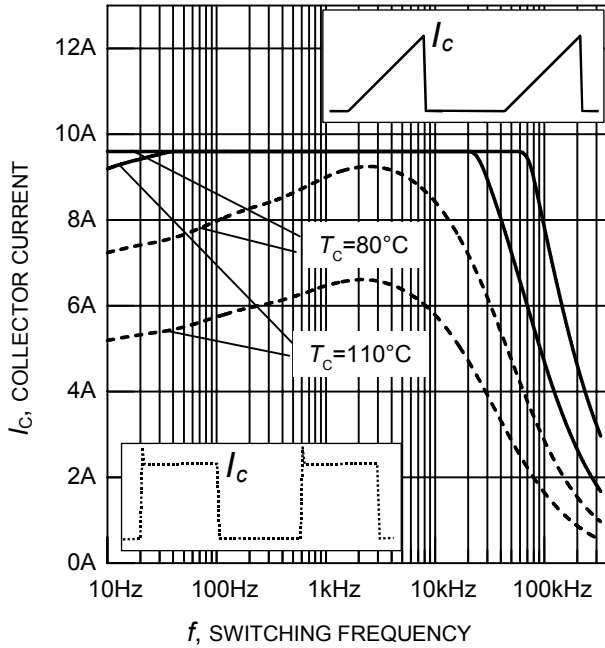

Figure 1. Collector current as a function of switching frequency

($T_j \leq 150^\circ\text{C}$, $D = 0.5$, $V_{CE} = 800\text{V}$, $V_{GE} = +15\text{V}/0\text{V}$, $R_G = 91\Omega$)

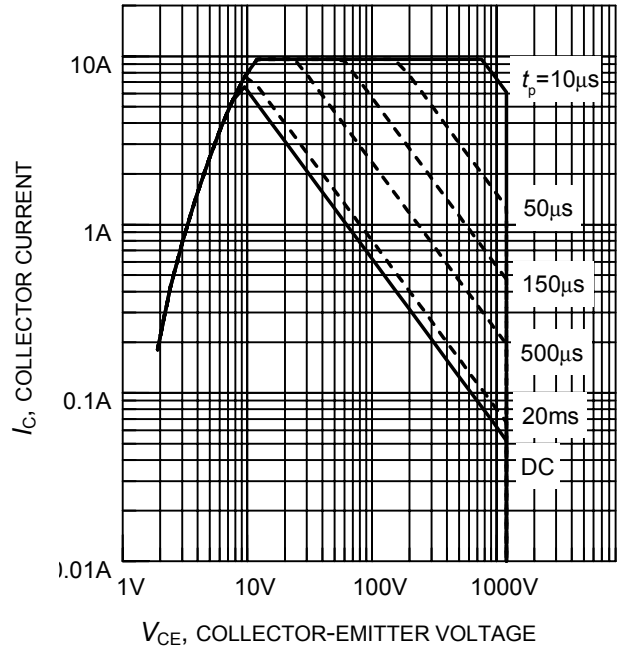

Figure 2. Safe operating area
($D = 0$, $T_C = 25^\circ\text{C}$, $T_j \leq 150^\circ\text{C}$)

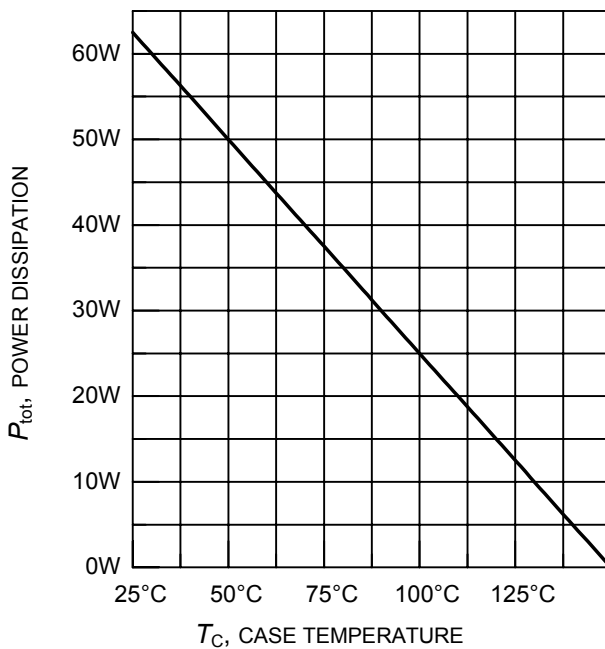

Figure 3. Power dissipation as a function of case temperature

($T_j \leq 150^\circ\text{C}$)

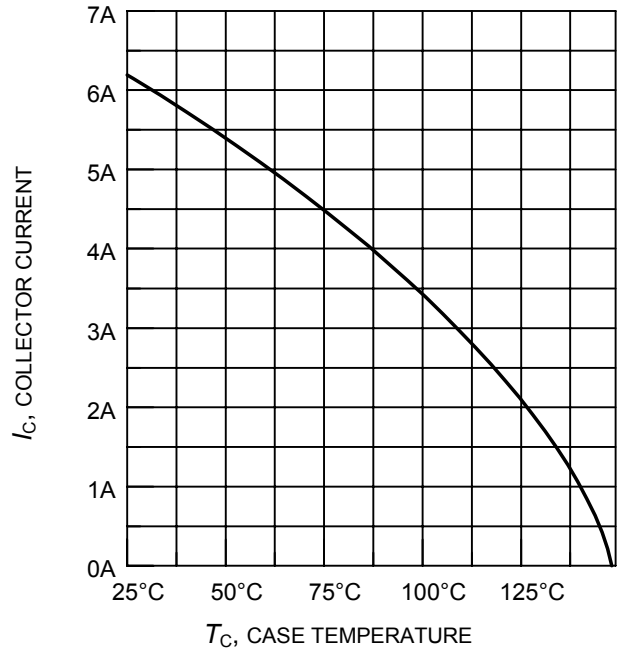

Figure 4. Collector current as a function of case temperature

($V_{GE} \leq 15\text{V}$, $T_j \leq 150^\circ\text{C}$)

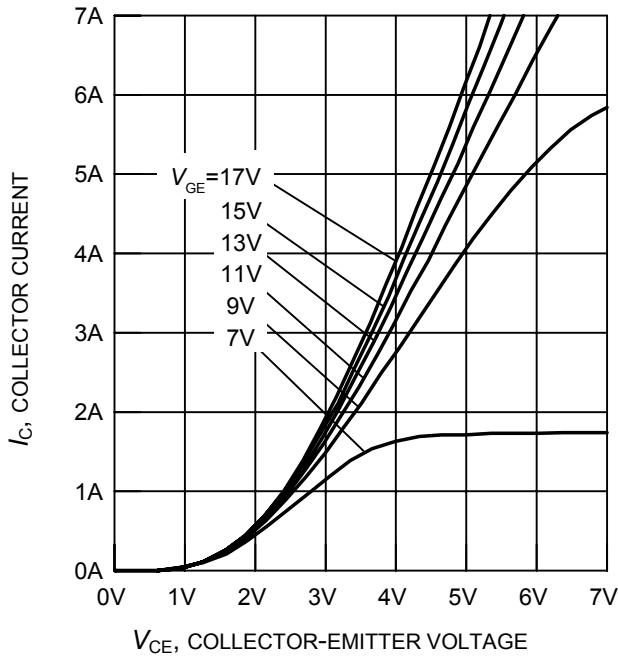

Figure 5. Typical output characteristics
($T_j = 25^\circ\text{C}$)

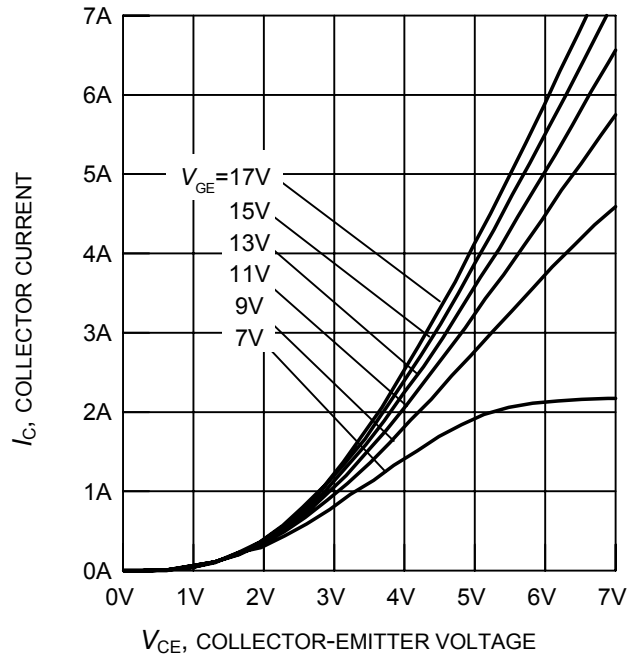

Figure 6. Typical output characteristics
($T_j = 150^\circ\text{C}$)

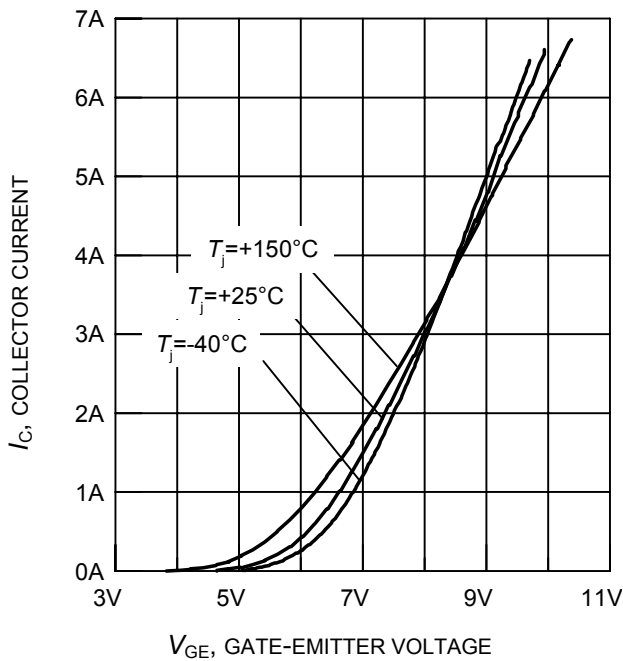

Figure 7. Typical transfer characteristics
($V_{CE} = 20\text{V}$)

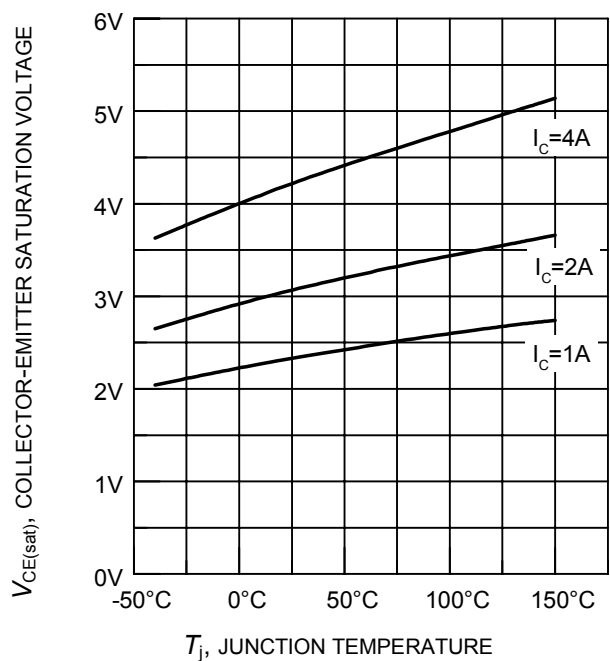

Figure 8. Typical collector-emitter saturation voltage as a function of junction temperature
($V_{GE} = 15\text{V}$)

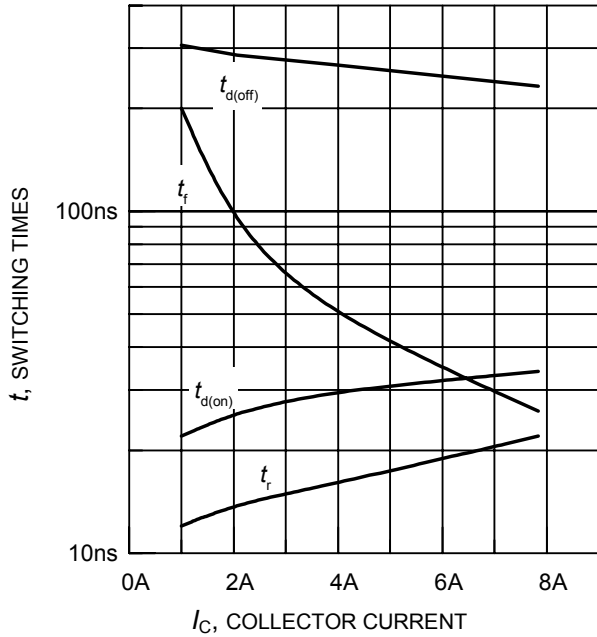

Figure 9. Typical switching times as a function of collector current
 (inductive load, $T_j = 150^\circ\text{C}$,
 $V_{CE} = 800\text{V}$, $V_{GE} = +15\text{V}/0\text{V}$, $R_G = 91\Omega$,
 dynamic test circuit in Fig.E)

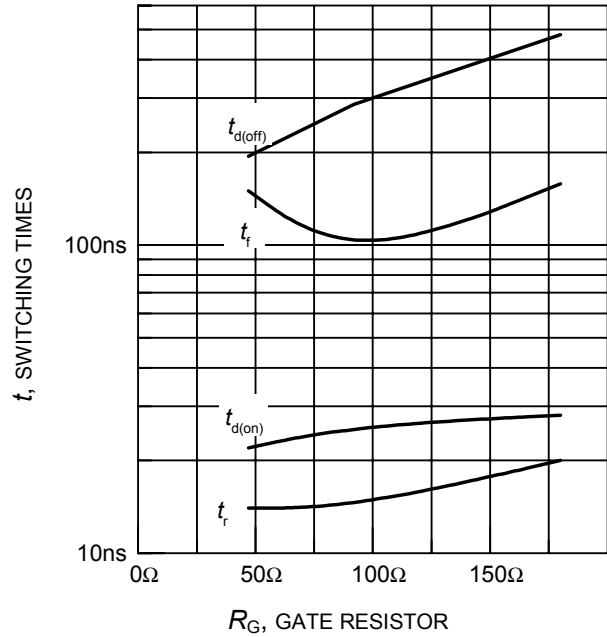

Figure 10. Typical switching times as a function of gate resistor
 (inductive load, $T_j = 150^\circ\text{C}$,
 $V_{CE} = 800\text{V}$, $V_{GE} = +15\text{V}/0\text{V}$, $I_C = 2\text{A}$,
 dynamic test circuit in Fig.E)

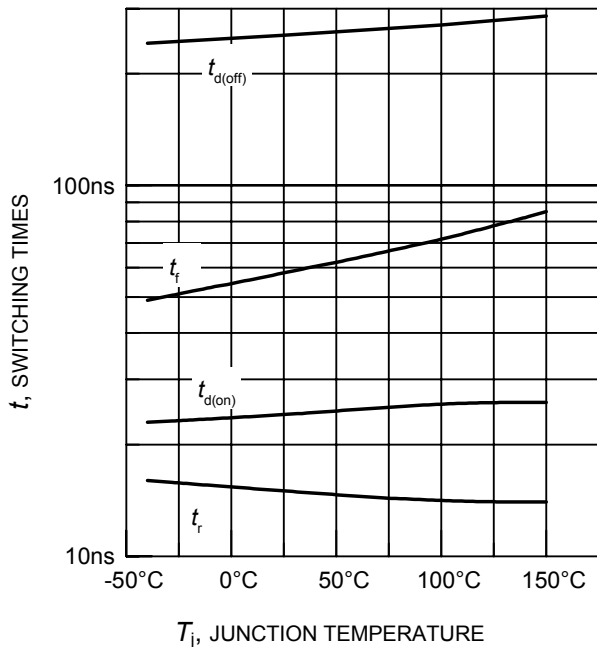

Figure 11. Typical switching times as a function of junction temperature
 (inductive load, $V_{CE} = 800\text{V}$,
 $V_{GE} = +15\text{V}/0\text{V}$, $I_C = 2\text{A}$, $R_G = 91\Omega$,
 dynamic test circuit in Fig.E)

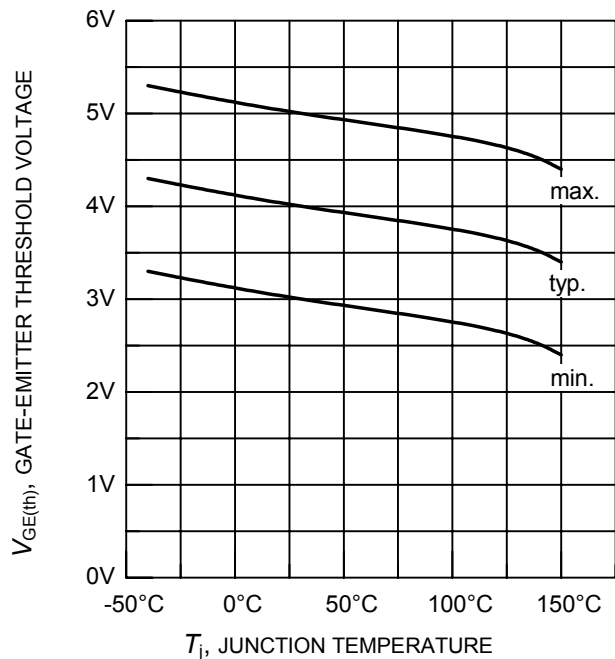

Figure 12. Gate-emitter threshold voltage as a function of junction temperature
 ($I_C = 0.3\text{mA}$)

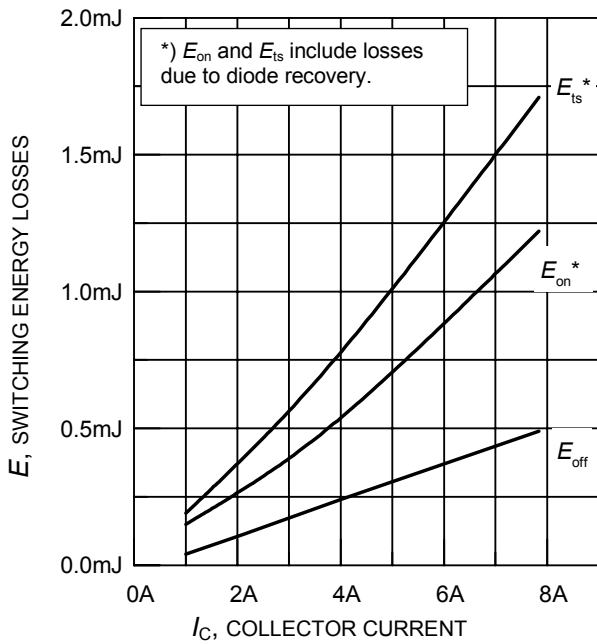

Figure 13. Typical switching energy losses as a function of collector current
(inductive load, $T_j = 150^\circ\text{C}$, $V_{CE} = 800\text{V}$, $V_{GE} = +15\text{V}/0\text{V}$, $R_G = 91\Omega$, dynamic test circuit in Fig.E)

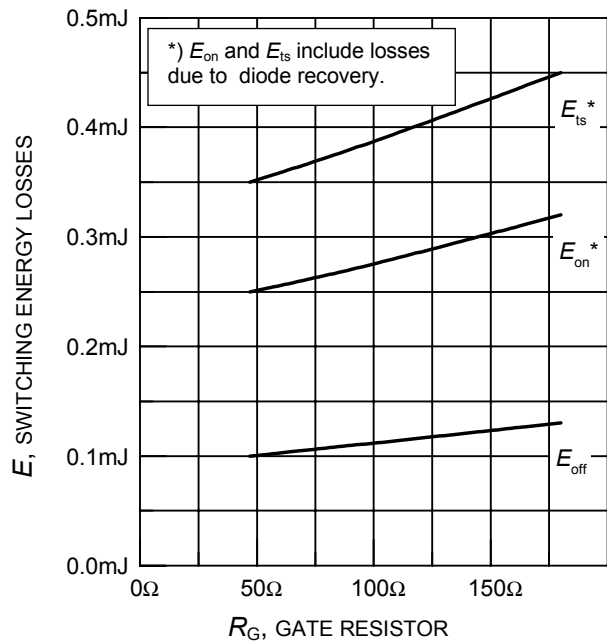

Figure 14. Typical switching energy losses as a function of gate resistor
(inductive load, $T_j = 150^\circ\text{C}$, $V_{CE} = 800\text{V}$, $V_{GE} = +15\text{V}/0\text{V}$, $I_C = 2\text{A}$, dynamic test circuit in Fig.E)

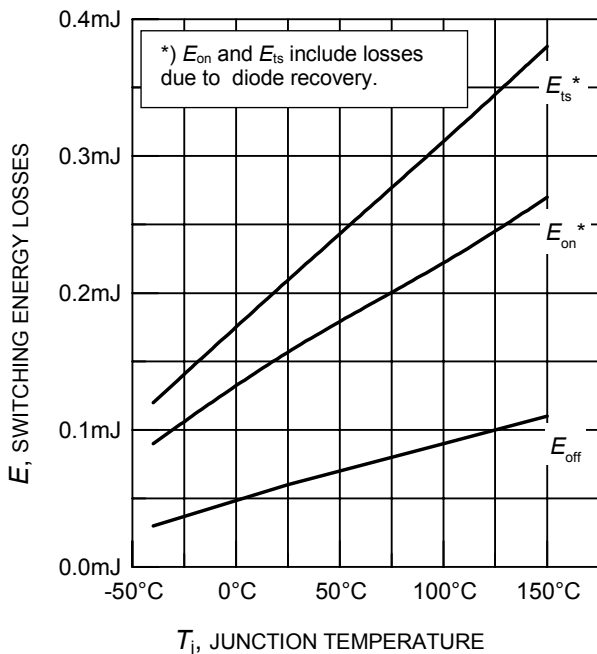

Figure 15. Typical switching energy losses as a function of junction temperature
(inductive load, $V_{CE} = 800\text{V}$, $V_{GE} = +15\text{V}/0\text{V}$, $I_C = 2\text{A}$, $R_G = 91\Omega$, dynamic test circuit in Fig.E)

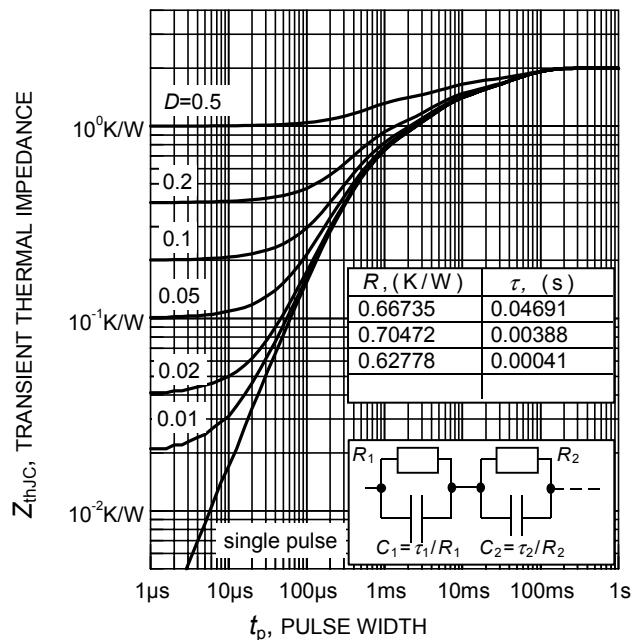

Figure 16. IGBT transient thermal impedance as a function of pulse width
($D = t_p / T$)

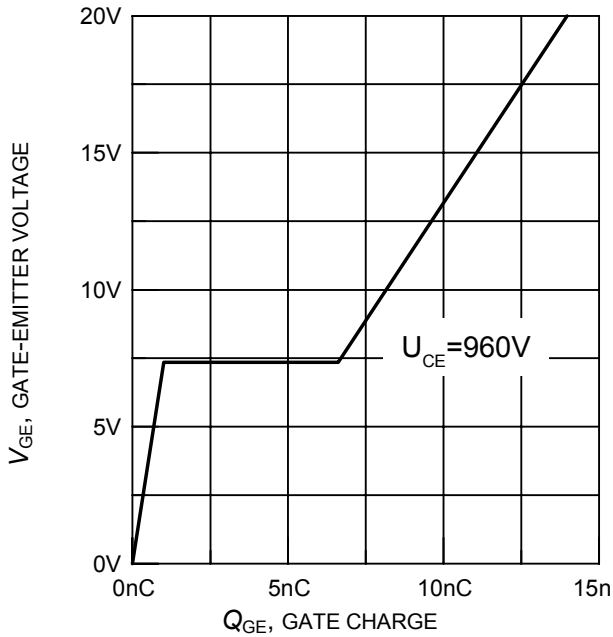

Figure 17. Typical gate charge
($I_C = 2A$)

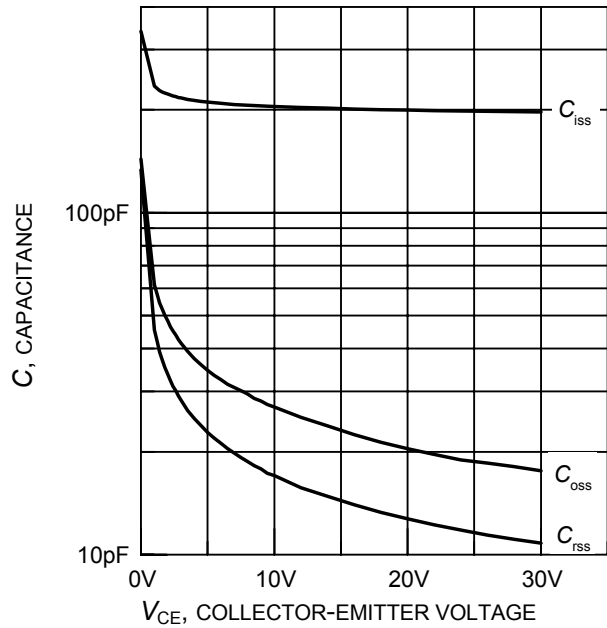

Figure 18. Typical capacitance as a function of collector-emitter voltage
($V_{GE} = 0V, f = 1MHz$)

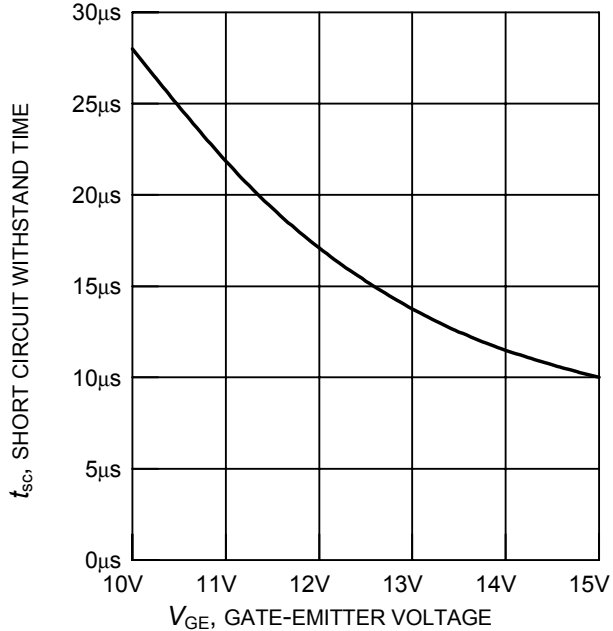

Figure 19. Short circuit withstand time as a function of gate-emitter voltage
($V_{CE} = 1200V, \text{start at } T_j = 25^\circ C$)

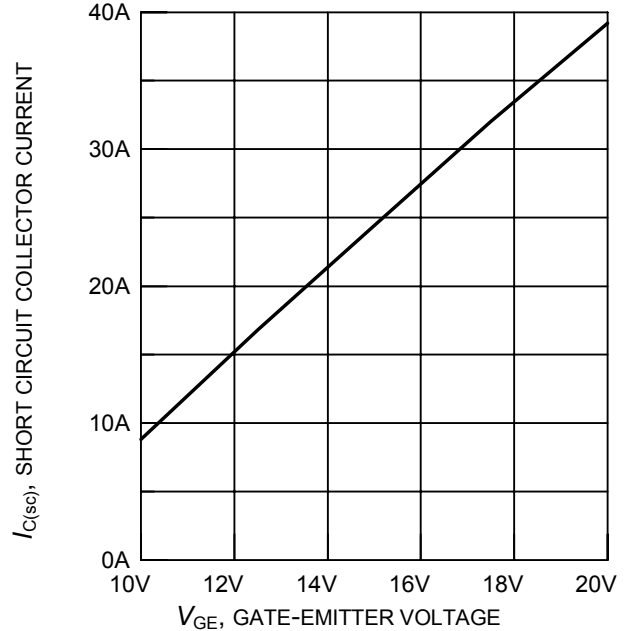
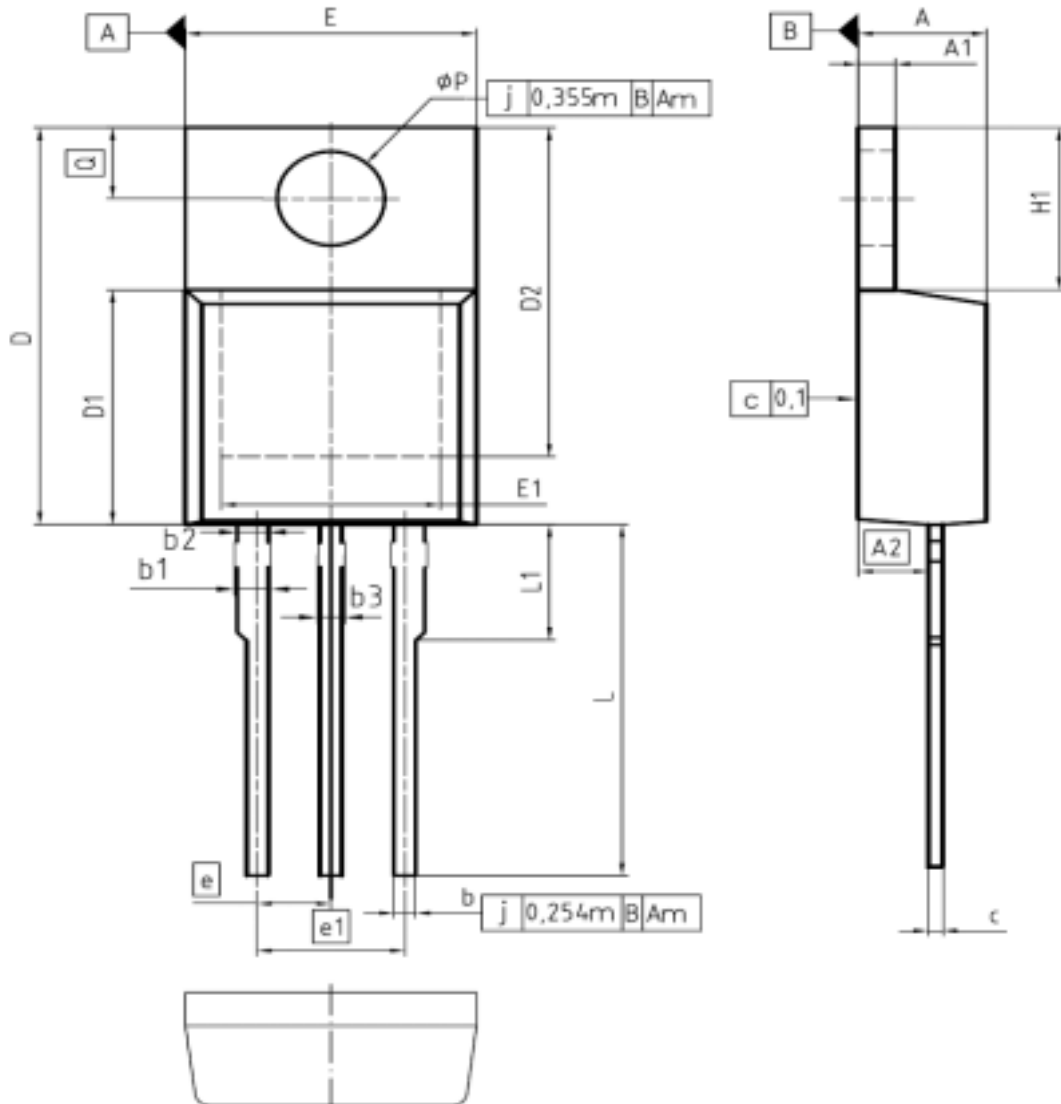

Figure 20. Typical short circuit collector current as a function of gate-emitter voltage
($100V \leq V_{CE} \leq 1200V, T_C = 25^\circ C, T_j \leq 150^\circ C$)

PG-TO220-3-1



DIM	MILLIMETERS		INCHES	
	MIN	MAX	MIN	MAX
A	4.30	4.57	0.169	0.180
A1	1.17	1.40	0.046	0.055
A2	2.15	2.72	0.085	0.107
b	0.65	0.86	0.026	0.034
b1	0.95	1.40	0.037	0.055
b2	0.95	1.15	0.037	0.045
b3	0.65	1.15	0.026	0.045
c	0.33	0.60	0.013	0.024
D	14.81	15.95	0.583	0.628
D1	8.51	9.45	0.335	0.372
D2	12.19	13.10	0.480	0.516
E	9.70	10.36	0.382	0.408
E1	6.50	8.60	0.256	0.339
e	2.54		0.100	
e1	5.08		0.200	
N	3		3	
H1	5.90	6.90	0.232	0.272
L	13.00	14.00	0.512	0.551
L1	-	4.80	-	0.189
φP	3.60	3.89	0.142	0.153
Q	2.60	3.00	0.102	0.118

DOCUMENT NO.
Z8B00003318

SCALE 0 2.5 5mm

EUROPEAN PROJECTION

ISSUE DATE
23-08-2007

REVISION
05

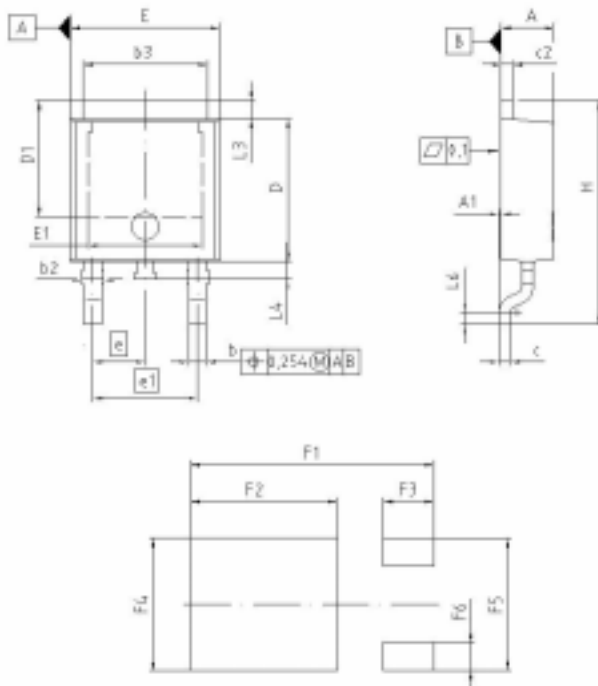

PG-TO252-3-11

DIM	MILLIMETERS		INCHES	
	MIN	MAX	MIN	MAX
A	2.194	2.388	0.086	0.094
A1	0.000	0.150	0.000	0.006
b	0.035	0.080	0.002	0.003
b2	0.050	1.450	0.002	0.045
b3	5.000	5.500	0.197	0.217
e	0.400	0.560	0.016	0.023
e2	0.400	0.960	0.016	0.039
D	5.969	6.223	0.235	0.245
D1	5.020	5.320	0.198	0.209
E	6.400	6.724	0.252	0.265
E1	4.900	5.100	0.193	0.201
e	2.298		0.900	
e1	4.572		0.180	
N	S		S	
H	0.400	10.094	0.016	0.397
L3	0.900	1.190	0.035	0.044
L4	0.950	1.010	0.038	0.040
L6	0.510	0.680	0.020	0.027
F1	10.500	10.700	0.413	0.421
F2	6.300	6.500	0.248	0.256
F3	2.800	2.300	0.083	0.091
F4	5.700	5.900	0.224	0.232
F5	5.800	5.800	0.222	0.231
F6	1.100	1.300	0.043	0.051

PG-TO262-3-1 (I² Pak)

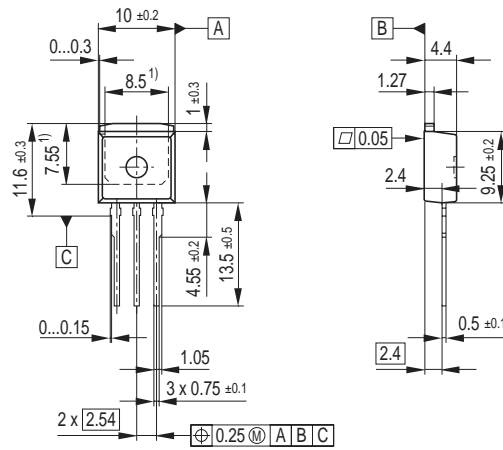

¹⁾ Typical
 Metal surface min. X = 7.25, Y = 6.9
 All metal surfaces tin plated, except area of cut.

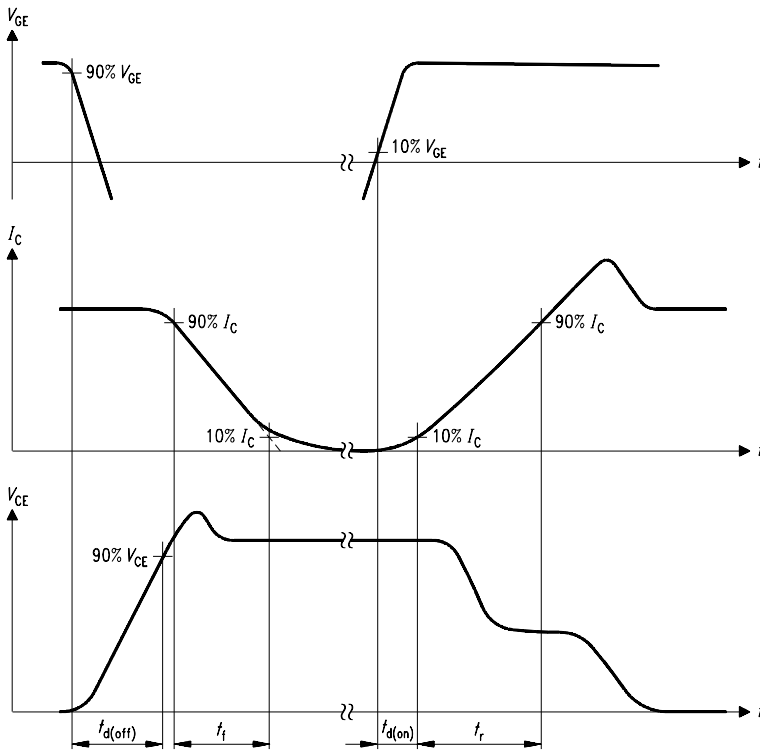

Figure A. Definition of switching times

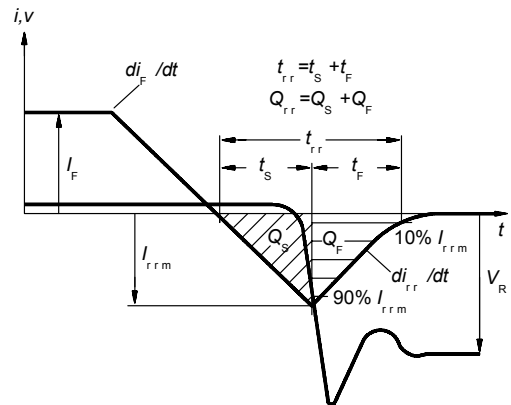

Figure C. Definition of diodes switching characteristics

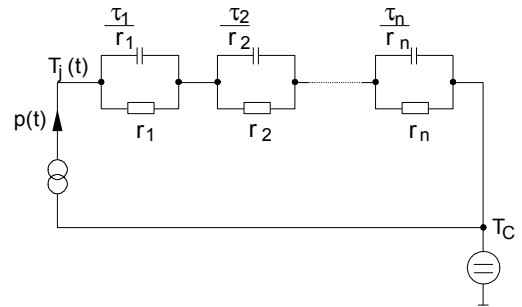

Figure D. Thermal equivalent circuit

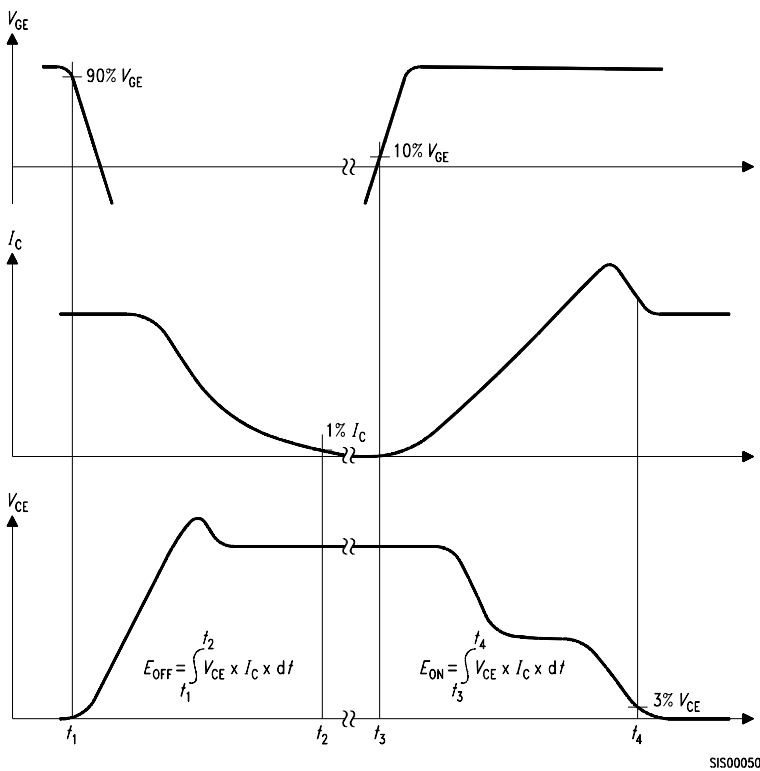
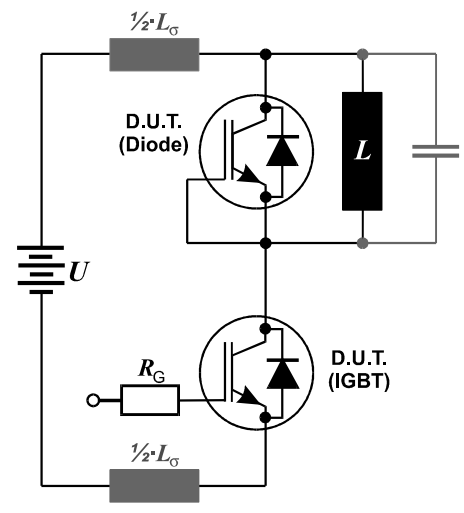

Figure B. Definition of switching losses

Figure E. Dynamic test circuit
Leakage inductance $L_{\sigma} = 180\text{nH}$,
and stray capacity $C_{\sigma} = 40\text{pF}$.



Edition 2006-01

**Published by
Infineon Technologies AG
81726 München, Germany**

© Infineon Technologies AG 9/12/07.

All Rights Reserved.

Attention please!

The information given in this data sheet shall in no event be regarded as a guarantee of conditions or characteristics ("Beschaffenheitsgarantie"). With respect to any examples or hints given herein, any typical values stated herein and/or any information regarding the application of the device, Infineon Technologies hereby disclaims any and all warranties and liabilities of any kind, including without limitation warranties of non-infringement of intellectual property rights of any third party.

Information

For further information on technology, delivery terms and conditions and prices please contact your nearest Infineon Technologies Office (www.infineon.com).

Warnings

Due to technical requirements components may contain dangerous substances. For information on the types in question please contact your nearest Infineon Technologies Office.

Infineon Technologies Components may only be used in life-support devices or systems with the express written approval of Infineon Technologies, if a failure of such components can reasonably be expected to cause the failure of that life-support device or system, or to affect the safety or effectiveness of that device or system. Life support devices or systems are intended to be implanted in the human body, or to support and/or maintain and sustain and/or protect human life. If they fail, it is reasonable to assume that the health of the user or other persons may be endangered.

Looking for pricing, stock, or lifecycle information?

Click below to explore more details on WIN SOURCE:

- ⊖ [View SGD02N120BUMA1 on WIN SOURCE](#)
- ⊖ [Infineon Technologies Information](#)

Optimize Your Supply Chain with WIN SOURCE Solutions

- ✓ Global Sourcing Solution
- ✓ Obsolete Management
- ✓ Cost Control Management
- ✓ Shortage Management
- ✓ Alternative Solution
- ✓ Excess Inventory Management