



Is Now Part of



**ON Semiconductor®**

To learn more about ON Semiconductor, please visit our website at  
[www.onsemi.com](http://www.onsemi.com)

Please note: As part of the Fairchild Semiconductor integration, some of the Fairchild orderable part numbers will need to change in order to meet ON Semiconductor's system requirements. Since the ON Semiconductor product management systems do not have the ability to manage part nomenclature that utilizes an underscore (\_), the underscore (\_) in the Fairchild part numbers will be changed to a dash (-). This document may contain device numbers with an underscore (\_). Please check the ON Semiconductor website to verify the updated device numbers. The most current and up-to-date ordering information can be found at [www.onsemi.com](http://www.onsemi.com). Please email any questions regarding the system integration to [Fairchild\\_questions@onsemi.com](mailto:Fairchild_questions@onsemi.com).

ON Semiconductor and the ON Semiconductor logo are trademarks of Semiconductor Components Industries, LLC dba ON Semiconductor or its subsidiaries in the United States and/or other countries. ON Semiconductor owns the rights to a number of patents, trademarks, copyrights, trade secrets, and other intellectual property. A listing of ON Semiconductor's product/patent coverage may be accessed at [www.onsemi.com/site/pdf/Patent-Marking.pdf](http://www.onsemi.com/site/pdf/Patent-Marking.pdf). ON Semiconductor reserves the right to make changes without further notice to any products herein. ON Semiconductor makes no warranty, representation or guarantee regarding the suitability of its products for any particular purpose, nor does ON Semiconductor assume any liability arising out of the application or use of any product or circuit, and specifically disclaims any and all liability, including without limitation special, consequential or incidental damages. Buyer is responsible for its products and applications using ON Semiconductor products, including compliance with all laws, regulations and safety requirements or standards, regardless of any support or applications information provided by ON Semiconductor. "Typical" parameters which may be provided in ON Semiconductor data sheets and/or specifications can and do vary in different applications and actual performance may vary over time. All operating parameters, including "Typicals" must be validated for each customer application by customer's technical experts. ON Semiconductor does not convey any license under its patent rights nor the rights of others. ON Semiconductor products are not designed, intended, or authorized for use as a critical component in life support systems or any FDA Class 3 medical devices or medical devices with a same or similar classification in a foreign jurisdiction or any devices intended for implantation in the human body. Should Buyer purchase or use ON Semiconductor products for any such unintended or unauthorized application, Buyer shall indemnify and hold ON Semiconductor and its officers, employees, subsidiaries, affiliates, and distributors harmless against all claims, costs, damages, and expenses, and reasonable attorney fees arising out of, directly or indirectly, any claim of personal injury or death associated with such unintended or unauthorized use, even if such claim alleges that ON Semiconductor was negligent regarding the design or manufacture of the part. ON Semiconductor is an Equal Opportunity/Affirmative Action Employer. This literature is subject to all applicable copyright laws and is not for resale in any manner.

# SG6961

## Critical Conduction Mode PFC Controller

### Features

- Boundary Mode PFC Controller
- Low Input Current THD
- Controlled On-Time PWM
- Zero-Current Detection
- Cycle-by-cycle Current Limiting
- Leading-Edge Blanking Instead of RC Filtering
- Low Startup Current: 10 $\mu$ A (Typical)
- Low Operating Current: 4.5mA (Typical)
- Feedback Open-Loop Protection
- Programmable Maximum On-Time
- Output Over-Voltage Clamping Protection
- Clamped Gate Output Voltage 16.5V

### Description

The SG6961 is an 8-pin boundary mode PFC controller IC intended for controlling PFC pre-regulators. The SG6961 provides a controlled on-time to regulate the output DC voltage and achieve natural power factor correction. The maximum on-time of the external switch is programmable to ensure safe operation during AC brownouts. An innovative multi-vector error amplifier is built in to provide rapid transient response and precise output voltage clamping. A built-in circuit disables the controller if the output feedback loop is opened. The startup current is lower than 20 $\mu$ A and the operating current is under 4.5mA. The supply voltage can be up to 20V, maximizing application flexibility.

### Applications

- Electric Lamp Ballasts
- AC-DC Switching Mode Power Converter
- Open-Frame Power Supplies and Power Adapters

### Ordering Information

Part Number	Operating Temperature Range	Package	Packing Method
SG6961SZ	-30°C to +85°C	8-Pin Small Outline Package (SOP)	Tape & Reel
SG6961DZ	-30°C to +85°C	8-Pin Dual Inline Package (DIP)	Tube
SG6961SY	-30°C to +85°C	8-Pin Small Outline Package (SOP)	Tape & Reel



### Marking Information

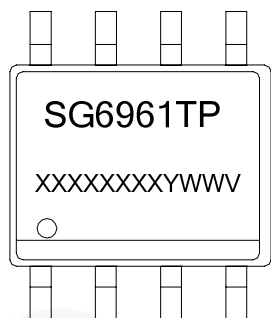

T- D=DIP, S=SOP  
 P- Z=Lead Free + ROHS Compatible  
 Null=Regular Package  
 XXXXXXXXX- Wafer Lot  
 Y: Year; WW: Week  
 V: Assembly Location

- ※ Marking for SG6961SZ (pb-free)
- ※ Marking for SG6961DZ (pb-free)

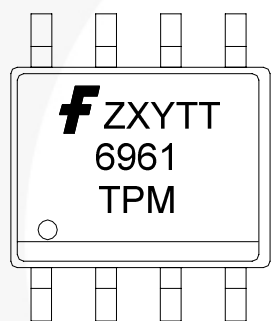

**f**: Fairchild Logo  
 Z: Plant Code  
 X: Year Code  
 Y: Week Code  
 TT: Die Run Code  
 T: Package Type (S = SOP)  
 P: Y = Green Compound  
 M: Manufacturing Flow Code

- ※ Marking for SG6961SY (Green-Compound)

Figure 3. Top Mark

## Pin Configuration

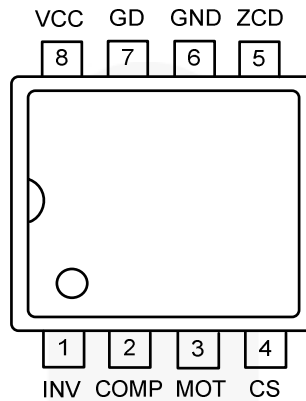

Figure 4. Pin Configuration

## Pin Definitions

Pin #	Name	Description
1	INV	<b>Inverting Input of the Error Amplifier.</b> INV is connected to the converter output via a resistive divider. This pin is also used for over-voltage clamping and open-loop feedback protection.
2	COMP	<b>The Output of the Error Amplifier.</b> To create a precise clamping protection, a compensation network between this pin and GND is suggested.
3	MOT	<b>Maximum On Time.</b> A resistor from MOT to GND is used to determine the maximum on-time of the external power MOSFET. The maximum output power of the converter is a function of the maximum on time.
4	CS	<b>Current Sense.</b> Input to the over-current protection comparator. When the sensed voltage across the sense resistor reaches the internal threshold (0.8V), the switch is turned off to activate cycle-by-cycle current limiting.
5	ZCD	<b>Zero Current Detection.</b> This pin is connected to an auxiliary winding via a resistor to detect the zero crossing of the switch current. When the zero crossing is detected, a new switching cycle is started. If it is connected to GND, the device is disabled.
6	GND	<b>Ground.</b> The power ground and signal ground. Placing a 0.1 $\mu$ F decoupling capacitor between VCC and GND is recommended.
7	GD	<b>Driver Output.</b> Totem-pole driver output to drive the external power MOSFET. The clamped gate output voltage is 16.5V.
8	VCC	<b>Power Supply.</b> Driver and control circuit supply voltage.

## Absolute Maximum Ratings

Stresses exceeding the absolute maximum ratings may damage the device. The device may not function or be operable above the recommended operating conditions and stressing the parts to these levels is not recommended. In addition, extended exposure to stresses above the recommended operating conditions may affect device reliability. The absolute maximum ratings are stress ratings only.

Symbol	Parameter	Min.	Max.	Unit
V <sub>VCC</sub>	DC Supply Voltage		25	V
V <sub>HIGH</sub>	Gate Driver	-0.3	25.0	V
V <sub>LOW</sub>	Others (INV, COMP, MOT, CS)	-0.3	7.0	V
V <sub>ZCD</sub>	Input Voltage to ZCD Pin	-0.3	12.0	V
P <sub>D</sub>	Power Dissipation	SOP	400	mW
		DIP	800	
T <sub>J</sub>	Operating Junction Temperature	-40	+150	°C
θ <sub>JA</sub>	Thermal Resistance; Junction-to-Air	SOP	62.70	°C/W
		DIP	48.45	
T <sub>STG</sub>	Storage Temperature Range	-55	+150	°C
T <sub>L</sub>	Lead Temperature (Wave Soldering or IR, 10 Seconds)	SOP	+230	°C
		DIP	+260	
ESD	Electrostatic Discharge Capability	Human Body Model, JESD22-A114	2	KV
		Machine Model, JESD22-A115	200	V

### Notes:

- All voltage values, except differential voltage, are given with respect to GND pin.
- Stresses beyond those listed under “absolute maximum ratings” may cause permanent damage to the device.

## Recommended Operating Conditions

The Recommended Operating Conditions table defines the conditions for actual device operation. Recommended operating conditions are specified to ensure optimal performance to the datasheet specifications. Fairchild does not recommend exceeding them or designing to Absolute Maximum Ratings.

Symbol	Parameter	Min.	Max.	Unit
T <sub>A</sub>	Operating Ambient Temperature	-30	+85	°C

## Electrical Characteristics

$V_{CC}=15V$ ,  $T_A=25^{\circ}C$ , unless otherwise specified.

Symbol	Parameter	Conditions	Min.	Typ.	Max.	Units
<b>V<sub>CC</sub> Section</b>						
$V_{CC-OP}$	Continuous Operation Voltage				20	V
$V_{CC-ON}$	Turn-on Threshold Voltage		11	12	13	V
$V_{CC-OFF}$	Turn-off Threshold Voltage		8.5	9.5	10.5	V
$I_{CC-ST}$	Startup Current	$V_{CC}=V_{CC-ON} - 0.16V$		10	20	$\mu A$
$I_{CC-OP}$	Operating Supply Current	$V_{CC}=12V$ , $V_{CS}=0V$ , $C_L=3nF$ , $f_{SW}=60KHz$		4.5	6.0	mA
$V_{CC-OVP}$	V <sub>DD</sub> Over-Voltage Protection Level			24		V
$t_{D-VCCOVP}$	V <sub>DD</sub> Over-Voltage Protection Debounce			30		$\mu s$
<b>Error Amplifier Section</b>						
$V_{REF}$	Reference Voltage		2.475	2.500	2.525	V
G <sub>m</sub>	Transconductance	$T_A=25^{\circ}C$	100	125	150	$\mu\Omega$
$V_{INVH}$	Clamp High Feedback Voltage			2.65	2.70	V
$V_{INVL}$	Clamp Low Feedback Voltage		2.25	2.30		V
$V_{OUT-HIGH}$	Output High Voltage		4.8			V
$V_{OZ}$	Zero Duty Cycle Output Voltage		1.15	1.25	1.35	V
$V_{INV-OVP}$	Over Voltage Protection for INV Input			2.75		V
$V_{INV-UVP}$	Under Voltage Protection for INV Input		0.40	0.45	0.50	V
$I_{COMP}$	Source Current	$V_{INV}=2.35V$ , $V_{COMP}=1.5V$	7	20		$\mu A$
		$V_{INV}=1.5V$ ,	450	800		
	Sink Current	$V_{INV}=2.65V$ , $V_{COMP}=5V$	10	20		

Continued on the following page...

## Electrical Characteristics

$V_{CC}=15V$ ,  $T_A=25^{\circ}C$ , unless otherwise specified.

Symbol	Parameter	Conditions	Min.	Typ.	Max.	Units
<b>Current-Sense Section</b>						
$V_{PK}$	Threshold Voltage for Peak Current Limit Cycle-by-Cycle Limit		0.77	0.82	0.87	V
$t_{PD}$	Propagation Delay				200	ns
$t_{LEB}$	Leading-Edge Blanking Time	$R_{MOT}=24k\Omega$		400	500	ns
<b>Gate Section</b>						
$V_{ZOUT}$	Output Voltage Maximum (Clamp)	$V_{CC}=20V$	15.5	16.5	17.5	V
$V_{OL}$	Output Voltage Low	$V_{CC}=15V$ , $I_O=100mA$			1.4	V
$V_{OH}$	Output Voltage High	$V_{CC}=14V$ , $I_O=100mA$	8			V
$t_R$	Rising Time	$V_{CC}=12V$ , $C_L=3nF$ , 20~80%	50	80	160	ns
$t_F$	Falling Time	$V_{CC}=12V$ , $C_L=3nF$ , 80~20%	30	40	70	
<b>Zero Current Detection Section</b>						
$V_{ZCD}$	Input Threshold Voltage Rising Edge	$V_{ZCD}$ Increasing	1.9	2.1	2.3	V
$H_{YS}$ of $V_{ZCD}$	Threshold Voltage Hysteresis	$V_{ZCD}$ Decreasing	0.25	0.35	0.50	V
$V_{ZCD-HIGH}$	Upper Clamp Voltage	$I_{ZCD}=3mA$	8	10	12	V
$V_{ZCD-LOW}$	Lower Clamp Voltage	$I_{ZCD}=-0.5mA$	0			V
$t_{DEAD}$	Maximum Delay, ZCD to Output Turn-On	$V_{COMP}=5V$ , $f_{SW}=60KHz$	100		400	ns
$t_{RESTART}$	Restart Time	Output Turned Off by ZCD	300	500	700	$\mu s$
$t_{INHIB}$	Inhibit Time (Maximum Switching Frequency Limit)	$R_{MOT}=24k\Omega$	1.5	2.5	3.0	$\mu s$
$V_{DIS}$	Disable Threshold Voltage		200	250	300	mV
$t_{ZCD-DIS}$	Disable Function Debounce Time	$R_{MOT}=24k\Omega$ , $V_{ZCD}=100mV$	800			$\mu s$
<b>Maximum On-Time Section</b>						
$V_{MOT}$	Maximum On Time Voltage		1.25	1.30	1.35	V
$t_{ON-MAX}$	Maximum On Time Programming (Resistor Based)	$R_{MOT}=24k\Omega$ , $V_{CS}=0V$ , $V_{COMP}=5V$	21	25	27	$\mu s$

## Typical Performance Characteristics

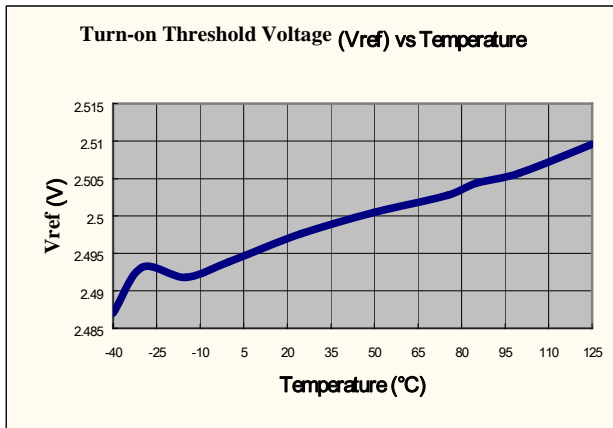

Figure 5. Turn-On Threshold Voltage

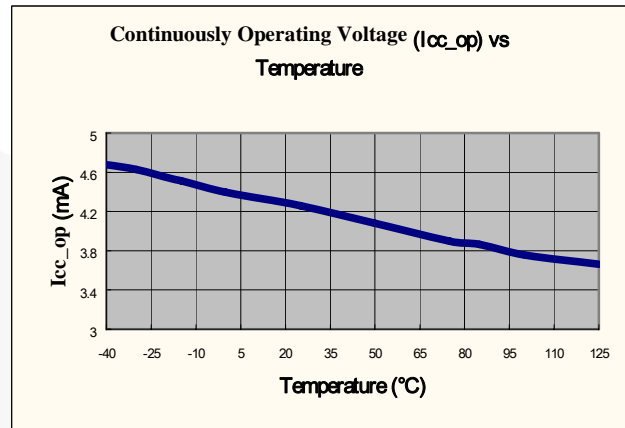

Figure 6. Continuously Operating Voltage

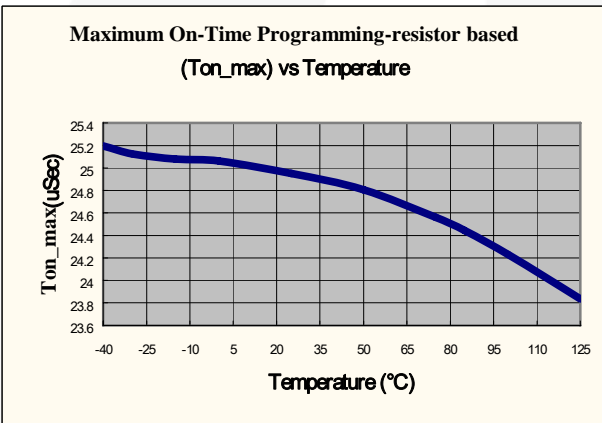

Figure 7. Maximum On-Time

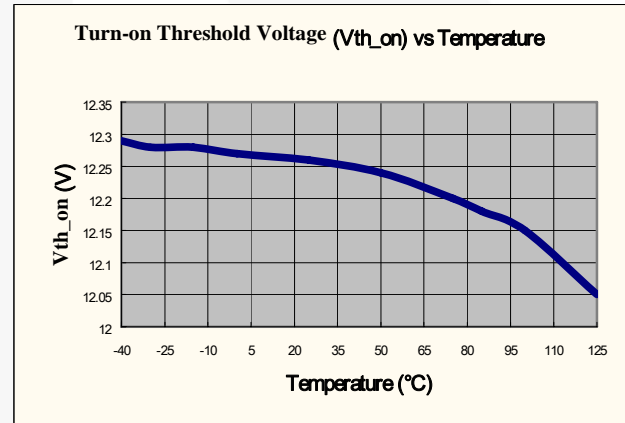

Figure 8. Turn-On Threshold Voltage

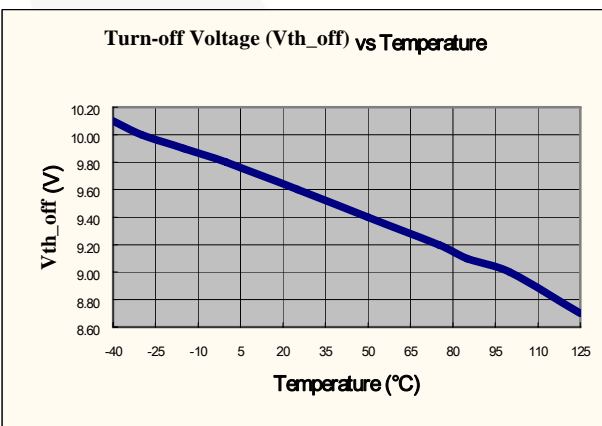

Figure 9. Turn-Off Voltage

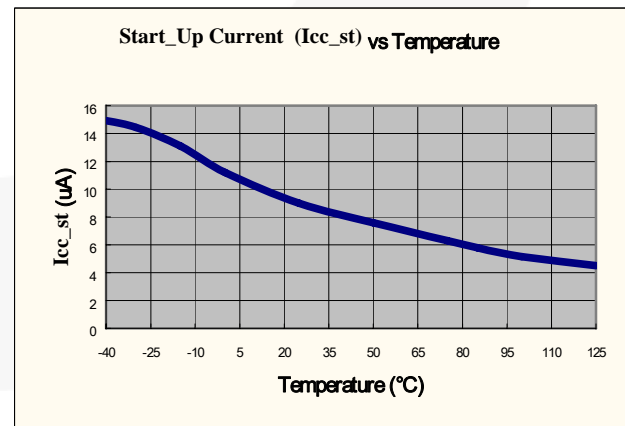

Figure 10. Startup Current

## Typical Performance Characteristics (Continued)

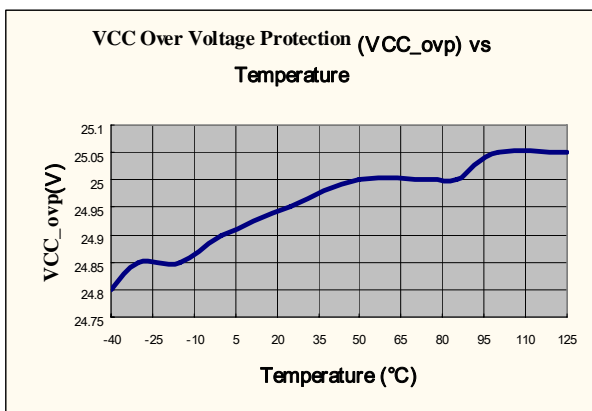

Figure 11. V<sub>CC</sub> Over-Voltage Protection

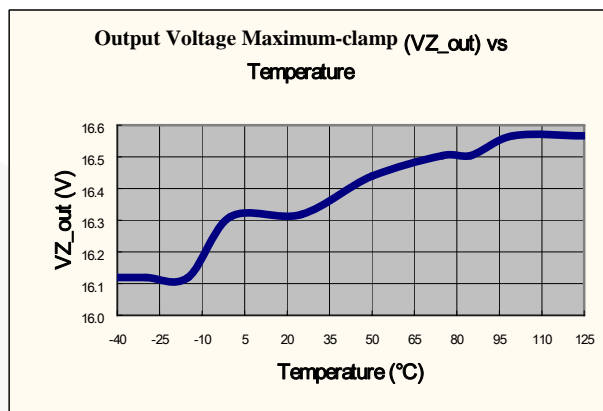

Figure 12. Output Voltage Maximum-Clamp

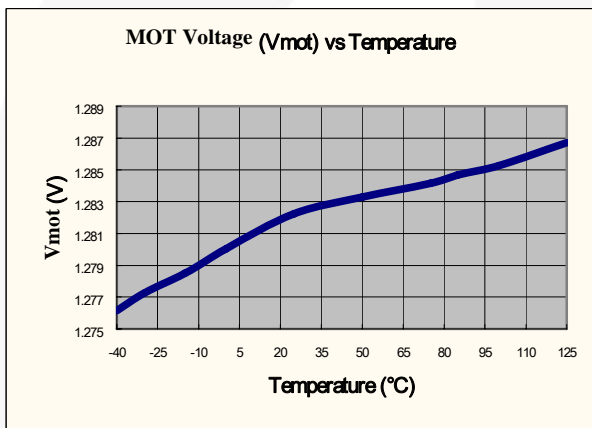

Figure 13. MOT Voltage

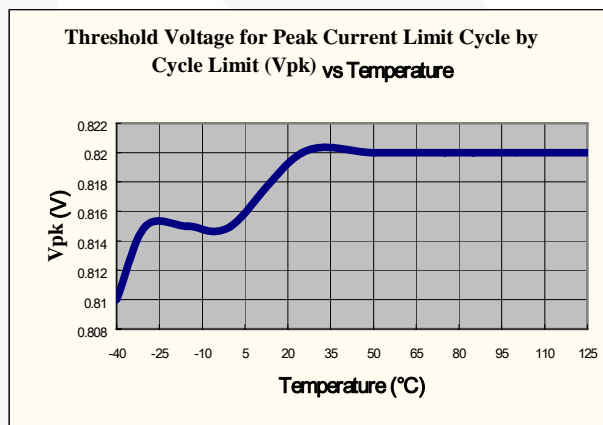

Figure 14. Threshold Voltage for Peak Current Limit

## Functional Description

### Error Amplifier

The inverting input of the error amplifier is referenced to INV. The output of the error amplifier is referenced to COMP. The non-inverting input is internally connected to a fixed  $2.5V \pm 2\%$  voltage. The output of the error amplifier is used to determine the on-time of the PWM output and regulate the output voltage. To achieve a low input current THD, the variation of the on time within one input AC cycle should be very small. A multi-vector error amplifier is built in to provide fast transient response and precise output voltage clamping.

For SG6961, connecting a capacitance, such as  $1\mu F$ , between COMP and GND is suggested. The error amplifier is a trans-conductance amplifier that converts voltage to current with a  $125\mu mho$ .

### Startup Current

Typical startup current is less than  $20\mu A$ . This ultra-low startup current allows the usage of high resistance, low-wattage startup resistor. For example,  $1 M\Omega/0.25W$  startup resistor and a  $10\mu F/25V$  ( $V_{CC}$  hold-up) capacitor are recommended for an AC-to-DC power adaptor with a wide input range 85 to  $265V_{AC}$ .

### Operating Current

Operating current is typically  $4.5mA$ . The low operating current enables a better efficiency and reduces the requirement of  $V_{CC}$  hold-up capacitance.

### Maximum On-Time Operation

Given a fixed inductor value and maximum output power, the relationship between on-time and line voltage is:

$$t_{ON} = \frac{2 \cdot L \cdot P_O}{V_{rms}^2 \cdot \eta} \quad (1)$$

If the line voltage is too low or the inductor value is too high,  $t_{ON}$  is too long. To avoid extra low operating frequency and achieve brownout protection, the maximum value of  $t_{ON}$  is programmable by one resistor,  $R_I$ , connected between MOT and GND. A  $24k\Omega$  resistor  $R_I$  generates corresponds to  $25\mu s$  maximum on time:

$$t_{ONMAX} = R_I(k\Omega) \cdot \frac{25}{24}(\mu s) \quad (2)$$

The range of the maximum on-time is designed as  $10 \sim 50\mu s$ .

### Peak Current Limiting

The switch current is sensed by one resistor. The signal is feed into CS pin and an input terminal of a comparator. A high voltage in CS pin terminates a switching cycle immediately and cycle-by-cycle current limit is achieved. The designed threshold of the protection point is  $0.82V$ .

### Leading-Edge Blanking (LEB)

A turn-on spike on CS pin appears when the power MOSFET is switched on. At the beginning of each switching pulse, the current-limit comparator is disabled for around  $400ns$  to avoid premature termination. The gate drive output cannot be switched off during the blanking period. Conventional RC filtering is not necessary, so the propagation delay of current limit protection can be minimized.

### Under-Voltage Lockout (UVLO)

The turn-on and turn-off threshold voltage is fixed internally at  $12V/9.5V$ . This hysteresis behavior guarantees a one-shot startup with proper startup resistor and hold-up capacitor. With an ultra-low startup current of  $20\mu A$ , one  $1M\Omega R_{IN}$  is sufficient for startup under low input line voltage,  $85V_{rms}$ . Power dissipation on  $R_{IN}$  would be less than  $0.1W$  even under high line ( $V_{AC}=265V_{rms}$ ) condition.

### Output Driver

With low on resistance and high current driving capability, the output driver can drive an external capacitive load larger than  $3000pF$ . Cross conduction current has been avoided to minimize heat dissipation, improving efficiency and reliability. This output driver is internally clamped by a  $16.5V$  Zener diode.

### Zero-Current Detection (ZCD)

The zero-current detection of the inductor is achieved using its auxiliary winding. When the stored energy of the inductor is fully released to output, the voltage on ZCD goes down and a new switching cycle is enabled after a ZCD trigger. The power MOSFET is always turned on with zero inductor current such that turn-on loss and noise can be minimized. The converter works in boundary mode and peak inductor current is always exactly twice of the average current. A natural power factor correction function is achieved with the low-bandwidth, on-time modulation. An inherent maximum off time is built in to ensure proper startup operation. This ZCD pin can be used as a synchronous input.

### Noise Immunity

Noise on the current sense or control signal can cause significant pulse-width jitter, particularly in the boundary-mode operation. Slope compensation and built-in debounce circuit can alleviate this problem. Because the SG6961 has a single ground pin, high sink current at the output cannot be returned separately. Good high-frequency or RF layout practices should be followed. Avoiding long PCB traces and component leads, locating compensation and filter components near to the FAN6961, and increasing the power MOSFET gate resistance improve performance.



Physical Dimensions

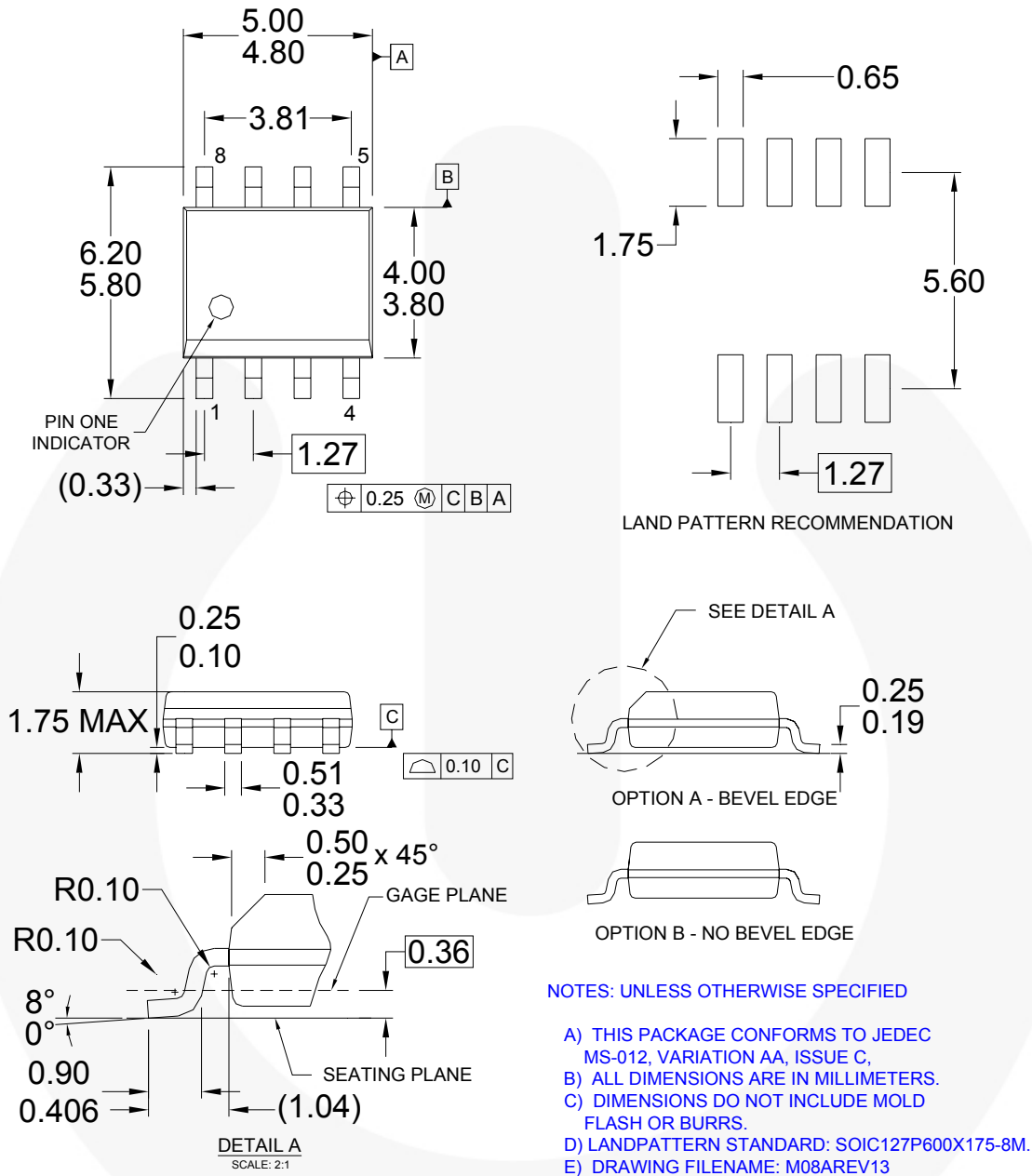
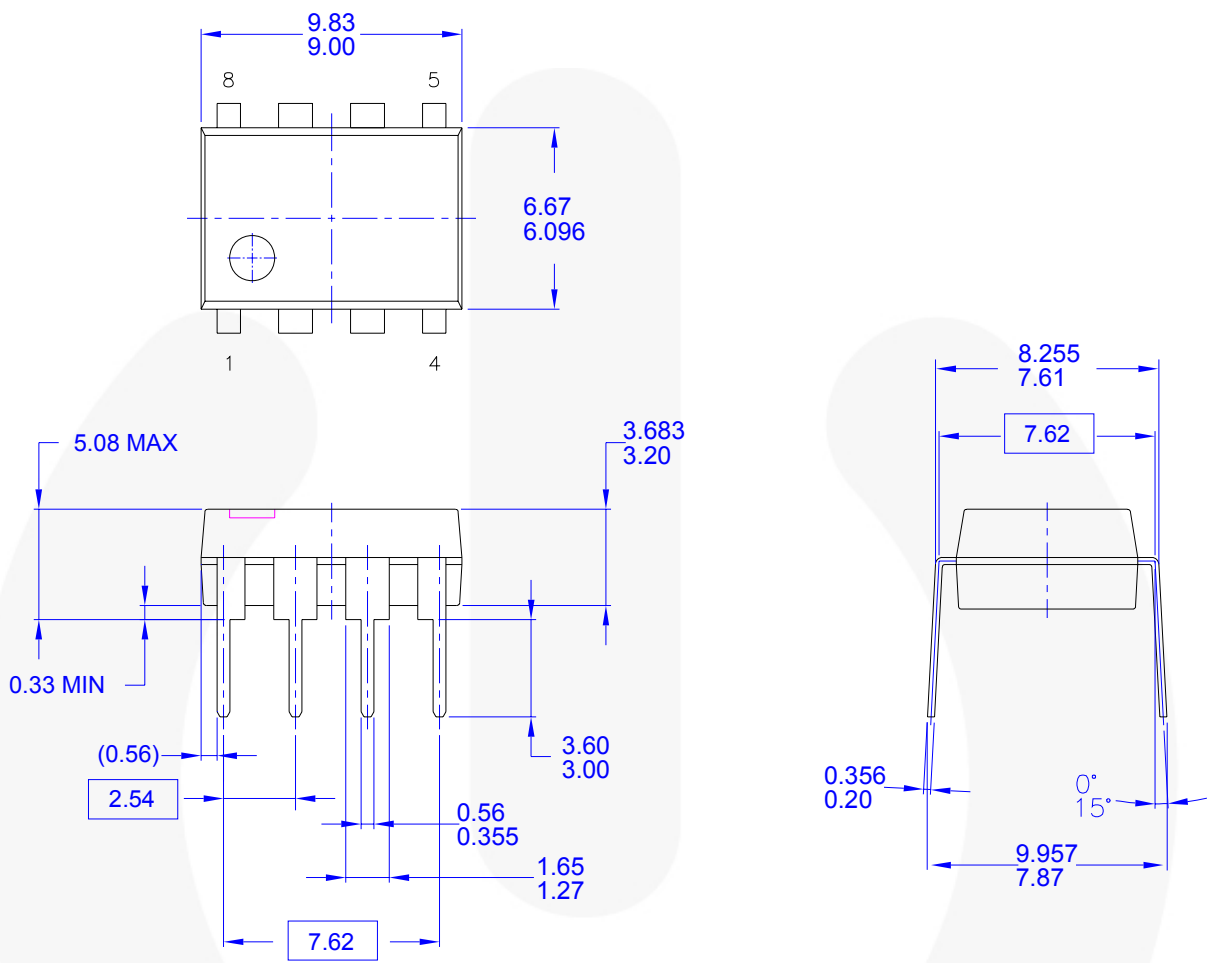

Figure 16. 8-Pin, Small Outline Package (SOP)

Package drawings are provided as a service to customers considering Fairchild components. Drawings may change in any manner without notice. Please note the revision and/or date on the drawing and contact a Fairchild Semiconductor representative to verify or obtain the most recent revision. Package specifications do not expand the terms of Fairchild's worldwide terms and conditions, specifically the warranty therein, which covers Fairchild products.

Always visit Fairchild Semiconductor's online packaging area for the most recent package drawings:  
<http://www.fairchildsemi.com/packaging/>

Physical Dimensions (Continued)



NOTES: UNLESS OTHERWISE SPECIFIED

- A) THIS PACKAGE CONFORMS TO JEDEC MS-001 VARIATION BA
- B) ALL DIMENSIONS ARE IN MILLIMETERS.
- C) DIMENSIONS ARE EXCLUSIVE OF BURRS, MOLD FLASH, AND TIE BAR EXTRUSIONS.
- D) DIMENSIONS AND TOLERANCES PER ASME Y14.5M-1994
- E) DRAWING FILENAME AND REVISION: MKT-N08FREV2.

Figure 17. 8-Pin, Dual In-Line Package (DIP)



**TRADEMARKS**

The following includes registered and unregistered trademarks and service marks, owned by Fairchild Semiconductor and/or its global subsidiaries, and is not intended to be an exhaustive list of all such trademarks.

- |                          |                                     |                                       |  |
|--------------------------|-------------------------------------|---------------------------------------|--|
| AccuPower™               | F-PFS™                              | Power-SPM™                            | <p><b>SYSTEM GENERAL</b><br/>The Power Franchise®</p> <p><b>the power franchise</b></p> <p>TinyBoost™</p> <p>TinyBuck™</p> <p>TinyCalc™</p> <p>TinyLogic™</p> <p>TINYOPTO™</p> <p>TinyPower™</p> <p>TinyPWM™</p> <p>TinyWire™</p> <p>TriFault Detect™</p> <p>TRUECURRENT™</p> <p>μSerDes™</p> <p>UHC®</p> <p>Ultra FRFET™</p> <p>UniFET™</p> <p>VCX™</p> <p>VisualMax™</p> <p>XSTM</p> |
| Auto-SPM™                | FRFET®                              | PowerTrench®                          |  |
| Build it Now™            | Global Power Resource <sup>SM</sup> | PowerXSTM™                            |  |
| CorePLUS™                | Green FPS™                          | Programmable Active Droop™            |  |
| CorePOWER™               | Green FPS™ e-Series™                | QFET®                                 |  |
| CROSSVOL™                | Gmax™                               | QSTM™                                 |  |
| CTL™                     | GTO™                                | Quiet Series™                         |  |
| Current Transfer Logic™  | IntelliMAX™                         | RapidConfigure™                       |  |
| DEUXPEED®                | ISOPLANAR™                          | ™                                     |  |
| Dual Cool™               | MegaBuck™                           | Saving our world, 1mW/W/kW at a time™ |  |
| EcoSPARK®                | MICROCOUPLER™                       | SignalWise™                           |  |
| EfficientMax™            | MicroFET™                           | SmartMax™                             |  |
| ESBC™                    | MicroPak™                           | SMART START™                          |  |
| ™                        | MicroPak2™                          | SPM®                                  |  |
| Fairchild®               | MillerDrive™                        | STEALTH™                              |  |
| Fairchild Semiconductor® | MotionMax™                          | SuperFET™                             |  |
| FACT Quiet Series™       | Motion-SPM™                         | SuperSOT™-3                           |  |
| FACT®                    | OptoHIT™                            | SuperSOT™-6                           |  |
| FAST®                    | OPTOLOGIC®                          | SuperSOT™-8                           |  |
| FastvCore™               | OPTOPLANAR®                         | SupreMOS®                             |  |
| FETBench™                | ™                                   | SyncFET™                              |  |
| FlashWriter <sup>®</sup> |                                     | Sync-Lock™                            |  |
| FPS™                     |                                     |                                       |  |

\* Trademarks of System General Corporation, used under license by Fairchild Semiconductor.

**DISCLAIMER**

FAIRCHILD SEMICONDUCTOR RESERVES THE RIGHT TO MAKE CHANGES WITHOUT FURTHER NOTICE TO ANY PRODUCTS HEREIN TO IMPROVE RELIABILITY, FUNCTION, OR DESIGN. FAIRCHILD DOES NOT ASSUME ANY LIABILITY ARISING OUT OF THE APPLICATION OR USE OF ANY PRODUCT OR CIRCUIT DESCRIBED HEREIN; NEITHER DOES IT CONVEY ANY LICENSE UNDER ITS PATENT RIGHTS, NOR THE RIGHTS OF OTHERS. THESE SPECIFICATIONS DO NOT EXPAND THE TERMS OF FAIRCHILD'S WORLDWIDE TERMS AND CONDITIONS, SPECIFICALLY THE WARRANTY THEREIN, WHICH COVERS THESE PRODUCTS.

**LIFE SUPPORT POLICY**

FAIRCHILD'S PRODUCTS ARE NOT AUTHORIZED FOR USE AS CRITICAL COMPONENTS IN LIFE SUPPORT DEVICES OR SYSTEMS WITHOUT THE EXPRESS WRITTEN APPROVAL OF FAIRCHILD SEMICONDUCTOR CORPORATION.

As used herein:

1. Life support devices or systems are devices or systems which, (a) are intended for surgical implant into the body or (b) support or sustain life, and (c) whose failure to perform when properly used in accordance with instructions for use provided in the labeling, can be reasonably expected to result in a significant injury of the user.
2. A critical component in any component of a life support, device, or system whose failure to perform can be reasonably expected to cause the failure of the life support device or system, or to affect its safety or effectiveness.

**ANTI-COUNTERFEITING POLICY**

Fairchild Semiconductor Corporation's Anti-Counterfeiting Policy. Fairchild's Anti-Counterfeiting Policy is also stated on our external website, [www.fairchildsemi.com](http://www.fairchildsemi.com), under Sales Support.

Counterfeiting of semiconductor parts is a growing problem in the industry. All manufacturers of semiconductor products are experiencing counterfeiting of their parts. Customers who inadvertently purchase counterfeit parts experience many problems such as loss of brand reputation, substandard performance, failed applications, and increased cost of production and manufacturing delays. Fairchild is taking strong measures to protect ourselves and our customers from the proliferation of counterfeit parts. Fairchild strongly encourages customers to purchase Fairchild parts either directly from Fairchild or from Authorized Fairchild Distributors who are listed by country on our web page cited above. Products customers buy either from Fairchild directly or from Authorized Fairchild Distributors are genuine parts, have full traceability, meet Fairchild's quality standards for handling and storage and provide access to Fairchild's full range of up-to-date technical and product information. Fairchild and our Authorized Distributors will stand behind all warranties and will appropriately address any warranty issues that may arise. Fairchild will not provide any warranty coverage or other assistance for parts bought from Unauthorized Sources. Fairchild is committed to combat this global problem and encourage our customers to do their part in stopping this practice by buying direct or from authorized distributors.

**PRODUCT STATUS DEFINITIONS**

**Definition of Terms**

Datasheet Identification	Product Status	Definition
Advance Information	Formative / In Design	Datasheet contains the design specifications for product development. Specifications may change in any manner without notice.
Preliminary	First Production	Datasheet contains preliminary data; supplementary data will be published at a later date. Fairchild Semiconductor reserves the right to make changes at any time without notice to improve design.
No Identification Needed	Full Production	Datasheet contains final specifications. Fairchild Semiconductor reserves the right to make changes at any time without notice to improve the design.
Obsolete	Not In Production	Datasheet contains specifications on a product that is discontinued by Fairchild Semiconductor. The datasheet is for reference information only.

Rev. 149

ON Semiconductor and  are trademarks of Semiconductor Components Industries, LLC dba ON Semiconductor or its subsidiaries in the United States and/or other countries. ON Semiconductor owns the rights to a number of patents, trademarks, copyrights, trade secrets, and other intellectual property. A listing of ON Semiconductor's product/patent coverage may be accessed at [www.onsemi.com/site/pdf/Patent-Marking.pdf](http://www.onsemi.com/site/pdf/Patent-Marking.pdf). ON Semiconductor reserves the right to make changes without further notice to any products herein. ON Semiconductor makes no warranty, representation or guarantee regarding the suitability of its products for any particular purpose, nor does ON Semiconductor assume any liability arising out of the application or use of any product or circuit, and specifically disclaims any and all liability, including without limitation special, consequential or incidental damages. Buyer is responsible for its products and applications using ON Semiconductor products, including compliance with all laws, regulations and safety requirements or standards, regardless of any support or applications information provided by ON Semiconductor. "Typical" parameters which may be provided in ON Semiconductor data sheets and/or specifications can and do vary in different applications and actual performance may vary over time. All operating parameters, including "Typicals" must be validated for each customer application by customer's technical experts. ON Semiconductor does not convey any license under its patent rights nor the rights of others. ON Semiconductor products are not designed, intended, or authorized for use as a critical component in life support systems or any FDA Class 3 medical devices or medical devices with a same or similar classification in a foreign jurisdiction or any devices intended for implantation in the human body. Should Buyer purchase or use ON Semiconductor products for any such unintended or unauthorized application, Buyer shall indemnify and hold ON Semiconductor and its officers, employees, subsidiaries, affiliates, and distributors harmless against all claims, costs, damages, and expenses, and reasonable attorney fees arising out of, directly or indirectly, any claim of personal injury or death associated with such unintended or unauthorized use, even if such claim alleges that ON Semiconductor was negligent regarding the design or manufacture of the part. ON Semiconductor is an Equal Opportunity/Affirmative Action Employer. This literature is subject to all applicable copyright laws and is not for resale in any manner.

## PUBLICATION ORDERING INFORMATION

### LITERATURE FULFILLMENT:

Literature Distribution Center for ON Semiconductor  
19521 E. 32nd Pkwy, Aurora, Colorado 80011 USA  
**Phone:** 303-675-2175 or 800-344-3860 Toll Free USA/Canada  
**Fax:** 303-675-2176 or 800-344-3867 Toll Free USA/Canada  
**Email:** [orderlit@onsemi.com](mailto:orderlit@onsemi.com)

**N. American Technical Support:** 800-282-9855 Toll Free  
USA/Canada  
**Europe, Middle East and Africa Technical Support:**  
Phone: 421 33 790 2910  
**Japan Customer Focus Center**  
Phone: 81-3-5817-1050

**ON Semiconductor Website:** [www.onsemi.com](http://www.onsemi.com)  
**Order Literature:** <http://www.onsemi.com/orderlit>  
For additional information, please contact your local  
Sales Representative

## Looking for pricing, stock, or lifecycle information?

Click below to explore more details on WIN SOURCE:

- ⊖ [View SG6961SZ on WIN SOURCE](#)
- ⊖ [Fairchild/ON Semiconductor Information](#)

## Optimize Your Supply Chain with WIN SOURCE Solutions

- ✓ Global Sourcing Solution
- ✓ Obsolete Management
- ✓ Cost Control Management
- ✓ Shortage Management
- ✓ Alternative Solution
- ✓ Excess Inventory Management