



**THE DATASHEET OF
SE5510T-R**



DATA SHEET
SE5510T: Dual Band 802.11n WLAN/BT Front End

Applications

- IEEE802.11b DSSS WLAN
- IEEE802.11a,g,n OFDM WLAN
- Embedded applications with Bluetooth (Mobile)

Features

- All RF ports matched to 50 Ω
- Integrated 2.4,5 GHz PA, 5 GHz LNA, SP3T, SP2T switches and filtering
- Integrated Power Detector
- 19.5 dBm @ 3 % EVM, 802.11g, 54 Mbps
- 18 dBm @ 3 % EVM, 802.11a, 54 Mbps
- Lead free, Halogen Free and RoHS compliant
- Compact package, 3 x 4 x 0.6 mm, MSL 1

Product Description

The SE5510T is a complete 802.11n WLAN RF front-end module providing all the functionality of the power amplifiers, LNA, power detector, Antenna switches, filtering and associated matching. The SE5510T provides a complete 2.4 GHz and 5 GHz WLAN RF solution from the output of the transceiver to the antennas in a compact form factor.

The receive path is designed to maximize performance by providing both a 5 GHz Low noise amplifier with bypass mode, for use when high power signals are being received.

Designed for ease of use, all RF ports are matched to 50 Ω to simplify PCB layout and the interface to the transceiver RFIC. The SE5510T also includes a transmitter power detector for each band with 20 dB of dynamic range.

Ordering Information

Part No.	Package	Remark
SE5510T	28 pin QFN	Samples
SE5510T-R	28 pin QFN	Tape & Reel
SE5510T-EK1	N/A	Evaluation kit

Functional Block Diagram

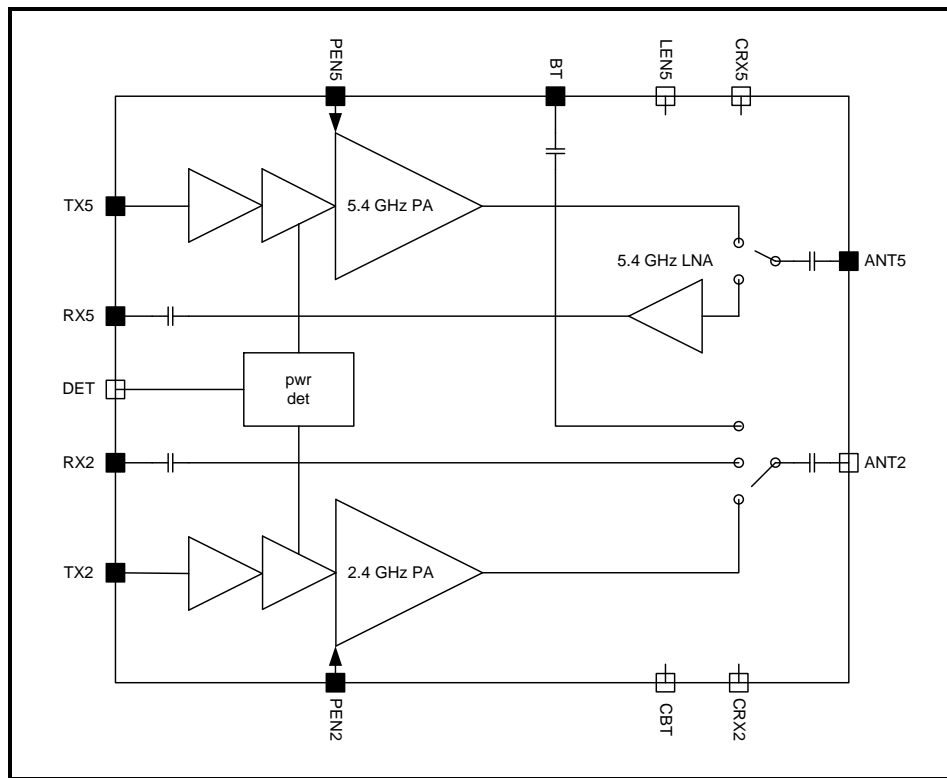

Figure 1: Functional Block Diagram

DATA SHEET
SE5510T: Dual Band 802.11n WLAN/BT Front End

Pin Out Diagram

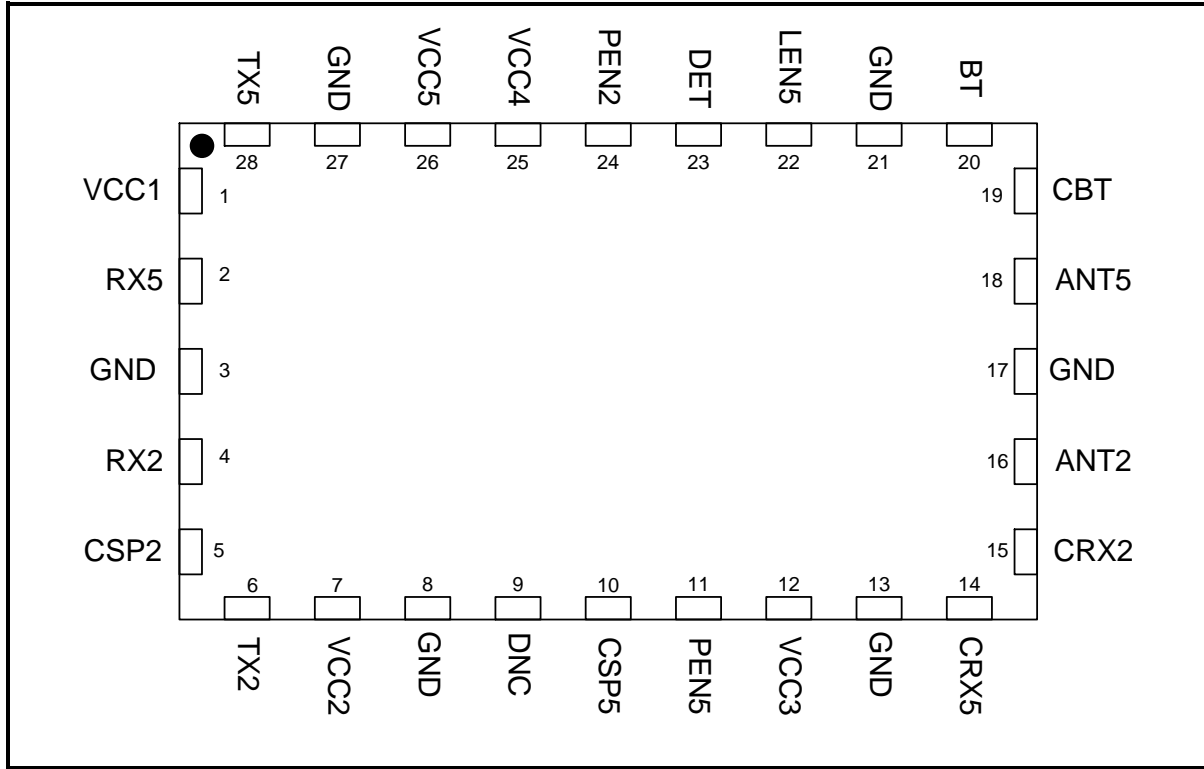

Figure 2: SE5510T Pin Out (Top View Through Package)

Pin Out Description

Pin No.	Name	Description
1	VCC1	Power Supply
2	RX5	5 GHz Receive port
3	GND	Ground
4	RX2	2.4 GHz Receive port
5	CSP2	2.4 GHz PA bias speed-up
6	TX2	2.4 GHz Transmit port
7	VCC2	Power supply
8	GND	Ground
9	DNC	Do Not Connect
10	CSP5	5 GHz PA bias speed-up
11	PEN5	Enable for 5 GHz PA and Transmit switch
12	VCC3	Power supply
13	GND	Ground
14	CRX5	Control for 5 GHz Receive
15	CRX2	Control for 2.4 GHz Receive

Pin No.	Name	Description
16	ANT2	2.4 GHz Antenna port
17	GND	Ground
18	ANT5	5 GHz Antenna port
19	CBT	Control for Bluetooth port
20	BT	Bluetooth port
21	GND	Ground
22	LEN5	Enable for 5 GHz LNA and Receive Switch
23	DET	Power detector output
24	PEN2	Enable for 2.4 GHz PA and Transmit Switch
25	VCC4	Power supply
26	VCC5	Power Supply
27	GND	Ground
28	TX5	5 GHz Transmit port

DATA SHEET
SE5510T: Dual Band 802.11n WLAN/BT Front End

Absolute Maximum Ratings

These are stress ratings only. Exposure to stresses beyond these maximum ratings may cause permanent damage to, or affect the reliability of the device. Avoid operating the device outside the recommended operating conditions defined below. This device is ESD sensitive. Handling and assembly of this device should be at ESD protected workstations.

Symbol	Definition	Min.	Max.	Unit
V _{CC}	Supply Voltage	-0.3	5.5	V
V _{IN}	Control Pin Voltages	-0.3	3.6	V
TX _{RFIN}	TX2/TX5, with ANT2/ANT5 terminated in 50Ω	-	+10	dBm
T _A	Operating Temperature Range	-40	85	°C
T _{STG}	Storage Temperature Range	-40	150	°C
ESD _{HBM}	JEDEC JESD22-A114 All pins		1000	V

Recommended Operating Conditions

Symbol	Parameter	Min.	Typ.	Max.	Unit
V _{CC}	Supply Voltage	2.97	3.3	3.6	V
T _A	Ambient Temperature	-40	25	85	°C

Control Logic Characteristics

Conditions: V_{CC} = 3.3 V, T_A = 25 °C, as measured on Skyworks Solutions' SE5510T-EK1 evaluation board (de-embedded to device), all unused ports terminated with 50 ohms, unless otherwise noted.

Parameter	min	nom	max	Units
Logic input high : V _{IH}	1.6		3.6	V
Logic input low : V _{IL}	0		0.3	V
Logic input High current : I _{IH} (All except CRX2, CRX5) I _{IH} (CRX2, CRX5)			1 50	μA
Logic input Low current : I _{IL} (All except CRX2, CRX5) I _{IL} (CRX2, CRX5)			1 20	μA

DATA SHEET
SE5510T: Dual Band 802.11n WLAN/BT Front End

DC Electrical Characteristics

Conditions: $V_{CC} = 3.3\text{ V}$, $T_A = 25\text{ }^\circ\text{C}$, as measured on Skyworks Solutions' SE5510T-EK1 evaluation board (de-embedded to device), all unused ports terminated with 50 ohms, unless otherwise noted

Symbol	Parameter	Conditions	Min.	Typ.	Max.	Unit
TXI _{CC-G}	Total 802.11g Transmit Supply Current	P _{OUT} = 20 dBm, 54 Mbps OFDM signal, 64QAM, PEN2 = Hi, P _{OUT} = 18 dBm, 54 Mbps OFDM signal, 64QAM, PEN2 = Hi,	-	215 185		mA
TXI _{CQ-G}	Quiescent current , 802.11g Transmit supply Current	No RF applied, PEN2=Hi	-	120	-	mA
TXI _{CC-A}	Total 802.11a Transmit Supply Current	P _{OUT} = 18 dBm, 54 Mbps OFDM signal, 64QAM, PEN5= Hi P _{OUT} = 16 dBm, 54 Mbps OFDM signal, 64QAM, PEN5= Hi	-	230 210		mA
TXI _{CQ-A}	Quiescent current , 802.11a Transmit supply Current	No RF applied, PEN5- Hi	-	155	-	mA
RXI _{CC-A}	Total 802.11a Receive Supply Current	CRX5 = Hi, LEN= Hi CRX5 = Hi, LEN = Lo	-	10 0.25		mA
RXI _{CC-G}	Total 802.11g Receive Supply Current	CRX2 = Hi		0.25		mA
I _{CC-BT}	Total BT Supply Current	CBT = Hi	-	0.25		mA
I _{CC_OFF}	Total Supply Current	No RF, PEN2=PEN5=CRX2=CRX5=CBT=L EN5=0V	-	5		μA

DATA SHEET
SE5510T: Dual Band 802.11n WLAN/BT Front End

Operating Modes

Mode#	Mode Description	PEN2	PEN5	LEN5	CRX2	CRX5	CBT
0	All Off	0	0	0	0	0	0
1	BT	0	0	0	0	0	1
2	BT + RX5(Low gain)	0	0	0	0	1	1
3	BT + RX5(High gain)	0	0	1	0	1	1
4	BT + TX5	0	1	0	0	0	1
5	RX2 + RX5(Low gain)	0	0	0	1	1	0
6	RX2 + RX5(High gain)	0	0	1	1	1	0
7	TX2	1	0	0	0	0	0
8	TX5	0	1	0	0	0	0
9	RX2	0	0	0	1	0	0
10	RX5 (Low Gain)	0	0	0	0	1	0
11	RX5 (High Gain)	0	0	1	0	1	0

DATA SHEET
SE5510T: Dual Band 802.11n WLAN/BT Front End

AC Electrical Characteristics

2.4 GHz Transmit Characteristics

Conditions: $V_{CC} = 3.3\text{ V}$, PEN2= Hi, $T_A = 25\text{ }^\circ\text{C}$, as measured on Skyworks Solutions' SE5510T-EK1 evaluation board (de-embedded to device), all unused ports terminated with 50 ohms, unless otherwise noted.

Symbol	Parameter	Condition	Min.	Typ.	Max.	Unit
F_{IN}	Frequency Range	-	2400	-	2500	MHz
P_{OUT}	Output Power, 54 Mbps OFDM, 64 QAM	EVM=3% EVM=2.5%	18.5	19.5 18		dBm
S_{21}	Gain	2400 – 2500 MHz		27.5		dB
S_{21_OOB}	Out of Band Gain	<2170 MHz			19	dB
ΔS_{21}	Gain Variation	Over band			1.5	dBpp
S_{11}	Input Return Loss			-10		dB
S_{22}	Output Return Loss			-10	-5	dB
NF	Noise Figure			10		dB
2f	11b Harmonics	2f @ Pout= 22 dBm		-35	-25	dBm/MHz
3f		3f @ Pout = 22 dBm		-35	-30	
ACP11b	Spectral Mask	11b @ Pout=22 dBm: fc +/- 11 MHz fc +/- 22 MHz		-34 -54	-32 -52	dBc
STAB	Stability	$P_{OUT} \leq 23\text{ dBm}$ Load VSWR = 4:1	All non-harmonically related outputs less than -45 dBm/MHz			
TEN	Enable time	10% to 90% of TX RF power, from time that PEN2 is at 50%			800	nsec

DATA SHEET
SE5510T: Dual Band 802.11n WLAN/BT Front End

2.4 GHz Receive Characteristics

Conditions: $V_{CC} = 3.3V$, CRX2 = Hi, $T_A = 25\text{ }^\circ\text{C}$, as measured on Skyworks Solutions' SE5510T-EK1 evaluation board (de-embedded to device), all unused ports terminated with 50 ohms, unless otherwise noted.

Symbol	Parameter	Condition	Min.	Typ.	Max.	Unit
F _{OUT}	Frequency Range	-	2400	-	2500	MHz
RX2 _{IL}	Insertion Loss	CRX2= Hi	-	1.0		dB
S ₁₁	RX2 Port Return Loss	CRX2= Hi	-	-14		dB
ISOL _{SW}	Switch Isolation	ANT2-RX2, PEN2=Hi	26		-	dB
IP1dB	Input P1dB	CRX2= Hi	15			dBm
T _{EN}	Enable Time	10% to 90% of RX RF power, from time that CRX2 is at 50%	-	-	800	nsec

Bluetooth Characteristics

Conditions: $V_{CC} = 3.3\text{ V}$, CBT= Hi, $T_A = 25\text{ }^\circ\text{C}$, as measured on Skyworks Solutions' SE5510T-EK1 evaluation board (de-embedded to device), all unused ports terminated with 50 ohms, unless otherwise noted.

Symbol	Parameter	Condition	Min.	Typ.	Max.	Unit
F _{OUT}	Frequency Range	-	2400	-	2500	MHz
BT _{IL}	Insertion Loss	CBT= Hi	-	1.0		dB
S ₁₁	BT Port Return Loss	CBT= Hi	-	-14		dB
ISOL _{SW}	Switch Isolation	ANT2-BT, PEN2=Hi	20	-	-	dB
IP1dB	Input P1dB	CBT= Hi	15			dBm
T _{EN}	Enable Time	10% to 90% of BT RF power, from time that CBT is at 50%	-	-	800	nsec

DATA SHEET
SE5510T: Dual Band 802.11n WLAN/BT Front End

5 GHz Transmit Characteristics

Conditions: VCC = 3.3 V, PEN5= Hi, T_A = 25 °C, as measured on Skyworks Solutions' SE5510T-EK1 evaluation board (de-embedded to device), all unused ports terminated with 50 ohms, unless otherwise noted.

Symbol	Parameter	Condition	Min.	Typ.	Max.	Unit
F _{IN}	Frequency Range	-	4900	-	5850	MHz
P _{OUT}	Output Power, 54 Mbps OFDM, 64 QAM	EVM=3% EVM=2.5%	17.0	18 16		dBm
S ₂₁	Gain			28		dB
ΔS ₂₁	Gain Variation	Over 40 MHz Channel			1.5	dBpp
S ₁₁	Input Return Loss			-14	-10	dB
S ₂₂	Output Return Loss			-10	-5	dB
2f	Harmonics @ Pout=18 dBm	2f (5150-5300 MHz)		-40	-35	dBm/MHz
3f		2f (5300-5850 MHz)		-50	-42	
		3f @ Pout = 18 dBm		-50	-45	
ACP11a	Spectral Mask	11a @ Pout=18 dBm: fc +/- 11 MHz fc +/- 20 MHz fc +/- 30 MHz		-23 -30 -43	-20 -28 -40	dBc
	Stability	P _{OUT} ≤ 21dBm Load VSWR = 4:1	All non-harmonically related outputs less than -45 dBm/MHz			
T _{EN}	Enable time	10% to 90% of TX RF power, from time that PEN5 is at 50%	-	-	800	nsec

5 GHz Receive Characteristics

Conditions: VCC = 3.3 V, LEN5= Hi, T_A = 25 °C, as measured on Skyworks Solutions' SE5510T-EK1 evaluation board (de-embedded to device), all unused ports terminated with 50 ohms, unless otherwise noted.

Symbol	Parameter	Condition	Min.	Typ.	Max.	Unit
F _{OUT}	Frequency Range	-	4900	-	5900	MHz
S ₂₁	Gain	LEN5 = Hi		12		dB
		LEN5 = Lo		-7		dB
NF	Noise Figure	LEN5=Hi	-	2.5		dB
IP1dB	Input P1dB	LEN5= Hi LEN5=Lo	-8 +5	-6 +7	-	dBm
S ₁₁	Input Return Loss	-	-	-10		dB
T _{EN}	Enable Time	10% to 90% of RX RF power, from time that	-	-	800	nsec

DATA SHEET
SE5510T: Dual Band 802.11n WLAN/BT Front End

Symbol	Parameter	Condition	Min.	Typ.	Max.	Unit
		LEN5 is at 50%				

Power Detector Characteristics

Conditions: $V_{CC} = 3.3\text{ V}$, $T_A = 25\text{ }^\circ\text{C}$, as measured on Skyworks Solutions' SE5510T-EK1 evaluation board (de-embedded to device), all unused ports terminated with 50 ohms, unless otherwise noted.

Symbol	Parameter	Condition	Min.	Typ.	Max.	Unit
F _{OUT}	Frequency Range	PEN2= Hi PEN5 = Hi	2400 4900	-	2500 5900	MHz
PDR	Power detect range, peak power	Measured at ANT	0	-	23	dBm
PDZ _{LOAD}	DC load impedance	-	-	2.5		kΩ
PDV _{P23}	Output Voltage, P _{OUT} = 23 dBm	PEN2= Hi	0.8		1.0	V
PDV _{P19}	Output Voltage, P _{OUT} = 19 dBm	PEN5= Hi 4950 MHz 5150-5850 MHz	0.4 0.5		0.8 1.0	V
PDV _{pnoRF}	Output Voltage, P _{OUT} = No RF	-	-	0.125	-	V
PD _{VAR}	Power Detector Accuracy vs Load VSWR	P _{out} =20 dBm, 2:1 load VSWR, any angle	-1		+0.6	dB

DATA SHEET
SE5510T: Dual Band 802.11n WLAN/BT Front End

Package Diagram

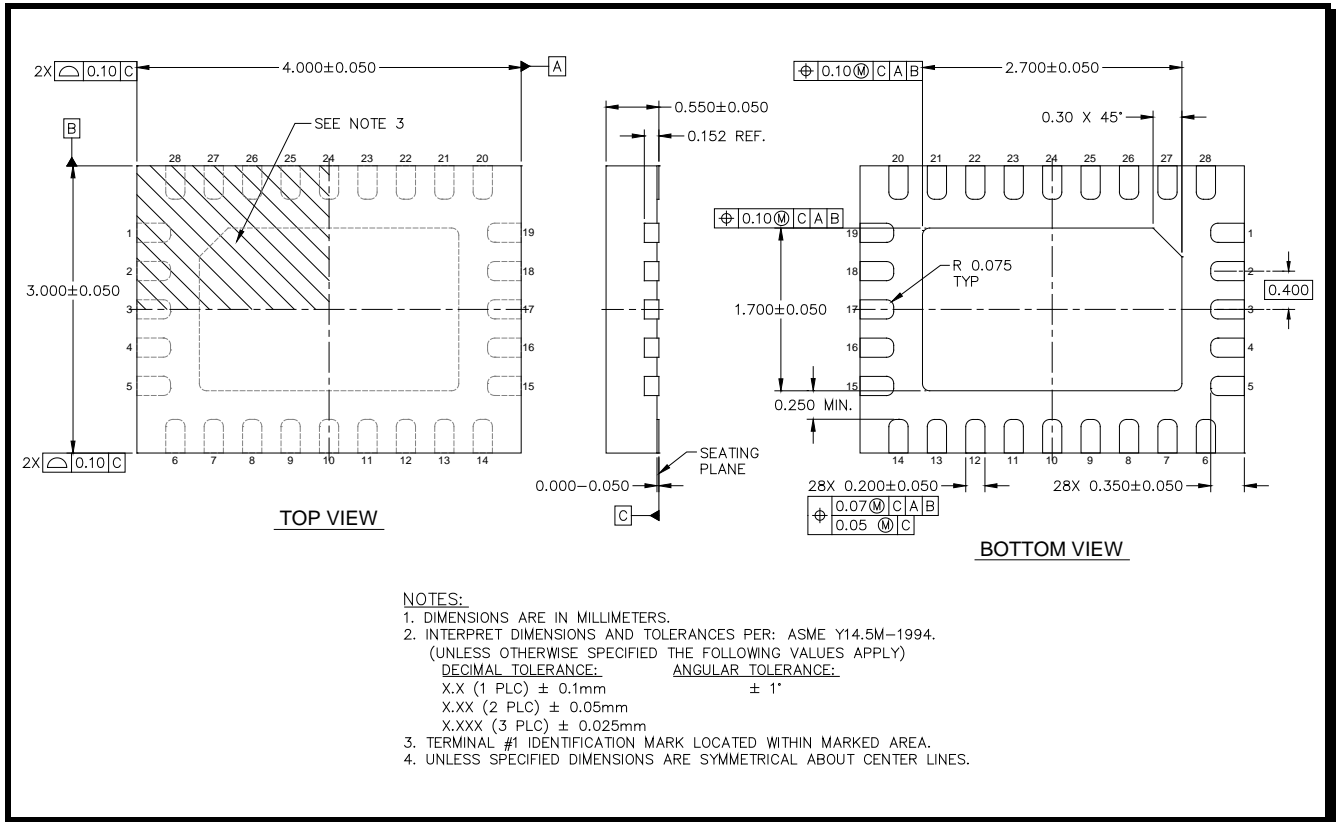

Figure 3: Package Outline Drawing

Branding Information

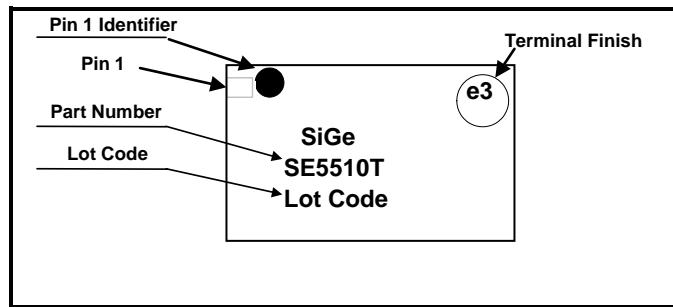

Figure 4: SE5510T Branding Information

DATA SHEET
SE5510T: Dual Band 802.11n WLAN/BT Front End

Recommended PCB Footprint

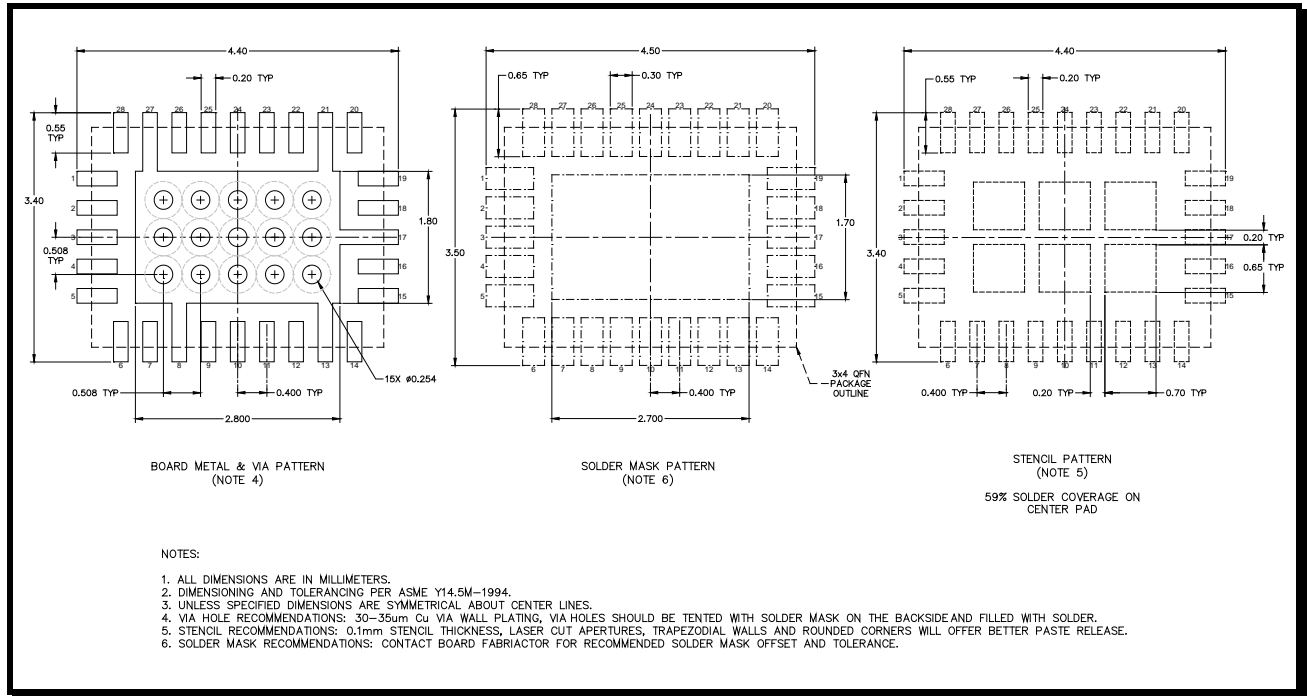

Figure 5: Recommended pcb footprint

Package Handling Information

Because of its sensitivity to moisture absorption, instructions on the shipping container label must be followed regarding exposure to moisture after the container seal is broken, otherwise, problems related to moisture absorption may occur when the part is subjected to high temperature during solder assembly. The SE5510T is capable of withstanding a Pb free solder reflow. Care must be taken when attaching this product, whether it is done manually or in a production solder reflow environment. If the part is manually attached, precaution should be taken to insure that the device is not subjected to temperatures above its rated peak temperature for an extended period of time. For details on both attachment techniques, precautions, and handling procedures recommended, please refer to:

- “Quad Flat No-Lead Module Solder Reflow & Rework Information”, *Document Number QAD-00045*.
- “Handling, Packing, Shipping and Use of Moisture Sensitive QFN”, *Document Number QAD-00044*.

DATA SHEET
SE5510T: Dual Band 802.11n WLAN/BT Front End

Tape and Reel Information

Parameter	Value
Devices Per Reel	3000
Reel Diameter	13 inches
Tape Width	12 millimeters

Figure 6: SE5510T-R Tape and Reel Information

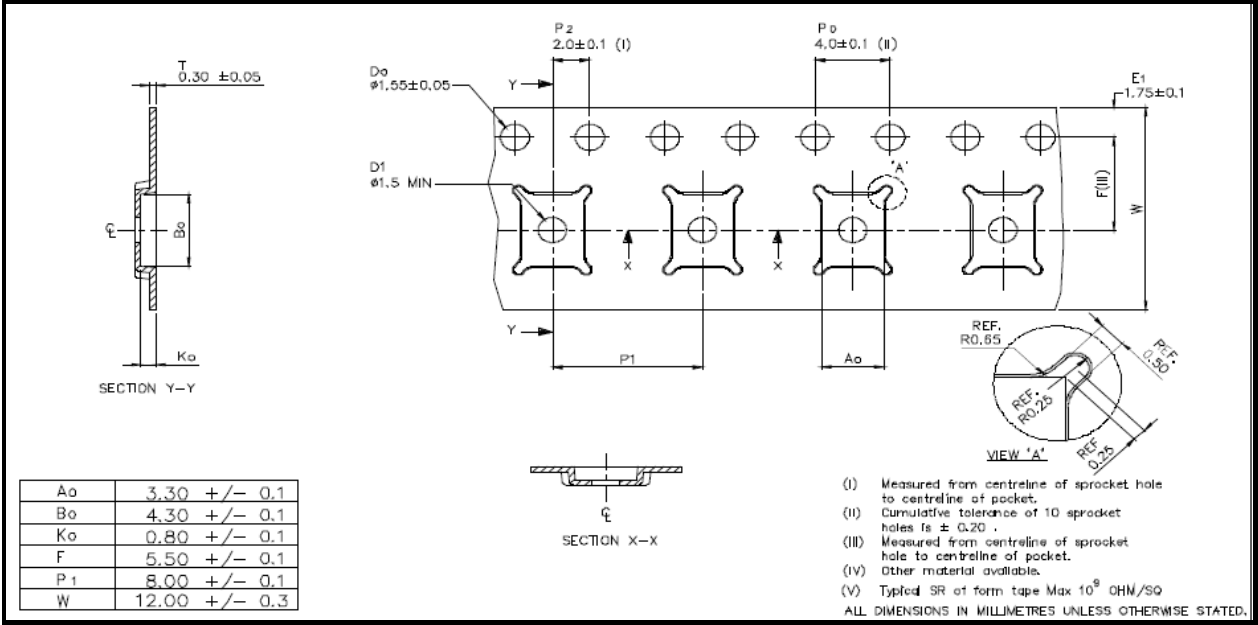

DATA SHEET
SE5510T: Dual Band 802.11n WLAN/BT Front End

Document Change History

Revision	Date	Notes
1.0	April-01-2010	Created
1.1	April-05-2010	Added PCB footprint recommendations
1.2	June-14-2010	Updated Pin out and technical specifications
1.3	June-17-2010	Corrected typo on front page, added pin numbers to Fig2
1.4	June-09-2011	Updated specifications and Updated Functional block diagram
1.5	July-06-2011	Updated RX2 isolation specification
1.6	November-21-2011	Updated specifications
1.7	February-03-2012	Updated temperature range, updated tape and reel info
1.8	April-10-2012	Updated with Skyworks logo and disclaimer statement

Copyright © 2012 Skyworks Solutions, Inc. All Rights Reserved.

Information in this document is provided in connection with Skyworks Solutions, Inc. ("Skyworks") products or services. These materials, including the information contained herein, are provided by Skyworks as a service to its customers and may be used for informational purposes only by the customer. Skyworks assumes no responsibility for errors or omissions in these materials or the information contained herein. Skyworks may change its documentation, products, services, specifications or product descriptions at any time, without notice. Skyworks makes no commitment to update the materials or information and shall have no responsibility whatsoever for conflicts, incompatibilities, or other difficulties arising from any future changes.

No license, whether express, implied, by estoppel or otherwise, is granted to any intellectual property rights by this document. Skyworks assumes no liability for any materials, products or information provided hereunder, including the sale, distribution, reproduction or use of Skyworks products, information or materials, except as may be provided in Skyworks Terms and Conditions of Sale.

THE MATERIALS, PRODUCTS AND INFORMATION ARE PROVIDED "AS IS" WITHOUT WARRANTY OF ANY KIND, WHETHER EXPRESS, IMPLIED, STATUTORY, OR OTHERWISE, INCLUDING FITNESS FOR A PARTICULAR PURPOSE OR USE, MERCHANTABILITY, PERFORMANCE, QUALITY OR NON-INFRINGEMENT OF ANY INTELLECTUAL PROPERTY RIGHT; ALL SUCH WARRANTIES ARE HEREBY EXPRESSLY DISCLAIMED. SKYWORKS DOES NOT WARRANT THE ACCURACY OR COMPLETENESS OF THE INFORMATION, TEXT, GRAPHICS OR OTHER ITEMS CONTAINED WITHIN THESE MATERIALS. SKYWORKS SHALL NOT BE LIABLE FOR ANY DAMAGES, INCLUDING BUT NOT LIMITED TO ANY SPECIAL, INDIRECT, INCIDENTAL, STATUTORY, OR CONSEQUENTIAL DAMAGES, INCLUDING WITHOUT LIMITATION, LOST REVENUES OR LOST PROFITS THAT MAY RESULT FROM THE USE OF THE MATERIALS OR INFORMATION, WHETHER OR NOT THE RECIPIENT OF MATERIALS HAS BEEN ADVISED OF THE POSSIBILITY OF SUCH DAMAGE.



Skyworks products are not intended for use in medical, lifesaving or life-sustaining applications, or other equipment in which the failure of the Skyworks products could lead to personal injury, death, physical or environmental damage. Skyworks customers using or selling Skyworks products for use in such applications do so at their own risk and agree to fully indemnify Skyworks for any damages resulting from such improper use or sale.

Customers are responsible for their products and applications using Skyworks products, which may deviate from published specifications as a result of design defects, errors, or operation of products outside of published parameters or design specifications. Customers should include design and operating safeguards to minimize these and other risks. Skyworks assumes no liability for applications assistance, customer product design, or damage to any equipment resulting from the use of Skyworks products outside of stated published specifications or parameters.

Skyworks, the Skyworks symbol, and "Breakthrough Simplicity" are trademarks or registered trademarks of Skyworks Solutions, Inc., in the United States and other countries. Third-party brands and names are for identification purposes only, and are the property of their respective owners. Additional information, including relevant terms and conditions, posted at www.skyworksinc.com, are incorporated by reference.

Looking for pricing, stock, or lifecycle information?

Click below to explore more details on WIN SOURCE:

-  [View SE5510T-R on WIN SOURCE](#)
-  [Skyworks Solutions Inc. Information](#)

Optimize Your Supply Chain with WIN SOURCE Solutions

-  Global Sourcing Solution
-  Obsolete Management
-  Cost Control Management
-  Shortage Management
-  Alternative Solution
-  Excess Inventory Management