



**THE DATASHEET OF
SBW-5089Z**





Product Description

The SBW-5089(Z) is a high performance InGaP/GaAs HBT MMIC Amplifier. A Darlington circuit fabricated with InGaP process technology provides broadband RF performance up to 8GHz and excellent thermal performance. The heterojunction increases breakdown voltage and minimizes leakage current between junctions. Cancellation of emitter junction non-linearities results in high suppression of intermodulation products. Operation requires only a single positive voltage supply, 2 DC-blocking capacitors, a bias resistor and an RF choke.

Features

- Available in RoHS Compliant and Pb-Free (Z Part Number)
- 50Ω Cascadable Gain Block
- Wideband Flat Gain to 3GHz: +/-1.4dB
- P_{1dB} = 13.4 at 6GHz
- Input / Output VSWR < 2:3 to 8GHz
- Patented Thermal Design
- Single Voltage Supply Operation

Applications

- Wideband Instrumentation
- Fiber Optic Driver
- OC-48
- Basestation
- SAT COM

Gain Return Loss versus Frequency, I_D = 80mA (Typ), Tuned Application Circuit

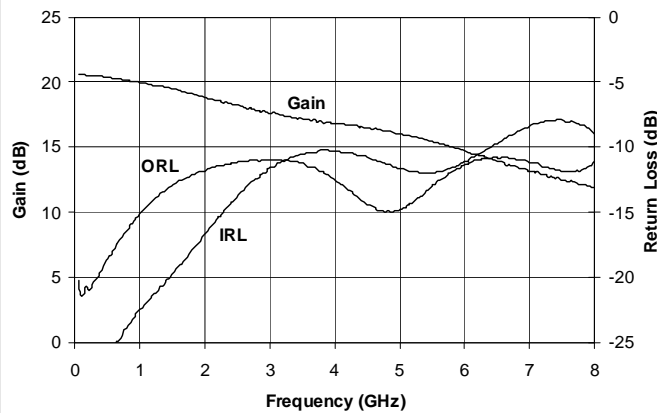

Optimum Technology Matching® Applied

- GaAs HBT
- GaAs MESFET
- InGaP HBT
- SiGe BiCMOS
- Si BiCMOS
- SiGe HBT
- GaAs pHEMT
- Si CMOS
- Si BJT
- GaN HEMT
- InP HBT
- RF MEMS
- LDMOS

| Parameter | Specification | | | Unit | Condition |
|--|---------------|------|------|------|--|
| | Min. | Typ. | Max. | | |
| Small Signal Gain, PC board and connector losses de-embedded | 19.3 | 20.3 | 21.3 | dB | 850MHz |
| | 16.7 | 17.5 | 19.0 | dB | 3000MHz |
| | | 17.2 | | dB | 4200MHz |
| | 14.2 | 15.0 | 16.5 | dB | 6000MHz |
| Output Power at 1dB Compression | | 20.1 | | dBm | 850MHz |
| | 18.4 | 19.4 | | dBm | 1950MHz |
| Output Third Order Intercept Point | | 35.5 | | dBm | 850MHz |
| | 32.0 | 34.0 | | dBm | 1950MHz |
| Output Power | | 13.0 | | dBm | 1950MHz, -45dBc ACP IS-95 9 Forward Channels (P _{OUT}) |
| Determined by Return Loss | | 6000 | | MHz | >10dB |
| Noise Figure | | 3.9 | 4.4 | dB | 1950MHz |
| Worst case Input Return Loss | 7.0 | 10.0 | | dB | DC to 6000MHz |
| Worst case Output Return Loss | 8.0 | 10.0 | | dB | DC to 6000MHz |
| Device Operating Voltage | 4.5 | 4.9 | 5.3 | V | |
| Device Operating Current | 72.0 | 80.0 | 88.0 | mA | |
| Thermal Resistance | | 70 | | °C/W | junction to backside |

Test Conditions: V_S = 8V I_D = 80mA Typ. OIP₃ Tone Spacing = 1MHz T_L = 25°C
 Bias Resistance = 39Ω P_{OUT} per tone = 0dBm Z_S = Z_L = 50Ω

Absolute Maximum Ratings

| Parameter | Rating | Unit |
|---------------------------------------|-------------|-------|
| Max Device Current (I_D) | 130 | mA |
| Max Device Voltage (V_D) | 6 | V |
| Max RF Input Power | 17 | dBm |
| Max Dissipated Power | 0.65 | W |
| Max Junction Temperature (T_J) | 150 | °C |
| Operating Temperature Range (T_L) | -40 to + 85 | °C |
| Max Storage Temperature | 150 | °C |
| ESD Rating - Human Body Model | 1C | Class |
| Moisture Sensitivity Level | MSL 2 | |



Caution! ESD sensitive device.

Exceeding any one or a combination of the Absolute Maximum Rating conditions may cause permanent damage to the device. Extended application of Absolute Maximum Rating conditions to the device may reduce device reliability. Specified typical performance or functional operation of the device under Absolute Maximum Rating conditions is not implied.

RoHS status based on EU Directive 2002/95/EC (at time of this document revision).

The information in this publication is believed to be accurate and reliable. However, no responsibility is assumed by RF Micro Devices, Inc. ("RFMD") for its use, nor for any infringement of patents, or other rights of third parties, resulting from its use. No license is granted by implication or otherwise under any patent or patent rights of RFMD. RFMD reserves the right to change component circuitry, recommended application circuitry and specifications at any time without prior notice.

Typical Performance at Key Operating Frequencies

| Parameter | Units | 500MHz | 850MHz | 1950MHz | 2400MHz | 3500MHz | 5800MHz |
|------------------------------------|-------|--------|--------|---------|---------|---------|---------|
| Small Signal Gain | dB | 20.5 | 20.3 | 19.1 | 18.7 | 17.3 | 15.1 |
| Output Third Order Intercept Point | dBm | 36.5 | 35.5 | 34.0 | 33.0 | 30.5 | 25.5 |
| Output Power at 1dB Compression | dBm | 20.2 | 20.1 | 19.4 | 19.4 | 17.5 | 13.4 |
| Input Return Loss | dB | 26 | 26 | 19 | 15 | 12 | 12.5 |
| Output Return Loss | dB | 19 | 17.5 | 12 | 11 | 10.5 | 10.9 |
| Reverse Isolation | dB | 22 | 23 | 23 | 23 | 23 | 23 |
| Noise Figure | dB | 3.6 | 3.6 | 3.9 | 3.9 | 4.1 | 4.3 |

Test Conditions: $V_S = 8V$, $I_D = 80mA$ Typ, OIP_3 Tone Spacing = 1 MHz, P_{OUT} per tone = 0 dBm, $T_L = 25^\circ C$, Bias Resistance = 39Ω, $Z_S = Z_L = 50\Omega$.

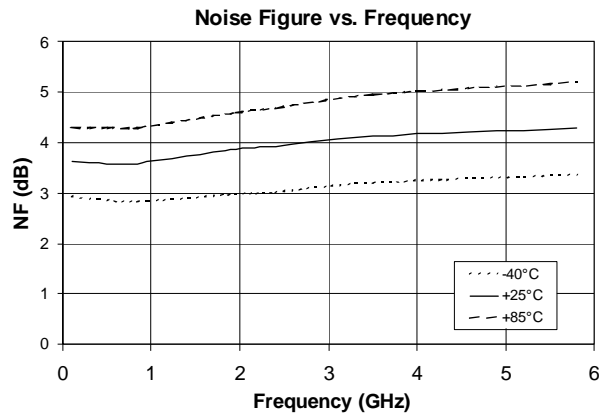
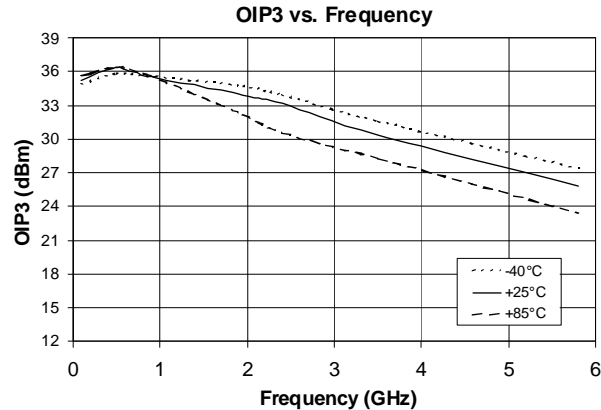
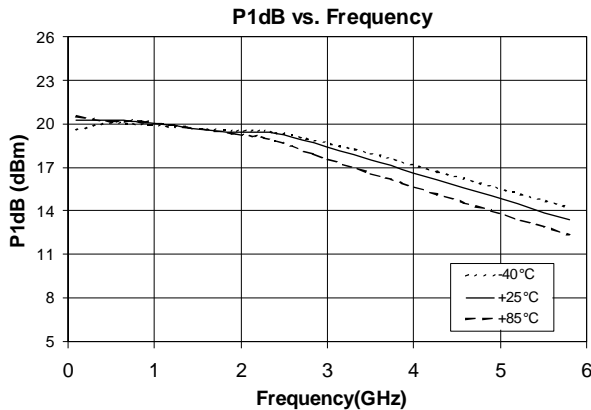

RF Performance With Basic Application Circuit (Bias: $I_D = 80\text{ mA Typ.}$)

S_{21} vs. Frequency

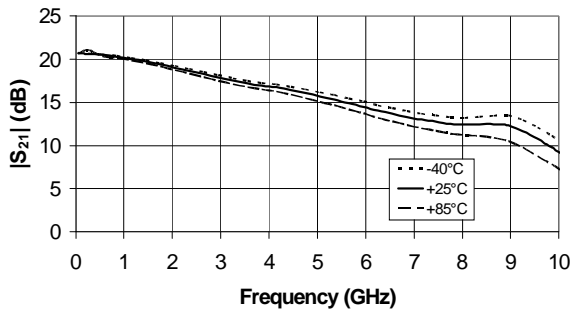

S_{11} vs. Frequency

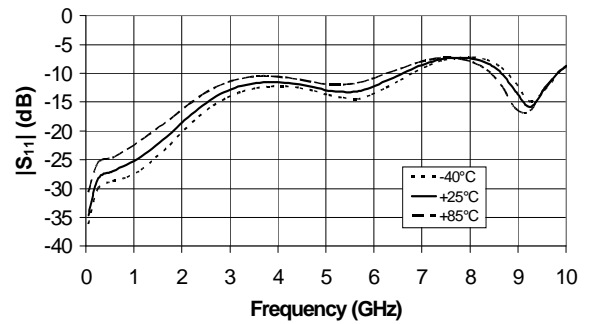

S_{12} vs. Frequency

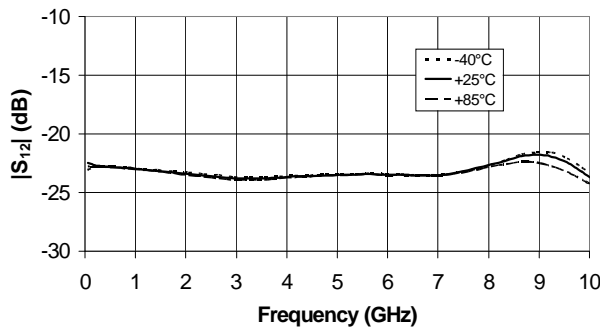

S_{22} vs. Frequency

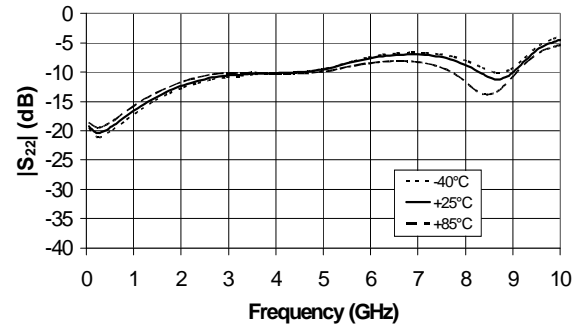

IS-95 @ 850MHz
Adj. Channel Pwr. vs. Channel output Pwr.

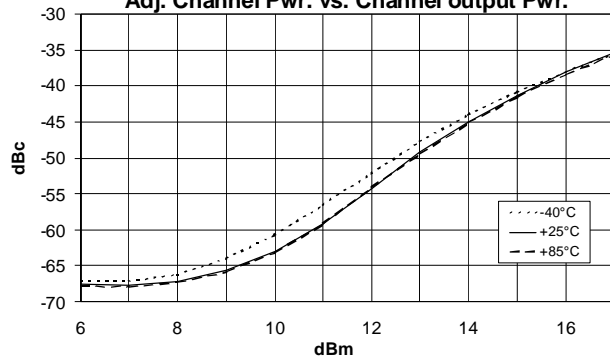

IS-95 @ 1950MHz
Adj. Channel Pwr. vs. Channel Output Power

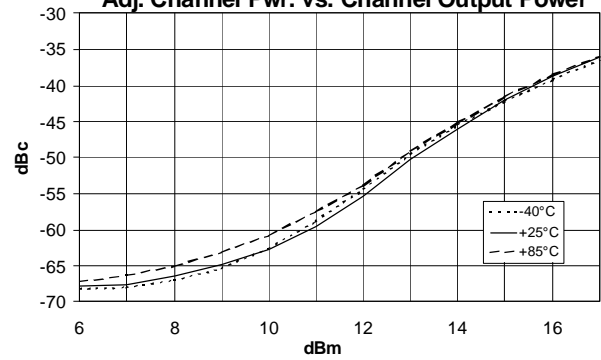

Note: Full S-Parameter data available at www.RFMD.com

SBW-5089(Z)



RFMD + TriQuint = Qorvo

Typical RF Performance With Tuned Application Circuit (Bias: $I_D=80\text{mA}$ Typ.)

S_{21} vs. Frequency

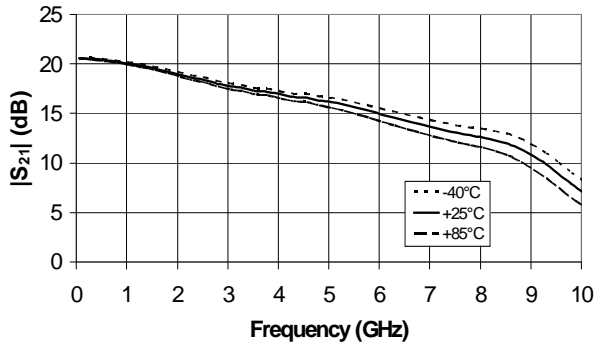

S_{11} vs. Frequency

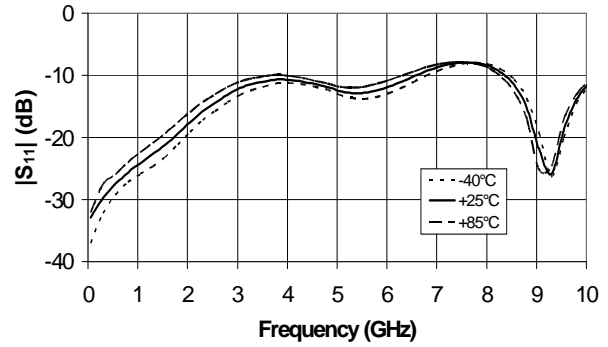

S_{12} vs. Frequency

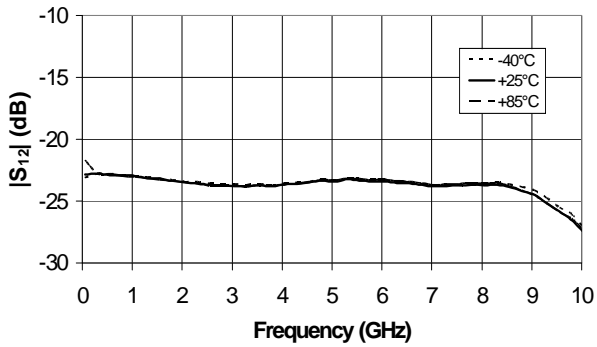

S_{22} vs. Frequency

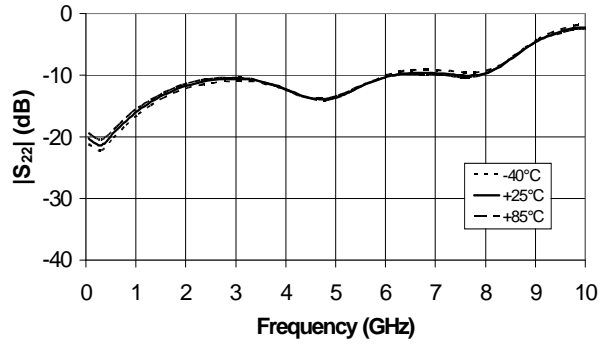

Application Circuit Schematic

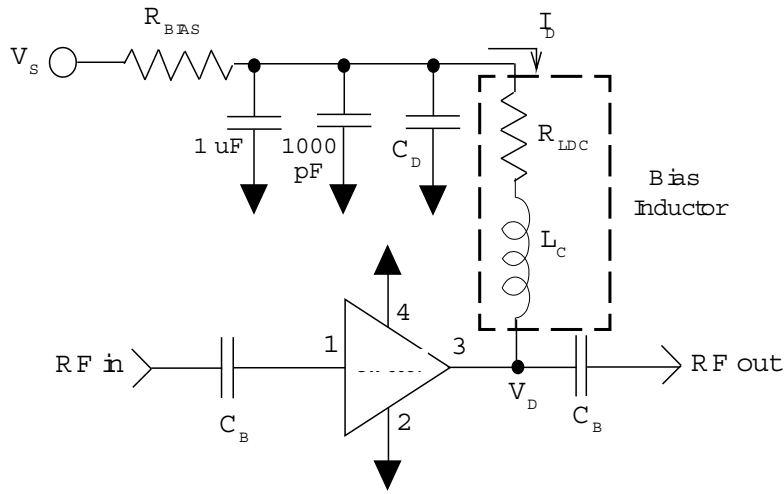

Application Circuit Layout

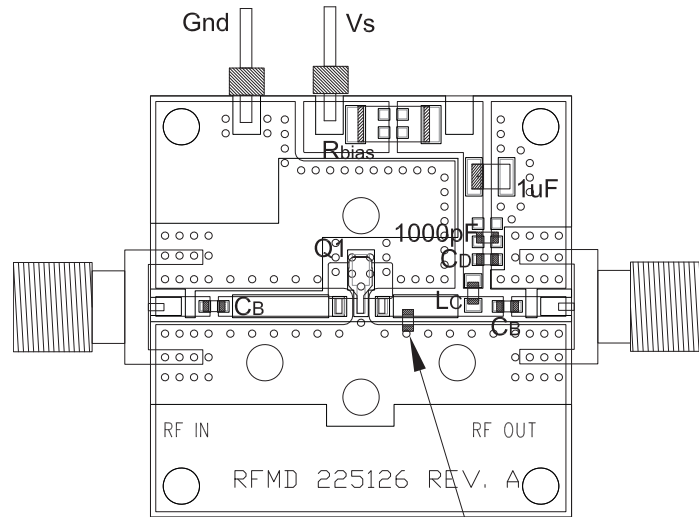

Optional 0.1pF cap placement for better 6GHz output return loss

Application Circuit Element Values

| Reference Designator | 100MHz | 500MHz | 850MHz | 1950MHz | 2400MHz | 3500MHz |
|----------------------|---------|--------|--------|---------|---------|---------|
| C _B | 1000 pF | 220 pF | 100 pF | 68 pF | 56 pF | 39 pF |
| C _D | 100 pF | 100 pF | 68 pF | 22 pF | 22 pF | 15 pF |
| L _C | 470 nH | 68 nH | 33 nH | 22 nH | 18 nH | 15 nH |

Recommended Bias Resistance for I_D=80mA

| Supply Voltage (V _S) (Volts) | <7 | 7 | 7.5 | 8 | 9 | 10 | 12 |
|--|-----|----|-----|----|----|----|----|
| Bias Resistance* (Ω) | N/R | 26 | 33 | 39 | 52 | 64 | 89 |

*Bias Resistance = $R_{BIAS} + R_{LDC} = (V_S - V_D) / I_D$

Select R_{BIAS} so that $R_{BIAS} + R_{LDC} \sim$ the recommended bias resistance. Use 1% or 5% tolerance resistors or parallel combinations to attain the recommended bias resistance $\pm 3\%$. R_{BIAS} provides current stability over temperature.

*N/R=Not recommended. Contact RFMD technical support for guidance when available supply voltage is <7V.

| Pin | Function | Description |
|------|----------------|---|
| 1 | RF IN | RF input pin. This pin requires the use of an external DC-blocking capacitor chosen for the frequency of operation. |
| 2, 4 | GND | Connection to ground. Provide via holes as close to the device ground leads as possible to reduce ground inductance and achieve RF performance. |
| 3 | RF OUT/DC BIAS | RF output and bias pin. This pin requires the use of an external DC-blocking capacitor chosen for the frequency of operation. |

Suggested Pad Layout

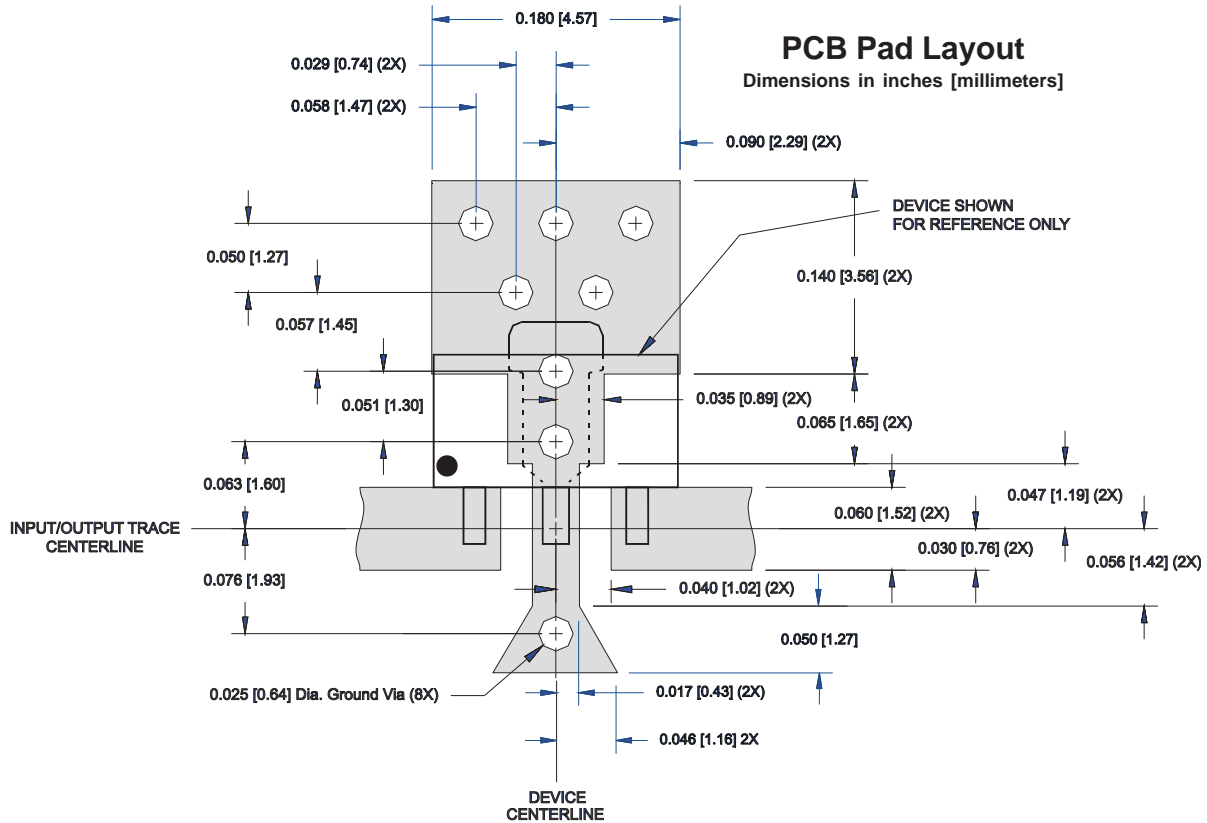

Notes:

1. Solder the copper pad on the backside of the device package to the ground plane.
2. Provide a large ground pad area under device pins 1, 2, 4, and 5 with many plated via holes as shown.
3. Dimensions given for 50Ω I/O lines are for 31mil thick Getek. Scale accordingly for different board thicknesses and dielectric contacts.
4. We recommend 1 or 2 ounce copper. Measurements for this data sheet were made on a 31mil thick Getek with 1 ounce copper on both sides.

Package Drawing

Dimensions in inches (millimeters)

Refer to drawing posted at www.rfmd.com for tolerances.

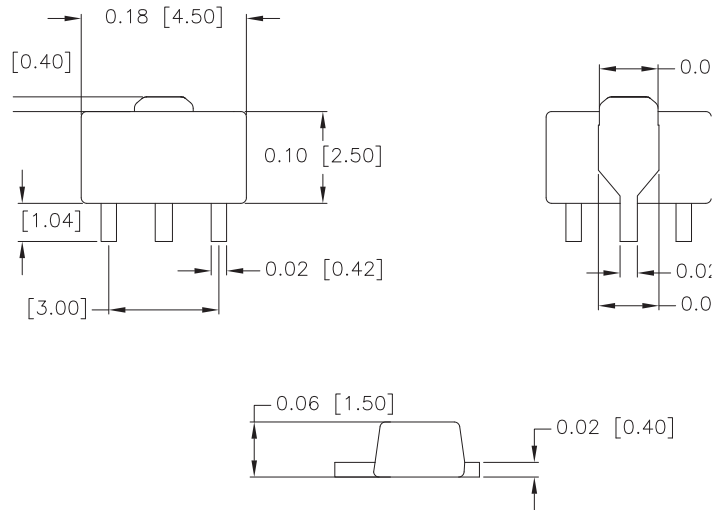

Part Identification Marking

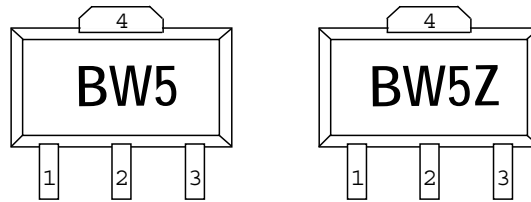

Alternate marking "SBW5089" or "SBW5089Z" on line one with Trace Code on line two.

Ordering Information

| Part Number | Description | Reel Size | Devices/Reel |
|-------------|---------------------------|-----------|--------------|
| SBW-5089 | Tin-Lead | 7" | 1000 |
| SBW-5089Z | Lead Free, RoHS Compliant | 7" | 1000 |

Looking for pricing, stock, or lifecycle information?

Click below to explore more details on WIN SOURCE:

-  [View SBW-5089Z on WIN SOURCE](#)
-  [RF Micro Devices Information](#)

Optimize Your Supply Chain with WIN SOURCE Solutions

-  Global Sourcing Solution
-  Obsolete Management
-  Cost Control Management
-  Shortage Management
-  Alternative Solution
-  Excess Inventory Management