

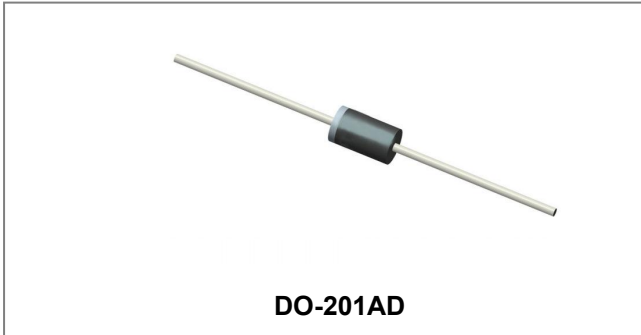

## SB340 SCHOTTKY RECTIFIER



### Features

- Schottky Barrier Chip
- Guard Ring Die Construction for Transient Protection
- High Current Capability
- Low Power Loss, High Efficiency
- High Surge Current Capability
- For Use in Low Voltage, High Frequency Inverters, Free Wheeling, and Polarity Protection Applications
- This is a Pb – Free Device
- All SMC parts are traceable to the wafer lot
- Additional testing can be offered upon request

### Circuit Diagram



### Applications

- Switching power supply
- Converters
- Free-Wheeling diodes
- Reverse battery protection
- Disk drives
- Battery charging

### Maximum Ratings:

Characteristics	Symbol	Condition	Max.	Units
Peak Repetitive Reverse Voltage Working Peak Reverse Voltage DC Blocking Voltage	$V_{RRM}$ $V_{RWM}$ $V_R$	-	40	V
Average Rectified Forward Current	$I_{F(AV)}$	50% duty cycle @ $T_C=105^\circ\text{C}$ , rectangular wave form	3	A
Peak Repetitive Forward Current	$I_{FRM}$	At Rated $V_R$ , Square Wave, 20KHZ, $T_C=80^\circ\text{C}$	10	A
Peak One Cycle Non-Repetitive Surge Current	$I_{FSM}$	8.3 ms, half Sine pulse, $T_C=25^\circ\text{C}$	80	A

### Electrical Characteristics:

Characteristics	Symbol	Condition	Typ.	Max.	Units
Forward Voltage Drop*	$V_{F1}$	@ 3A, Pulse, $T_J = 25^\circ\text{C}$	0.47	0.52	V
	$V_{F2}$	@ 3A, Pulse, $T_J = 125^\circ\text{C}$	0.42	0.47	V
Reverse Current*	$I_{R1}$	@ $V_R = \text{Rated } V_R$ , Pulse, $T_J = 25^\circ\text{C}$	0.05	1.0	mA
	$I_{R2}$	@ $V_R = \text{Rated } V_R$ , Pulse, $T_J = 125^\circ\text{C}$	9	30	mA
Junction Capacitance	$C_T$	@ $V_R = 5\text{V}$ , $T_C = 25^\circ\text{C}$ $f_{SIG} = 1\text{MHz}$	120	200	pF

\* Pulse width < 300  $\mu\text{s}$ , duty cycle < 2%

**Thermal-Mechanical Specifications:**

Characteristics	Symbol	Condition	Specification	Units
Junction Temperature	$T_J$	-	-55 to +125	$^{\circ}\text{C}$
Storage Temperature	$T_{\text{stg}}$	-	-55 to +125	$^{\circ}\text{C}$
Typical Thermal Resistance Junction to Ambient	$R_{\theta JA}$	DC operation	111	$^{\circ}\text{C/W}$
Typical Thermal Resistance Junction to Lead	$R_{\theta JL}$	DC operation	12	$^{\circ}\text{C/W}$
Approximate Weight	wt	-	1.02	g

**Ratings and Characteristics Curves**

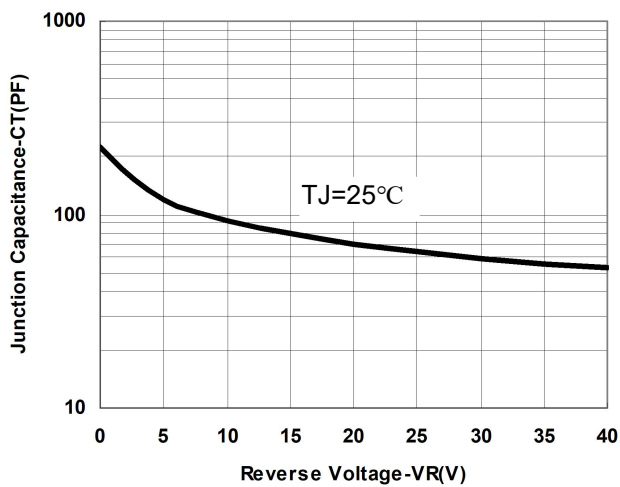

Fig.1-Typical Junction Capacitance

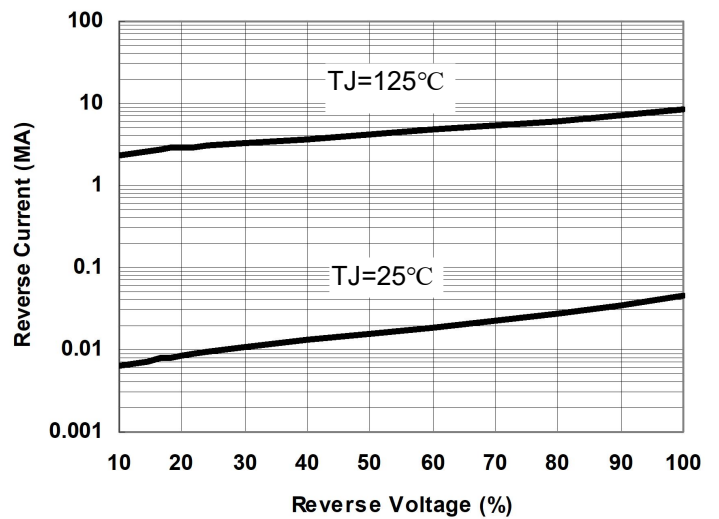

Fig.2-Typical Reverse Current

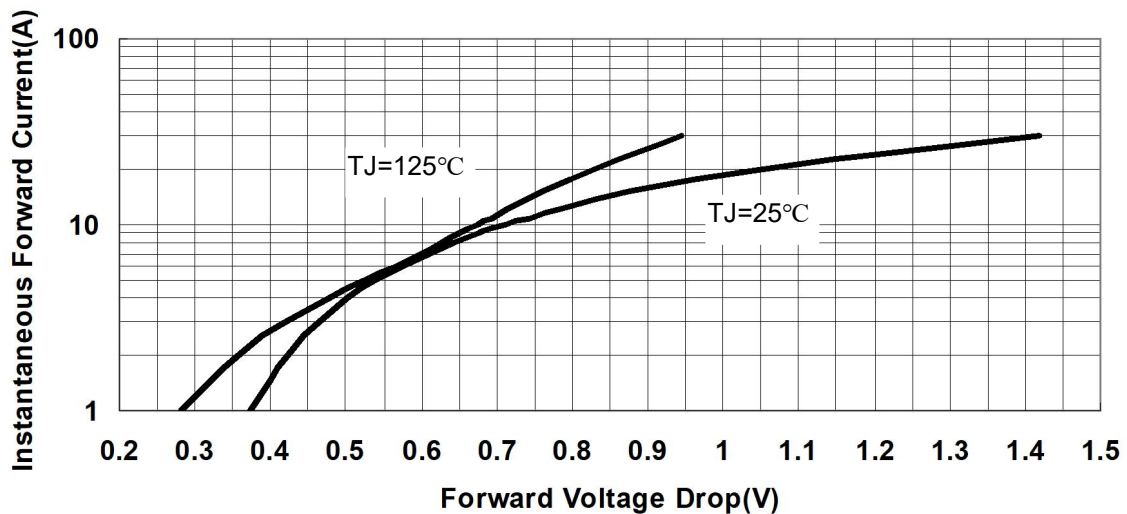
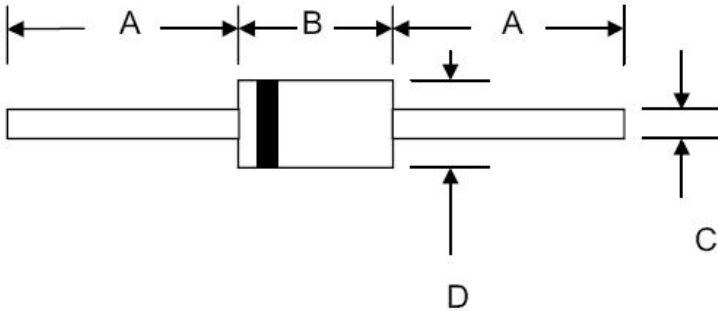

Fig.3-Typical Forward Voltage Drop Characteristics

**Mechanical Dimensions DO-201AD**

SYMBOL	Millimeters		Inches	
	Min.	Max.	Min.	Max.
A	25.4	-	1.000	-
B	8.50	9.50	0.335	0.374
C	1.2	1.3	0.048	0.052
D	5.0	5.6	0.197	0.220

**Ordering Information**

Device	Package	Shipping
SB340	DO-201AD(Pb-Free)	1250pcs / tape
SB340TA	DO-201AD(Pb-Free)	1250pcs / tape

For information on tape and reel specifications, including part orientation and tape sizes, please refer to our tape and reel packaging specification.

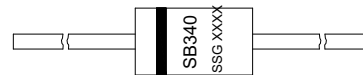
**Marking Diagram**

Where XXXXX is YYWWL

SB340 = Part Name  
SSG = SSG  
YY = Year  
WW = Week  
L = Lot Number

Cautions: Molding resin  
Epoxy resin UL:94V-0

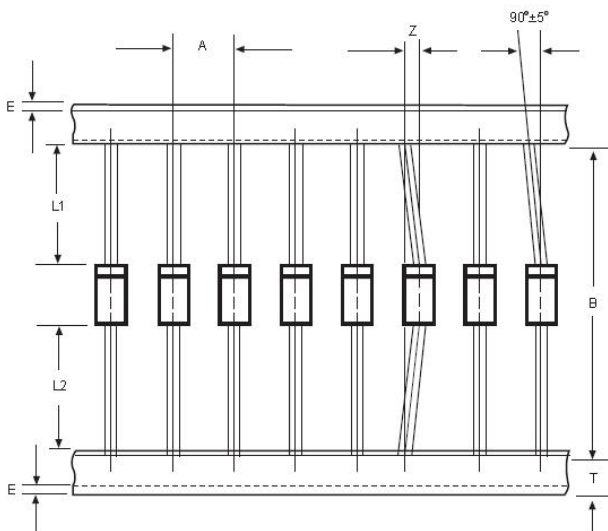
**Carrier Tape Specification DO-201AD**



SYMBOL	Millimeters	
	Min.	Max.
A	9.50	10.50
B	50.9	53.9
Z	-	1.20
T	5.60	6.40
E	-	0.80
IL1-L2I	-	1.0

**DISCLAIMER:**

- 1- The information given herein, including the specifications and dimensions, is subject to change without prior notice to improve product characteristics. Before ordering, purchasers are advised to contact the SMC Diode Solutions sales department for the latest version of the datasheet(s).
- 2- In cases where extremely high reliability is required (such as use in nuclear power control, aerospace and aviation, traffic equipment, medical equipment, and safety equipment), safety should be ensured by using semiconductor devices that feature assured safety or by means of users' fail-safe precautions or other arrangement.
- 3- In no event shall SMC Diode Solutions be liable for any damages that may result from an accident or any other cause during operation of the user's units according to the datasheet(s). SMC Diode Solution assumes no responsibility for any intellectual property claims or any other problems that may result from applications of information, products or circuits described in the datasheets.
- 4- In no event shall SMC Diode Solutions be liable for any failure in a semiconductor device or any secondary damage resulting from use at a value exceeding the absolute maximum rating.
- 5- No license is granted by the datasheet(s) under any patents or other rights of any third party or SMC Diode Solutions.
- 6- The datasheet(s) may not be reproduced or duplicated, in any form, in whole or part, without the expressed written permission of SMC Diode Solutions.
- 7- The products (technologies) described in the datasheet(s) are not to be provided to any party whose purpose in their application will hinder maintenance of international peace and safety nor are they to be applied to that purpose by their direct purchasers or any third party. When exporting these products (technologies), the necessary procedures are to be taken in accordance with related laws and regulations..

## Looking for pricing, stock, or lifecycle information?

Click below to explore more details on WIN SOURCE:

-  [View SB340 on WIN SOURCE](#)
-  [SMC Diode Solutions Information](#)

## Optimize Your Supply Chain with WIN SOURCE Solutions

-  Global Sourcing Solution
-  Obsolete Management
-  Cost Control Management
-  Shortage Management
-  Alternative Solution
-  Excess Inventory Management