



**THE DATASHEET OF
7101TV41LE**



C&K 7000 Series Miniature Toggle Switches

Features/Benefits

- Multi-pole and multi-position
- Wide variety of actuator and termination options
- Epoxy sealed terminals prevent contamination during soldering

Typical Applications

- Telecommunications
- Instrumentation
- Medical equipment

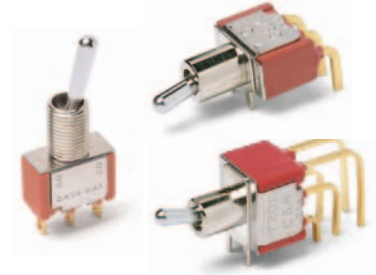

Specifications

CONTACT RATING: B contact material: 0.4 VA max. @ 20 V AC or DC max. Q contact material: 5 AMPS @ 120 V AC or 28 V DC; 2 AMPS @ 250 V AC. See page F-16 for additional ratings.

ELECTRICAL LIFE: 7X01 and UX1 models: 100,000 make-and-break cycles at full load. All other models: 40,000 cycles.

CONTACT RESISTANCE: Below 10 m Ω typ. initial @ 2-4 V DC, 100 mA, for both silver and gold plated contacts.

INSULATION RESISTANCE: 10⁹ Ω min.

DIELECTRIC STRENGTH: 1000 Vrms min. @ sea level.

OPERATING TEMPERATURE: -30°C to 85°C.

SOLDERABILITY: Per MIL-STD-202F method 208D, or EIA RS-186E method 9 (1 hour steam aging).

For materials see page F-4.

NOTE: Specifications listed above are for switches with standard options. For information on specific and custom switches, consult Customer Service Center.

Build-A-Switch

To order, simply select desired option from each category and place in the appropriate box. Available options are shown and described on pages F-4 thru F-16. For additional options not shown in catalog, consult our Customer Service Center.

<p>Switch Function</p> <p>7101 (STD.) SP On-None-On 7103 (STD.) SP On-Off-On 7105 SP Mom.-Off-Mom. 7107 SP On-Off-Mom. 7108 SP On-None-Mom. 7109 SP None-On-Mom. 7201 (STD.) DP On-None-On 7203 (STD.) DP On-Off-On 7205 DP Mom.-Off-Mom. 7207 DP On-Off-Mom. 7208 DP On-None-Mom. 7211 (STD.) DP On-On-On 7213 DP On-On-Mom. 7215 DP Mom.-On-Mom. 7301 (STD.) 3P On-None-On 7303 3P On-Off-On 7305 3P Mom.-Off-Mom. 7307 3P On-Off-Mom. 7308 3P On-None-Mom. 7401 (STD.) 4P On-None-On 7403 4P On-Off-On 7405 4P Mom.-Off-Mom. 7407 4P On-Off-Mom. 7408 4P On-None-Mom. 7411 4P On-On-On 7413 4P On-On-Mom. 7415 4P Mom.-On-Mom.</p> <p><small>Note: UL/CSA models available, see pages F-4 & F-5.</small></p>	<p>Actuator</p> <p>M (STD.) .200" high P3 (STD.) Flatted, anti-rotation, .450" high S (STD.) .420" high T (STD.) .687" high, 15/32 bushing K2 Locking lever, .704" high K9 Locking lever, .704" high K12 Locking lever, .732" high K19 Locking lever, .732" high L .840" high L1 .640" high L1P Anti-rotation, .640" high L2 .550" high L2P Anti-rotation, .550" high L3 Plastic, .840" high L3P Plastic, anti-rotation, .840" high L40 Lever handle without cap L41 .531" high lever handle with cap L42 .838" high lever handle with cap MP Anti-rotation, .200" high P1 Flatted, anti-rotation, .840" high P4 Flatted, anti-rotation, .250" high SP Anti-rotation, .420" high T1 .487" high, 15/32 bushing T1P Anti-rotation, .487" high, 15/32 bushing T2P Flatted, anti-rotation, .610" high, 15/32 bushing, 15/32 bushing TP Anti-rotation, .687" high, 15/32 bushing</p>	<p>Bushing</p> <p>D (STD.) .280 high, keyway H (STD.) .296 high, flat Y (STD.) .350 high, keyway NONE No bushing choice required CW Splashproof D8 .280" high, flat D9 .280" high, keyway H3 .315" high, keyway H4 8mm high, keyway Y1 .378" high, keyway Y3 8.9mm high, keyway Y4 .378" high, flat Y9 .350" high, keyway</p> <p>Terminations</p> <p>A (STD.) Right angle, PC thru-hole AV2 (STD.) Vert. right angle, PC thru-hole C (STD.) PC Thru-hole V3 (STD.) .460 high, V-bracket Z (STD.) Solder lug A2 Right angle, PC thru-hole A3 Right angle, PC thru-hole A4 Right angle, PC thru-hole AV3 Vert. right angle, PC thru-hole AW1 Right angle, extended, PC thru-hole AW3 Right angle, extended, PC thru-hole AW4 Right angle, extended, PC thru-hole V2 .555" high, V-bracket V4 .630" high, V-bracket V6 .460" high, V-bracket V7 .630" high, V-bracket V8 .953" high, V-bracket V9 1.150" high, V-bracket V21 .555" high, snap-in V-bracket V31 .460" high, snap-in V-bracket V41 .630" high, snap-in V-bracket</p>	<p>Contact Material</p> <p>B (STD.) Gold Q (STD.) Silver K Gold, tin-lead M Silver, tin-lead G Gold over silver L Gold over silver, tin-lead</p> <p>Seal</p> <p>E (STD.) Epoxy I Epoxy potted base</p> <p>Actuator Color/Finish</p> <p>NONE (STD.) Bright chrome 0 (STD) Actuator finish with black bushing 1 White 2 Black 3 Red S Satin chrome</p> <p>KXX Actuator Color/Finish</p> <p>NONE (STD.) Natural aluminum 0 (STD) Natural aluminum with black bushing 2 Black anodized aluminum 3 Red anodized aluminum 7 Blue anodized aluminum</p> <p>Bushing Finish</p> <p>NONE (STD.) Nickel on all bushings (except D8, satin chrome) 2 Black</p> <p>V61 .460" high, snap-in V-bracket V71 .630" high, snap-in V-bracket V81 .953" high, snap-in V-bracket W .750" long, wire wrap W1 .964" long, wire wrap W3 .425" long, wire wrap W4 1.062" long, wire wrap W5 1.305" long, wire wrap Z3 Quick connect</p>
--	--	---	---

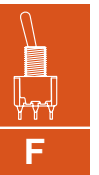

Toggle

C&K 7000 Series Miniature Toggle Switches

Materials

CASE: Glass filled nylon 6/6, flame retardant, heat stabilized, or diallyl phthalate (DAP) (UL 94V-0).

ACTUATOR: Brass, chrome plated.

BUSHING: Brass or zinc, nickel plated.

HOUSING: Stainless steel.

SWITCH SUPPORT: Brass or steel, tin plated.

END CONTACTS: B contact material: Copper alloy, with gold plate over nickel plate. Q contact material: Coin silver, silver plated. See page F-16 for additional contact materials.

CENTER CONTACTS & ALL TERMINALS: B contact material: Copper alloy, with gold plate over nickel plate. Q contact material: Copper alloy, silver plated. See above for additional contact materials.

TERMINAL SEAL: Epoxy.

HARDWARE: Nut & Locking Ring: Brass, nickel plated.
Lockwasher: Steel, nickel plated.

NOTE: Materials listed above are for switches with standard options. For information on specific and custom switches, consult Customer Service Center.

SWITCH FUNCTION



NO. POLES	MODEL NO.	UL/CSA** MODEL NO.	SWITCH FUNCTION			CONNECTED TERMINALS			SCHEMATIC
			POS. 1	POS. 2	POS. 3	POS. 1	POS. 2	POS. 3	
			KEYWAY	KEYWAY	KEYWAY	KEYWAY	KEYWAY	KEYWAY	
SP	7101 (STD.)	U11	ON	NONE	ON	2-3	N/A	2-1	
	7103 (STD.)	U13	ON	OFF	ON	2-3	OPEN	2-1	
	7105	U15	MOM.	OFF	MOM.				
	7107	U17	ON	OFF	MOM.				
	7108	U18	ON	NONE	MOM.	2-3	N/A	2-1	
	7109	U19	NONE	ON	MOM.	N/A	2-3	2-1	

SPDT

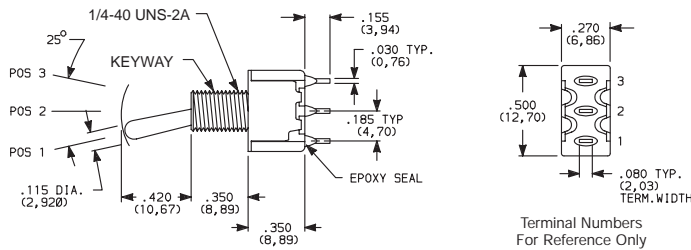

Part number shown: 7101SYZBE

NO. POLES	MODEL NO.	UL/CSA** MODEL NO.	SWITCH FUNCTION			CONNECTED TERMINALS			SCHEMATIC
			POS. 1	POS. 2	POS. 3	POS. 1	POS. 2	POS. 3	
			KEYWAY	KEYWAY	KEYWAY	KEYWAY	KEYWAY	KEYWAY	
DP	7201 (STD.)	U21	ON	NONE	ON	2-3,5-6	N/A	2-1,5-4	
	7203 (STD.)	U23	ON	OFF	ON	2-3,5-6	OPEN	2-1,5-4	
	7205	U25	MOM.	OFF	MOM.				
	7207	U27	ON	OFF	MOM.				
	7208	U28	ON	NONE	MOM.	2-3,5-6	N/A	2-1,5-4	
	7211 (STD.)*	U211*	ON	ON	ON	2-3,5-6	2-3,5-4	2-1,5-4	
	7213*	U213*	ON	ON	MOM.				
7215*	U215*	MOM.	ON	MOM.					

DPDT

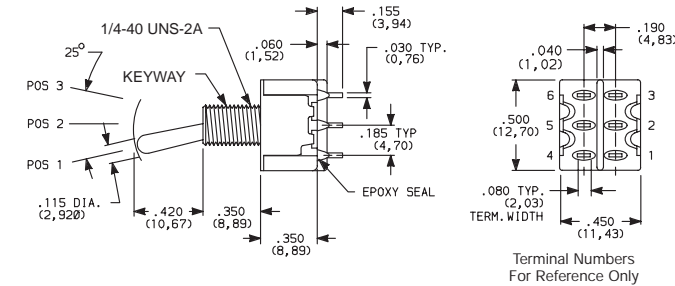

Part number shown: 7201SYZQE

MOM. = Momentary

** U11-U415 model nos. with all options when ordered with G, L, M or Q contact material.

* Wiring for 3-way switch, see Section N.

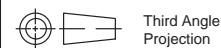

Dimensions are shown: IN (mm)
Dimensions subject to change

C&K 7000 Series Miniature Toggle Switches

SWITCH FUNCTION

NO. POLES	MODEL NO.	UL/CSA** MODEL NO.	SWITCH FUNCTION			CONNECTED TERMINALS			SCHEMATIC
			POS. 1 KEYWAY	POS. 2 KEYWAY	POS. 3 KEYWAY	POS. 1 KEYWAY	POS. 2 KEYWAY	POS. 3 KEYWAY	
3P	7301 (STD.)	U31	ON	NONE	ON	2-3,5-6,8-9	N/A	2-1,5-4,8-7	
	7303	U33	ON	OFF	ON	2-3,5-6,8-9	OPEN	2-1,5-4,8-7	
	7305	U35	MOM.	OFF	MOM.				
	7307	U37	ON	OFF	MOM.				
	7308	U38	ON	NONE	MOM.				

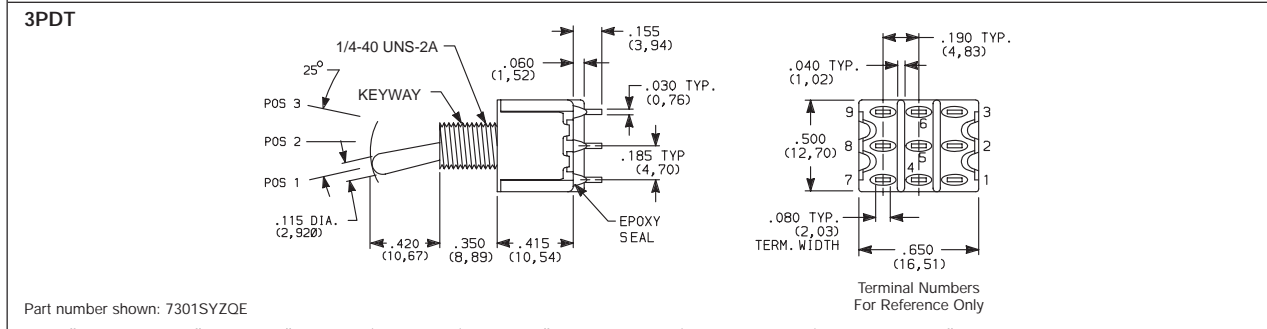

4P	7401 (STD.)	U41	ON	NONE	ON	2-3,5-6,8-9,11-12	N/A	2-1,5-4,8-7,11-10	
	7403	U43	ON	OFF	ON	2-3,5-6,8-9,11-12	OPEN	2-1,5-4,8-7,11-10	
	7405	U45	MOM.	OFF	MOM.				
	7407	U47	ON	OFF	MOM.				
	7408	U48	ON	NONE	MOM.				
	7411*	U411*	ON	ON	ON	2-3,5-6,8-9,11-12	2-3,5-4,8-9,11-10	2-1,5-4,8-7,11-10	
	7413*	U413*	ON	ON	MOM.				
7415*	U415*	MOM.	ON	MOM.					

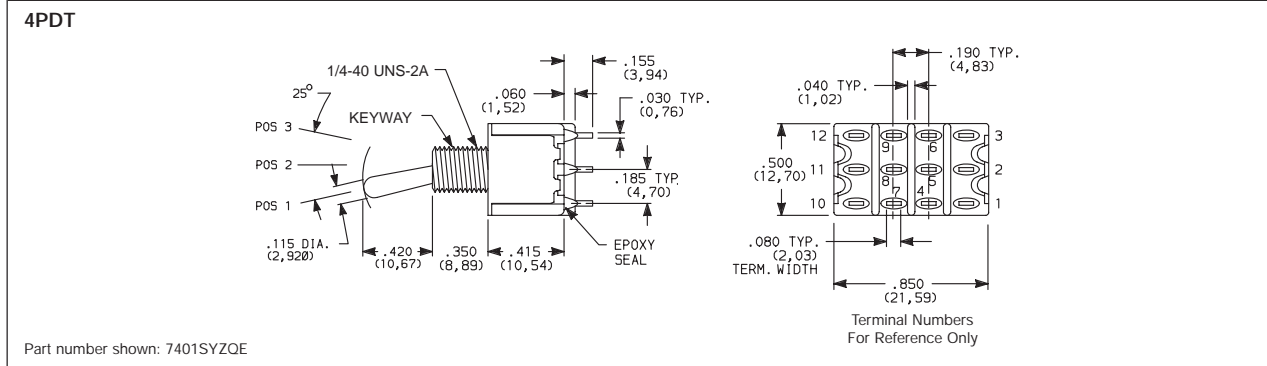

MOM. = Momentary
* Wiring for 3-way switch, see Section N.

** U11-U415 model nos. with all options when ordered with G, L, M or Q contact material.

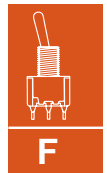

Toggle

C&K 7000 Series Miniature Toggle Switches

ACTUATOR

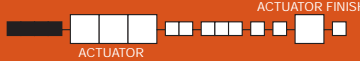

S (STD.) .420" HIGH ¹

SP ANTIROTATION, .420" HIGH ^{2,3}

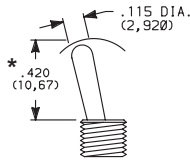

S actuator standard when ordered with C, W-W5, Z & Z3 terminations. Caps are available separately, see page F-16.

M (STD.) .200" HIGH ¹

MP ANTIROTATION, .200" HIGH ^{2,3}

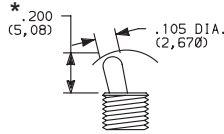

M actuator standard when ordered with all terminations except C, W-W5, Z & Z3. Caps are available separately, see page F-16.

L, L1, L2 .840", .640", .550" HIGH ¹

L1P, L2P ANTIROTATION, .840", .640", .550" HIGH ^{2,3}

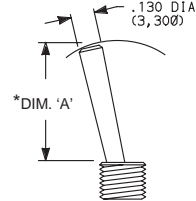

OPTION CODE	DIM 'A'
L	.840 (21, 34)
L1, L1P	.640 (16, 26)
L2, L2P	.550 (13, 97)

Caps are available separately, see page F-16.

P1 FLATTED WITH ANTIROTATION, .840" HIGH ^{2,3}

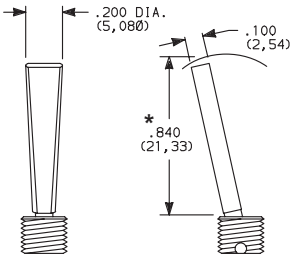

P3 (STD.) FLATTED WITH ANTIROTATION, .450" HIGH ^{2,3}

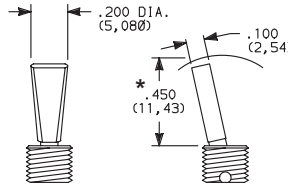

P4 FLATTED WITH ANTIROTATION, .250" HIGH ^{2,3}

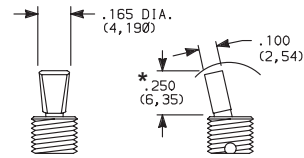

Dress nut part number 709901201 supplied standard with threaded bushing. (Part number 709903201 with metric threaded bushings.)

T (STD.) .687" HIGH ^{1,2}

TP ANTIROTATION, .687" HIGH, 15/32 BUSHING ^{1,2,3}

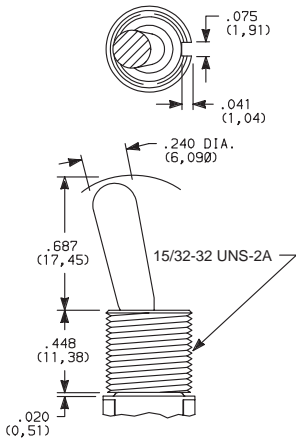

T1 .487" HIGH ^{1,2}

T1P ANTIROTATION, .487" HIGH, 15/32 BUSHING ^{1,2,3}

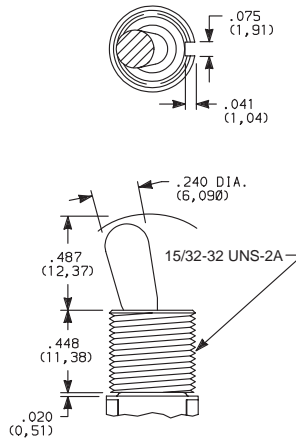

T2P

FLATTED, ANTIROTATION, .610" HIGH, 15/32 BUSHING ^{1,2,3}

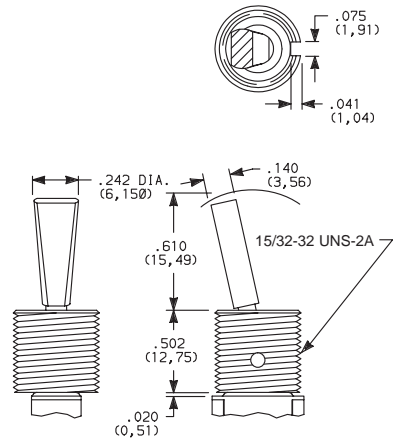

Bushing option code not required unless CW splashproof bushing ordered. TP & T1P actuators not available with CW splashproof bushing. All TXX actuators not available on single pole models with A-A7, AW-AW4, R terminations.

Bushing option code not required. T2P actuator not available with CW splashproof bushing or single pole models with A-A7, AW-AW4, R terminations.



Toggle

¹ L, L1, L2, M, S & TXX actuators not available with Y1 bushing.
² L1P, L2P, MP, P1, P3, P4, SP & TXX actuators not available with D8 & H4 bushing.
³ Antirotation: Provides anti-'push-in' feature on actuator.
 * Add .070 (1,78) for D, D8 & D9 bushings, subtract .020 (0,51) for H3 bushing.

OPTION CODE	ACTUATOR FINISH
NONE	(STD.) BRIGHT CHROME-With Nickel Plated Bushing
2	(STD.) BLACK
0	BRIGHT CHROME-With Black Bushing
S	SATIN CHROME

NOTE: Black hardware is supplied when either black actuators or bushings are specified. For additional hardware, see section N.

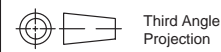

Dimensions are shown: IN (mm)
 Dimensions subject to change

C&K 7000 Series Miniature Toggle Switches

ACTUATOR

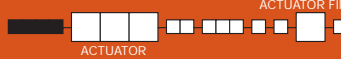

- K2** LOCKING LEVER, .704" HIGH (threaded)
- K9** LOCKING LEVER, .704" HIGH (unthreaded)

- K12** LOCKING LEVER, .732" HIGH (threaded)
- K19** LOCKING LEVER, .732" HIGH (unthreaded)

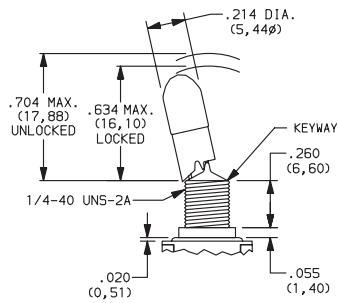

Replaces K, K8

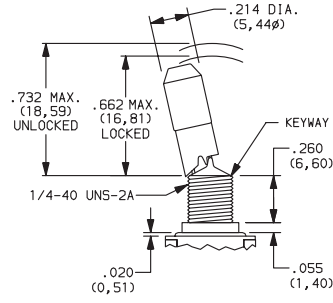

Replaces K1, K18

OPTION CODE	ACTUATOR CAP FINISH
NONE	(STD.) NATURAL ALUMINUM-With Nickel Plated Bushing
0	(STD.) NATURAL ALUMINUM-With Black Bushing
2	BLACK ANODIZED ALUMINUM
3	RED ANODIZED ALUMINUM
7	BLUE ANODIZED ALUMINUM

Locking Positions



-01 Models
2 Position lock

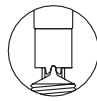

-03 & -11 Models
3 Position lock



-05, -09 & -15 Models
1 Position lock



-07 & -13 Models
2 Position lock



-08 Models
1 Position lock

NOTE: To prevent accidental actuation, toggle must be lifted before being actuated. When released, toggle will lock in place. Overtightening mounting nut may cause actuator to bind. Locking levers supplied with bushing shown. Bushing option code not required unless CW splashproof bushing ordered.

- L40** LEVER HANDLE WITHOUT CAP

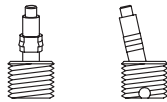

No color choice required.

- L41** PLASTIC LEVER HANDLE WITH ANTIROTATION AND CAP, P/N 4810

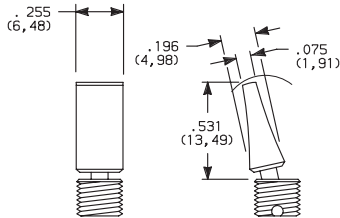

Finish: Matte (L41 & L42).

- L42** PLASTIC LEVER HANDLE WITH ANTIROTATION AND CAP, P/N 4811

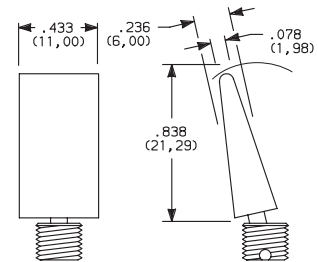

- L3** PLASTIC, .840" HIGH

- L3P** ANTIROTATION, .840" HIGH

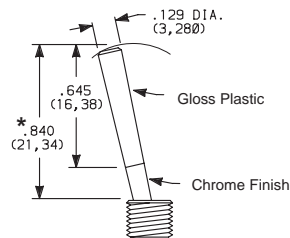

OPTION CODE	PLASTIC ACTUATOR COLORS
NONE	(STD.) No Actuator Color (L40 option)
2	(STD.) BLACK
1	WHITE
3	RED

NOTE: Lever handle for L41 & L42 actuators supplied, but not installed. For interchangeability, order L40 actuator option and lever handles separately, see page F-17. L4X actuators not available with H4, Y1, Y4 bushings. Antirotation: Provides anti-'push-in' feature on actuator.

* Add .070 (1,78) for D, D8 & D9 bushings, subtract .020 (0,51) for H3 bushing.



C&K 7000 Series Miniature Toggle Switches

BUSHING

BUSHING FINISH

BUSHING

Y (STD.) .350" HIGH, THREADED, KEYWAY

NONE NO BUSHING

D (STD.) .280" HIGH, THREADED, KEYWAY

H (STD.) .296" HIGH, FLAT THREADED, HIGH TORQUE 1,2

H3 .315" HIGH, KEYWAY THREADED, HIGH TORQUE 1,2

Y9 .350" HIGH, UNTHREADED, KEYWAY

D8 .280" HIGH, UNTHREADED, FLAT 3
D9 .280" HIGH, UNTHREADED, KEYWAY

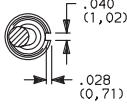

No bushing choice required with KXX, TXX actuators. (exception: Specify CW if splashproof bushing desired).

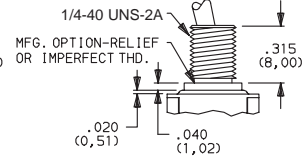
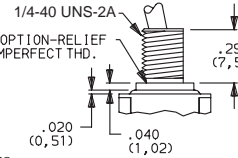
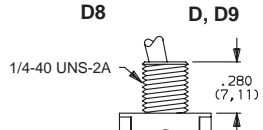
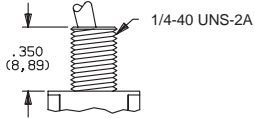
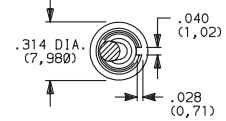
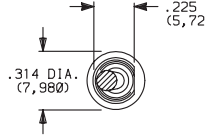
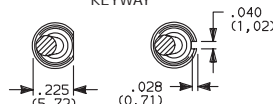

Y bushing standard with C, W-W5, Z or Z3 terminations.

D9 bushing standard with all terminations except C, W-W5, Z or Z3. Add .070 (1,78) to all actuators lengths with D, D8 & D9 bushings.

Subtract .020 (0,51) from all actuator lengths for H3 bushing.

H4 8mm HIGH, KEYWAY, THREADED, METRIC HIGH TORQUE 1,2,3

Y1 .378" HIGH, KEYWAY, THREADED, HIGH TORQUE 1,2,4

Y3 8.9mm HIGH, KEYWAY, THREADED, METRIC

Y4 .378" HIGH, FLAT, THREADED, HIGH TORQUE 1,2,5

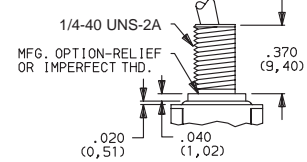
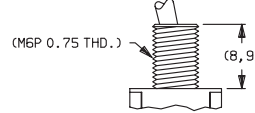
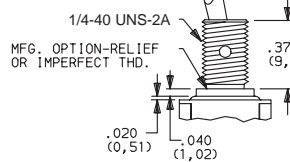
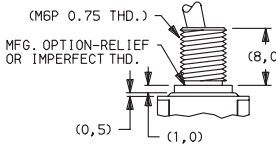
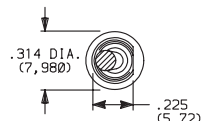
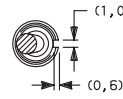
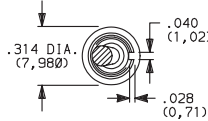
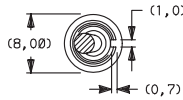

CW THREADED, SPLASHPROOF 1,2

For T & T1 actuators.

For actuators other than T & T1.

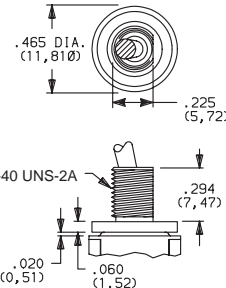
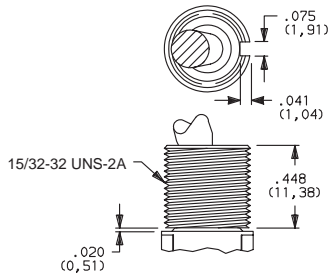

OPTION CODE	BUSHING FINISH
NONE	(STD.) NICKEL on all bushings except 'D8' satin chrome.
2	BLACK

IP67 Degree of protection, totally protected against dust, full-scale voltage protection, temporary immersion. Internal actuator seal standard. External bushing seal washer available separately, order from: Multi-Flex Seals, Inc., Hackensack, NJ. Part number: MFS-60064.

IP67 Degree of protection, totally protected against dust, full-scale voltage protection, temporary immersion. Internal actuator seal and external bushing seal washer standard.

- 1 Will withstand 12 in.-lbs. of torque with no distortion.
- 2 CW, H, H3, H4, Y1 & Y4 bushings not available on single pole models with A4, R terminations.
- 3 D8 & H4 bushings available only with L, L1, L2, L3, M & S actuators.
- 4 Y1 bushing available only with LP, LXP, MP, PX & SP actuators.
- 5 Y4 bushing not available with L4X actuators.

NOTE: Two mounting nuts, locking ring and lockwasher supplied standard with threaded bushings. Black hardware is supplied when either black bushings or actuators are specified. Optional mounting nut and locking ring styles and finishes available, see section N.

PANEL MOUNTING

1/4 INCH BUSHING

METRIC BUSHING

15/32 INCH BUSHING

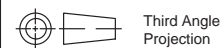
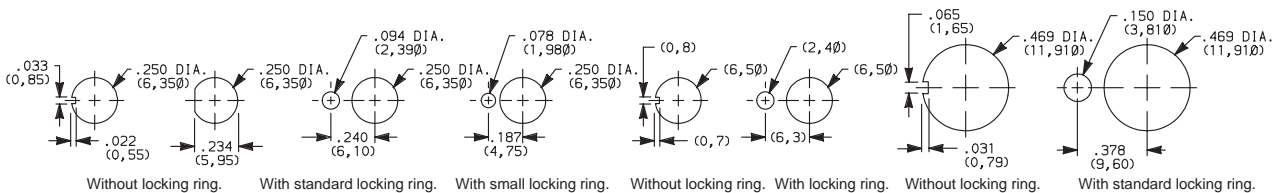

Third Angle Projection
Dimensions are shown: IN (mm)
Dimensions subject to change

Toggle

F

C&K 7000 Series Miniature Toggle Switches

TERMINATIONS

Z (STD.) SOLDER LUG

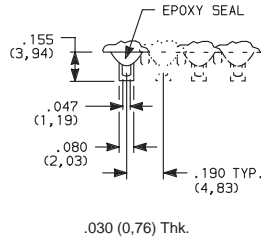

C (STD.) PC THRU-HOLE

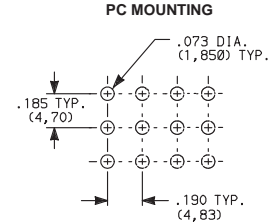
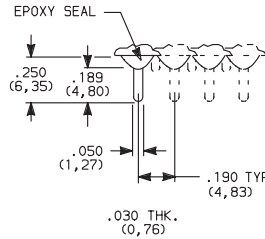

SPDT thru 4PDT

Not available with K, L or M contact materials.

SPDT thru 4PDT

Z3 QUICK CONNECT

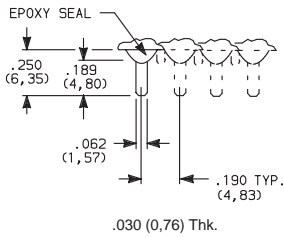

Not available with K, L or M contact materials.
Mating quick connector available, order part number 530100000, page F-17.

W, W1, W3, W4, W5 WIRE WRAP

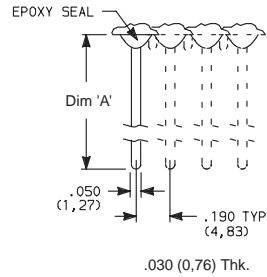

OPTION CODE	DIM 'A'
W	.750 (19,05)
W1	.964 (24,48)
W3	.425 (10,80)
W4	1.062 (26,97)
W5	1.305 (33,15)

SPDT thru 4PDT

SPDT thru 4PDT

A (STD.) RIGHT ANGLE, PC THRU-HOLE

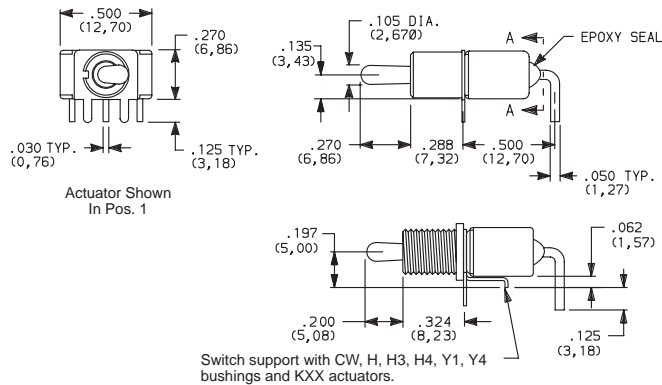

Part No. Shown: 7101MHABE

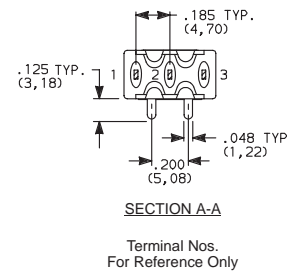

7101MD9ABE
Horizontal Actuation
SPDT

A3 RIGHT ANGLE, SNAP-IN, PC THRU-HOLE

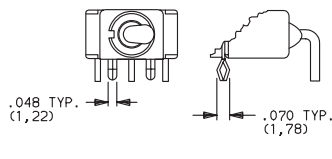

AW1, AW3, AW4 RIGHT ANGLE, EXTENDED, PC THRU-HOLE

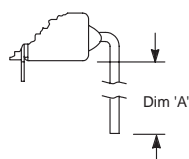

OPTION CODE	DIM 'A'
AW1	.72 (18,3)
AW3	.20 (5,1)
AW4	.83 (21,1)

PC MOUNTING

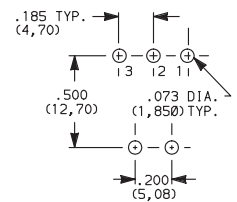

Not available with I seal option.
Terminal bend radii and lead-in manufacturing option.

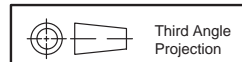

Dimensions are shown: IN (mm)
Dimensions subject to change

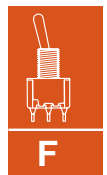

F

Toggle

C&K 7000 Series Miniature Toggle Switches

TERMINATIONS

A (STD.) RIGHT ANGLE, PC THRU-HOLE



7201MD9ABE
Horizontal Actuation
DPDT

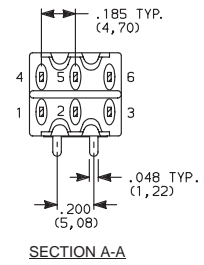
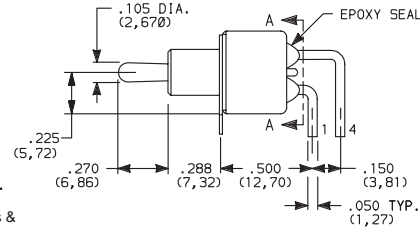
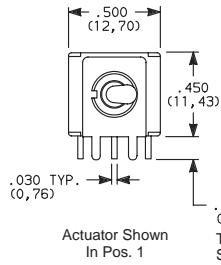

A3 RIGHT ANGLE, SNAP-IN, PC THRU-HOLE

AW1, AW4 RIGHT ANGLE, EXTENDED, PC THRU-HOLE

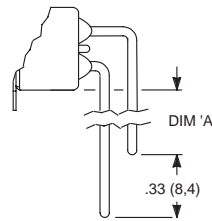
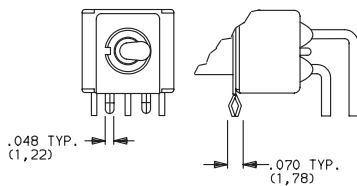

OPTION CODE	DIM 'A'
AW1	.40 (10,2)
AW4	.50 (12,7)

PC MOUNTING

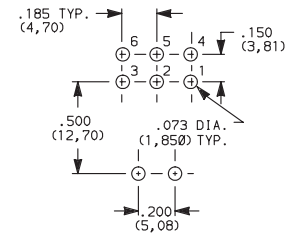

Not available with I seal option.
Terminal bend radii and lead-in manufacturing option.

A (STD.) RIGHT ANGLE, PC THRU-HOLE



7301MD9ABE
Horizontal Actuation
3PDT

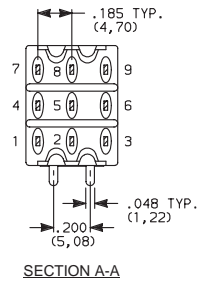
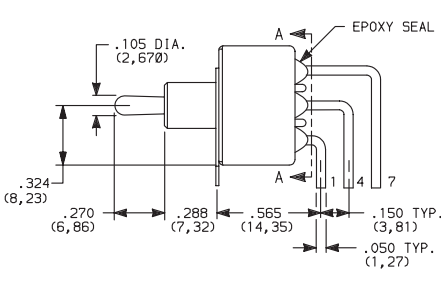
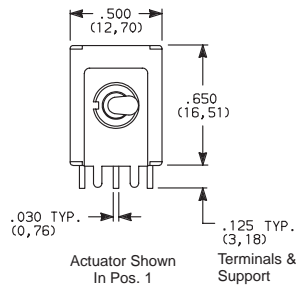

AW4 RIGHT ANGLE, EXTENDED, PC THRU-HOLE



Toggle

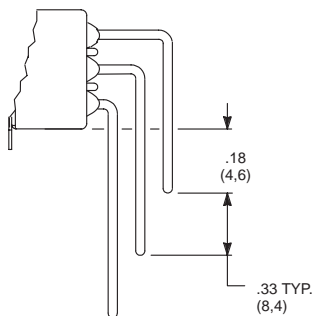

PC MOUNTING

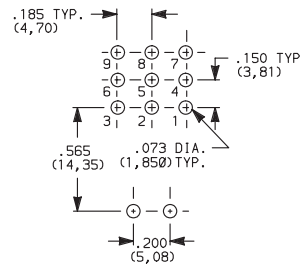

Not available with I seal option.
Terminal bend radii and lead-in manufacturing option.

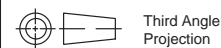

Third Angle
Projection

C&K 7000 Series Miniature Toggle Switches

TERMINATIONS

A2 RIGHT ANGLE, PC THRU-HOLE, .156" PITCH

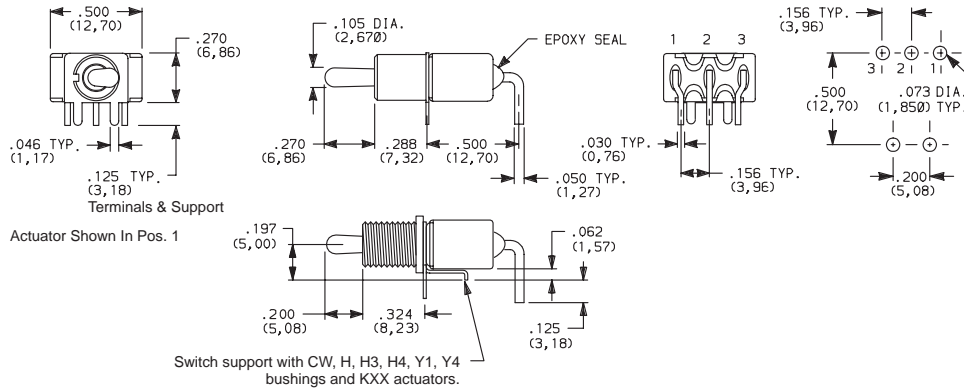

7101MHA2BE
Horizontal Actuation
SPDT

Not available with TXX actuators and I seal.
Terminal bend radii and lead-in manufacturing option.
Part No. Shown: 7101MHA2BE

A4 RIGHT ANGLE, PC THRU-HOLE .156" PITCH

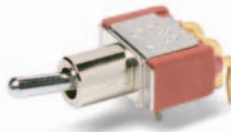
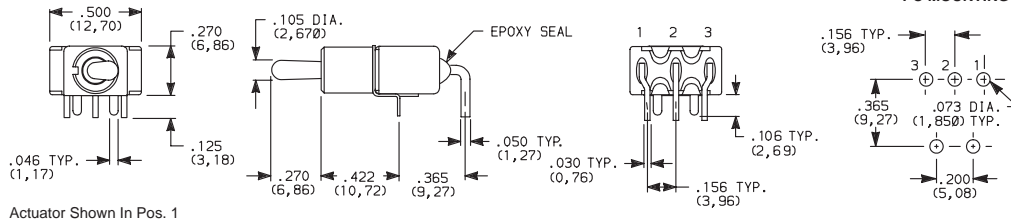

7101MD9A4BE
Horizontal Actuation
SPDT

Not available with KXX & TXX actuators, CW, H, H3, H4, Y1 & Y4 bushings, and I seal. Terminal bend radii and lead-in manufacturing option.

NOTE: The A4 option is available with any contact material and can be UL recognized and CSA certified. The PC pattern must clear switch support legs.

AV2 (STD.) VERTICAL RIGHT ANGLE, PC THRU-HOLE, .150" PITCH

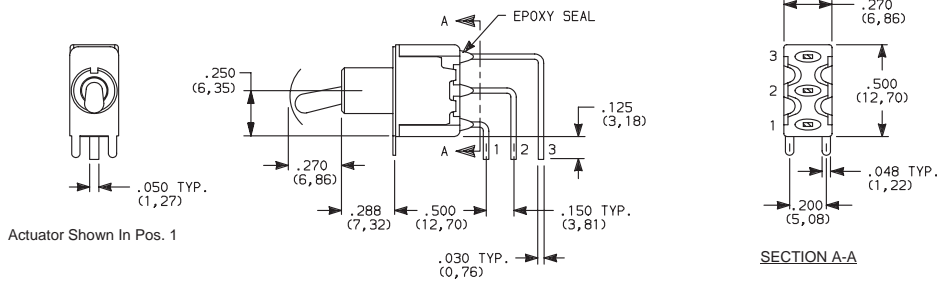

7101MD9AV2BE
Horizontal Actuation
SPDT

AV3 VERTICAL RIGHT ANGLE, SNAP-IN, PC THRU-HOLE, .150" PITCH

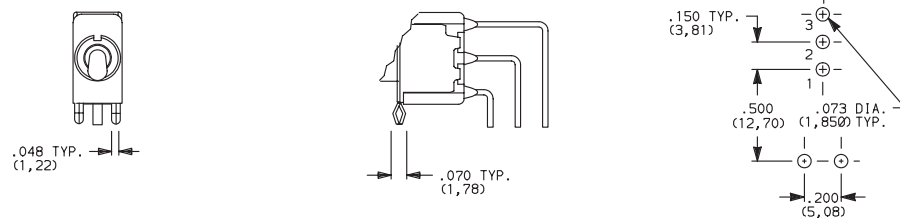

Not available with I seal option.
Terminal bend radii and lead-in manufacturing option.



Third Angle
Projection
Dimensions are shown: IN (mm)
Dimensions subject to change

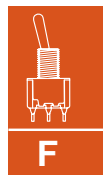

C&K 7000 Series Miniature Toggle Switches

TERMINATIONS

AV2 (STD.) VERTICAL RIGHT ANGLE, PC THRU-HOLE, .150" PITCH



7201MD9AV2BE
Vertical Actuation
DPDT

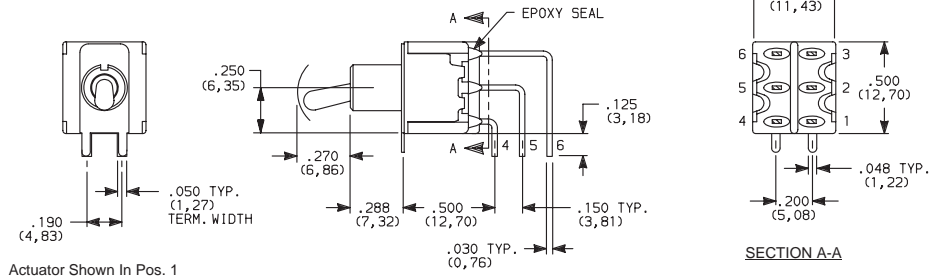

AV3 VERTICAL RIGHT ANGLE, SNAP-IN, PC THRU-HOLE, .150" PITCH



PC MOUNTING

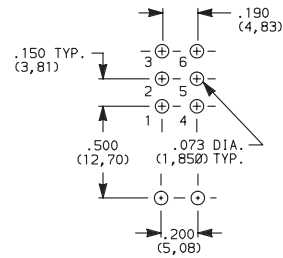

Not available with I seal option.
Terminal bend radii and lead-in manufacturing option.

AV2 (STD.) VERTICAL RIGHT ANGLE, PC THRU-HOLE, .150" PITCH



7301MD9AV2BE
Vertical Actuation
3PDT

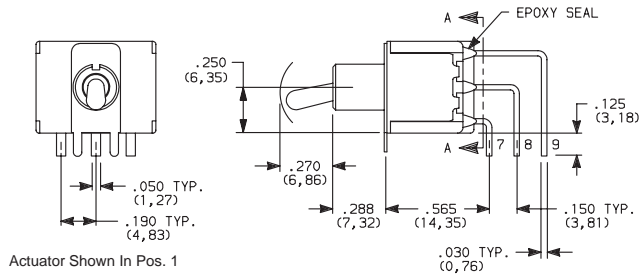

SECTION A-A

AV3 VERTICAL RIGHT ANGLE, SNAP-IN, .150" PITCH



PC MOUNTING

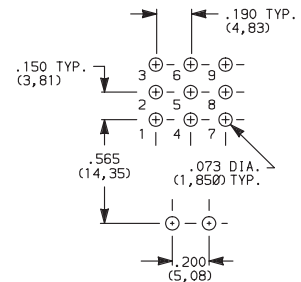

Not available with I seal option.
Terminal bend radii and lead-in manufacturing option.



Dimensions are shown: IN (mm)
Dimensions subject to change

C&K 7000 Series Miniature Toggle Switches

TERMINATIONS

AV2 (STD.) VERTICAL RIGHT ANGLE, PC THRU-HOLE, .150" PITCH

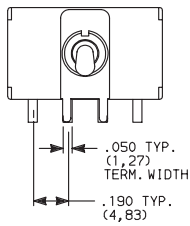

Actuator Shown In Pos. 1

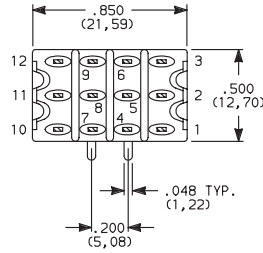
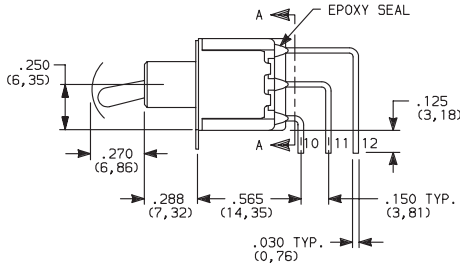

SECTION A-A



7401MD9AV2BE
Vertical Actuation
4PDT

AV3 VERTICAL RIGHT ANGLE, SNAP-IN, PC THRU-HOLE .150" PITCH

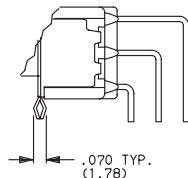
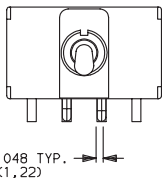

Not available with I seal option.
Terminal bend radii and lead-in manufacturing option.

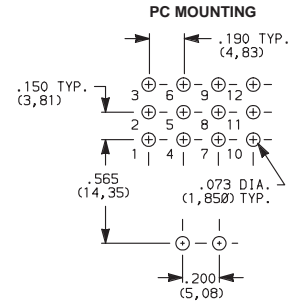

V2, V6, V7, V8 VERTICAL MOUNT, V-BRACKET

V21, V61, V71, V81 VERTICAL MOUNT, V-BRACKET, SNAP-IN

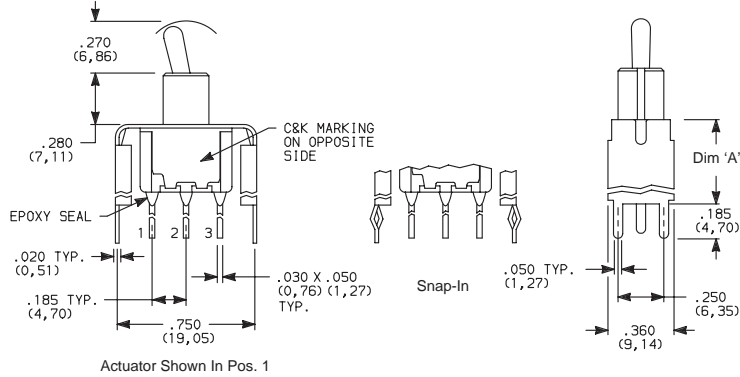

Actuator Shown In Pos. 1

Not available with I seal option.

PC MOUNTING

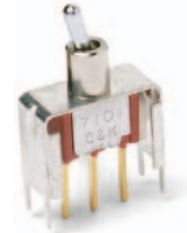
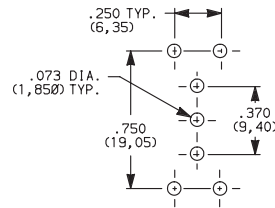

7101MD9_BE
SPDT

OPTION CODE	DIM 'A'
V2, V21	.555 (14,10)
V6, V61	.460 (11,68)
V7, V71	.630 (16,00)
V8, V81	.953 (24,21)

V2, V6, V7, V8 VERTICAL MOUNT, V-BRACKET

V21, V61, V71, V81 VERTICAL MOUNT, V-BRACKET, SNAP-IN

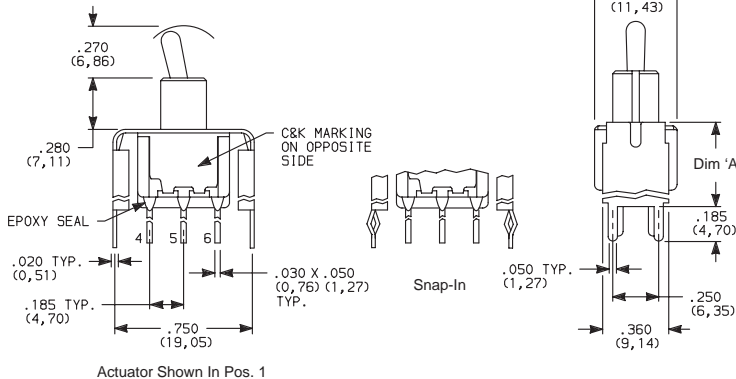

Actuator Shown In Pos. 1

Not available with I seal option.

PC MOUNTING

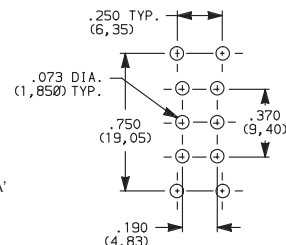

OPTION CODE	DIM 'A'
V2, V21	.555 (14,10)
V6, V61	.460 (11,68)
V7, V71	.630 (16,00)
V8, V81	.953 (24,21)

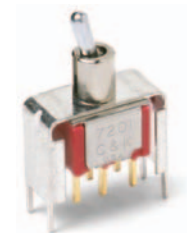

7201MD9_BE
DPDT

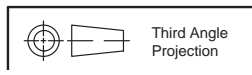

Dimensions are shown: IN (mm)
Dimensions subject to change



Cannon

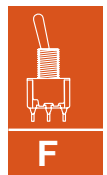

F

Toggle

C&K 7000 Series Miniature Toggle Switches

TERMINATIONS

V2, V7, V8 VERTICAL MOUNT, V-BRACKET

V21, V71, V81 VERTICAL MOUNT, V-BRACKET, SNAP-IN

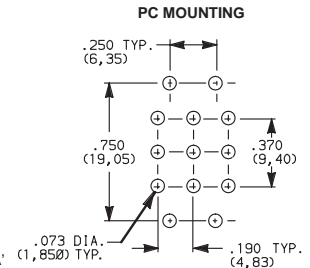
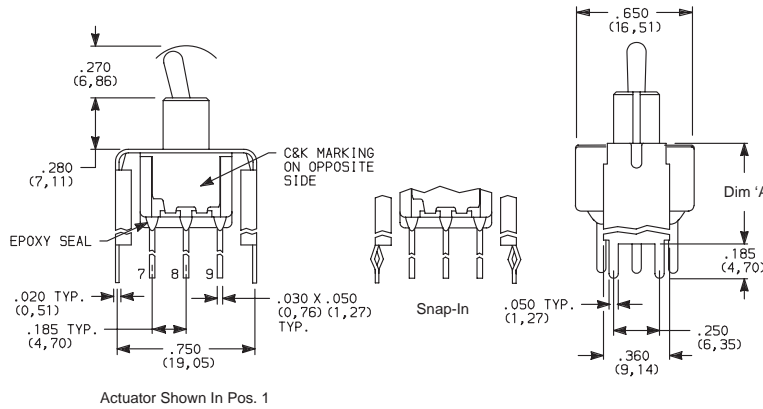

OPTION CODE	DIM 'A'
V2, V21	.555 (14,10)
V7, V71	.630 (16,00)
V8, V81	.953 (24,21)

Not available with I seal option.

V2, V7, V8 VERTICAL MOUNT, V-BRACKET

V21, V71, V81 VERTICAL MOUNT, V-BRACKET, SNAP-IN

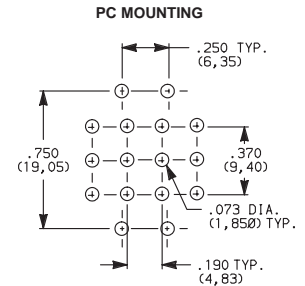
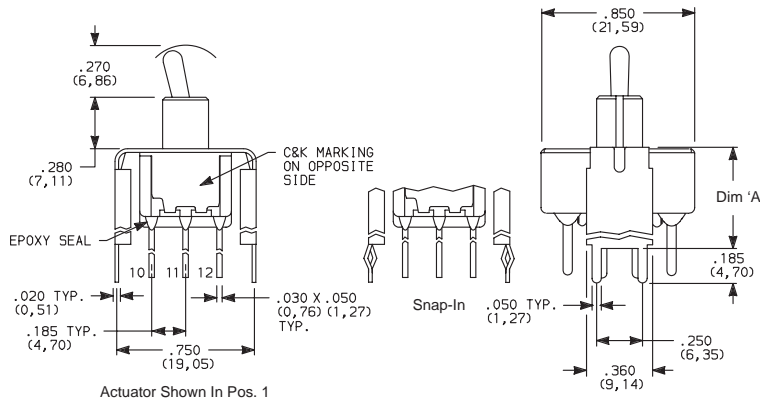
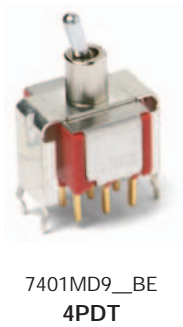

OPTION CODE	DIM 'A'
V2, V21	.555 (14,10)
V7, V71	.630 (16,00)
V8, V81	.953 (24,21)

Not available with I seal option.

V3 (STD.), V4, V9 VERTICAL MOUNT, V-BRACKET

V31, V41 VERTICAL MOUNT, V-BRACKET, SNAP-IN

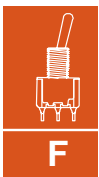

Toggle

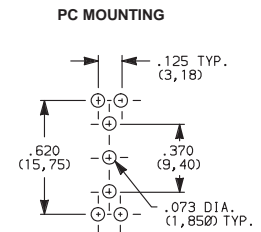
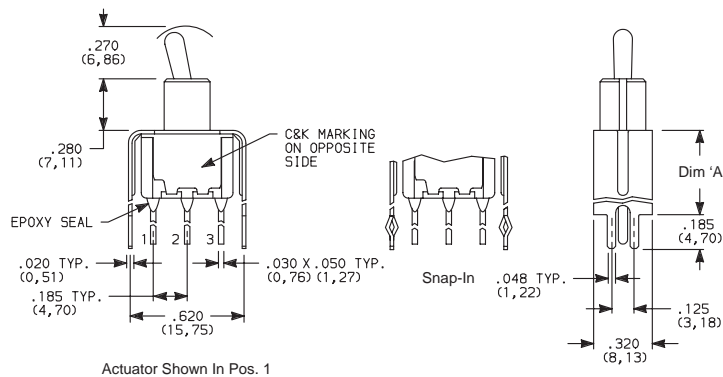

OPTION CODE	DIM 'A'
V3, V31	.460 (11,68)
V4, V41	.630 (16,00)
V9	1.150 (29,21)

Not available with I seal option.



C&K 7000 Series Miniature Toggle Switches

TERMINATIONS

V3 (STD.), V4, V9 VERTICAL MOUNT, V-BRACKET

V31, V41 VERTICAL MOUNT, V-BRACKET, SNAP-IN

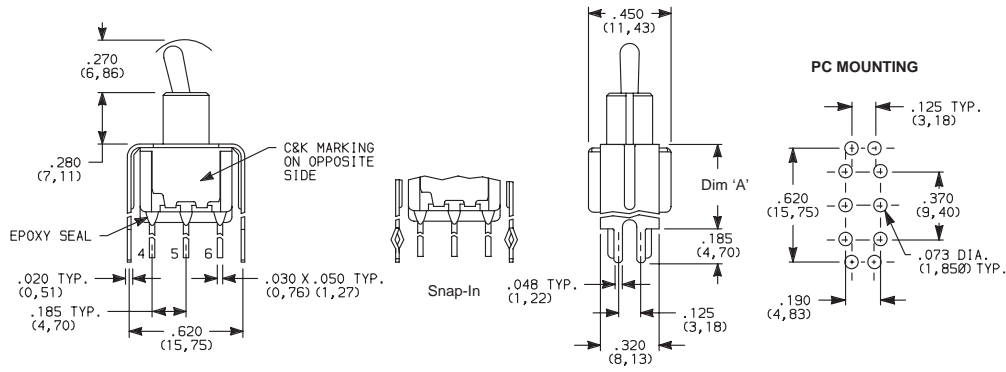

7201MD9_BE
DPDT

OPTION CODE	DIM 'A'
V3, V31	.460 (11,68)
V4, V41	.630 (16,00)
V9	1.150 (29,21)

Not available with I seal option.

V4, V9 VERTICAL MOUNT, V-BRACKET

V41 VERTICAL MOUNT, V-BRACKET, SNAP-IN

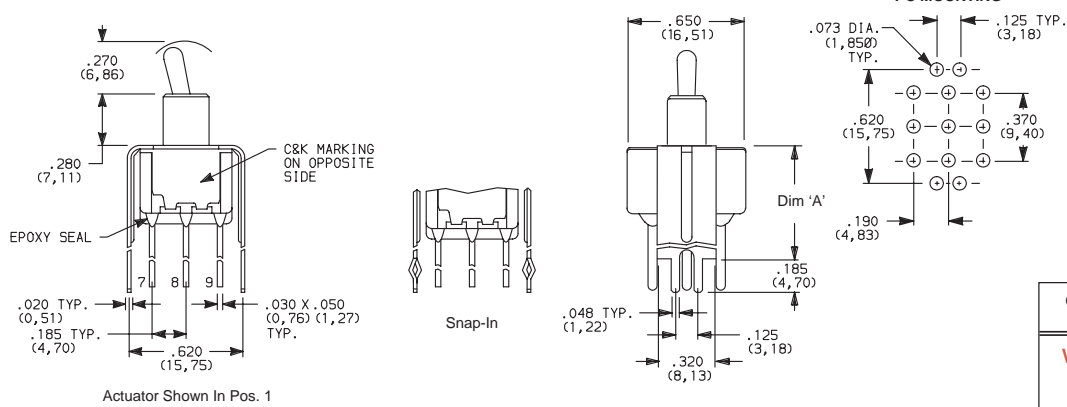

7301MD9_BE
3PDT

OPTION CODE	DIM 'A'
V4, V41	.630 (16,00)
V9	1.150 (29,21)

Not available with I seal option.

V4, V9 VERTICAL MOUNT, V-BRACKET

V41 VERTICAL MOUNT, V-BRACKET, SNAP-IN

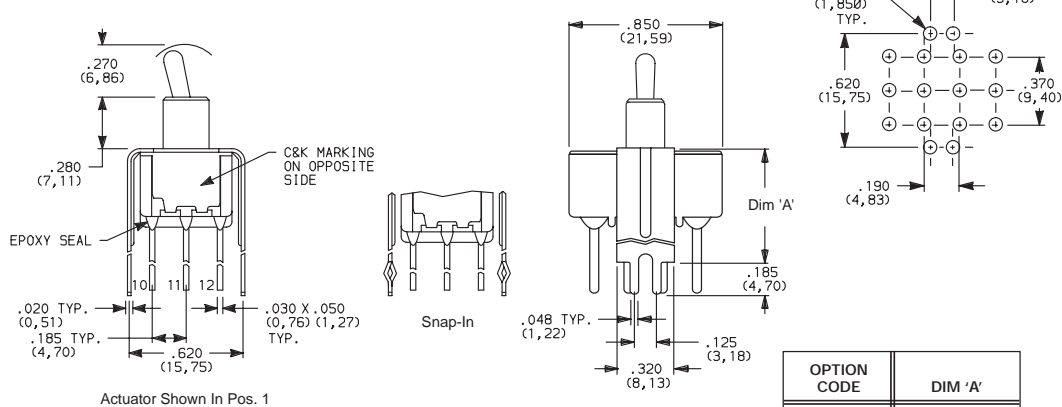

7401MD9_BE
4PDT

OPTION CODE	DIM 'A'
V4, V41	.630 (16,00)
V9	1.150 (29,21)



Third Angle Projection
Dimensions are shown: IN (mm)
Dimensions subject to change

Not available with I seal option.



Cannon



Toggle

C&K 7000 Series Miniature Toggle Switches

CONTACT MATERIAL

OPTION CODE	CONTACT MATERIAL	TERMINAL PLATING	RATINGS	
B (STD.)	GOLD ¹	GOLD ¹	LOW LEVEL/DRY CIRCUIT	0.4 VA MAX. @ 20 V AC OR DC MAX.
K		TIN-LEAD ⁶		
Q (STD.)	SILVER ^{4,5}	SILVER ⁵	POWER	5 AMPS @ 120 V AC OR 28 V DC; 2 AMPS @ 250 V AC.
M		TIN-LEAD ⁶		
G	GOLD OVER SILVER ^{2,3}	GOLD ³	LOW LEVEL/DRY CIRCUIT OR POWER	0.4 VA MAX @ 20 V AC OR DC MAX OR 5 AMPS @ 120 V AC OR 28 V DC; 2 AMPS @ 250 V AC.
L		TIN-LEAD ⁶		

CONTACT MATERIAL/APPLICATION RECOMMENDATIONS--SEE SECTION N.

¹ CONTACTS & TERMINALS: Copper alloy, with gold plate over nickel plate.

² END CONTACTS: Coin silver, with gold plate over nickel plate.

³ CENTER CONTACTS & ALL TERMINALS: Copper alloy, with gold plate over nickel plate.

⁴ END CONTACTS: Coin silver, silver plated.

⁵ CENTER CONTACT & ALL TERMINALS: Copper alloy, silver plated.

⁶ TERMINALS: Copper alloy, with tin-lead alloy over nickel plate.

U11-U415 model numbers   with all options when ordered with G, L, M or Q contact material.

B contact material standard with all terminations except C, Z & Z3.

B contact material standard must be ordered with A7 & R terminations.

Q contact material standard with C, Z & Z3 terminations.

K, L & M contact materials not available with Z & Z3 terminations.

SEAL

E (STD.) EPOXY SEAL

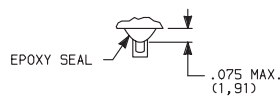

Compatible with "bottom-wash" PC board cleaning methods.

I EPOXY POTTED BASE

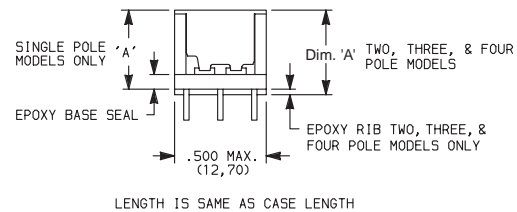

NO. POLES	DIM 'A'
SP	.410 (10,41)
DP	.440 (11,18)
3P	.505 (12,83)
4P	.505 (12,83)

Available with C, W-W5, Z & Z3 terminations only.

AVAILABLE HARDWARE

Cap

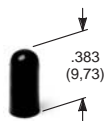

PART NO.

896801000 WHITE
896802000 BLACK
896803000 RED

Material: Polyethylene
Finish: Matte

Cap



PART NO.

763701000 WHITE
763702000 BLACK
763703000 RED

Material: Vinyl
Finish: Matte

Cap

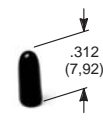

PART NO.

706201000 WHITE
706202000 BLACK
706203000 RED

Material: Vinyl
Finish: Matte

Toggle

F

C&K 7000 Series Miniature Toggle Switches

AVAILABLE HARDWARE

L41 Lever handle



PART NO.

481001000 WHITE
481002263 BLACK
481003000 RED

Material: Nylon
Finish: Matte

L42 Lever handle

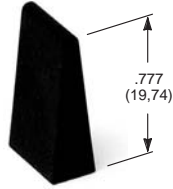

PART NO.

481101000 WHITE
481102263 BLACK
481103000 RED

Material: Nylon
Finish: Matte

Fits Z3 Termination
female connector



PART NO.

530100000

Available in loose pieces.

NOTE: Additional nuts, locking rings and lockwashers available separately, see section N.

Other colors available, consult Customer Service Center.



Toggle

Looking for pricing, stock, or lifecycle information?

Click below to explore more details on WIN SOURCE:

 [View 7101TV41LE on WIN SOURCE](#)

 [C&K Components Information](#)

Optimize Your Supply Chain with WIN SOURCE Solutions

-  Global Sourcing Solution
-  Obsolete Management
-  Cost Control Management
-  Shortage Management
-  Alternative Solution
-  Excess Inventory Management