



**THE DATASHEET OF
6V5C1**



MONOLITHIC TRANSIL® ARRAY FOR DATA LINE PROTECTION

FEATURES

- HIGH SURGE CAPABILITY TRANSIL ARRAY
 $I_{PP} = 40\text{ A } 8/20\mu\text{s}$
- UP TO 5 BIDIRECTIONAL TRANSIL FUNCTIONS
- BREAK DOWN VOLTAGE AND MAXIMUM DIFFERENTIAL VOLTAGE BETWEEN TWO INPUT PINS:
ITA6V5 = 6.5 V
ITA10 = 10 V
ITA18 = 18 V
ITA25 = 25 V
- LOW CLAMPING FACTOR (V_{CL} / V_{BR}) AT HIGH CURRENT LEVEL
- LOW LEAKAGE CURRENT
- LOW INPUT CAPACITANCE

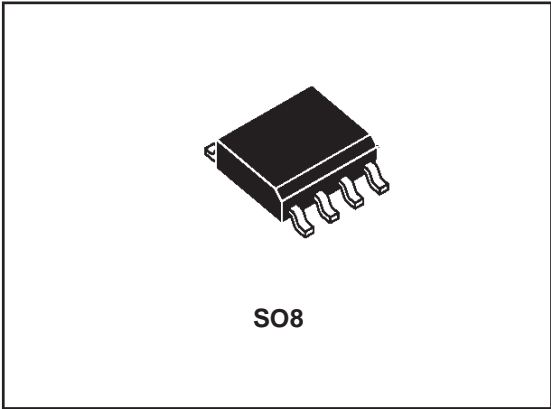

DESCRIPTION

This is a specific transil array for RS232, RS423 interface protection developed in monolithic chip form in order to provide a high surge capability and a low clamping voltage

IN ACCORDANCE WITH :

- ESD standard :
 - . IEC 801-2 15kV 5ns / 50ns
 - . IEC 801-4 40A 5ns / 50ns
 - . IEC 801-5 1kV 1.2 / 50µs
 - 25A 8 / 20µs

- . MIL STD 883C - Method 3015-2
 $V_P = 25\text{ kV}$
 $C = 150\text{ pF}$
 $R = 150\Omega$
 5 s duration

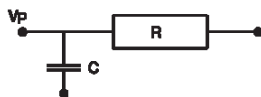

- Human body test :
 $V_P = 4\text{ kV}$
 $C = 150\text{ pF}$
 $R = 150\Omega$

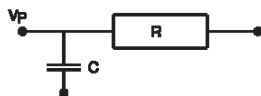

FUNCTIONAL DIAGRAM

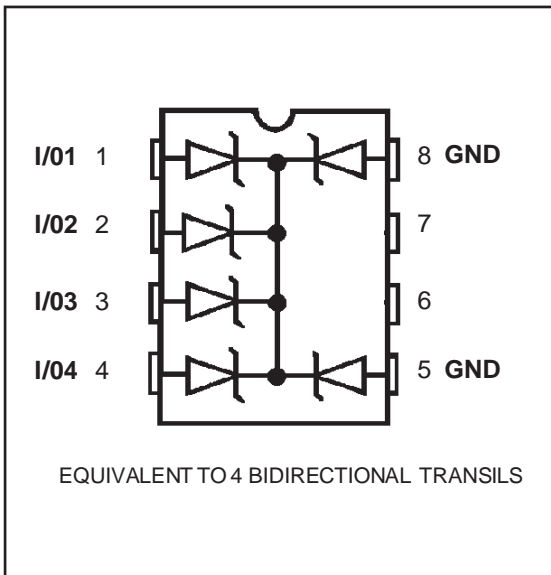

ITA6V5C1/ITA10C1 / ITA18C1 / ITA25C1

ABSOLUTE RATINGS (limiting values) (0°C ≤ Tamb ≤ 70°C)

Symbol	Parameter	Value	Unit	
I _{PP}	Peak pulse current for 8/20 μsexponential pulse	See note	40	A
I ² t	Wire I ² t value	See note	0.6	A ² s
T _{stg} T _j	Storage and Junction Temperature Range	- 55 to + 150 125	°C °C	

Note :

For surges greater than the maximum value specified, the input/output will present first a short circuit to the common bus line and after an open circuit caused by the wire.

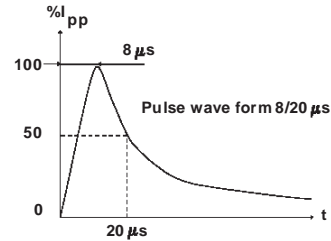

ELECTRICAL CHARACTERISTICS

Symbol	Parameter
I _{RM}	Leakage Current @ V _{RM}
V _{RM}	Stand-off Voltage
V _{BR}	Breakdown Voltage
V _{CL}	Clamping Voltage
I _{PP}	Surge Current
C	Input Capacitance

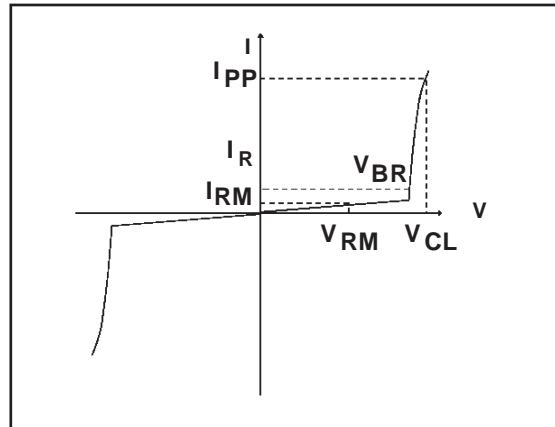

Types	I _{RM} @ V _{RM}		V _{BR} @ I _R		V _{CL} @ I _{PP}		V _{CL} I _{PP}		C 1	C 2	αT
	max		min		8/20μs		max	8/20μs	max	max	max
	μA	V	Note 1		Note 1		Note 1		Note 2	Note 3	
			V	mA	V	A	V	A	pF	pF	10 ⁻⁴ /°C
ITA6V5C1	10	5	6.5	1	10	10	12	25	750	550	4
ITA10C1	10	8	10	1	15	10	19	25	570	260	8
ITA18C1	4	15	18	1	25	10	28	25	350	180	9
ITA25C1	4	24	25	1	33	10	38	25	300	100	12

All parameters tested at 25°C, except where indicated.

Note 1: Between I/O pin and ground.

Note 2: Between two input Pins at 0 V Bias.

Note 3: Between two input Pins at V_{RM}.

Fig.1 : Typical Peak pulse power versus exponential pulse duration.

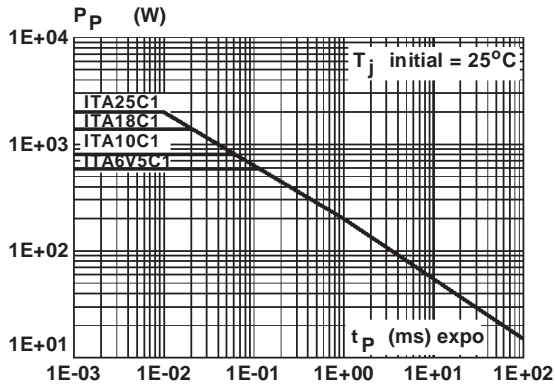

Fig.2 : Clamping voltage versus peak pulse current exponential waveform 8/20 μs.

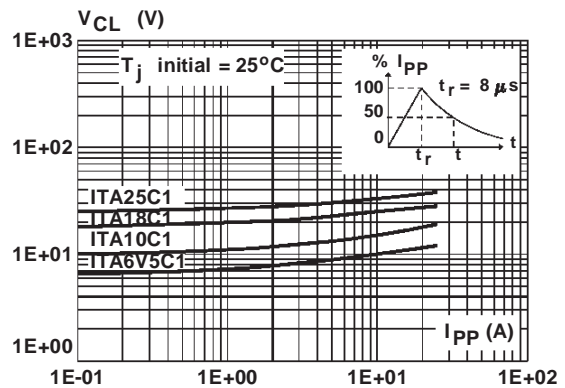

Fig.3 : Peak current I_{DC} inducing open circuit of the wire for one input/output versus pulse duration (typical values).

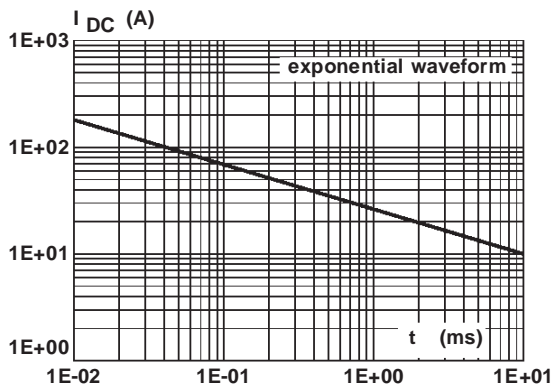
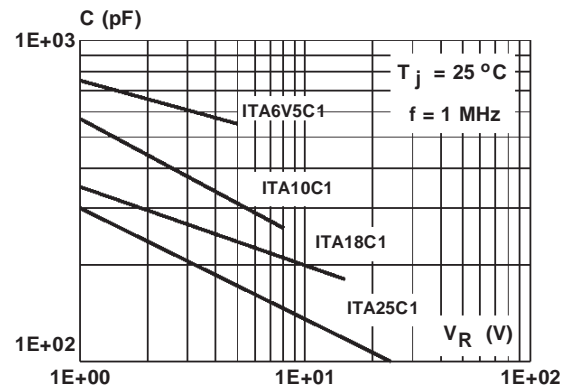

Fig.4 : Junction capacitance versus reverse applied voltage for one input/output (typical values).



Note :

The curve of the figure 2 is specified for a junction temperature of 25°C before surge.

APPLICATION NOTICE

Types	Maximum differential voltage between two input pins at 25°C
	V
ITA6V5C1	6.5
ITA10C1	10
ITA18C1	18
ITA25C1	25

INSTRUCTION GUIDE

This monolithic Transil Array is based on 6 Unidirectional Transils with a common cathode and can be configured to offer 4 or 5 bidirectional functions, according to the following customer application.

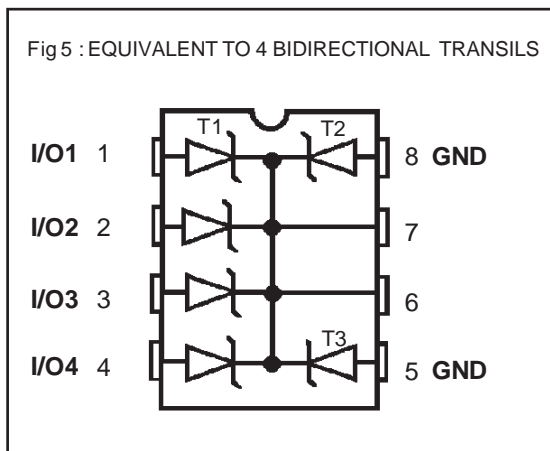

UTILIZATION AS A BIDIRECTIONAL TRANSIL ARRAY WITH 4 I/Os.

The main application of this device is to be configured as a 4, bidirectional Transil Array as per the Pin-out of Fig 5.

Pins 5 and 8 are connected to ground.

INPUTS/OUTPUTS are from Pin 1 to Pin 4.

Note : The bidirectional function is made with 2 unidirectional Transils. One (T1) is connected to the INPUT/OUTPUT, the other one (T2) is connected to the ground (see Fig 5).

Ground is connected via 2 diodes T2 and T3 .

This allows to withstand 2 specified surges on 2 different lines at the same time.

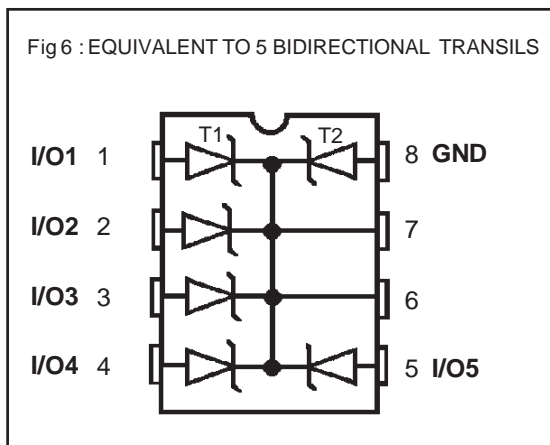

UTILIZATION AS A BIDIRECTIONAL TRANSIL ARRAY WITH 5 I/Os.

The ITAxxC1 can be used as a 5 bidirectional Transil Array.

Ground can be connected to any pin (except 6 and 7).

The other pins are used as INPUTS and OUTPUTS.

The bidirectional function is made with 2 unidirectional Transils T1 and T2. One example with ground on Pin 8 is shown in Fig 6.

This configuration allows to withstand only one specified surge at the same time.

ORDER CODE

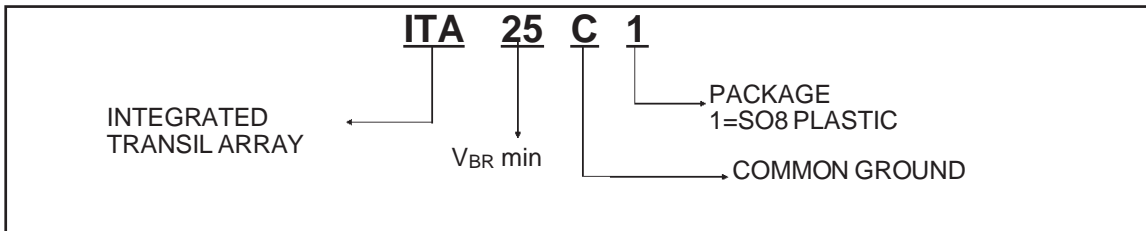

MARKING

TYPE	ITA6V5C1	ITA10C1	ITA18C1	ITA25C1
MARKING	6V5C1	10C1	18C1	25C1

PACKAGE MECHANICAL DATA
SO8

REF.	DIMENSIONS					
	Millimetres			Inches		
	Min.	Typ.	Max.	Min.	Typ.	Max.
A			1.75			0.069
a1	0.1		0.25	0.004		0.010
a2			1.65			0.065
b	0.35		0.48	0.014		0.019
b1	0.19		0.25	0.007		0.010
C		0.50			0.020	
c1	45° (typ)					
D	4.8		5.0	0.189		0.197
E	5.8		6.2	0.228		0.244
e		1.27			0.050	
e3		3.81			0.150	
F	3.8		4.0	0.15		0.157
L	0.4		1.27	0.016		0.050
M			0.6			0.024
S	8° (max)					

Weight: 0.077g

Information furnished is believed to be accurate and reliable. However, SGS-THOMSON Microelectronics assumes no responsibility for the consequences of use of such information nor for any infringement of patents or other rights of third parties which may result from its use. No license is granted by implication or otherwise under any patent or patent rights of SGS-THOMSON Microelectronics. Specifications mentioned in this publication are subject to change without notice. This publication supersedes and replaces all information previously supplied. SGS-THOMSON Microelectronics products are not authorized for use as critical components in life support devices or systems without express written approval of SGS-THOMSON Microelectronics.



© 1998 SGS-THOMSON Microelectronics - Printed in Italy - All rights reserved.

SGS-THOMSON Microelectronics GROUP OF COMPANIES

Australia - Brazil - Canada - China - France - Germany - Italy - Japan - Korea - Malaysia - Malta - Morocco
The Netherlands - Singapore - Spain - Sweden - Switzerland - Taiwan - Thailand - United Kingdom - U.S.A.

Looking for pricing, stock, or lifecycle information?

Click below to explore more details on WIN SOURCE:

-  [View 6V5C1 on WIN SOURCE](#)
-  [STMicroelectronics Information](#)

Optimize Your Supply Chain with WIN SOURCE Solutions

-  Global Sourcing Solution
-  Obsolete Management
-  Cost Control Management
-  Shortage Management
-  Alternative Solution
-  Excess Inventory Management