



THE DATASHEET OF RT9801AGE



User Programmable Micro-Power Voltage Detectors

General Description

The RT9801A/B is a micro-power voltage detector supervising the power supply voltage level for microprocessors (μP) or digital systems. It provides user programmable threshold levels with 0.1V step ranging from 1.5V to 5V, which covers most digital applications. It features low supply current of 3 μA . Selection of V_{TH} is easily achieved through 3 pins connected to GND, V_{DD} or floating for different threshold voltage settings. Two versions of threshold voltages, 1.5V to 4V and 2.5V to 5V, which are programmed in factory are offered by customer demands.

The RT9801A/B performs supervisory function by sending out a reset signal whenever the V_{DD} voltage falls below a preset threshold level. This reset signal will last the whole period before V_{DD} recovering. Reset signal will release after V_{DD} is recovered and last for the whole period of Reset Active Time-out period.

RT9801A/B is N-Channel, open-drain output and provided in SOT-23-6 package.

Ordering Information

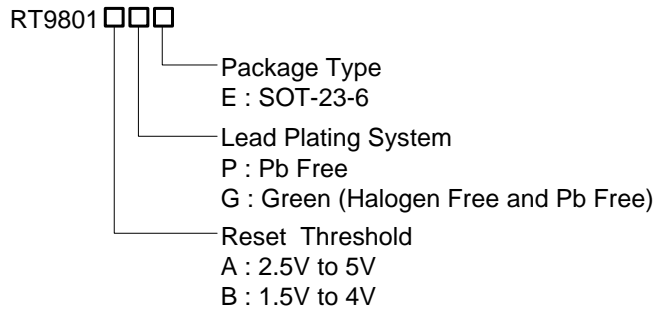

Note :

Richtek products are :

- ▶ RoHS compliant and compatible with the current requirements of IPC/JEDEC J-STD-020.
- ▶ Suitable for use in SnPb or Pb-free soldering processes.

Marking Information

For marking information, contact our sales representative directly or through a Richtek distributor located in your area.

Features

- User Programmable Threshold 1.5V to 5V in 0.1V Step with $\pm 3\%$ Accuracy
- Low Supply Current 3 μA
- Quick Reset within 20 μs
- Built-in Recovery Delay 200ms
- Low Functional Supply Voltage 0.9V
- Small SOT-23-6 Package
- RoHS Compliant and 100% Lead (Pb)-Free

Applications

- Computers
- Controllers
- Intelligent Instruments
- Critical μP and μC Power Monitoring
- Portable/Battery-Powered Equipment

Pin Configurations

(TOP VIEW)

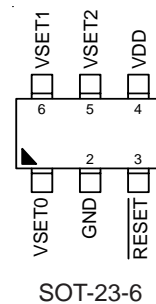

Typical Application Circuit

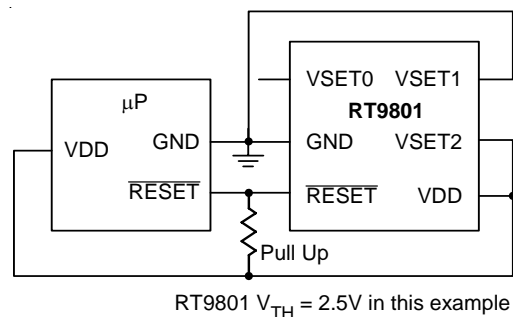

Test Circuits

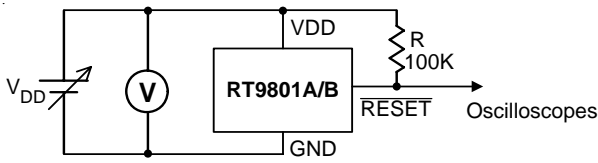

Detection Voltage

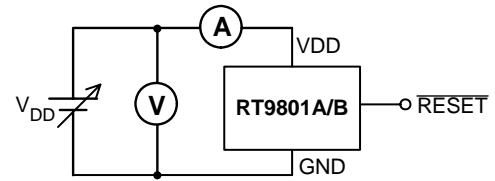

Current Consumption

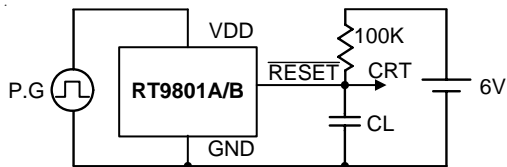

Dynamic Response

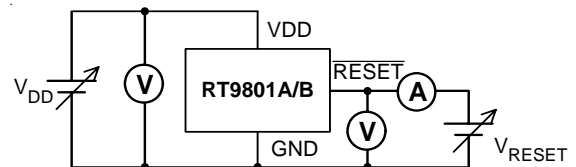

Output Transistor Current

Functional Pin Description

Pin Name	Pin Function
VSET0	Threshold Voltage Selection Pin
GND	Ground Pin
RESET	Reset Pulse Output, Negative Pulse
VDD	Power Pin
VSET1	Threshold Voltage Selection Pin
VSET2	Threshold Voltage Selection Pin

Note : Threshold Voltage Setting refer to the Table.1

Function Block Diagram

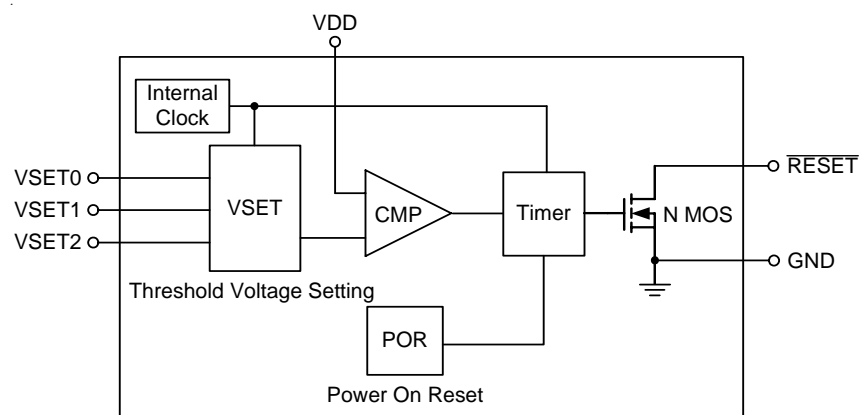

Absolute Maximum Ratings

- Terminal Voltage (with Respect to GND)
 - V_{DD} ----- -0.3V to 6.0V
 - All Other Inputs ----- -0.3V to $V_{DD}+0.3V$
- Input Current, V_{DD} ----- 20mA
- Continuous Power Dissipation, P_D @ $T_A = 25^\circ C$
 - SOT-23-6 ----- 0.25W
- Operating Junction Temperature Range ----- -40°C to 125°C
- Storage Temperature Range ----- -65°C to 125°C
- Package Thermal Resistance
 - SOT-23-6, θ_{JA} ----- 250°C /W
- Lead Temperature (Soldering, 10sec.) ----- 260°C

Electrical Characteristics

($V_{DD} = 3V$, unless otherwise specified)

Parameter	Symbol	Test Conditions	Min	Typ	Max	Unit
Operating VDD Range	V_{DD}		0.9	--	6	V
Supply Current	I_{DD}	$V_{DD} = 1.5V \sim 3.5V, I_{SINK} = 0$	--	--	3	μA
		$V_{DD} = 3.5V \sim 5V, I_{SINK} = 0$	--	--	3.3	
Reset Threshold	V_{TH}	$T_A = 27^\circ C$	--	Note1	--	V
Threshold Voltage Accuracy	ΔV_{TH}	$T_A = 27^\circ C$	--	--	3	%
V_{DD} Drop to Reset Delay	t_{RD}	Drop = -125mV	--	--	20	μs
Reset Active Timeout Period	t_{RP}	$V_{DD} \geq 1.02 \times V_{TH}$, Programmable	120	200	280	ms
VSET Pin Input Threshold	V_{IL}	$T_A = 27^\circ C$	--	$0.15V_{DD}$	--	V
	V_{IH}	$T_A = 27^\circ C$	--	$0.85V_{DD}$	--	
\overline{RESET} Output Voltage	V_{OL}	$V_{DD} < V_{TH}, I_{SINK} = 3.5mA$	--	0.4	--	V

Timing Diagram

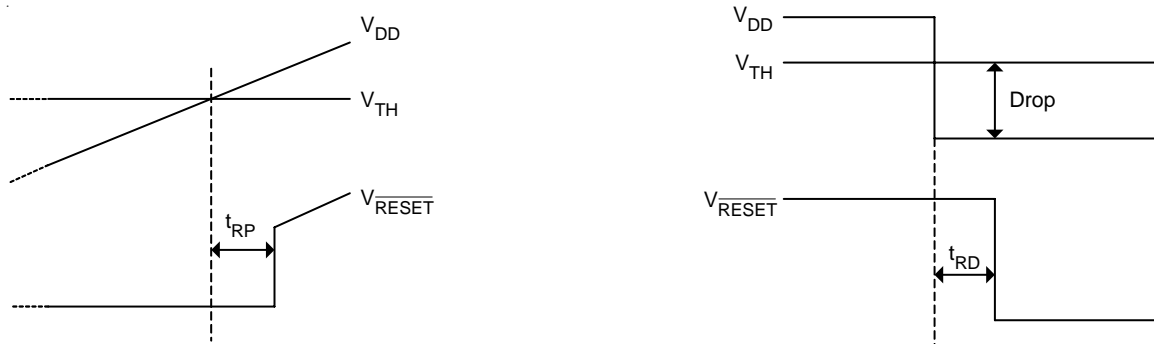
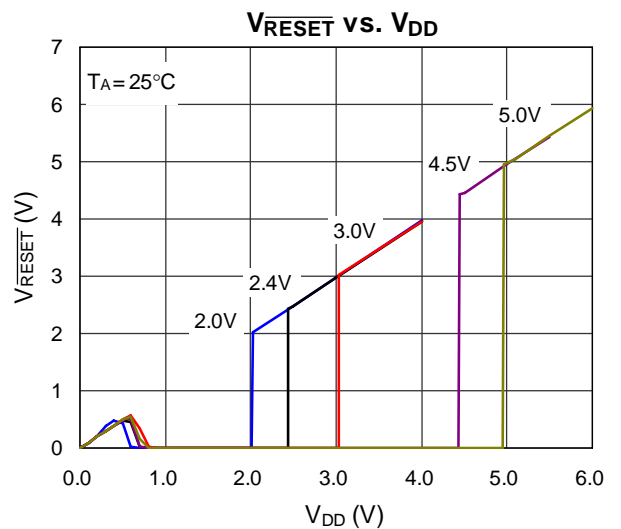
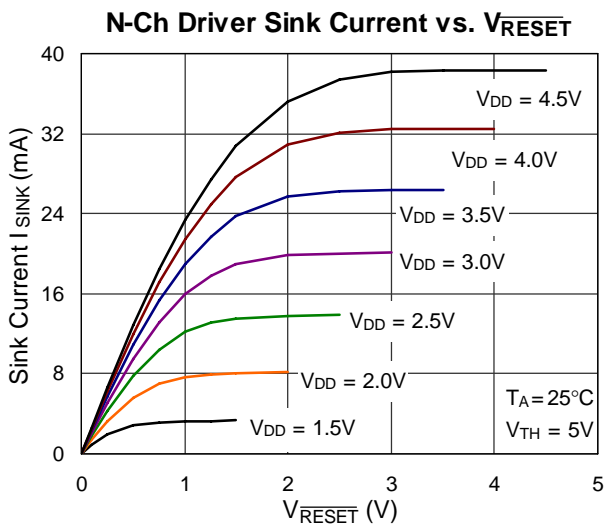
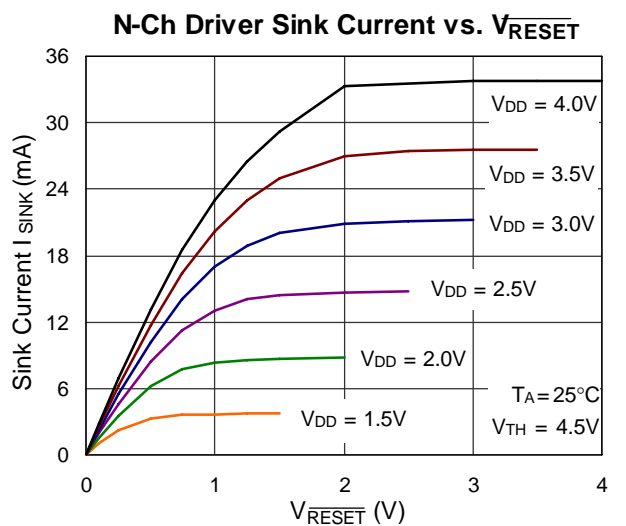
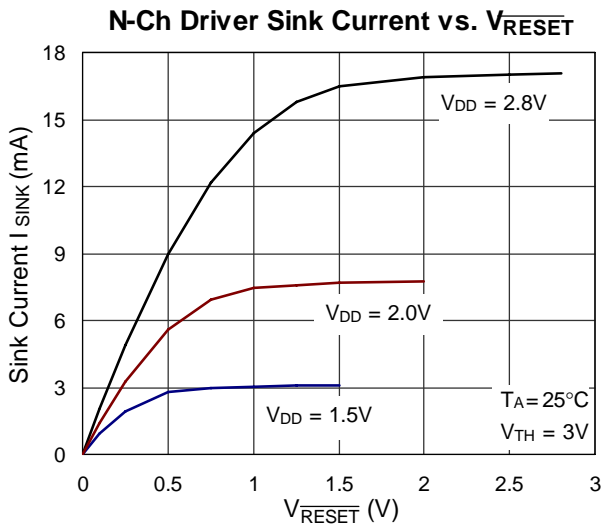
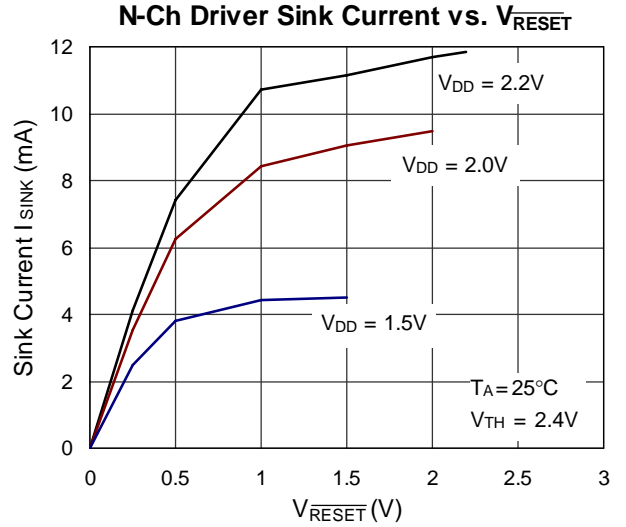
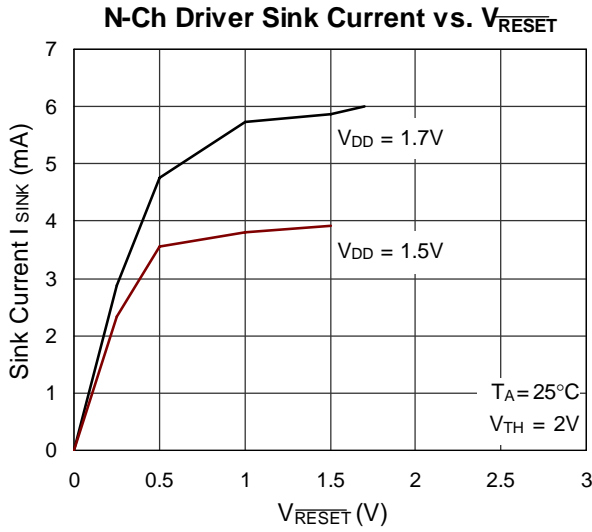

Table 1: Pin Conditions for Programmable Threshold Voltage Setting

RT9801A	RT9801B	VSET0	VSET1	VSET2
5.0	4.0	H	H	H
4.9	3.9	H	H	F
4.8	3.8	H	H	L
4.7	3.7	H	F	H
4.6	3.6	H	F	F
4.5	3.5	H	F	L
4.4	3.4	H	L	H
4.3	3.3	H	L	F
4.2	3.2	H	L	L
4.1	3.1	F	H	H
4.0	3.0	F	H	F
3.9	2.9	F	H	L
3.8	2.8	F	F	H
3.7	2.7	F	F	F
3.6	2.6	F	F	L
3.5	2.5	F	L	H
3.4	2.4	F	L	F
3.3	2.3	F	L	L
3.2	2.2	L	H	H
3.1	2.1	L	H	F
3.0	2.0	L	H	L
2.9	1.9	L	F	H
2.8	1.8	L	F	F
2.7	1.7	L	F	L
2.6	1.6	L	L	H
2.5	1.5	L	L	F

Note : 1. H : Connected to VDD
 2. L : Connected to GND
 3. F : Floating

Typical Operating Characteristics



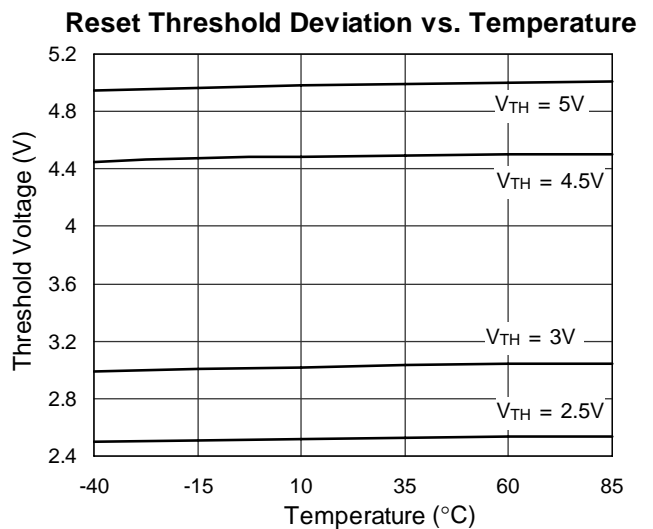
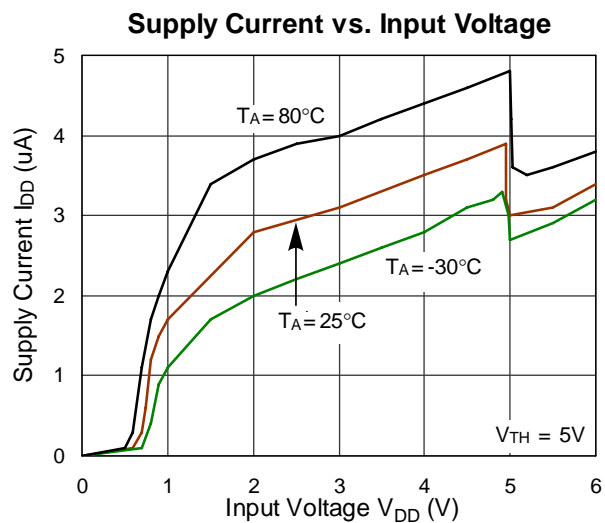
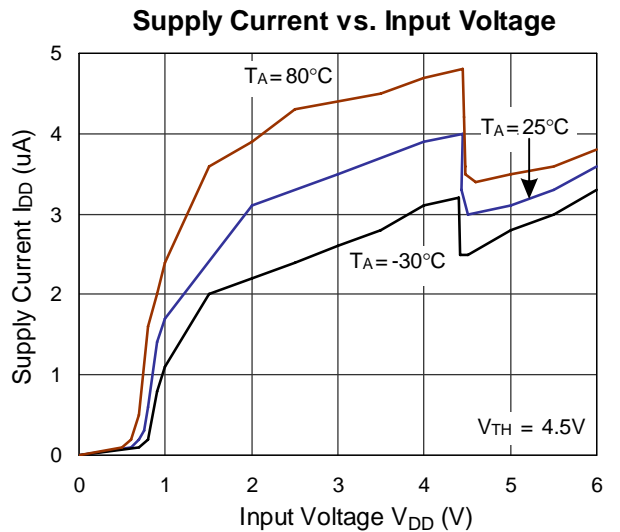
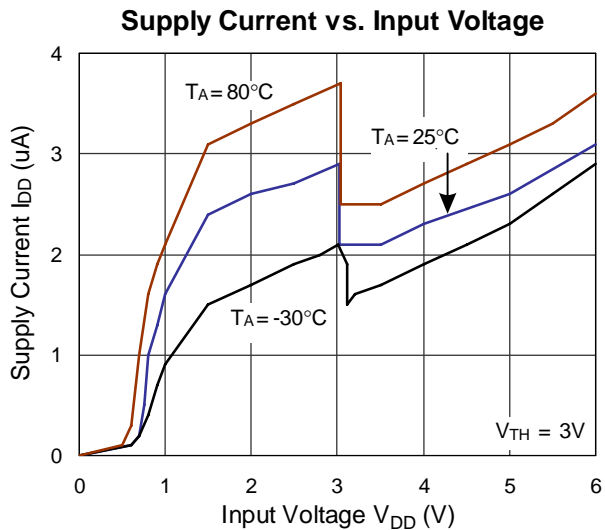
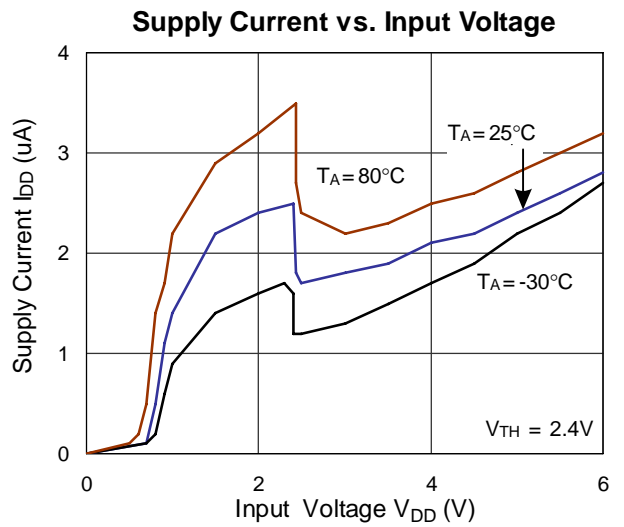
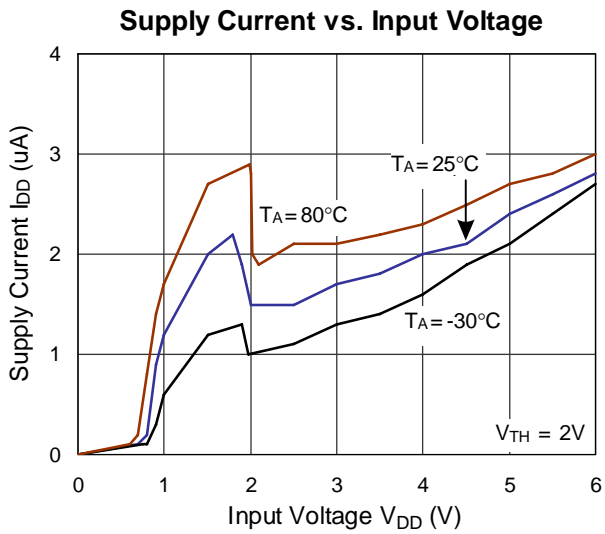

N-Ch Driver Sink Current vs. Input Voltage

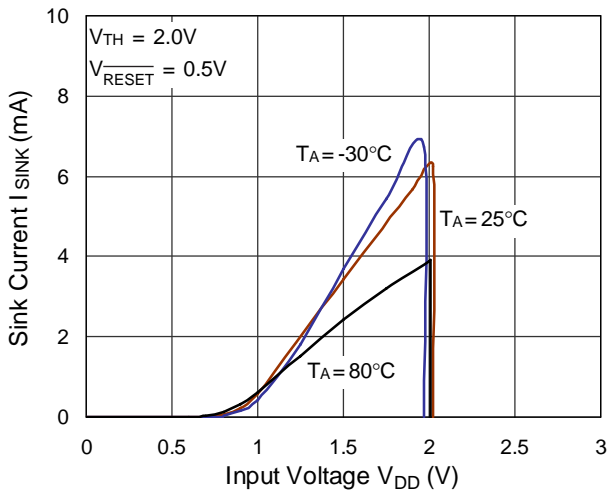

N-Ch Driver Sink Current vs. Input Voltage

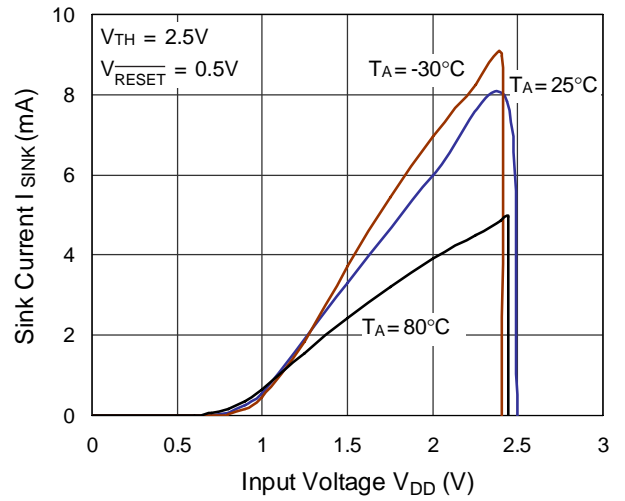

N-Ch Driver Sink Current vs. Input Voltage

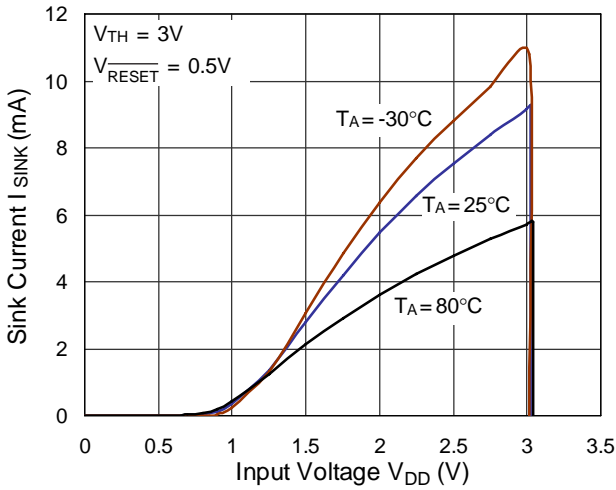

N-Ch Driver Sink Current vs. Input Voltage

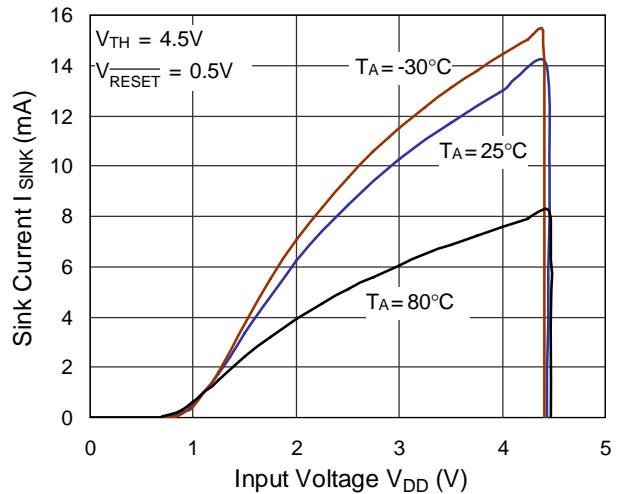

N-Ch Driver Sink Current vs. Input Voltage

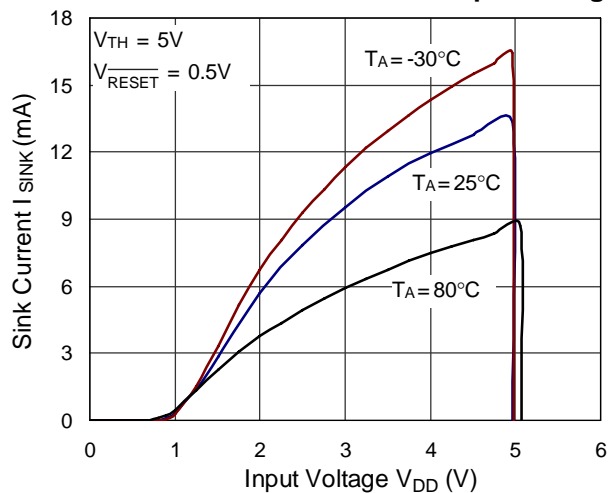

Reset Active Timeout Period vs. Temperature

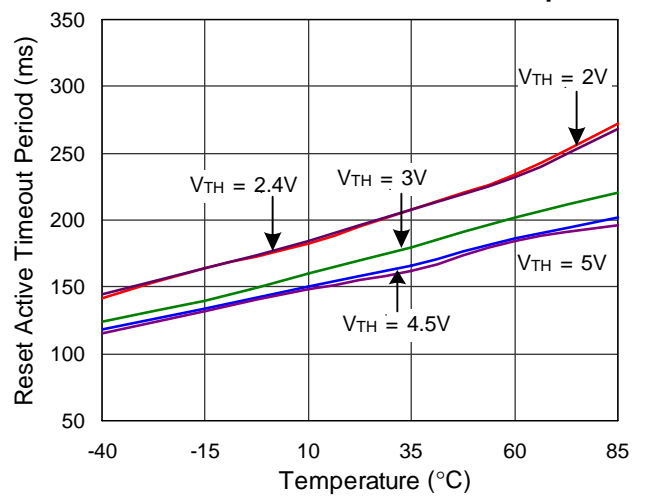

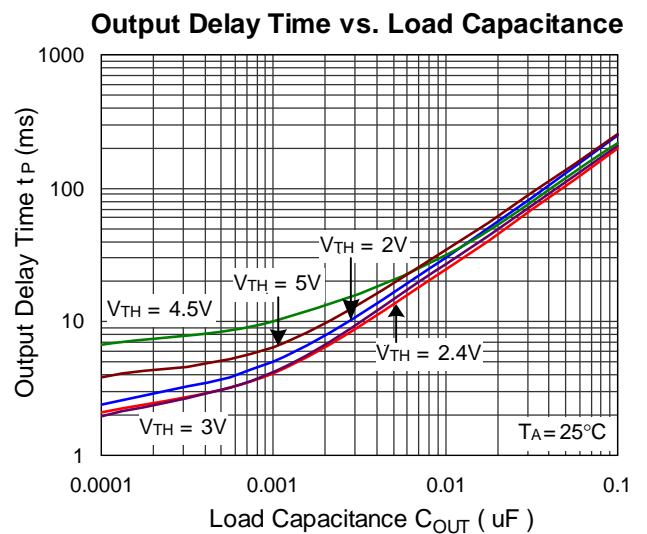
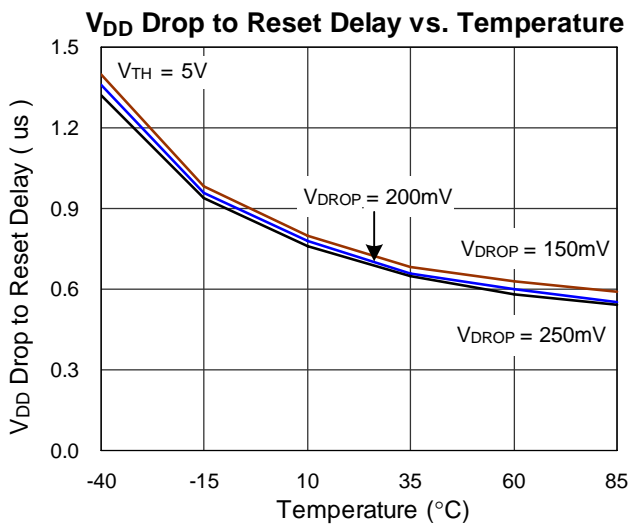
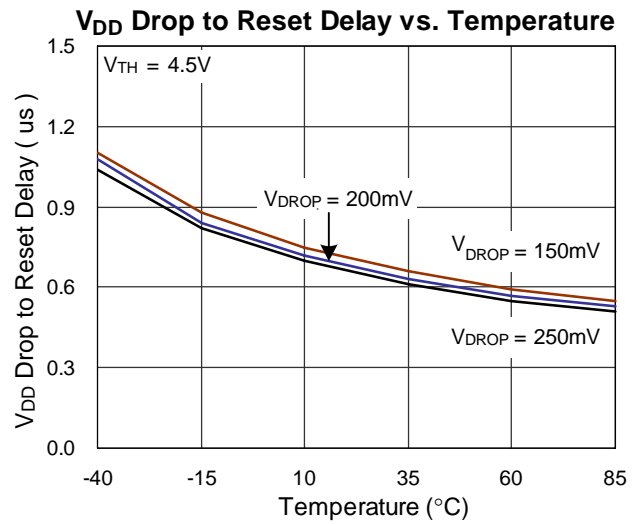
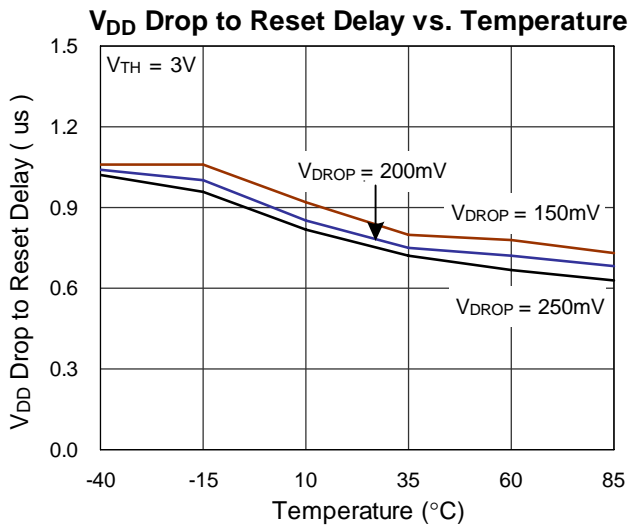
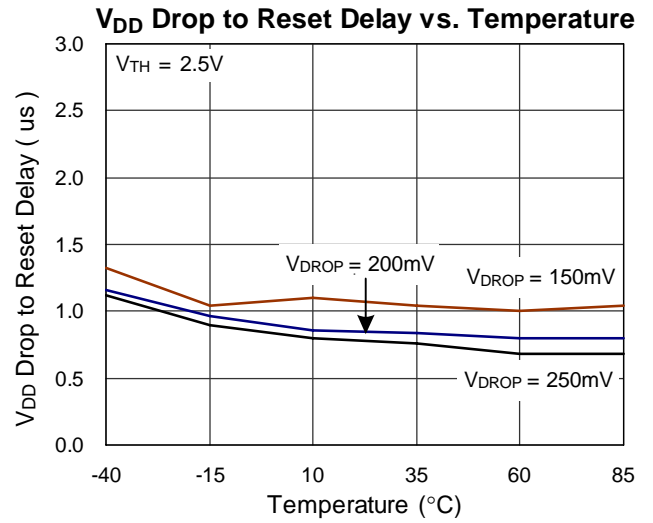
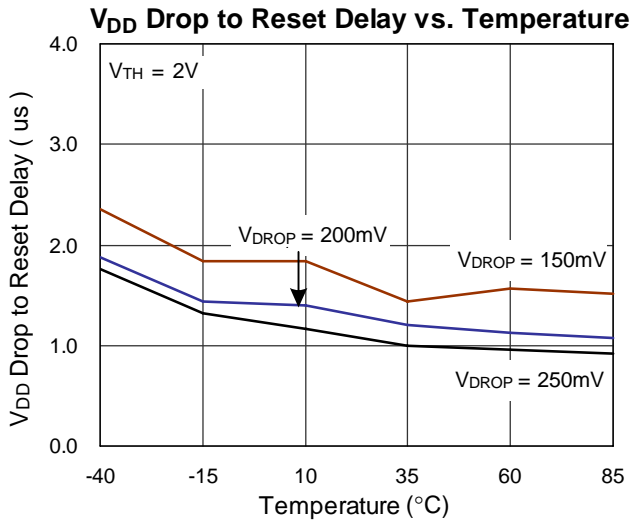

Outline Dimension

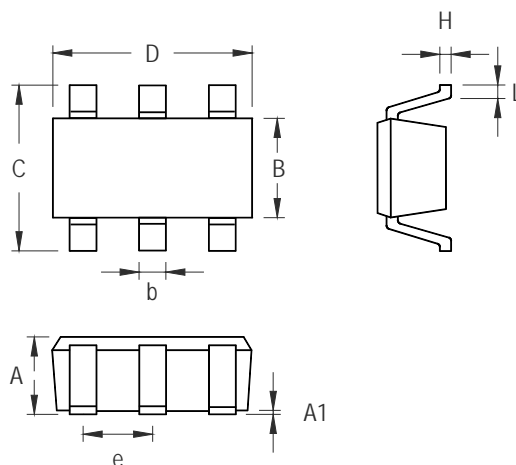

Symbol	Dimensions In Millimeters		Dimensions In Inches	
	Min	Max	Min	Max
A	0.889	1.295	0.031	0.051
A1	0.000	0.152	0.000	0.006
B	1.397	1.803	0.055	0.071
b	0.250	0.560	0.010	0.022
C	2.591	2.997	0.102	0.118
D	2.692	3.099	0.106	0.122
e	0.838	1.041	0.033	0.041
H	0.080	0.254	0.003	0.010
L	0.300	0.610	0.012	0.024

SOT-23-6 Surface Mount Package

Richtek Technology Corporation

Headquarter
 5F, No. 20, Taiyuen Street, Chupei City
 Hsinchu, Taiwan, R.O.C.
 Tel: (8863)5526789 Fax: (8863)5526611



Richtek Technology Corporation

Taipei Office (Marketing)
 5F, No. 95, Minchiuan Road, Hsintien City
 Taipei County, Taiwan, R.O.C.
 Tel: (8862)86672399 Fax: (8862)86672377
 Email: marketing@richtek.com

Information that is provided by Richtek Technology Corporation is believed to be accurate and reliable. Richtek reserves the right to make any change in circuit design, specification or other related things if necessary without notice at any time. No third party intellectual property infringement of the applications should be guaranteed by users when integrating Richtek products into any application. No legal responsibility for any said applications is assumed by Richtek.

Looking for pricing, stock, or lifecycle information?

Click below to explore more details on WIN SOURCE:

-  [View RT9801AGE on WIN SOURCE](#)
-  [Richtek USA Inc. Information](#)

Optimize Your Supply Chain with WIN SOURCE Solutions

-  Global Sourcing Solution
-  Obsolete Management
-  Cost Control Management
-  Shortage Management
-  Alternative Solution
-  Excess Inventory Management