



**THE DATASHEET OF
RT9728AHZQW**



120mΩ, 1.3A Power Switch with Programmable Current Limit

General Description

The RT9728A is a cost effective, low voltage, single P-MOSFET high-side power switch IC for USB application with a programmable current limit feature. Low switch-on resistance (typ.120mΩ) and low supply current (typ. 120μA) are realized in this IC. The RT9728A can offer a programmable current limit threshold between 75mA and 1.3A (typ.) via an external resistor. The ±10% current limit accuracy can be realized for all current limit settings. In addition, a flag output is available to indicate fault conditions to the local USB controller. Furthermore, the chip also integrates an embedded delay function to prevent mis-operation from happening due to high inrush current. The RT9728A is an ideal solution for USB power supply and can support flexible applications since it is functional for various current limit requirements. It is available in SOT-23-6 and WDFN-6L 2x2 packages.

Ordering Information

| | | | |
|---------|------------------|--|----------------------|
| RT9728A | □ | □ | □ |
| | └─ | └─ | └─ |
| | Package Type | Lead Plating System | Chip Enable |
| | E : SOT-23-6 | G : Green (Halogen Free and Pb Free) | H : Chip Enable High |
| | QW : WDFN-6L 2x2 | Z : ECO (Ecological Element with Halogen Free and Pb free) | L : Chip Enable Low |

Note :

Richtek products are :

- ▶ RoHS compliant and compatible with the current requirements of IPC/JEDEC J-STD-020.
- ▶ Suitable for use in SnPb or Pb-free soldering processes.

Features

- ±10% Current Limit Accuracy @ 1.3A
- Adjustable Current Limit : 75mA to 1.3A (typ.)
- Meets USB Current Limiting Requirements
- Operating Voltage Range : 2.5V to 5.5V
- Reverse Input–Output Voltage Protection
- Built-in Soft-Start
- 120mΩ High-Side MOSFET
- 120μA Supply Current
- RoHS Compliant and Halogen Free

Applications

- USB Bus/Self Powered Hubs
- USB Peripheral Ports
- ACPI Power Distribution
- Battery Power Equipment
- 3G/3.5G Data Card, Set-Top Boxes

Pin Configuration

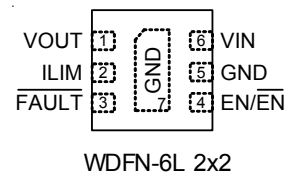
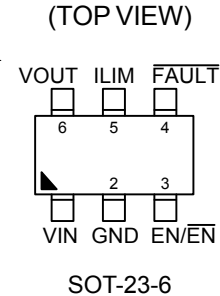

Marking Information

RT9728AHGE

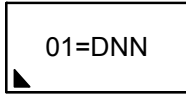

01 = : Product Code
DNN : Date Code

RT9728ALGE

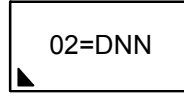

02 = : Product Code
DNN : Date Code

RT9728AHGQW

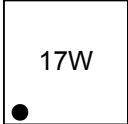

17 : Product Code
W : Date Code

RT9728ALGQW

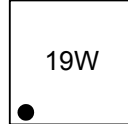

19 : Product Code
W : Date Code

RT9728AHZQW

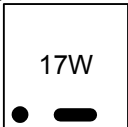

17 : Product Code
W : Date Code

RT9728ALZQW

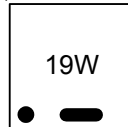

19 : Product Code
W : Date Code

Typical Application Circuit

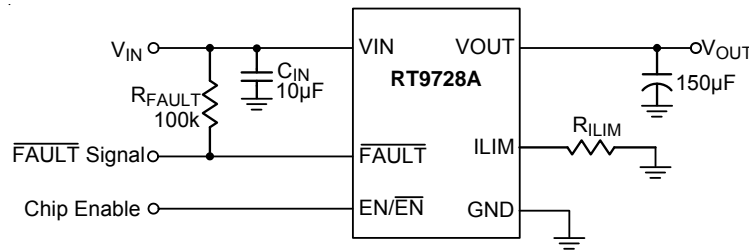

Functional Pin Description

| Pin No. | | Pin Name | Pin Function |
|----------|-----------------------|----------------------------|--|
| SOT-23-6 | WDFN-6L 2x2 | | |
| 1 | 6 | VIN | Input voltage. |
| 2 | 5, 7 (Exposed Pad) | GND | Ground. The exposed pad must be soldered to a large PCB and connected to GND for maximum power dissipation. |
| 3 | 4 | EN/ $\overline{\text{EN}}$ | Chip enable. |
| 4 | 3 | $\overline{\text{FAULT}}$ | Active-low open-drain output. Asserted during over current, over temperature, or reverse-voltage conditions. |
| 5 | 2 | ILIM | Current limit set pin. External resistor used to set current limit threshold. Recommend $19.1\text{k}\Omega \leq R_{\text{ILIM}} \leq 232\text{k}\Omega$. |
| 6 | 1 | VOUT | Power switch output. |

Functional Block Diagram

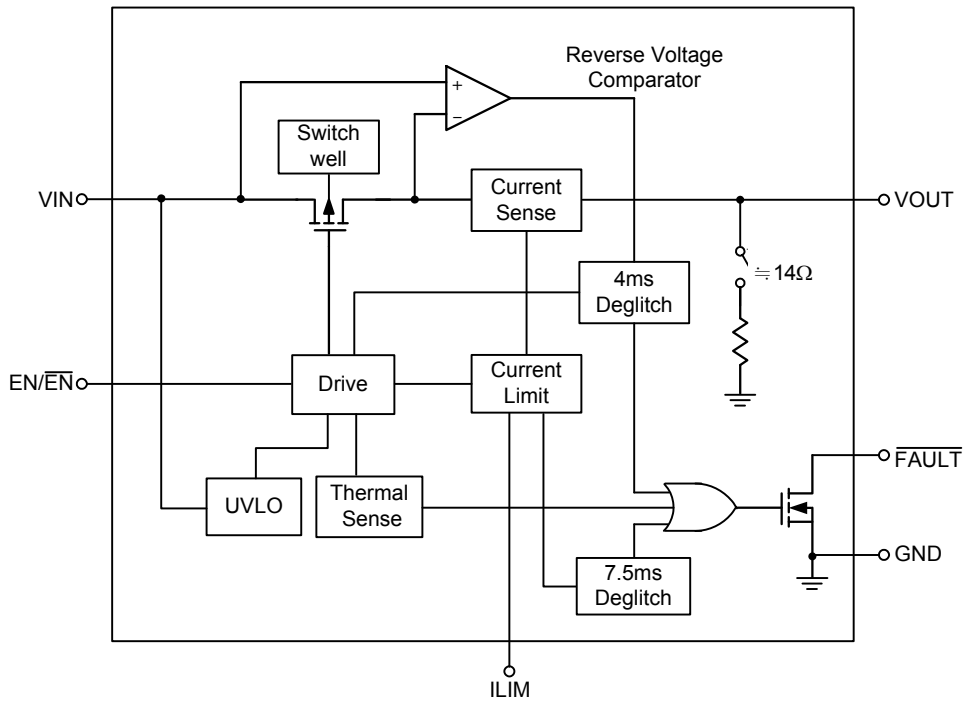

Absolute Maximum Ratings (Note 1)

- Supply Input Voltage ----- -0.3V to 6V
- Other Pin Voltage ----- -0.3V to 6V
- Power Dissipation, P_D @ $T_A = 25^\circ\text{C}$
 - SOT-23-6 ----- 0.4W
 - WDFN-6L 2x2 ----- 0.606W
- Package Thermal Resistance (Note 2)
 - SOT-23-6, θ_{JA} ----- 250°C/W
 - WDFN-6L 2x2, θ_{JA} ----- 165°C/W
 - WDFN-6L 2x2, θ_{JC} ----- 7°C/W
- Lead Temperature (Soldering, 10 sec.) ----- 260°C
- Junction Temperature ----- 150°C
- Storage Temperature Range ----- -65°C to 150°C
- ESD Susceptibility (Note 3)
 - HBM (Human Body Model) ----- 2kV

Recommended Operating Conditions (Note 4)

- Supply Input Voltage, V_{IN} ----- 2.5V to 5.5V
- Junction Temperature Range ----- -40°C to 125°C
- Ambient Temperature Range ----- -40°C to 85°C

Electrical Characteristics

($V_{IN} = 3.6\text{V}$, $19.1\text{k}\Omega \leq R_{ILIM} \leq 232\text{k}\Omega$, $T_A = 25^\circ\text{C}$, unless otherwise specified)

| Parameter | | Symbol | Test Conditions | Min | Typ | Max | Unit | |
|---|------------|--------------|--|--------------------------------|------|------|------------------|---------------|
| EN Input Voltage | Logic-High | V_{IH} | | 1.1 | -- | -- | V | |
| | Logic-Low | V_{IL} | | -- | -- | 0.66 | | |
| Current Limit Threshold Resistor Range | | R_{ILIM} | (nominal 1%) from I_{LIM} to GND | 19.1 | -- | 232 | k Ω | |
| Under Voltage Lockout Threshold | | V_{UVLO} | V_{IN} rising | -- | 2.3 | -- | V | |
| | | | V_{IN} falling | -- | 2.1 | -- | | |
| Shutdown Current | | I_{SHDN} | $V_{IN} = 5.5\text{V}$, no load on V_{OUT} , $V_{EN} = 0\text{V}$ | -- | 1 | 3 | μA | |
| Quiescent Current | | I_Q | $V_{IN} = 5.5\text{V}$, no load on V_{OUT} | $R_{ILIM} = 20\text{k}\Omega$ | -- | 120 | 170 | μA |
| | | | | $R_{ILIM} = 210\text{k}\Omega$ | -- | 120 | 170 | |
| Reverse Leakage Current | | I_{REV} | $V_{OUT} = 5.5\text{V}$, $V_{IN} = 0\text{V}$ | -- | 1 | 3 | μA | |
| Thermal Shutdown Temperature | | T_{SD} | | -- | 160 | -- | $^\circ\text{C}$ | |
| Static Drain-Source On-State Resistance | | $R_{DS(ON)}$ | $I_{SW} = 0.2\text{A}$ | -- | 120 | -- | m Ω | |
| Current Limit | | I_{LIM} | $R_{ILIM} = 20\text{k}\Omega$ | 1190 | 1295 | 1400 | mA | |
| | | | $R_{ILIM} = 49.9\text{k}\Omega$ | 468 | 520 | 572 | | |
| | | | $R_{ILIM} = 210\text{k}\Omega$ | 110 | 130 | 150 | | |
| | | | I_{LIM} shorted to V_{IN} | 50 | 75 | 100 | | |

| Parameter | Symbol | Test Conditions | Min | Typ | Max | Unit |
|--|----------|---|-----|-----|-----|---------|
| Reverse Voltage Comparator Trip Point ($V_{OUT} - V_{IN}$) | | | -- | 135 | -- | mV |
| \overline{FAULT} Output Low Voltage | V_{OL} | $I_{FAULT} = 1mA$ | -- | 180 | -- | mV |
| \overline{FAULT} Off State Leakage | | $V_{FAULT} = 5.5V$ | -- | 1 | -- | μA |
| \overline{FAULT} Deglitch | | \overline{FAULT} assertion or de-assertion due to over current condition | 5 | 7.5 | 10 | ms |
| | | \overline{FAULT} assertion or de-assertion due to reverse voltage condition | 2 | 4 | 6 | |

Note 1. Stresses beyond those listed under “Absolute Maximum Ratings” may cause permanent damage to the device. These are stress ratings only, and functional operation of the device at these or any other conditions beyond those indicated in the operational sections of the specifications is not implied. Exposure to absolute maximum rating conditions may affect device reliability.

Note 2. θ_{JA} is measured at $T_A = 25^\circ C$ on a low effective thermal conductivity single-layer test board per JEDEC 51-3. θ_{JC} is measured at the exposed pad of the package.

Note 3. Devices are ESD sensitive. Handling precaution is recommended.

Note 4. The device is not guaranteed to function outside its operating conditions.

Typical Operating Characteristics

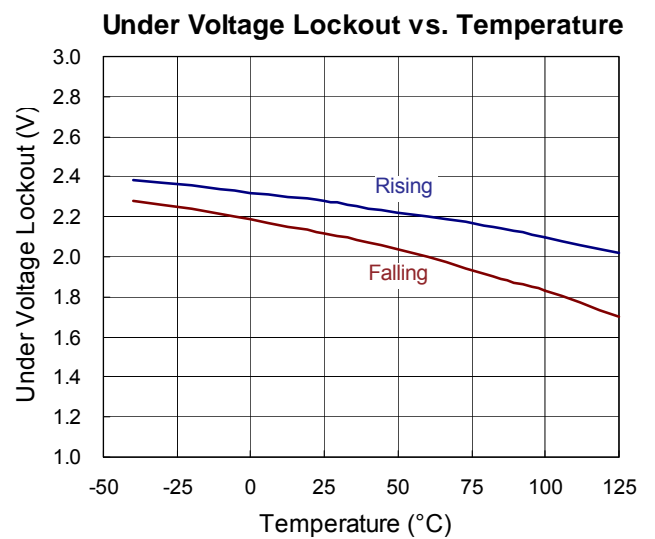
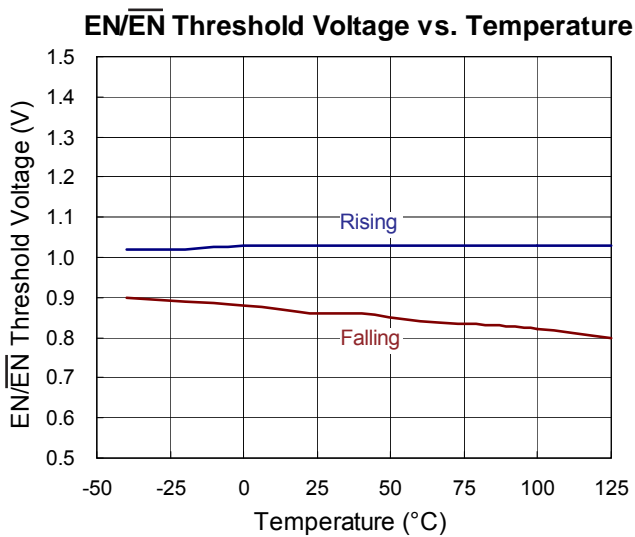
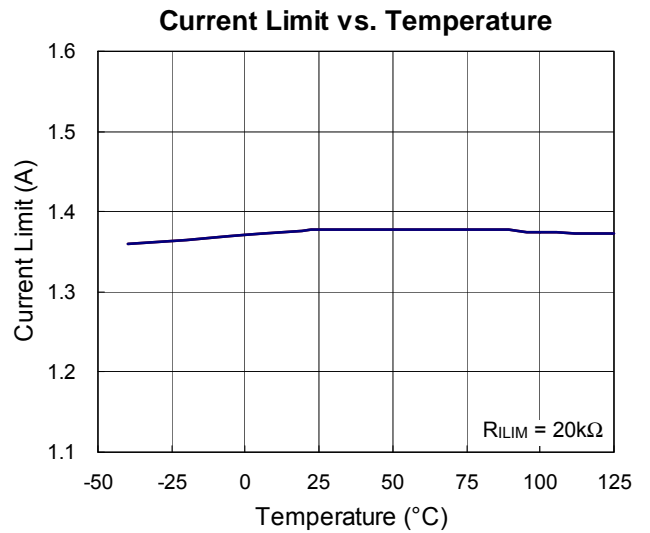
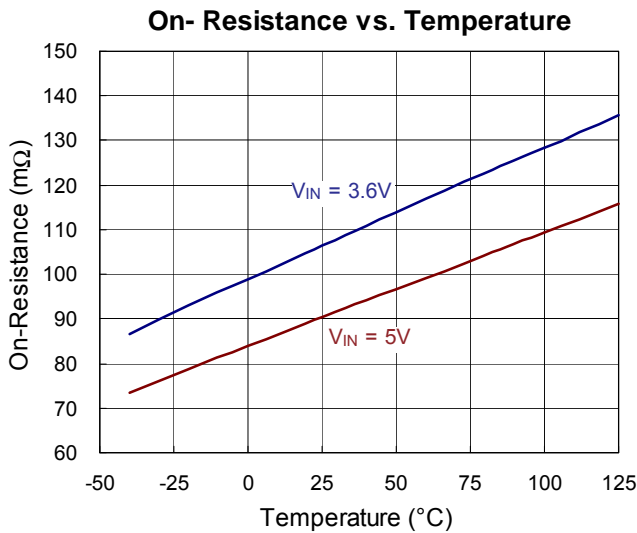
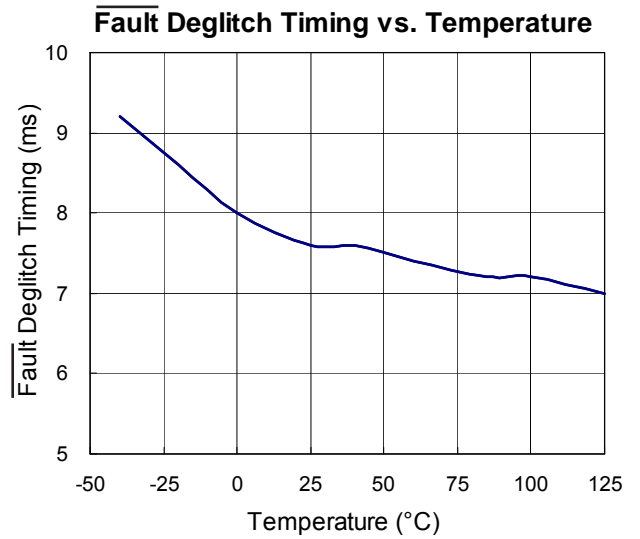
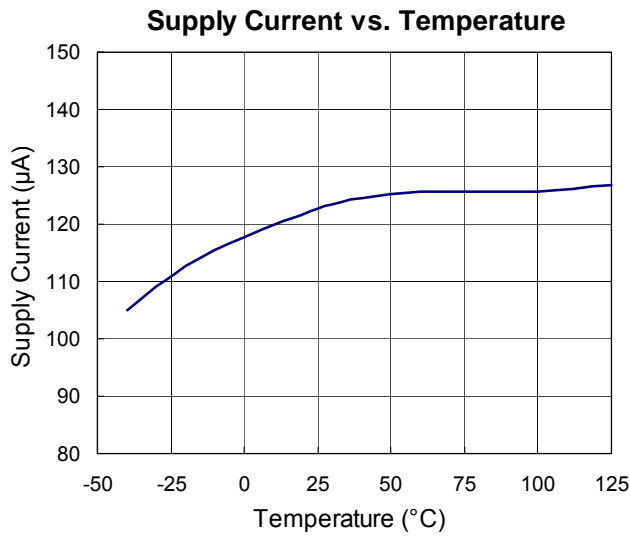

Power On from EN

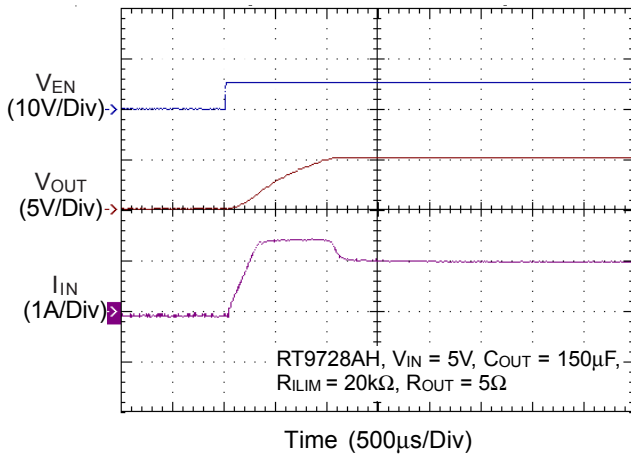

Power Off from EN

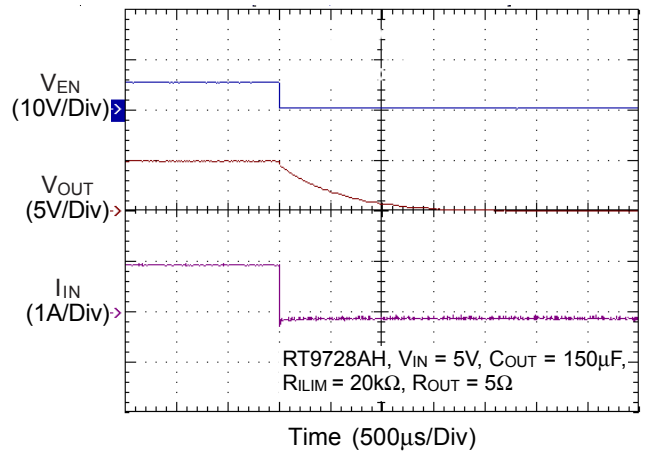

Power On from \overline{EN}

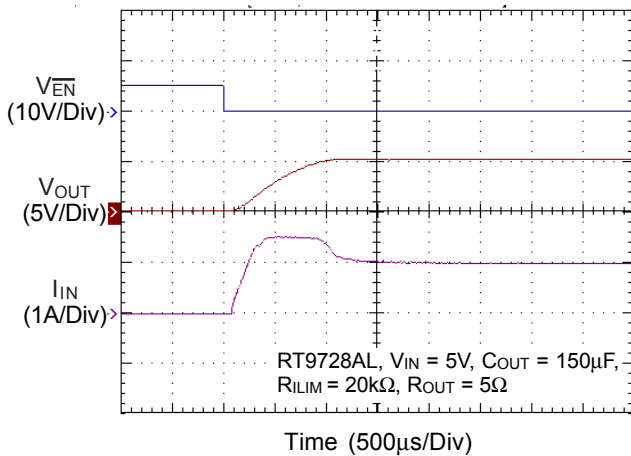

Power Off from \overline{EN}

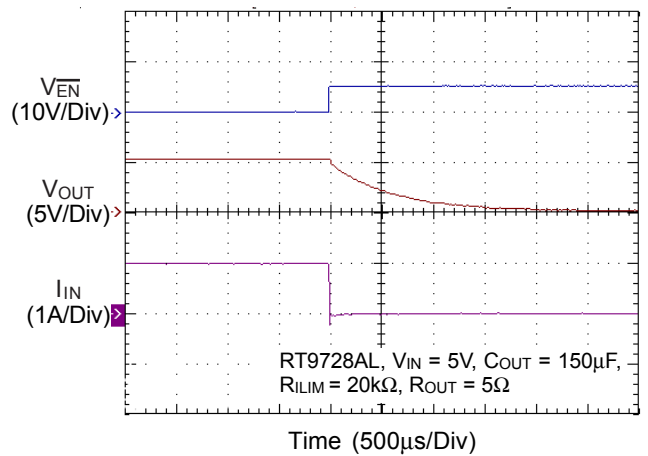

Current Limit

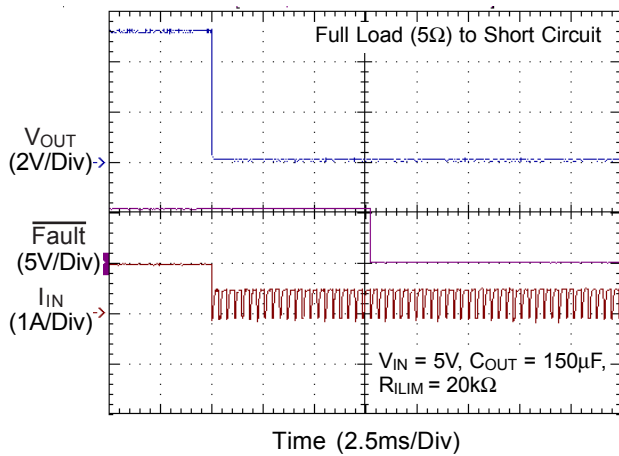

Current Limit

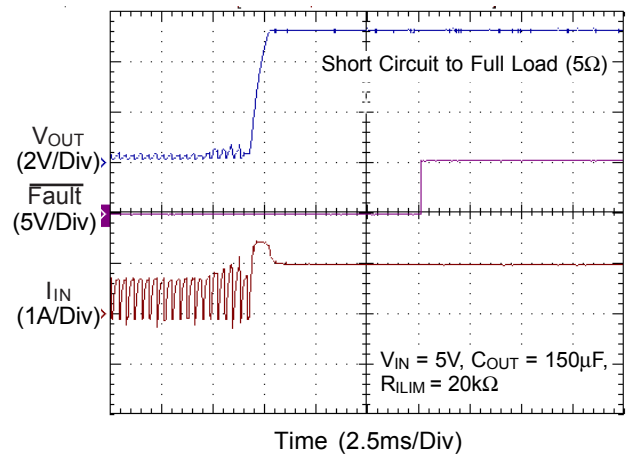

Current Limit

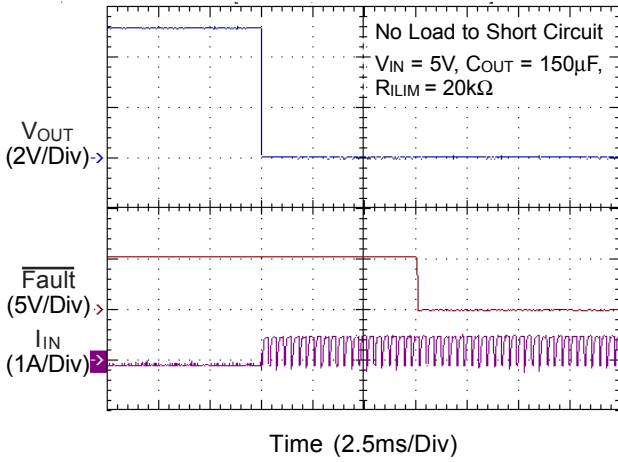

Current Limit

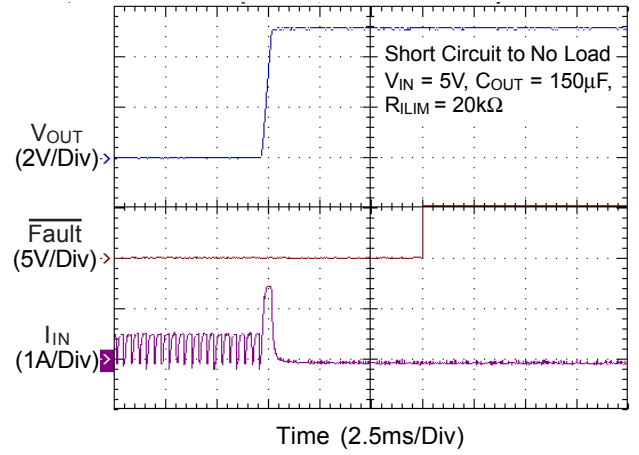

Static Drain-Source Current vs. $V_{IN} - V_{OUT}$

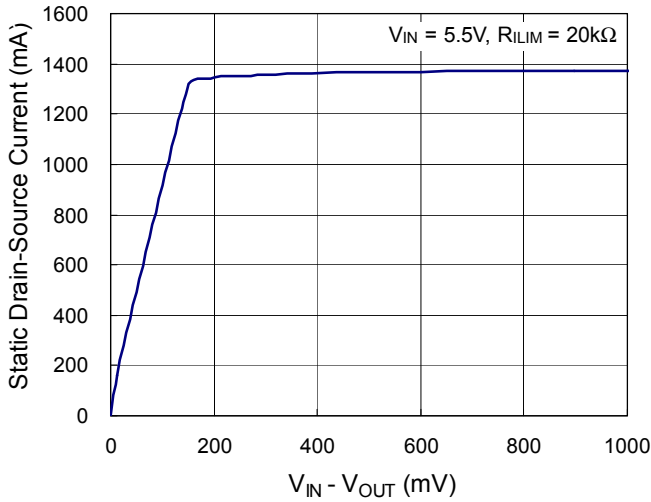

Static Drain-Source Current vs. $V_{IN} - V_{OUT}$

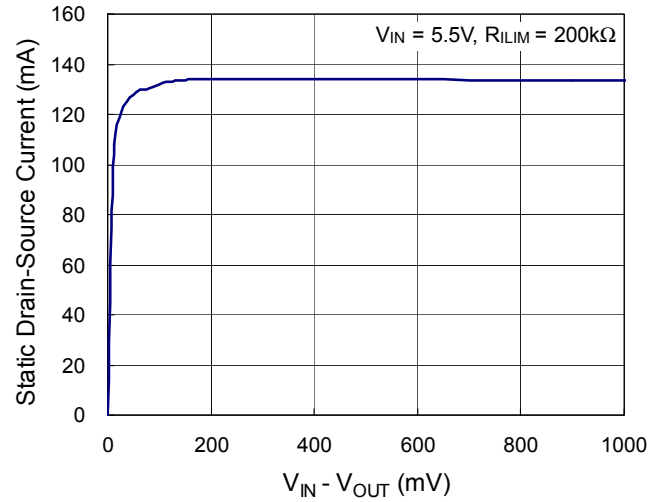

Applications Information

The RT9728A is a single P-MOSFET high-side power switch with active-high/low enable input, optimized for self-powered and bus-powered Universal Serial Bus (USB) applications. The switch's low $R_{DS(ON)}$ meets USB voltage drop requirements and a flag output is available to indicate fault conditions to the local USB controller.

Current Limiting and Short Circuit Protection

When a heavy load or short circuit situation occurs while the switch is enabled, large transient current may flow through the device. The RT9728A includes a current-limit circuitry to prevent these large currents from damaging the MOSFET switch and the hub downstream ports. The RT9728A provides an adjustable current limit threshold between 120mA and 1.3A (typ) via an external resistor, R_{ILIM} , between 19.1k Ω and 232k Ω . However, if the ILIM pin is connected to V_{IN} , the current limit threshold will be 75mA (typ). Once the current limit threshold is exceeded,

the device enters constant-current mode until either thermal shutdown occurs or the fault is removed. The table1 shows a recommended current limit value vs. R_{ILIM} resistor.

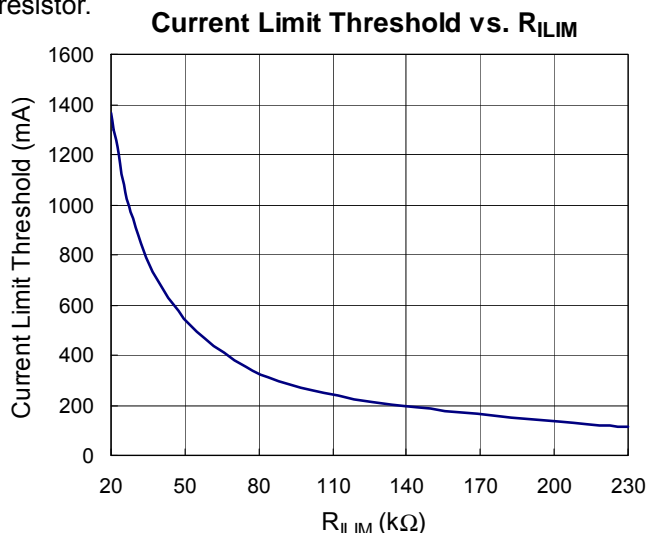

Figure 1. Current Limit Threshold vs R_{ILIM}

Table 1. Recommended R_{ILIM} Resistor Selections

| Desired Nominal Current Limit (mA) | Ideal Resistor (k Ω) | Closest 1% Resistor (k Ω) | Actual Limits (Include R Tolerance) | | |
|------------------------------------|------------------------------|-----------------------------------|-------------------------------------|--------------|--------------|
| | | | IOS Min (mA) | IOS Nom (mA) | IOS Max (mA) |
| 75 | Short ILIM to VIN | | 50.0 | 75.0 | 100.0 |
| 120 | 226.1 | 226.0 | 101.3 | 120.0 | 142.1 |
| 200 | 134.0 | 133.0 | 173.7 | 201.5 | 233.9 |
| 300 | 88.5 | 88.7 | 262.1 | 299.4 | 342.3 |
| 400 | 65.9 | 66.5 | 351.1 | 396.7 | 448.7 |
| 500 | 52.5 | 52.3 | 443.9 | 501.6 | 562.4 |
| 600 | 43.5 | 43.2 | 535.1 | 604.6 | 674.1 |
| 700 | 37.2 | 37.4 | 616.0 | 696.0 | 776.0 |
| 800 | 32.4 | 32.4 | 708.7 | 800.8 | 892.9 |
| 900 | 28.7 | 28.7 | 797.8 | 901.5 | 1005.2 |
| 1000 | 25.8 | 26.1 | 875.4 | 989.1 | 1102.8 |
| 1100 | 23.4 | 23.2 | 982.1 | 1109.7 | 1237.3 |
| 1200 | 21.4 | 21.5 | 1057.9 | 1195.4 | 1332.9 |
| 1300 | 19.7 | 19.6 | 1178.0 | 1308.5 | 1439.0 |

Fault Flag

The RT9728A provides a $\overline{\text{FAULT}}$ signal pin which is an N-channel open drain MOSFET output. This open drain output goes low when current exceeds current limit threshold, $V_{\text{OUT}} - V_{\text{IN}}$ exceeds reverse voltage trip level, or the die temperature exceeds 160°C approximately. The $\overline{\text{FAULT}}$ output is capable of sinking a 1mA load to typically 180mV above ground. The $\overline{\text{FAULT}}$ pin requires a pull-up resistor; this resistor should be large in value to reduce energy drain. A 100kΩ pull-up resistor works well for most applications. In case of an over current condition, $\overline{\text{FAULT}}$ will be asserted only after the flag response delay time, t_{D} , has elapsed. This ensures that $\overline{\text{FAULT}}$ is asserted upon valid over current conditions and that erroneous error reporting is eliminated. For example, false over current conditions may occur during hot-plug events when extremely large capacitive loads are connected, which induces a high transient inrush current that exceeds the current limit threshold. The $\overline{\text{FAULT}}$ response delay time, t_{D} , is typically 7.5ms.

Supply Filter/Bypass Capacitor

A 10μF low ESR ceramic capacitor connected from V_{IN} to GND and located close to the device is strongly recommended to prevent input voltage drooping during hot-plug events. However, higher capacitor values may be used to further reduce the voltage droop on the input. Without this bypass capacitor, an output short may cause sufficient ringing on the input (from source lead inductance) to destroy the internal control circuitry. Note that the input transient voltage must never exceed 6V as stated in the Absolute Maximum Ratings.

Output Filter Capacitor

A low ESR 150μF aluminum electrolytic capacitor connected between V_{OUT} and GND is strongly recommended to meet the USB standard maximum droop requirement for the hub, VBUS. Standard bypass methods should be used to minimize inductance and resistance between the bypass capacitor and the downstream connector to reduce EMI and decouple voltage droop caused by hot-insertion transients in downstream cables. Ferrite beads in series with VBUS, the ground line and the 0.1μF bypass capacitors at the power connector pins

are recommended for EMI and ESD protection. The bypass capacitor itself should have a low dissipation factor to allow decoupling at higher frequencies.

Chip Enable Input

The RT9728AH/L will be disabled when the $\text{EN}/\overline{\text{EN}}$ pin is in a logic-low/high condition. During this condition, the internal circuitry and MOSFET are turned off, reducing the supply current to 1μA typical. The maximum guaranteed voltage for a logic-low at the $\text{EN}/\overline{\text{EN}}$ pin is 0.66V. A minimum guaranteed voltage of 1.1V at the $\text{EN}/\overline{\text{EN}}$ pin will turn off the RT9728A. Floating the input may cause unpredictable operation. $\text{EN}/\overline{\text{EN}}$ should not be allowed to go negative with respect to GND.

Under Voltage Lockout

Under voltage lockout (UVLO) prevents the MOSFET switch from turning on until input voltage exceeds approximately 2.3V. If input voltage drops below approximately 2.1V, UVLO turns off the MOSFET switch.

Thermal Considerations

For continuous operation, do not exceed absolute maximum junction temperature. The maximum power dissipation depends on the thermal resistance of the IC package, PCB layout, rate of surrounding airflow, and difference between junction and ambient temperature. The maximum power dissipation can be calculated by the following formula :

$$P_{\text{D(MAX)}} = (T_{\text{J(MAX)}} - T_{\text{A}}) / \theta_{\text{JA}}$$

where $T_{\text{J(MAX)}}$ is the maximum junction temperature, T_{A} is the ambient temperature, and θ_{JA} is the junction to ambient thermal resistance.

For recommended operating condition specifications, the maximum junction temperature is 125°C. The junction to ambient thermal resistance, θ_{JA} , is layout dependent. For SOT-23-6 packages, the thermal resistance, θ_{JA} , is 250°C/W on a standard JEDEC 51-3 single-layer thermal test board. For WDFN-6L 2x2 packages, the thermal resistance, θ_{JA} , is 165°C/W on a standard JEDEC 51-3 single-layer thermal test board. The maximum power dissipation at $T_{\text{A}} = 25^{\circ}\text{C}$ can be calculated by the following formula :

$P_{D(MAX)} = (125^{\circ}\text{C} - 25^{\circ}\text{C}) / (250^{\circ}\text{C/W}) = 0.400\text{W}$ for SOT-23-6 package

$P_{D(MAX)} = (125^{\circ}\text{C} - 25^{\circ}\text{C}) / (165^{\circ}\text{C/W}) = 0.606\text{W}$ for WDFN-6L 2x2 package

The maximum power dissipation depends on the operating ambient temperature for fixed $T_{J(MAX)}$ and thermal resistance, θ_{JA} . The derating curves in Figure 2 allow the designer to see the effect of rising ambient temperature on the maximum power dissipation.

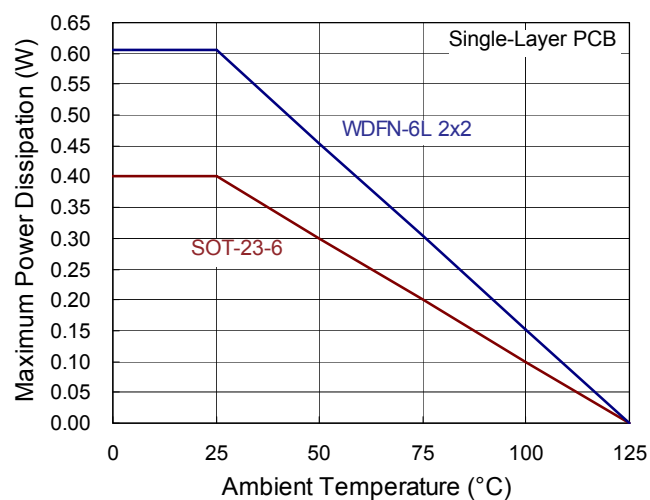
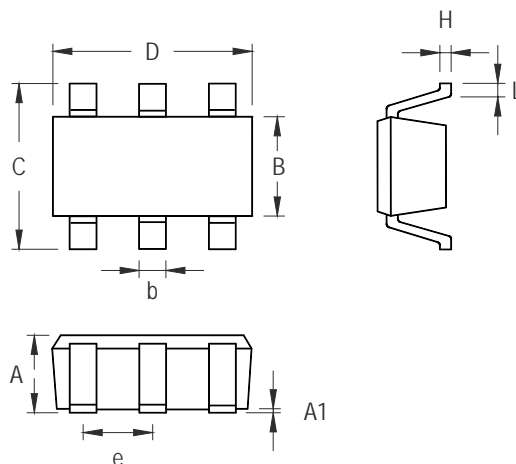

Figure 2. Derating Curve of Maximum Power Dissipation

Outline Dimension



| Symbol | Dimensions In Millimeters | | Dimensions In Inches | |
|--------|---------------------------|-------|----------------------|-------|
| | Min | Max | Min | Max |
| A | 0.889 | 1.295 | 0.031 | 0.051 |
| A1 | 0.000 | 0.152 | 0.000 | 0.006 |
| B | 1.397 | 1.803 | 0.055 | 0.071 |
| b | 0.250 | 0.560 | 0.010 | 0.022 |
| C | 2.591 | 2.997 | 0.102 | 0.118 |
| D | 2.692 | 3.099 | 0.106 | 0.122 |
| e | 0.838 | 1.041 | 0.033 | 0.041 |
| H | 0.080 | 0.254 | 0.003 | 0.010 |
| L | 0.300 | 0.610 | 0.012 | 0.024 |

SOT-23-6 Surface Mount Package

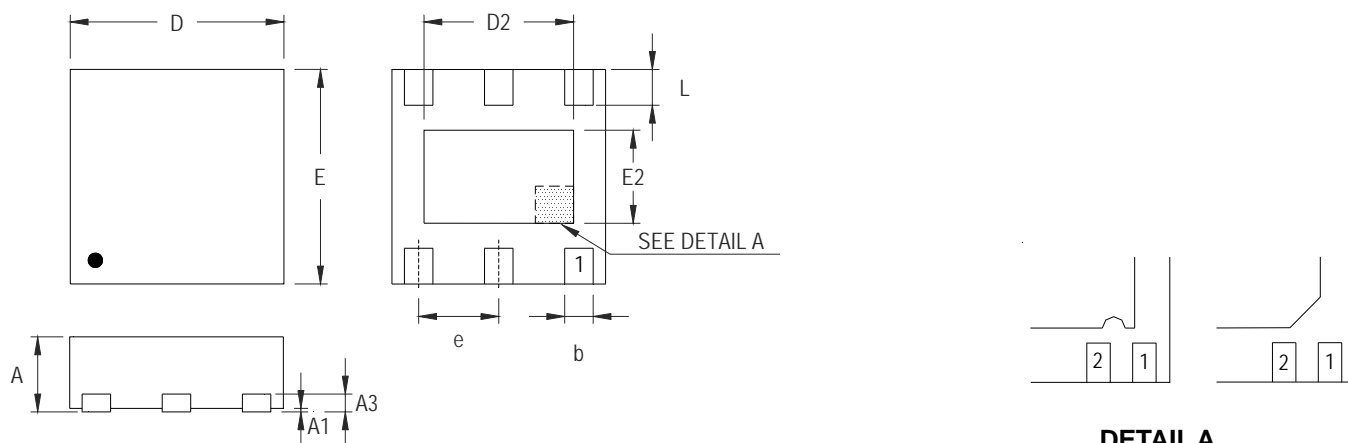

DETAIL A

Pin #1 ID and Tie Bar Mark Options

Note : The configuration of the Pin #1 identifier is optional, but must be located within the zone indicated.

| Symbol | Dimensions In Millimeters | | Dimensions In Inches | |
|--------|---------------------------|-------|----------------------|-------|
| | Min | Max | Min | Max |
| A | 0.700 | 0.800 | 0.028 | 0.031 |
| A1 | 0.000 | 0.050 | 0.000 | 0.002 |
| A3 | 0.175 | 0.250 | 0.007 | 0.010 |
| b | 0.200 | 0.350 | 0.008 | 0.014 |
| D | 1.950 | 2.050 | 0.077 | 0.081 |
| D2 | 1.000 | 1.450 | 0.039 | 0.057 |
| E | 1.950 | 2.050 | 0.077 | 0.081 |
| E2 | 0.500 | 0.850 | 0.020 | 0.033 |
| e | 0.650 | | 0.026 | |
| L | 0.300 | 0.400 | 0.012 | 0.016 |

W-Type 6L DFN 2x2 Package



Richtek Technology Corporation

14F, No. 8, Tai Yuen 1st Street, Chupei City
 Hsinchu, Taiwan, R.O.C.
 Tel: (8863)5526789

Richtek products are sold by description only. Customers should obtain the latest relevant information and data sheets before placing orders and should verify that such information is current and complete. Richtek cannot assume responsibility for use of any circuitry other than circuitry entirely embodied in a Richtek product. Information furnished by Richtek is believed to be accurate and reliable. However, no responsibility is assumed by Richtek or its subsidiaries for its use; nor for any infringements of patents or other rights of third parties which may result from its use. No license is granted by implication or otherwise under any patent or patent rights of Richtek or its subsidiaries.

Looking for pricing, stock, or lifecycle information?

Click below to explore more details on WIN SOURCE:

-  [View RT9728AHZQW on WIN SOURCE](#)
-  [Richtek USA Inc. Information](#)

Optimize Your Supply Chain with WIN SOURCE Solutions

-  Global Sourcing Solution
-  Obsolete Management
-  Cost Control Management
-  Shortage Management
-  Alternative Solution
-  Excess Inventory Management