



**THE DATASHEET OF  
RT8569GQW**



## 6 Strings 43V White LED Driver

### General Description

The RT8569 is a high efficiency driver for white LEDs. It is designed for LCD panels that employ an array of LEDs as the lighting source. An integrated current mode boost controller drives six strings in parallel and support up-to 12 WLEDs per string. The internal current sinks support a maximum of  $\pm 2\%$  current mismatching for excellent brightness uniformity in each string of LEDs. To provide enough headroom for current sink operation, the boost controller monitors the minimum voltage of the feedback pins and regulates an optimized output voltage for power efficiency.

The RT8569 has a wide input voltage range from 4.2V to 24V and can provide adjustable LED current from 5mA to 40mA. The internal 200m $\Omega$ , 43V power switch with current-mode control provides cycle-by-cycle over current protection. The RT8569 also integrates PWM dimming function for accurate LED current control. The input PWM dimming frequency can operate from 200Hz to 25kHz without inducing any inrush in LED current or inductor current. The switching frequency of the RT8569 is also adjustable from 500kHz to 2MHz, which allows flexibility between efficiency and component size.

The RT8569 is available in a thin WQFN-20L 4x4 package.

### Ordering Information

RT8569

- Package Type  
QW : WQFN-20L 4x4 (W-Type)  
(Exposed Pad-Option 2)
- Lead Plating System  
G : Green (Halogen Free and Pb Free)

Note :

Richtek products are :

- ▶ RoHS compliant and compatible with the current requirements of IPC/JEDEC J-STD-020.
- ▶ Suitable for use in SnPb or Pb-free soldering processes.

### Marking Information

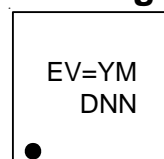

EV= : Product Code  
YMDNN : Date Code

### Features

- Wide Input Voltage : 4.2V to 24V
- High Output Voltage : Up to 43V
- Programmable Channel Current : 5mA to 40mA
- Channel Current Regulation with Accuracy  $\pm 3\%$  and Matching  $\pm 2\%$
- Dimming Controls : External PWM Input Up to 25 kHz
- Adjustable Switching Frequency : 500kHz to 2MHz
- Build-In Soft-Start
- Protections
  - ▶ LED Strings Open Detection
  - ▶ Current Limit Protection
  - ▶ Programmable Over Voltage Protection
  - ▶ Over Temperature Protection
- 20-Lead WQFN Package
- RoHS Compliant and Halogen Free

### Applications

- UMPC and Notebook Computer Backlight
- GPS, Portable DVD Backlight

### Pin Configurations

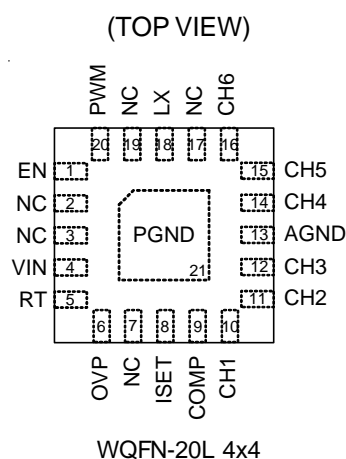

Typical Application Circuit

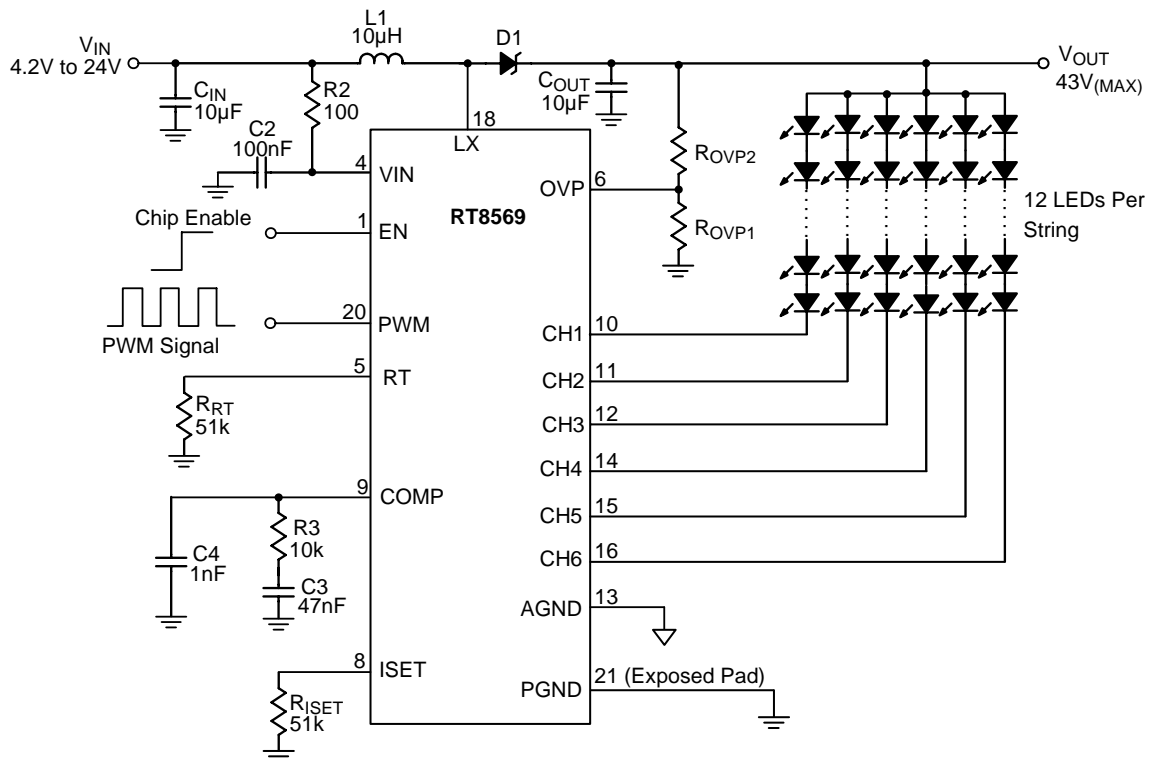

Functional Pin Description

Pin No.	Pin Name	Pin Function
1	EN	Chip Enable (Active High). Note that the pull-low current is typically 3µA.
2, 3, 7, 17, 19	NC	No Internal Connection.
4	VIN	Supply Input.
5	RT	Frequency Set. Connect a resistor to ground to set the switching frequency of the boost converter.
6	OVP	Over Voltage Protection. The detecting threshold is 1.2V.
8	ISET	LED Current Set. LED current is set by the value of the resistor RISET connected from the ISET pin to ground. Do NOT short the ISET pin to ground. VISET is typically 1V.
9	COMP	Compensation for Error Amplifier. Connect a compensation network to ground.
10, 11, 12, 14, 15, 16	CH1 to CH6	Current Sink for LED. (Leave the pin unconnected, if not used)
13	AGND	Analog Ground of LED Driver.
18	LX	Switching.
20	PWM	PWM Dimming Control Input.
21 (Exposed pad)	PGND	Power Ground. The exposed pad must be soldered to a large PCB and connected to GND for maximum power dissipation.

**Function Block Diagram**

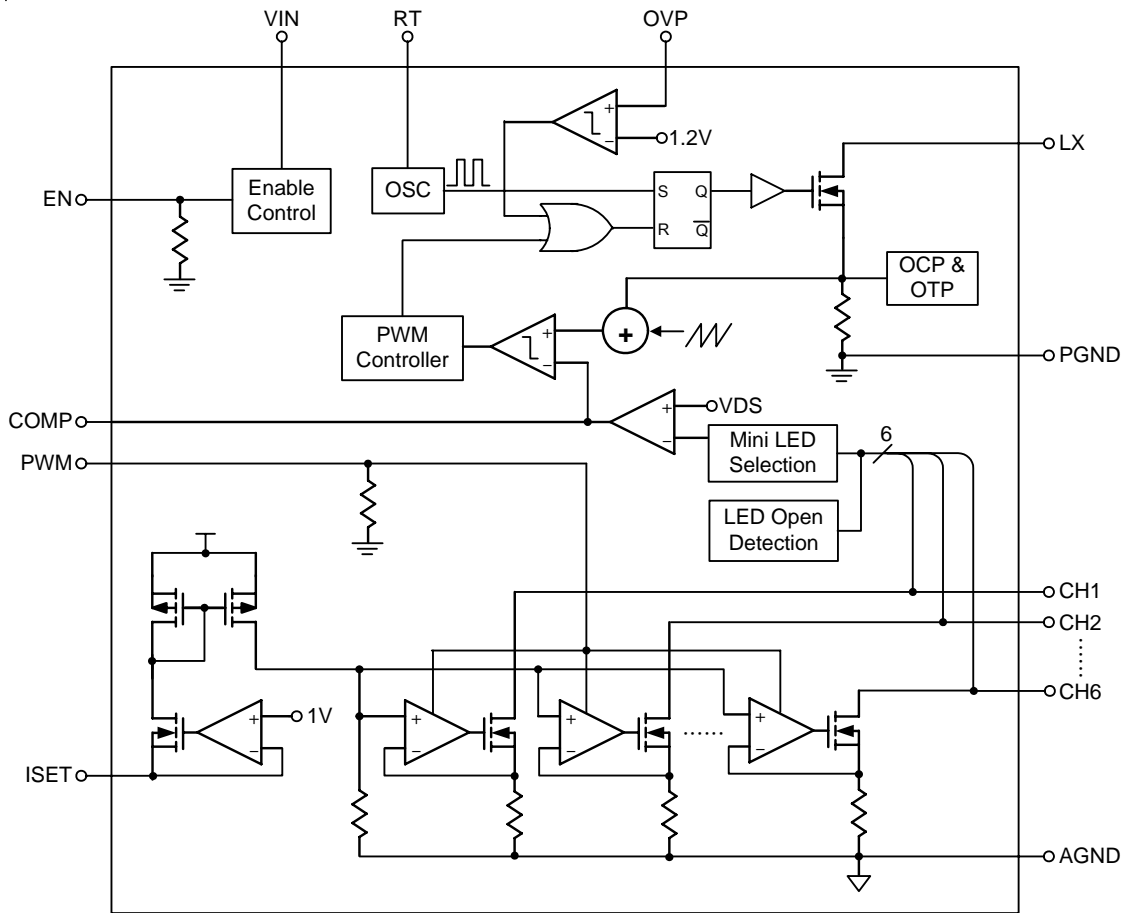

**Absolute Maximum Ratings** (Note 1)

- VIN to GND ----- -0.3V to 26.5V
- EN, PWM, ISET, COMP, RT to GND ----- -0.3V to 26.5V
- LX to GND ----- -0.3V to 48V
- OVP, (CH1 to CH6) to GND ----- -0.3V to 48V
- Power Dissipation, P<sub>D</sub> @ T<sub>A</sub> = 25°C  
 WQFN-20L 4x4 ----- 1.852W
- Package Thermal Resistance (Note 2)  
 WQFN-20L 4x4, θ<sub>JA</sub> ----- 54°C/W  
 WQFN-20L 4x4, θ<sub>JC</sub> ----- 7°C/W
- Lead Temperature (Soldering, 10 sec.) ----- 260°C
- Junction Temperature ----- 150°C
- Storage Temperature Range ----- -65°C to 150°C

**Recommended Operating Conditions** (Note 3)

- Supply Input Voltage, V<sub>IN</sub> ----- 4.2V to 24V
- Junction Temperature ----- -40°C to 125°C
- Ambient Temperature Range ----- -40°C to 85°C

**Electrical Characteristics**

(V<sub>IN</sub> = 4.5V, T<sub>A</sub> = 25°C, unless otherwise specified)

Parameter	Symbol	Test Conditions	Min	Typ	Max	Unit
<b>System Supply</b>						
VIN Under Voltage Lockout Threshold	V <sub>UVLO</sub>	V <sub>IN</sub> Rising	--	3.8	--	V
Under Voltage Lockout Hysteresis			--	0.2	--	V
VIN Quiescent Current	I <sub>VCC</sub>	V <sub>COMP</sub> = 0V, No Switching	--	1	2	mA
	I <sub>VCC_LX</sub>	V <sub>COMP</sub> = 2V, Switching	--	2	3	
Shutdown Current	I <sub>SHDN</sub>	V <sub>IN</sub> = 4.5V, V <sub>EN</sub> ≤ 0.8V	--	--	10	μA
EN, PWM Input Voltage Threshold	Logic-High	V <sub>IH</sub>	V <sub>IN</sub> = 4.2V to 24V	2	--	V
	Logic-Low	V <sub>IL</sub>	V <sub>IN</sub> = 4.2V to 24V	--	0.8	
<b>LED Current Programming</b>						
LED Current Accuracy	I <sub>LEDA</sub>	2V > V <sub>CHx</sub> > 0.6V, R <sub>ISET</sub> = 51kΩ	19.4	20	20.6	mA
LED Current Matching	I <sub>LEDM</sub>	2V > V <sub>CHx</sub> > 0.6V, R <sub>ISET</sub> = 51kΩ, Calculated by $\frac{(I_{LEDX} - I_{AVG})}{I_{AVG}} \times 100\%$	--	±0.5	±2	%
ISET Pin Voltage	V <sub>ISET</sub>		--	1	--	V
<b>PWM Boost Converter</b>						
Switching Frequency	f <sub>OSC</sub>	R <sub>RT</sub> = 25kΩ	--	2	--	MHz
		R <sub>RT</sub> = 51kΩ	0.9	1	1.1	
		R <sub>RT</sub> = 100kΩ	--	0.5	--	
LX On Resistance (N-MOSFET)	R <sub>DS(ON)</sub>	V <sub>IN</sub> > 4.5V	--	0.2	--	Ω

To be continued

Parameter	Symbol	Test Conditions	Min	Typ	Max	Unit
Minimum On Time	t <sub>MON</sub>	f <sub>OSC</sub> = 1MHz	--	120	--	ns
Maximum Duty	D <sub>MAX</sub>	COMP = 2V, Switching	--	94	--	%
LX Current Limit	I <sub>LIM</sub>		1.6	2	2.4	A
Regulated V <sub>CHx</sub>	V <sub>CHx</sub>	Highest LED String, I <sub>LED</sub> = 20mA	--	0.6	--	V
<b>Fault Protection</b>						
OVP Threshold	V <sub>OVP</sub>		--	1.2	--	V
OVP Fail Threshold	V <sub>OVPF</sub>		--	50	--	mV
Thermal Shutdown Temperature	T <sub>SD</sub>		--	150	--	°C
LED Pin Under Voltage Threshold	V <sub>LSD</sub>	No-connection	--	60	--	mV

**Note 1.** Stresses listed as the above "Absolute Maximum Ratings" may cause permanent damage to the device. These are for stress ratings. Functional operation of the device at these or any other conditions beyond those indicated in the operational sections of the specifications is not implied. Exposure to absolute maximum rating conditions for extended periods may remain possibility to affect device reliability.

**Note 2.** θ<sub>JA</sub> is measured in natural convection at T<sub>A</sub> = 25°C on a high effective thermal conductivity four-layer test board of JEDEC 51-7 thermal measurement standard. The measurement case position of θ<sub>JC</sub> is on the exposed pad of the package.

**Note 3.** The device is not guaranteed to function outside its operating conditions.

Typical Operating Characteristics

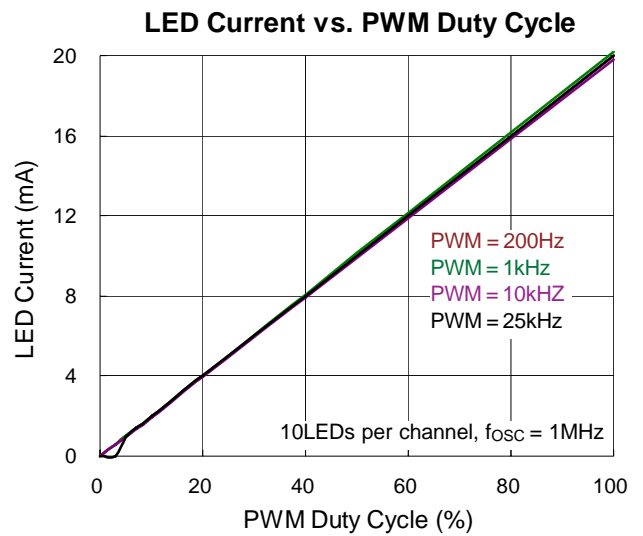
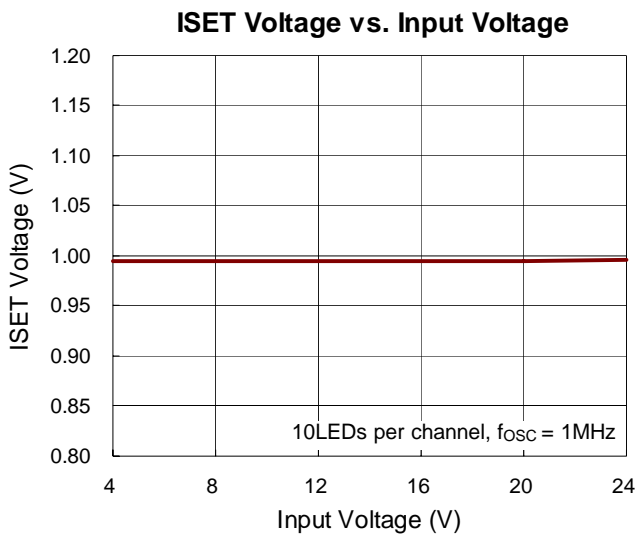
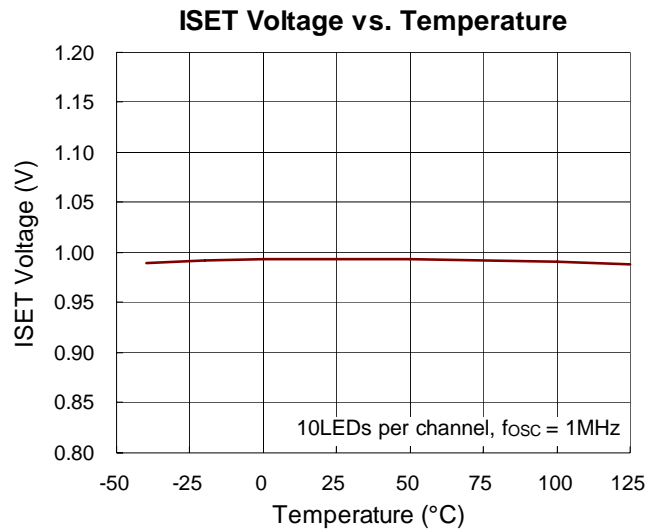
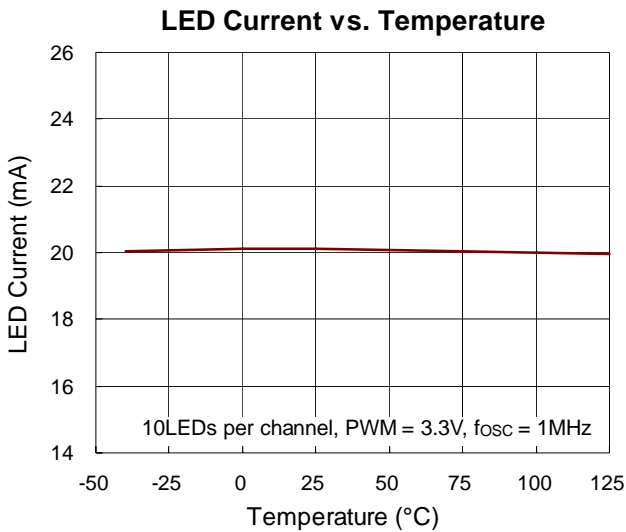
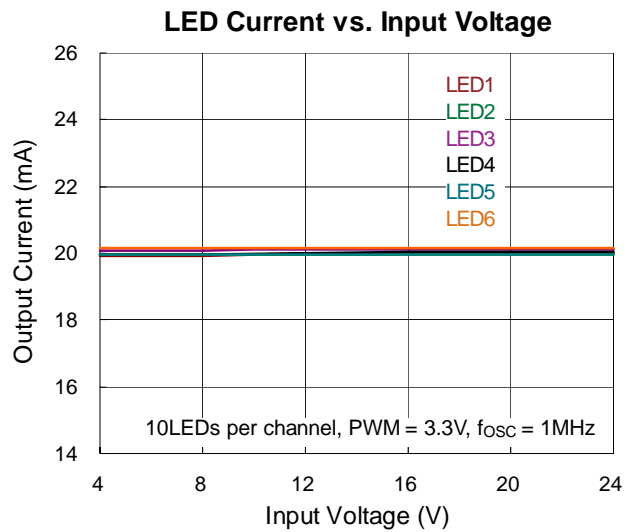
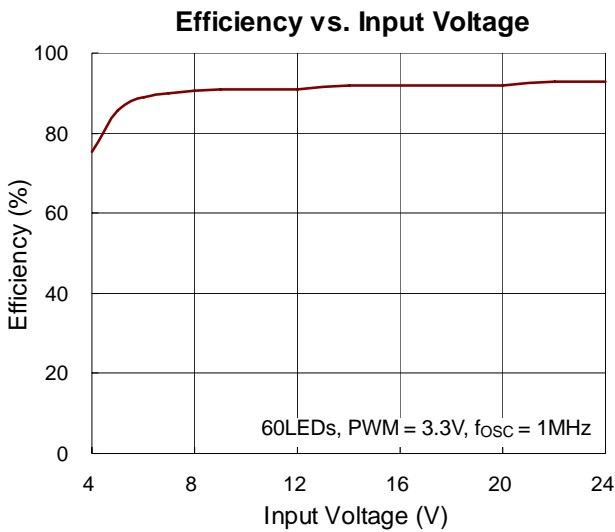

OVP Threshold Voltage vs. Input Voltage

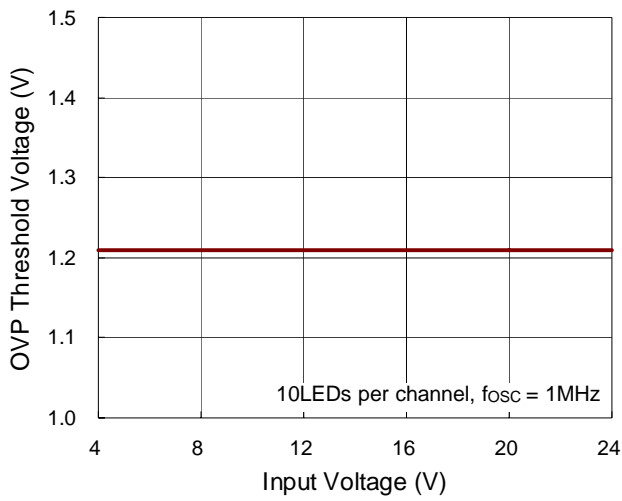

Quiescent Current vs. Temperature

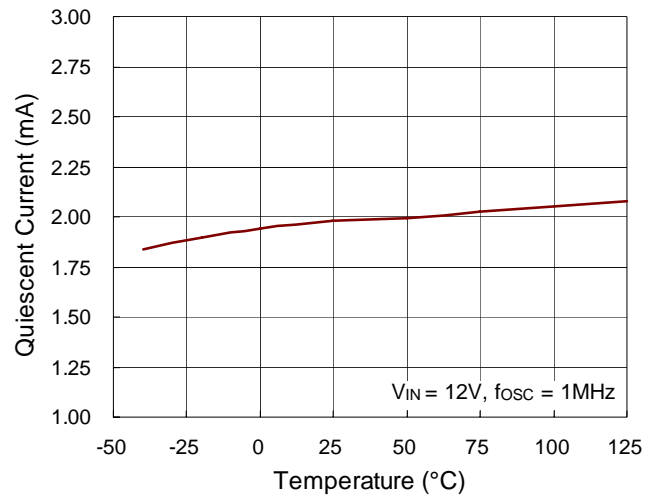

Line Transient Response

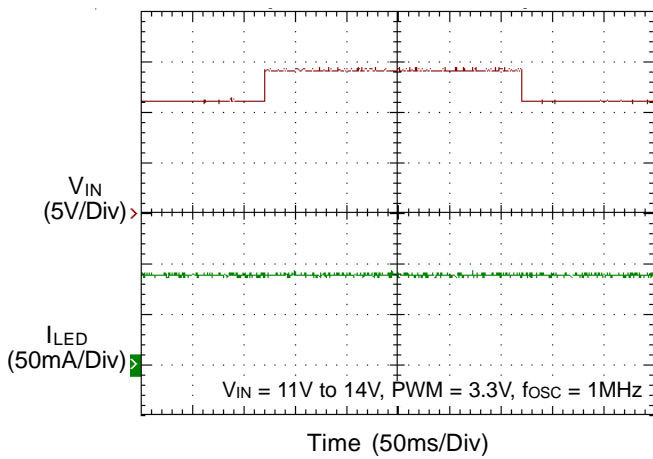

Line Transient Response

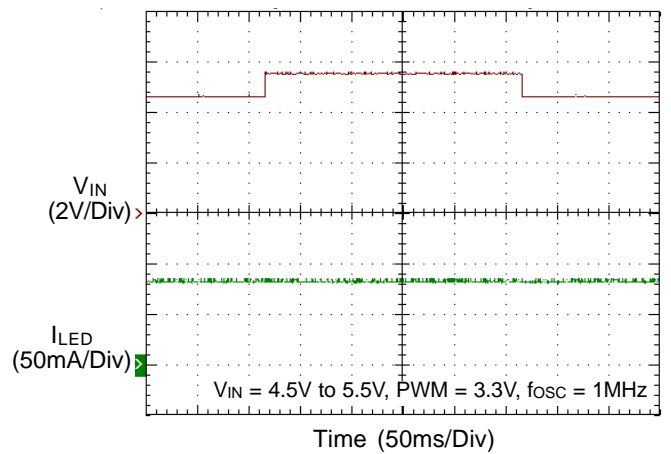

Power On from EN

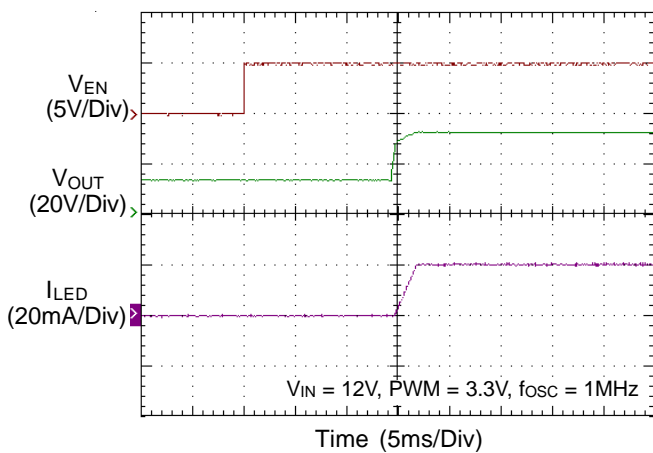

Power Off from EN

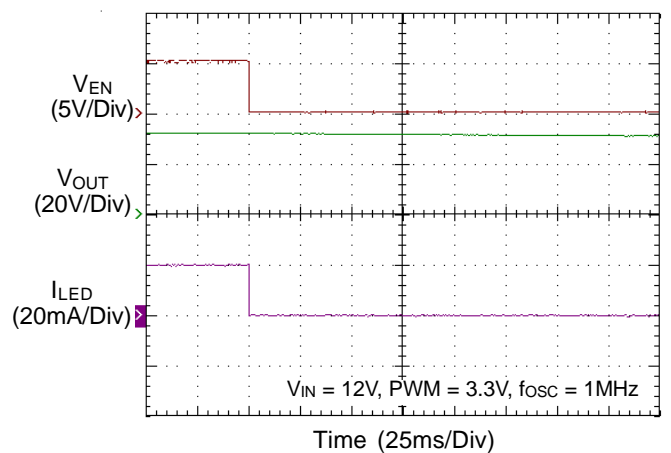

## Application Information

The RT8569 is a current mode boost converter capable of powering to 72 white LEDs with a programmable current for uniform intensity. The part integrates current sources, soft-start, and easy analog and digital dimming control. The protection block provides the circuitry for over temperature, over voltage and current limit protection features.

### Input UVLO

The input operating voltage range of the RT8569 is from 4.2V to 24V. An input capacitor at the VIN pin can reduce ripple voltage. It is recommended to use a ceramic 10μF or larger capacitance as the input capacitor. This IC provides an Under Voltage Lockout (UVLO) function to enhance the stability during startup. The UVLO threshold of the input rising voltage is set at 3.8V typically with a 0.2V hysteresis.

### Soft-Start

The function of the soft-start is defined by two periods. The first period is capped at the peak current limit with the time decided by the ratio of V<sub>OUT</sub> and V<sub>IN</sub>. However, an external capacitor, C<sub>OUT</sub>, can also affect the time of charging. The second period is defined by the slowly ramping of the I<sub>LED</sub> current by the V<sub>ISET</sub> voltage. Thus, the inrush current is limited by the boost converter and current regulator.

### Compensation

The control loop can be compensated by adjusting the external components connected to the COMP pin. The COMP pin is the output of the internal error amplifier. The compensation capacitors, C3 and C4, will adjust the zero and pole respectively to maintain stability. Moreover, the resistor, R3, will adjust the mid-band gain for fast transient response.

### LED Connection

The RT8569 equips 6-CH LED drivers with each channel supporting up to 12 LEDs. The 6 LED strings are connected from V<sub>OUT</sub> to pin 10, 11, 12, 13, 14, and 16 respectively. If one of the LED channels is not used, the unused LED pin should be opened directly.

### Setting and Regulation of LED Current

The LED current can be calculated by the following equation :

$$I_{LED} = \frac{1020}{R_{ISET}}$$

where, R<sub>ISET</sub> is the resistor between the ISET pin and GND.

This setting is the reference for the LED current at CH1 to CH6 and represents the sensed LED current for each string. The DC/DC converter regulates the LED current according to the setting.

### Brightness Control

The RT8569 brightness dimming is determined by the signal on the PWM pin with a suggested PWM frequency range from 200Hz to 25kHz. Referring to the following curve, the minimum dimming duty can be as low as 1% for the frequency range from 200Hz to 1kHz. For the frequency range from 1kHz to 10kHz, the dimming duty is at most 5%. If the frequency is increased to 25kHz, the dimming duty will be up to 10%.

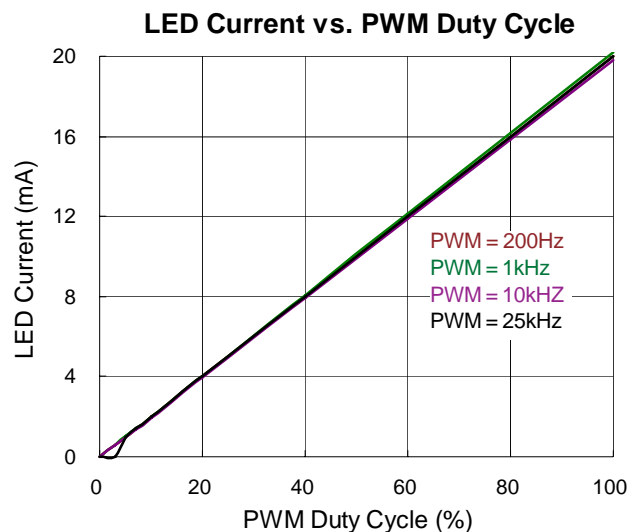

Figure 1

### Over Voltage Protection

The RT8569 equips an Over Voltage Protection (OVP) function. When the voltage at the OVP pin reaches a threshold of approximately 1.2V, the MOSFET driver turns off. The MOSFET driver turns on again once the voltage at OVP drops below the threshold voltage. Thus, the

output voltage can be clamped at a certain voltage level. This voltage level can be calculated by the following equation :

$$V_{OUT, OVP} = V_{OVP} \times \left( \frac{1 + R_{OVP2}}{R_{OVP1}} \right)$$

where  $R_{OVP1}$  and  $R_{OVP2}$  are the resistors in the voltage divider connected to the OVP pin. If at least one string is in normal operation, the controller will automatically ignore the open strings and continue to regulate the current for the string (s) in normal operation.

**Current Limit Protection**

The RT8569 can limit the peak current to achieve over current protection. The RT8569 senses the inductor current through LX pin in the ON period. The duty cycle depends on the current sense signal summed with the internal slope compensation and compared to the COMP signal. The internal N-MOSFET will be turned off when the current signal is larger than the COMP signal. In the OFF period, the inductor current will descend. The internal MOSFET is turned on by the oscillator in the next starting cycle.

**Over Temperature Protection**

The RT8569 has an Over Temperature Protection (OTP) function to prevent excessive power dissipation from overheating the device. The OTP will shut down switching operation when the junction temperature exceeds 150°C.

**Inductor Selection**

The value of the output inductor (L), where the transition from discontinuous to continuous mode occurs is approximated by the following equation :

$$L = \frac{(V_{OUT} - V_{IN}) \times V_{IN}^2}{2 \times I_{OUT} \times f \times V_{OUT}^2}$$

where,

$V_{OUT}$  = maximum output voltage.

$V_{IN}$  = minimum input voltage.

f = operating frequency.

$I_{OUT}$  = sum of current from all LED strings.

$\eta$  is the efficiency of the power converter.

The boost converter operates in discontinuous mode over the entire input voltage range when the L1 inductor value

is less than this value L. With an inductance greater than L, the converter operates in continuous mode at the minimum input voltage and may be discontinuous at higher voltages.

The selected inductor must be selected with saturation current rating greater than the peak current provided by the following equation :

$$I_{PEAK} = \left( \frac{V_{OUT} \times I_{OUT}}{\eta \times V_{IN}} \right) + \left( \frac{V_{IN} \times T}{2 \times L} \right) \times \left( \frac{V_{OUT} - V_{IN}}{V_{OUT}} \right)$$

**Diode Selection**

Schottky diode is a good choice for any asynchronous boost converter due to its small forward voltage and fast switching Speed. However, when selecting a Schottky diode, important parameters such as power dissipation, reverse voltage rating and pulsating peak current must all be taken into consideration. Choose a suitable diode with reverse voltage rating greater than the maximum output voltage.

**Capacitor Selection**

The input capacitor reduces current spikes from the input supply and minimizes noise injection to the converter. For most applications, a 10µF ceramic capacitor is sufficient. A value higher or lower may be used depending on the noise level from the input supply and the input current to the converter. It is recommended to choose a ceramic capacitor based on the output voltage ripple requirements. The minimum value of the output capacitor  $C_{OUT}$ , can be calculated by the following equation :

$$C_{OUT} = \frac{(V_{OUT} - V_{IN}) \times I_{OUT}}{\eta \times V_{RIPPLE} \times V_{OUT} \times f}$$

**Thermal Considerations**

For continuous operation, do not exceed absolute maximum junction temperature. The maximum power dissipation depends on the thermal resistance of the IC package, PCB layout, rate of surrounding airflow, and difference between junction and ambient temperature. The maximum power dissipation can be calculated by the following formula :

$$P_{D(MAX)} = (T_{J(MAX)} - T_A) / \theta_{JA}$$

where  $T_{J(MAX)}$  is the maximum junction temperature,  $T_A$  is the ambient temperature, and  $\theta_{JA}$  is the junction to ambient thermal resistance.

For recommended operating condition specifications of the RT8569, the maximum junction temperature is 125°C and T<sub>A</sub> is the ambient temperature. The junction to ambient thermal resistance, θ<sub>JA</sub>, is layout dependent. For WQFN-20L 4x4 packages, the thermal resistance, θ<sub>JA</sub>, is 54°C/W on a standard JEDEC 51-7 four-layer thermal test board. The maximum power dissipation at T<sub>A</sub> = 25°C can be calculated by the following formula :

$$P_{D(MAX)} = ( 125^{\circ}\text{C} - 25^{\circ}\text{C} ) / ( 54^{\circ}\text{C} / \text{W} ) = 1.852\text{W for WQFN-20L 4x4 package}$$

The maximum power dissipation depends on the operating ambient temperature for fixed T<sub>J(MAX)</sub> and thermal resistance, θ<sub>JA</sub>. For the RT8569 package, the derating curve in Figure 2 allows the designer to see the effect of rising ambient temperature on the maximum power dissipation.

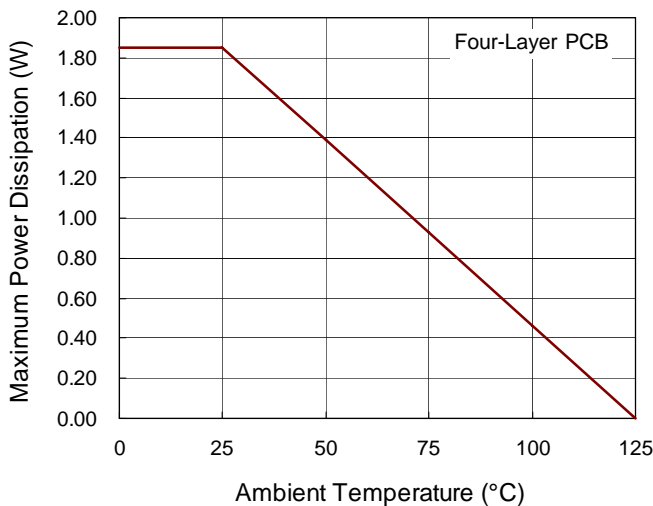

Figure 2. Derating Curve for RT8569 Package

Layout Considerations

PCB layout is very important for designing switching power converter circuits. The following layout guides should be strictly followed for best performance of the RT8569.

- ▶ The power components L1, D1, C<sub>IN</sub>, C<sub>OUT</sub> must be placed as close to the IC as possible to reduce current loop. The PCB trace between power components must be as short and wide as possible.
- ▶ Place L1 and D1 as close to the LX pin as possible. The trace should be as short and wide as possible.
- ▶ The compensation circuit should be kept away from the power loops and shielded with a ground trace to prevent any noise coupling. Place the compensation components as close to the COMP pin as possible.
- ▶ The exposed pad of the chip should be connected to ground plane for thermal consideration.

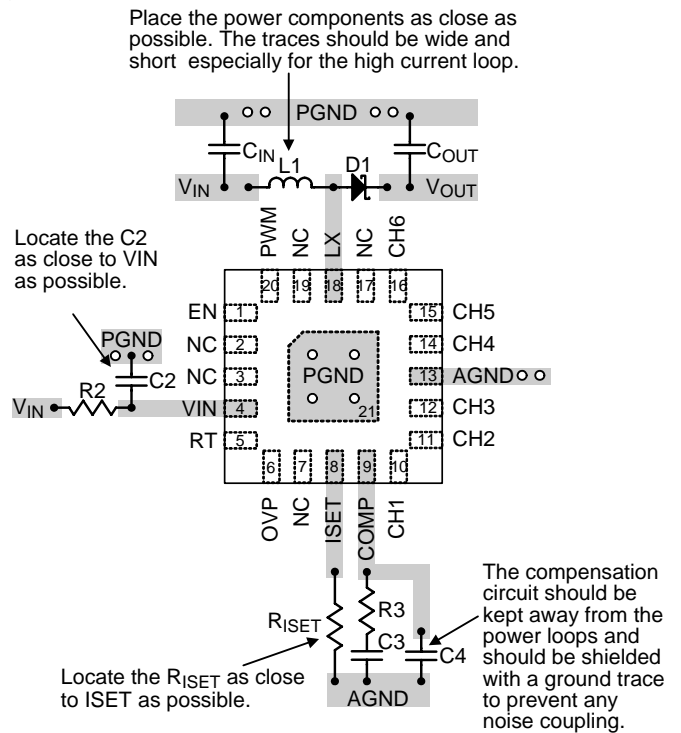
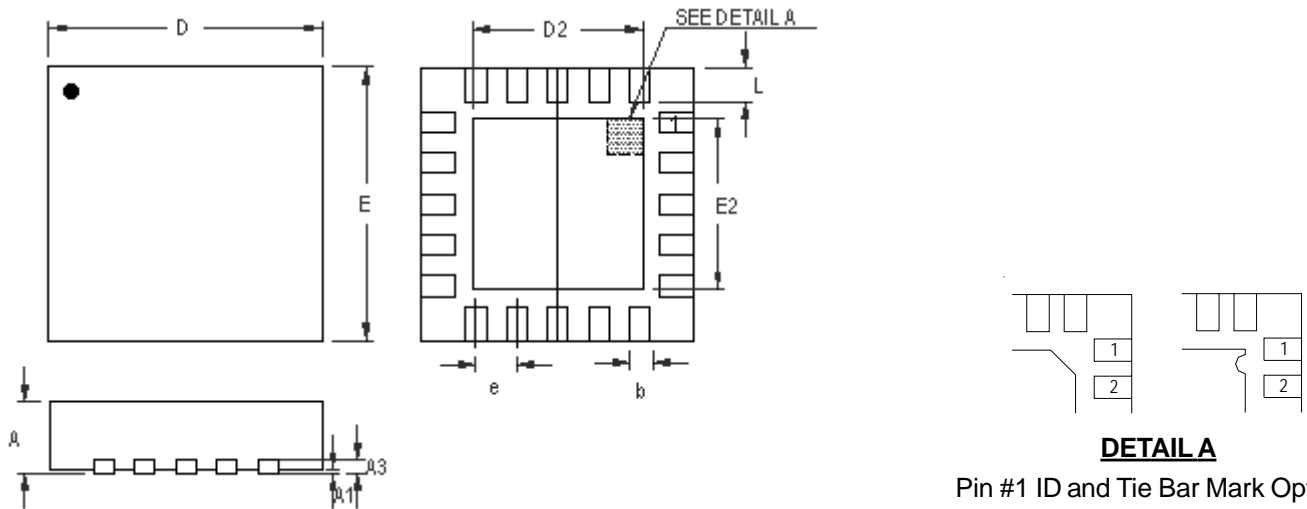

Figure 3. PCB Layout Guide

**Outline Dimension**



Pin #1 ID and Tie Bar Mark Options

Note : The configuration of the Pin #1 identifier is optional, but must be located within the zone indicated.

Symbol	Dimensions In Millimeters		Dimensions In Inches		
	Min	Max	Min	Max	
A	0.700	0.800	0.028	0.031	
A1	0.000	0.050	0.000	0.002	
A3	0.175	0.250	0.007	0.010	
b	0.150	0.300	0.006	0.012	
D	3.900	4.100	0.154	0.161	
D2	Option 1	2.650	2.750	0.104	0.108
	Option 2	2.100	2.200	0.083	0.087
E	3.900	4.100	0.154	0.161	
E2	Option 1	2.650	2.750	0.104	0.108
	Option 2	2.100	2.200	0.083	0.087
e	0.500		0.020		
L	0.350	0.450	0.014	0.018	

**W-Type 20L QFN 4x4 Package**

**Richtek Technology Corporation**

Headquarter  
5F, No. 20, Taiyuen Street, Chupei City  
Hsinchu, Taiwan, R.O.C.  
Tel: (8863)5526789 Fax: (8863)5526611



**Richtek Technology Corporation**

Taipei Office (Marketing)  
5F, No. 95, Minchiuan Road, Hsintien City  
Taipei County, Taiwan, R.O.C.  
Tel: (8862)86672399 Fax: (8862)86672377  
Email: marketing@richtek.com

Information that is provided by Richtek Technology Corporation is believed to be accurate and reliable. Richtek reserves the right to make any change in circuit design, specification or other related things if necessary without notice at any time. No third party intellectual property infringement of the applications should be guaranteed by users when integrating Richtek products into any application. No legal responsibility for any said applications is assumed by Richtek.

## Looking for pricing, stock, or lifecycle information?

Click below to explore more details on WIN SOURCE:

-  [View RT8569GQW on WIN SOURCE](#)
-  [Richtek USA Inc. Information](#)

## Optimize Your Supply Chain with WIN SOURCE Solutions

-  Global Sourcing Solution
-  Obsolete Management
-  Cost Control Management
-  Shortage Management
-  Alternative Solution
-  Excess Inventory Management