



THE DATASHEET OF RS3KB



Features

- Glass Passivated Die Construction
- Fast Recovery Time for High Efficiency
- Low Forward Voltage Drop and High Current Capability
- Surge Overload Rating to 100A Peak
- Ideally Suited for Automatic Assembly
- Plastic Material: UL Flammability Classification Rating 94V-0

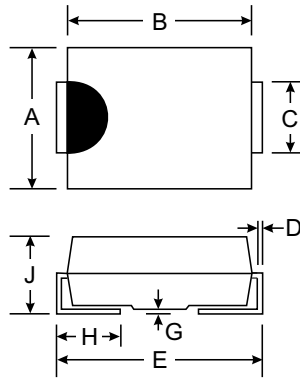

Dim	SMB		SMC	
	Min	Max	Min	Max
A	3.30	3.94	5.59	6.22
B	4.06	4.57	6.60	7.11
C	1.96	2.21	2.75	3.18
D	0.15	0.31	0.15	0.31
E	5.00	5.59	7.75	8.13
G	0.10	0.20	0.10	0.20
H	0.76	1.52	0.76	1.52
J	2.00	2.62	2.00	2.62
All Dimensions in mm				

Mechanical Data

- Case: Molded Plastic
- Terminals: Solder Plated Terminal - Solderable per MIL-STD-202, Method 208
- Polarity: Cathode Band or Cathode Notch
- Marking: Type Number
- SMB Weight: 0.09 grams (approx.)
- SMC Weight: 0.20 grams (approx.)

AB, BB, DB, GB, JB, KB, MB Suffix Designates SMB Package
A, B, D, G, J, K, M Suffix Designates SMC Package

Maximum Ratings and Electrical Characteristics @ T_A = 25°C unless otherwise specified

Single phase, half wave, 60Hz, resistive or inductive load.
For capacitive load, derate current by 20%.

Characteristic	Symbol	RS3 A/AB	RS3 B/BB	RS3 D/DB	RS3 G/GB	RS3 J/JB	RS3 K/KB	RS3 M/MB	Unit
Peak Repetitive Reverse Voltage	V _{RRM}	50	100	200	400	600	800	1000	V
Working Peak Reverse Voltage	V _{RWM}								
DC Blocking Voltage	V _R								
RMS Reverse Voltage	V _{R(RMS)}	35	70	140	280	420	560	700	V
Average Rectified Output Current @ T _T = 75°C	I _O	3.0							A
Non-Repetitive Peak Forward Surge Current 8.3ms Single half sine-wave Superimposed on Rated Load (JEDEC Method)	I _{FSM}	100							A
Forward Voltage @ I _F = 3.0A	V _{FM}	1.3							V
Peak Reverse Current @ T _A = 25°C at Rated DC Blocking Voltage @ T _A = 125°C	I _{RM}	5.0 250							μA
Maximum Recovery Time (Note 3)	t _{rr}	150				250	500		ns
Typical Junction Capacitance (Note 2)	C _j	50							pF
Typical Thermal Resistance Junction to Terminal (Note 1)	R _{θJT}	25							K/W
Operating and Storage Temperature Range	T _j , T _{STG}	-65 to +150							°C

- Notes:
1. Thermal resistance: junction to terminal, unit mounted on PC board with 5.0 mm² (0.013 mm thick) copper pad as heat sink.
 2. Measured at 1.0MHz and applied reverse voltage of 4.0V DC.
 3. Reverse recovery test conditions: I_F = 0.5A, I_R = 1.0A, I_{rr} = 0.25A. See figure 5.

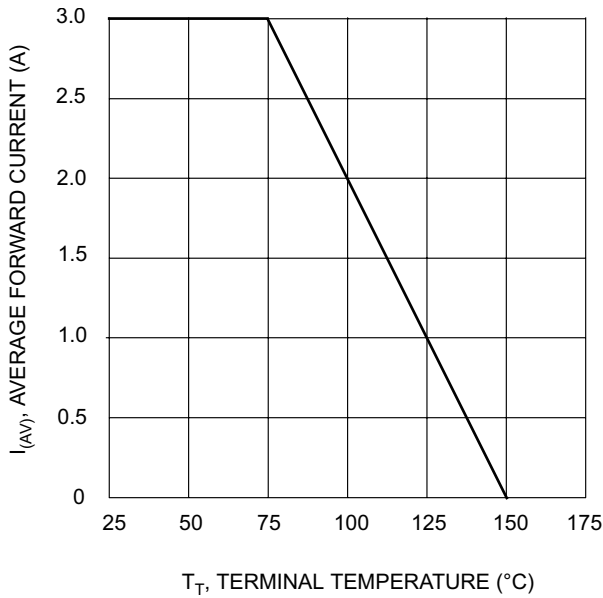

Fig. 1 Forward Current Derating Curve

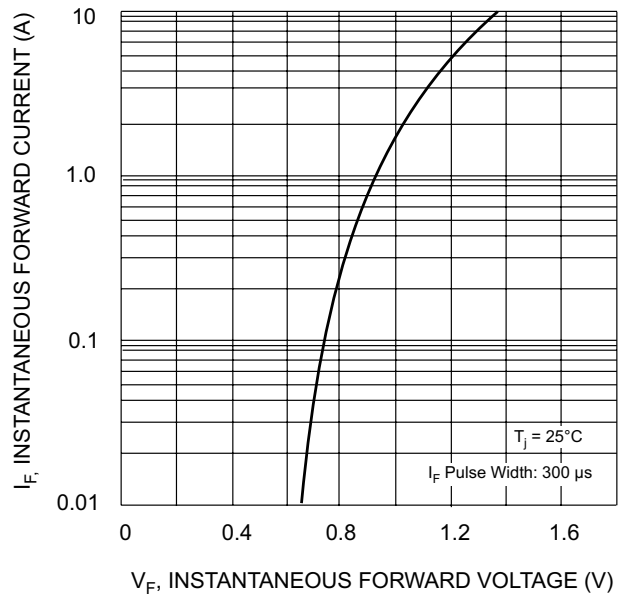

Fig. 2 Typical Forward Characteristics

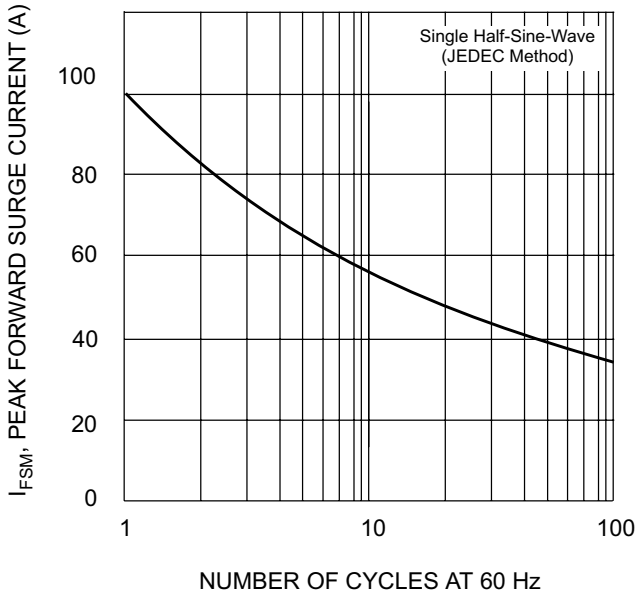

Fig. 3 Forward Surge Current Derating Curve

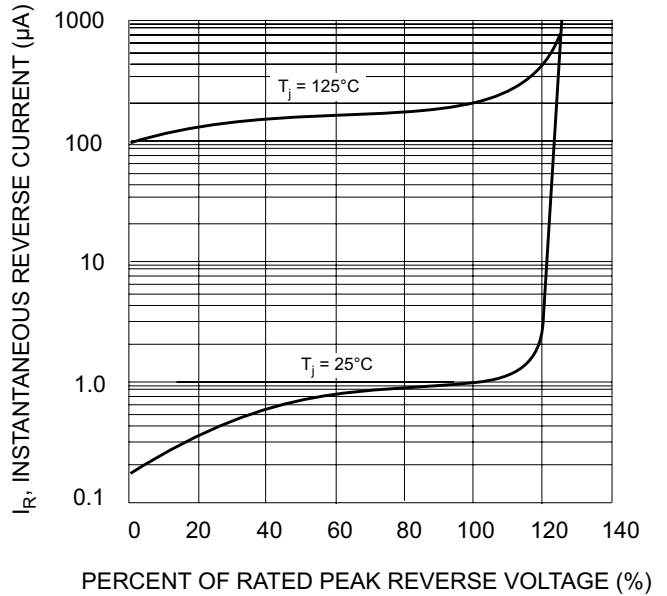
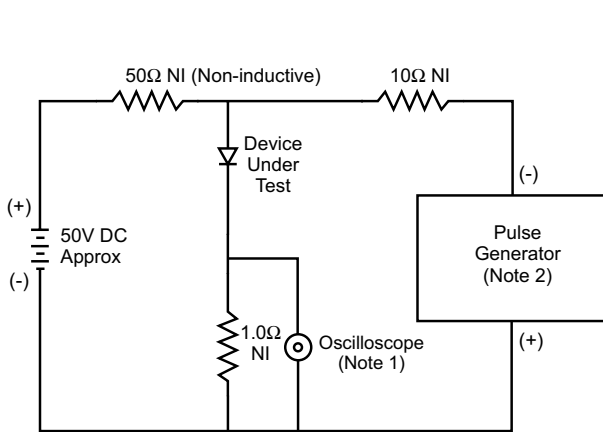
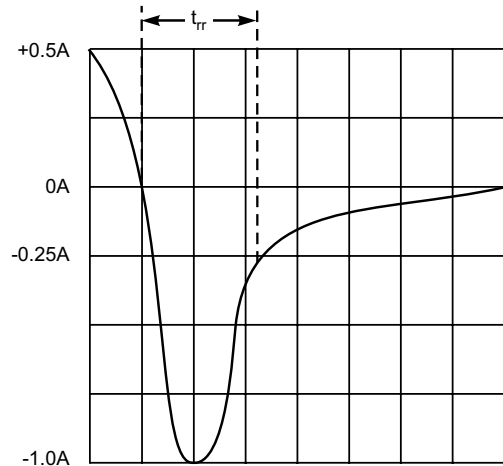

Fig. 4 Typical Reverse Characteristics



- Notes:
1. Rise Time = 7.0ns max. Input Impedance = 1.0MΩ, 22pF.
 2. Rise Time = 10ns max. Input Impedance = 50Ω.



Set time base for 50/100 ns/cm

Fig. 5 Reverse Recovery Time Characteristic and Test Circuit

Looking for pricing, stock, or lifecycle information?

Click below to explore more details on WIN SOURCE:

-  [View RS3KB on WIN SOURCE](#)
-  [Diodes Incorporated Information](#)

Optimize Your Supply Chain with WIN SOURCE Solutions

-  Global Sourcing Solution
-  Obsolete Management
-  Cost Control Management
-  Shortage Management
-  Alternative Solution
-  Excess Inventory Management