



THE DATASHEET OF
5B30-02



FEATURES

Isolated Voltage Input.

Amplifies, Protects, Filters, & Isolates Analog Input Voltages.
Protect the computer side from damage due to field-side overvoltage faults.

A Series output switch eliminates the need for external multiplexing in many applications.

Module circuitry can withstand 240v rms at the input screw-terminals.

All 5B30 & 5B31 series modules are mix-and-match and Hot Swappable.

APPLICATIONS

Industrial signal conditioning
Industrial signal isolation
Industrial signal filtering

PRODUCT OVERVIEW

The 5B Series represents an innovative generation of low cost, high performance plug-in signal conditioners. Designed for industrial applications, these modules incorporate highly reliable transformer-based isolation and automated surface-mount manufacturing technology. They are compact, economical components whose performance exceeds that available from more expensive devices. Combining 1500 V rms continuous isolation, +0.05% calibrated accuracy, small size and low cost, the 5B Series is an attractive alternative to expensive signal conditioners and in-house designs

All modules are potted and identical in pin-out and size (2.27" x 2.32" x 0.595"). They can be mixed and matched, permitting users to address their exact needs, and may be "hot swapped" without disturbing field wiring or power. The isolated input modules provide 0 to +5V or +5V outputs and accept J, K, T, E, R, S, N, or B type thermocouples.

These modules feature complete signal conditioning functions including 240 V rms input protection, filtering, chopper stabilized low drift +1 uV/oC amplification, 1500 V rms isolation, and sensor excitation when required.

All modules feature excellent common mode rejection and meet industrial transient surge withstand specifications.

FUNCTIONAL BLOCK DIAGRAM

Rev. 0

Information furnished by Analog Devices is believed to be accurate and reliable. However, no responsibility is assumed by Analog Devices for its use, nor for any infringements of patents or other rights of third parties that may result from its use. Specifications subject to change without notice. No license is granted by implication or otherwise under any patent or patent rights of Analog Devices. Trademarks and registered trademarks are the property of their respective companies.

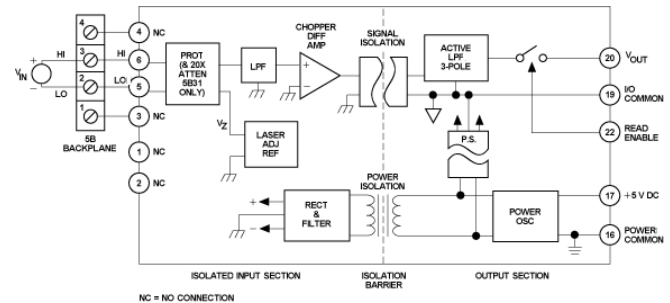

Figure 1. 5B30/5B31 Functional Block Diagram

There are also a number of backplanes and mounting sockets which provide a complete signal conditioning solution for end users. Each backplane incorporates screw terminals for field wiring inputs and outputs and cold junction sensors for thermocouple applications.

These signal conditioners are designed to provide an easy and convenient solution to signal conditioning problems of both designers and end users in measurement and control applications. Typical uses include microcomputer-based measurement systems, standard data acquisition systems, programmable controllers, analog recorders and dedicated control systems. The 5 B series modules are ideally suited to applications where monitoring and control of temperature, pressure, flow, rotation and other analog signals are required.

The 5B Series modules and backplanes are approved by Factory Mutual (FM) and the 5B Series modules are approved by the Canadian Standards Association (CSA) for use in Class 1, Division 2, Groups A, B, C, and D locations. These approvals certify that the 5B Series is suitable for use in locations where a hazardous concentration of flammable gas may exist only under fault conditions of operation. Equipment of this category is called "non-incendive" and they need no special enclosures or other physical safeguards.

The 5B series modules and backplanes have been tested and passed the stringent heavy industrial requirements of the European Union's electromagnetic compatibility (EMC) directive – EN50082-1 and EN50081-2. When used according to installation directions (refer to 5B series User Manual), any errors caused by EMI/RFI interference will be less than 0.1% of the full scale 5B measurement range for field strengths up to 10 V/M and frequencies up to 1 GHz.

GENERAL DESCRIPTION

The 5B30 and 5B31 are single-channel signal conditioning modules that amplify, protect, filter and isolate analog input voltages.

The 5B30 and 5B31 protect the computer side from damage due to field-side over voltage faults. All models withstand 240V rms at their input terminals without damage thereby shielding computer side circuitry from field-side over voltage conditions. In addition, 5B30 and 5B31 Series modules are mix-and-match and hot swappable, so can be inserted or removed from any socket in the same backplane without disrupting system power.

A chopper-stabilized input amplifier provides low drift and stable gain. At the amplifier input, a stable, laser-trimmed zero-scale input voltage is subtracted from the input signal to set the zero scale value. For user convenience, the zero can be optionally factory-set to meet custom needs. This allows suppression of a zero-scale input value many times larger than the total span for precise expanded-scale measurements.

Internal multi-pole low-pass filtering with a four-Hz cutoff (-3dB) enhances normal-mode (noise on signal) and common-

mode (noise on signal return) rejection at 50/60 Hz, enabling accurate measurement of small signals in high electrical noise.

Signal isolation by transformer coupling uses a proprietary modulation technique for linear, stable and reliable performance. The differential input circuit on the field side is fully floating, eliminating the need for any input grounding. A demodulator on the computer side of the signal transformer recovers the original signal, which is then filtered and buffered to provide a low-noise, low-impedance output signal. The output common must be kept within ± 3 V of power common.

A series output switch eliminates the need for external multiplexing in many applications. The switch is turned on by an active-low enable input. If the switch is to be on at all times, the enable-input should be grounded to power common as it is on the 5B01 and 5B08 backplanes.



Figure 2

5B30 / 5B31—SPECIFICATIONS

5B30 and 5B31 Models Available

Model	Input Range	Output Range
5B30-01	-10 mV to +10 mV	-5 V to +5 V
5B30-02	-50 mV to +50 mV	-5 V to +5 V
5B30-03	-100 mV to +100 mV	-5 V to +5 V
5B30-04	-10 mV to +10 mV	0 V to +5 V
5B30-05	-50 mV to +50 mV	0 V to +5 V
5B30-06	-100 mV to +100 mV	0 V to +5 V
5B30-Custom	*	*

Model	Input Range	Output Range
5B31-01	-1 V to +1 V	-5 V to +5 V
5B31-02	-5 V to +5 V	-5 V to +5 V
5B31-03	-10 V to +10 V	-5 V to +5 V
5B31-04	-1 V to +1 V	0 V to +5 V
5B31-05	-5 V to +5 V	0 V to +5 V
5B31-06	-10 V to +10 V	0 V to +5 V
5B31-07	-20 V to +20 V	-5 V to +5 V
5B31-Custom	*	*

*Custom Input/Output ranges are available. Refer to configuration guide.

5B30 and 5B31 Specifications

Description	Model 5B30	Model 5B31
Input Ranges		
Standard Ranges	±10 mV to ±100 mV	±1 V to ±20 V
Custom Ranges	±5 mV to ±500 mV	±0.5 V to ±20 V
Output Ranges ($R_L > 50 \text{ k}\Omega$) ⁴	-5 V to +5 V or 0 V to +5 V	*
Accuracy²		
Initial @ +25°C	±0.05% Span ±10 μV RTI ±0.05% (V_Z) ¹	±0.05% Span ±0.2 mV RTI ±0.05% (V_Z) ¹
Nonlinearity	±0.02% Span	*
Input Offset vs. Temperature	±1 $\mu\text{V}/^\circ\text{C}$	±20 $\mu\text{V}/^\circ\text{C}$
Output Offset vs. Temperature	±20 $\mu\text{V}/^\circ\text{C}$	*
Gain vs. Temperature	±25 ppm of Reading/ $^\circ\text{C}$	±50 ppm of Reading/ $^\circ\text{C}$
Input Bias Current	±3 nA	±0.2 nA
Input Resistance		
Power On	5 M Ω	650 k Ω
Power Off	40 k Ω	650 k Ω

Overload	40 k Ω	650 k Ω
Noise		
Input, 0.1 Hz to 10 Hz Bandwidth	0.2 μ V rms	2 μ V rms
Output, 100 kHz Bandwidth	200 μ V rms	*
Bandwidth, -3 dB	4 Hz	*
Output Rise Time, 10% to 90% Span	200 ms	*
Common-Mode Voltage (CMV)³		
Input-to-Output, Continuous	1500 V rms maximum	*
Output-to-Power, Continuous	\pm 3 V maximum	*
Transient	ANSI/IEEE C37.90.1-1989	*
Common-Mode Rejection (CMR)		
1 k Ω Source Imbalance, 50/60 Hz	160 dB (all ranges)	160 dB (span < \pm 2 V) 150 dB (span = \pm 10 V)
Normal Mode Rejection, 50/60 Hz	60 dB	*
Input Protection		
Continuous	240 V rms maximum	*
Transient	ANSI/IEEE C37.90.1-1989	*
Output Resistance ⁴	50 Ω	*
Voltage Output Protection	Continuous Short to Ground	*
Output Selection Time	6 μ s @ C _{load} = 0 to 2,000 pF	*
Output Enable Control		
Max Logic "0"	+1 V	*
Min Logic "1"	+2.5 V	*
Max Logic "1"	+36 V	*
Input Current "0"	0.4 mA	*
Power Supply Voltage	+5 V \pm 5%	*
Power Supply Current	30 mA	*
Power Supply Sensitivity, RTI	\pm 2 μ V/Vs%	\pm 0.4 mV/Vs%
Mechanical Dimensions	2.275" x 2.375" x 0.595" (57.8 mm x 59.1 mm x 15.1 mm)	*
Environmental		
Temperature Range		
Rated Performance	-25°C to +85°C	*
Operating	-40°C to +85°C	*
Storage	-40°C to +85°C	*
Relative Humidity	0 to 93% @ +40°C non-condensing	*
RFI Susceptibility	\pm 0.5% Span error @ 400 MHz, 5 Watt, 3 ft	*

* Specifications same as model 5B30.

¹ Vz is the nominal input voltage that results in a 0 V output.² Includes the combined effects of repeatability, hysteresis, and nonlinearity and assumes R_L > 50 k Ω .³ The output common must be kept within \pm 3 V of power common.⁴ Loads heavier than 50 k Ω will degrade nonlinearity and gain temperature coefficient.

Specifications subject to change without notice.

PIN CONFIGURATIONS AND FUNCTIONAL DESCRIPTIONS

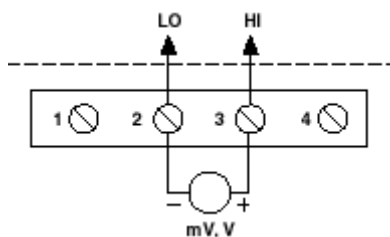

Figure 3 5B30/5B31 Input Field Connections

Table 1. Pin Function Descriptions—

Pin No.	Description
1	NC
2	LOW -
3	HIGH +
4	NC

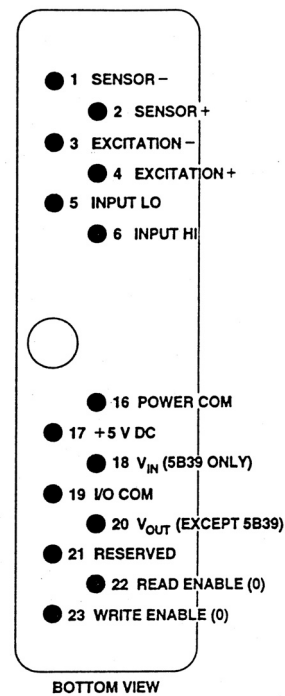
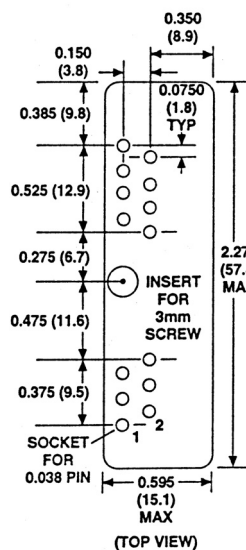

Figure 4 . Model 5B Series Module, with pin-out assignments.

ESD CAUTION

ESD (electrostatic discharge) sensitive device. Electrostatic charges as high as 4000 V readily accumulate on the human body and test equipment and can discharge without detection. Although this product features proprietary ESD protection circuitry, permanent damage may occur on devices subjected to high energy electrostatic discharges. Therefore, proper ESD precautions are recommended to avoid performance degradation or loss of functionality.



OUTLINE DIMENSIONS

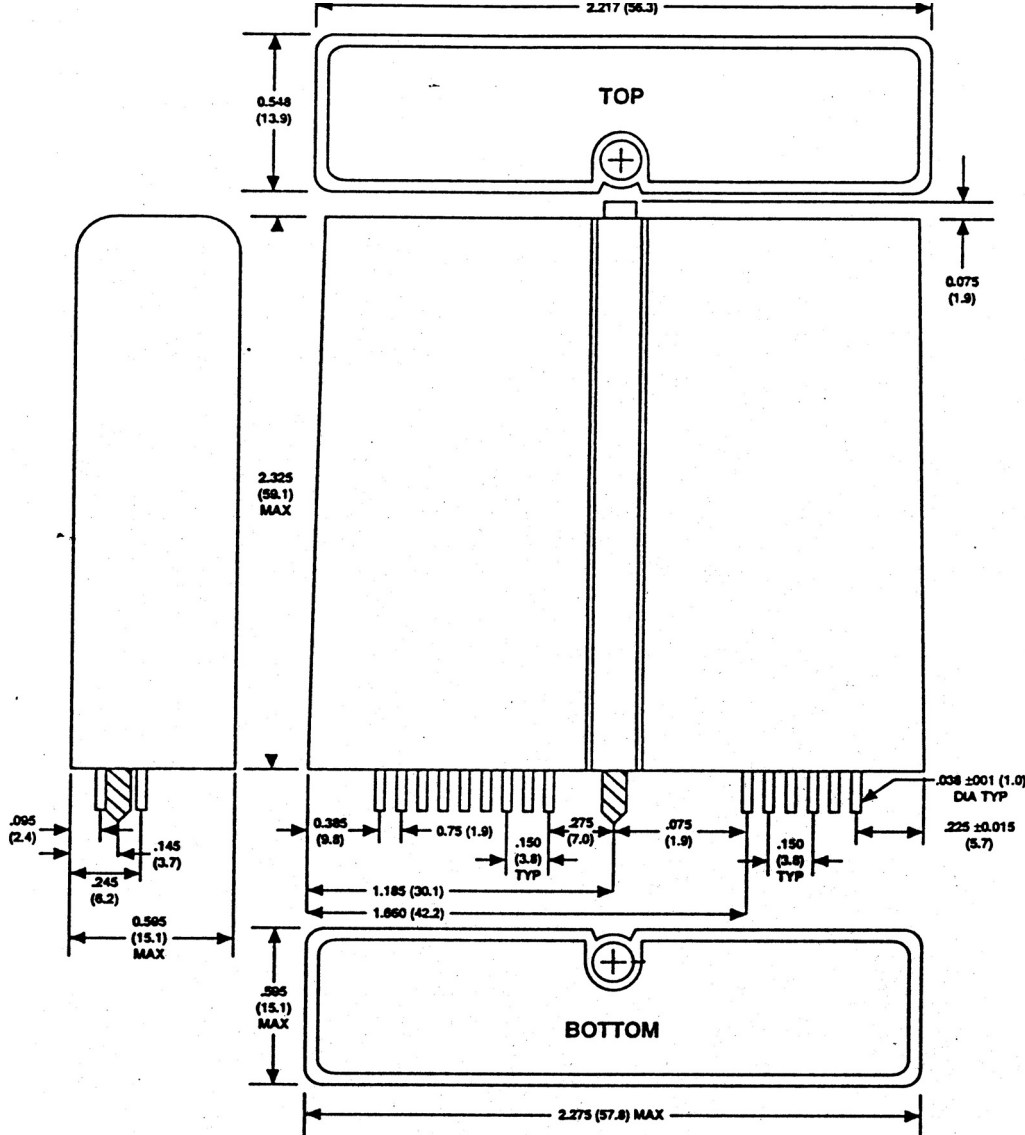



Figure 5. Outline Dimensions

NOTES

NOTES

Looking for pricing, stock, or lifecycle information?

Click below to explore more details on WIN SOURCE:

-  [View 5B30-02 on WIN SOURCE](#)
-  [Analog Devices Inc. Information](#)

Optimize Your Supply Chain with WIN SOURCE Solutions

-  Global Sourcing Solution
-  Obsolete Management
-  Cost Control Management
-  Shortage Management
-  Alternative Solution
-  Excess Inventory Management