



THE DATASHEET OF
5988091107F



Dialight

Micro LED® SMD LED “598 SERIES” 0603 PACKAGE (1.6mm X 0.8mm X 0.7mm) Single Color

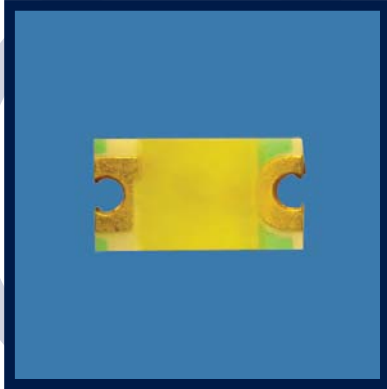

FEATURES / BENEFITS

- ▲ Compatible with automatic placement equipment
- ▲ RoHS compliant
- ▲ Packaged in 8mm tape, 7” reel and 20 per strip
- ▲ MSL 3
- ▲ Meets EIA-481-1 pkg. std.

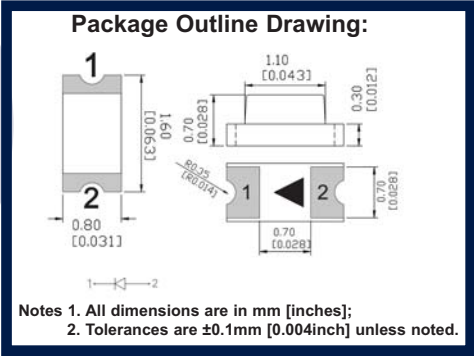

ORDERING INFORMATION

5 9 8 - 8 0 1 0 - 1 0 **7** F
Packaging Option

2	20 pieces on tape
7	7” reel 4000pcs / reel

PART NUMBERS

DIALIGHT P/N	EMITTED COLOR	MATERIAL	LENS COLOR	LUMINOUS INTENSITY			DOMINANT WAVELENGTH			FORWARD VOLTAGE			VIEWING ANGLE
				mcd @ If = 20 ma			nm @ If = 20 ma			V @ If = 20 ma			° DEGREES
				MIN	TYP	MAX	MIN	TYP	MAX	MIN	TYP	MAX	
598-8010-107F	RED	AllnGaP	Water Clear	40	60	80	630	635	640	1.8	2	2.4	140
598-8020-107F	RED-ORANGE	AllnGaP	Water Clear	150	240	330	620	625	630	1.8	2	2.2	140
598-8030-107F	ORANGE	AllnGaP	Water Clear	90	120	150	600	605	610	1.8	2	2.2	140
598-8040-107F	YELLOW	AllnGaP	Water Clear	80	140	200	590	593	595	1.8	2	2.2	140
598-8050-107F	YELLOW	AllnGaP	Water Clear	80	140	200	585	588	590	1.8	2	2.2	140
598-8060-107F	YELLOW-GREEN	AllnGaP	Water Clear	28	40	60	567	571	575	1.8	2	2.4	140
598-8070-107F	GREEN	GaP	Water Clear	10	20	40	565	568	570	1.8	2	2.4	140
598-8081-107F	GREEN	InGaP	Water Clear	260	340	430	520	523	525	2.8	3.2	3.5	140
598-8091-107F	BLUE	InGaP	Water Clear	90	140	200	465	470	475	2.9	3.2	3.5	140

ABSOLUTE RATINGS (@ Ta = 25°C)

DIALIGHT P/N	Power Dissipation	Forward Current	Reverse Voltage	Operating Temperature Range	Storage Temperature Range	Peak Pulse Forward Current	Electrostatic Discharge
	(mW)	(mA)	(V)	(°C)	(°C)	(mA)	(V)
598-8010-107F	60	25	5	-40~+100	-40~+100	100	2000(HBM)
598-8020-107F	55	25	5	-40~+100	-40~+100	100	2000(HBM)
598-8030-107F	55	25	5	-40~+100	-40~+100	100	2000(HBM)
598-8040-107F	55	25	5	-40~+100	-40~+100	100	2000(HBM)
598-8050-107F	55	25	5	-40~+100	-40~+100	100	2000(HBM)
598-8060-107F	60	25	5	-40~+100	-40~+100	100	2000(HBM)
598-8070-107F	60	25	5	-40~+100	-40~+100	100	2000(HBM)
598-8081-107F	70	20	5	-40~+100	-40~+100	100	1000(HBM)
598-8091-107F	70	20	5	-40~+100	-40~+100	100	1000(HBM)



MECHANICAL DIMENSIONS

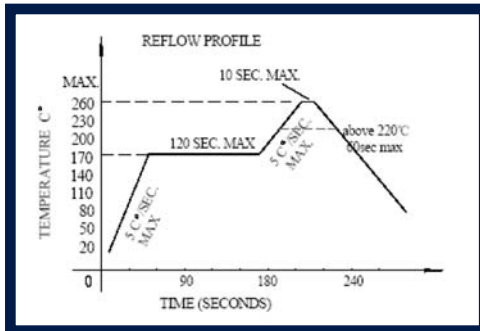
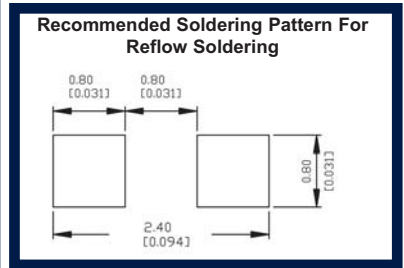
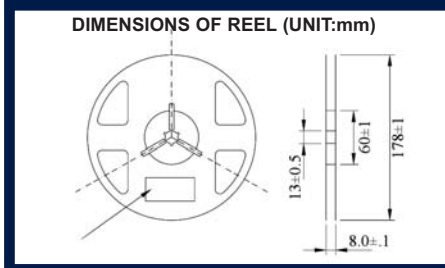
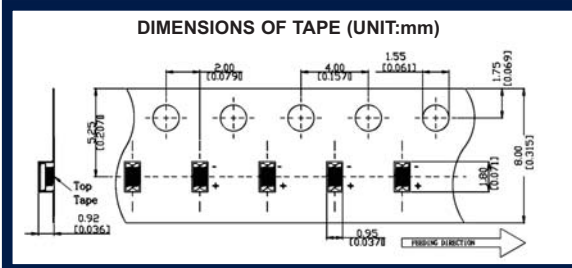

REFLOW SOLDERING		HAND SOLDERING	
Pre-heat	160~180°C	Temperature	300°C Max.
Pre-heat time	120 seconds Max.		
Peak temperature	260°C Max.	Soldering time	3 second Max (one time only)
Soldering time	10 seconds Max.		
Condition	Refer to temperature -profile		

OPTICAL AND ELECTRICAL CHARACTERISTICS CURVES

RED 630-640NM, RED-ORANGE 620-630NM, ORANGE 600-610NM, YELLOW 590-595NM, YELLOW 585-590NM, YELLOW GREEN 567-575NM, GREEN 565-570NM

FORWARD VOLTAGE VS FORWARD CURRENT (Ta=25°C)

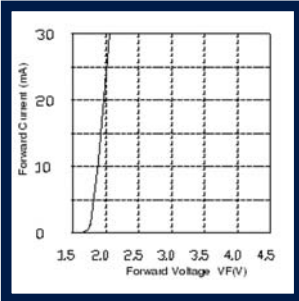

RELATIVE INTENSITY VS FORWARD CURRENT (Ta=25°C)

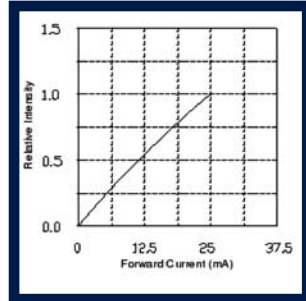

DERATING

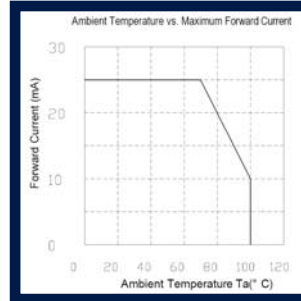

RELATIVE INTENSITY VS AMBIENT TEMPERATURE

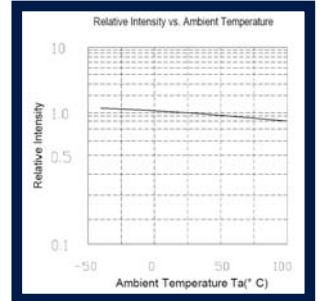

GREEN 520-525NM, BLUE 465-475NM

FORWARD VOLTAGE VS FORWARD CURRENT (Ta=25°C)

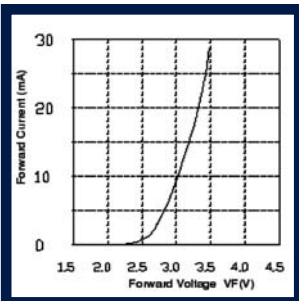

RELATIVE INTENSITY VS FORWARD CURRENT (Ta=25°C)

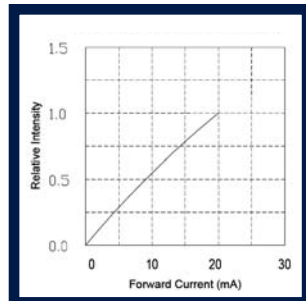

DERATING

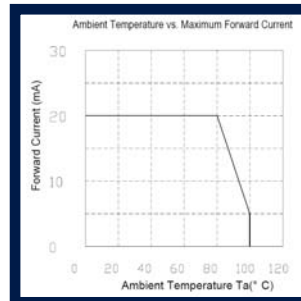

RELATIVE INTENSITY VS AMBIENT TEMPERATURE

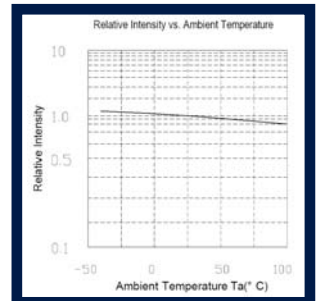

Dialight reserves the right to make changes at any time in order to supply the best product possible.

The most current version of this document will always be available at:
www.dialight.com/Assets/Brochures_And_Catalogs/Illumination/MDTFSFSTHB001.pdf

Looking for pricing, stock, or lifecycle information?

Click below to explore more details on WIN SOURCE:

 [View 5988091107F on WIN SOURCE](#)

 [Dialight Information](#)

Optimize Your Supply Chain with WIN SOURCE Solutions

-  Global Sourcing Solution
-  Obsolete Management
-  Cost Control Management
-  Shortage Management
-  Alternative Solution
-  Excess Inventory Management